

Product Overview

The CMD226C3 is a broadband MMIC GaAs x2 passive frequency multiplier in a ceramic, QFN-style package. When driven by a +15 dBm signal, the multiplier provides 10.5 dB conversion loss at an output frequency of 18 GHz. The Fo and 3Fo isolations are 44 dBc and 46 dBc respectively. The CMD226C3 is a 50 ohm matched design eliminating the need for RF port matching.

Functional Block Diagram

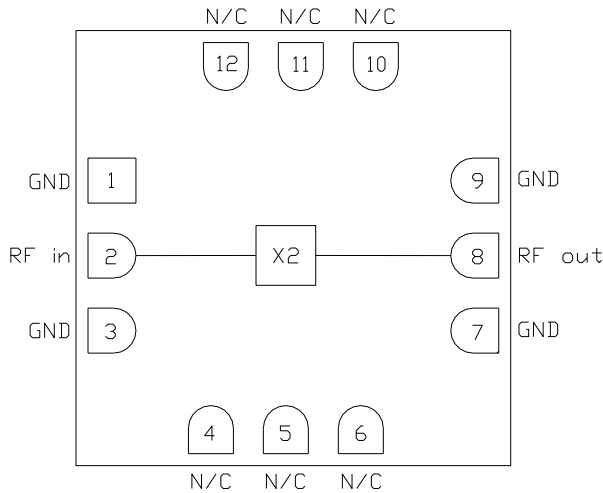

Key Features

- Low Conversion Loss
- Excellent Fo Isolation
- Broadband Performance
- No Bias Required

Ordering Information

Part No.	Description
CMD226C3	Frequency Doubler, 7-11 GHz Input, 100 Piece 7" Reel
CMD226C3-EVB	Evaluation Board

Electrical Performance (TA = 25 °C, Pin = +15 dBm, Fin = 9 GHz)

Parameter	Min	Typ	Max	Units
Frequency Range, Input		7 - 11		GHz
Frequency Range, Output		14 - 22		GHz
Conversion Loss		9		dB
Fo Isolation (with respect to input level)		44		dB
3Fo Isolation (with respect to input level)		48		dB
4Fo Isolation (with respect to input level)		50		dB

Absolute Maximum Ratings

Parameter	Rating
RF Input Power	+22 dBm
Operating Temperature	-40 to 85 °C
Storage Temperature	-55 to 150 °C
Thermal Resistance, θ_{JC}	689.2 °C/W

Exceeding any one or combination of the maximum ratings may cause permanent damage to the device.

Electrical Specifications ($T_A = 25\text{ °C}$, $P_{in} = +15\text{ dBm}$)

Parameter	Min	Typ	Max	Min	Typ	Max	Units
Frequency Range, Input	7 - 11			8 - 10			GHz
Frequency Range, Output	14 - 22			16 - 20			GHz
Conversion Loss		11	17		10.5	13	dB
Fo Isolation (with respect to input level)	33	44		33	44		dB
3Fo Isolation (with respect to input level)	37	50		45	52		dB
4Fo Isolation (with respect to input level)	22	45		35	45		dB

Typical Performance

Conversion Gain vs. Temperature @ +15 dBm Drive Level

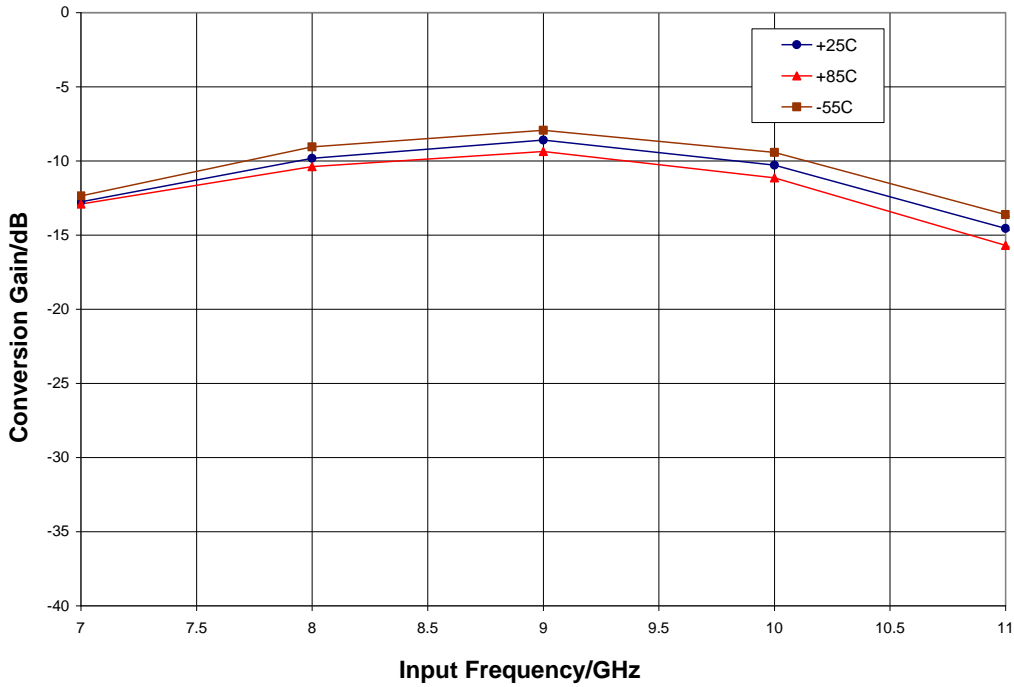

Conversion Gain vs. Drive Level, T_A = 25 °C

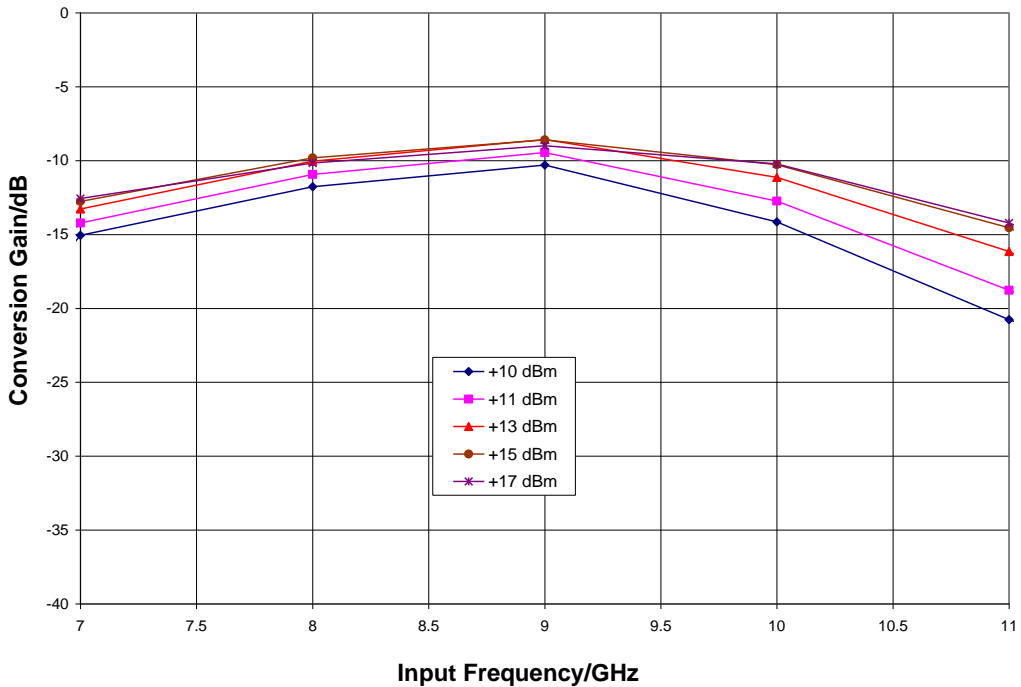

Typical Performance

Isolation (with respect to input level) @ +15 dBm Drive Level, $T_A = 25\text{ }^\circ\text{C}$

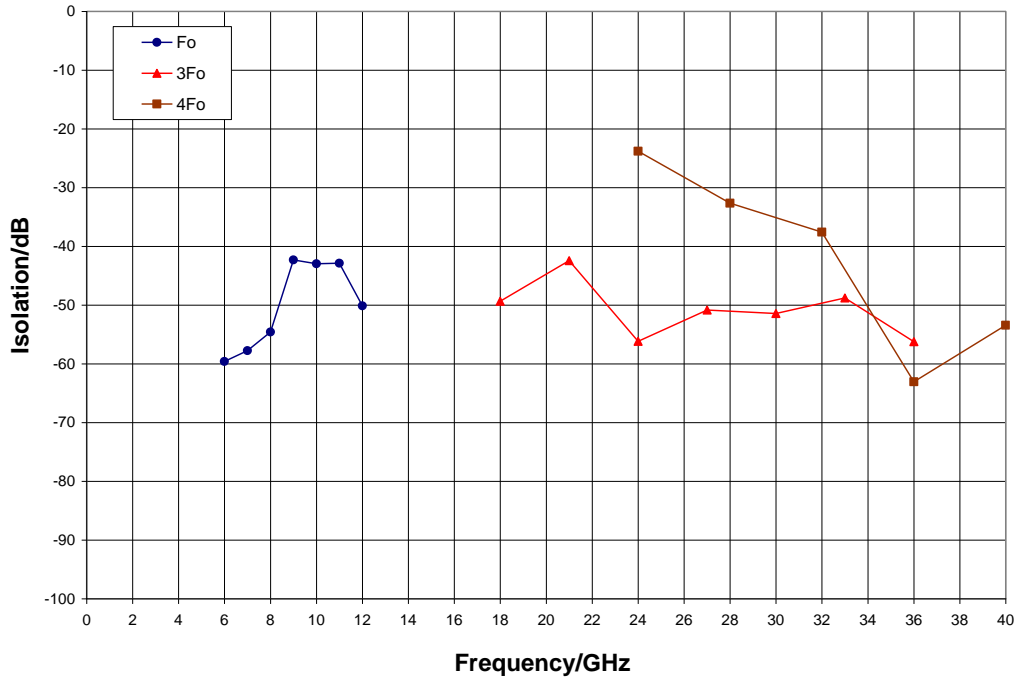

Output Spectrum @ +15 dBm Drive Level, $T_A = 25\text{ }^\circ\text{C}$

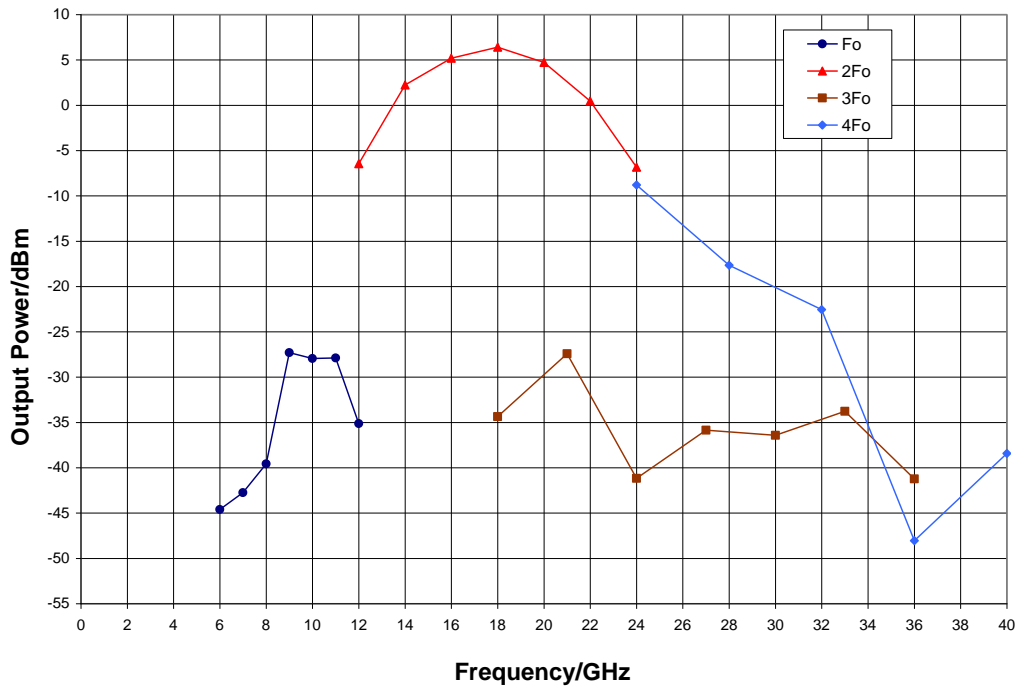

Typical Performance

Input Return Loss @ +15 dBm Drive Level, T_A = 25 °C

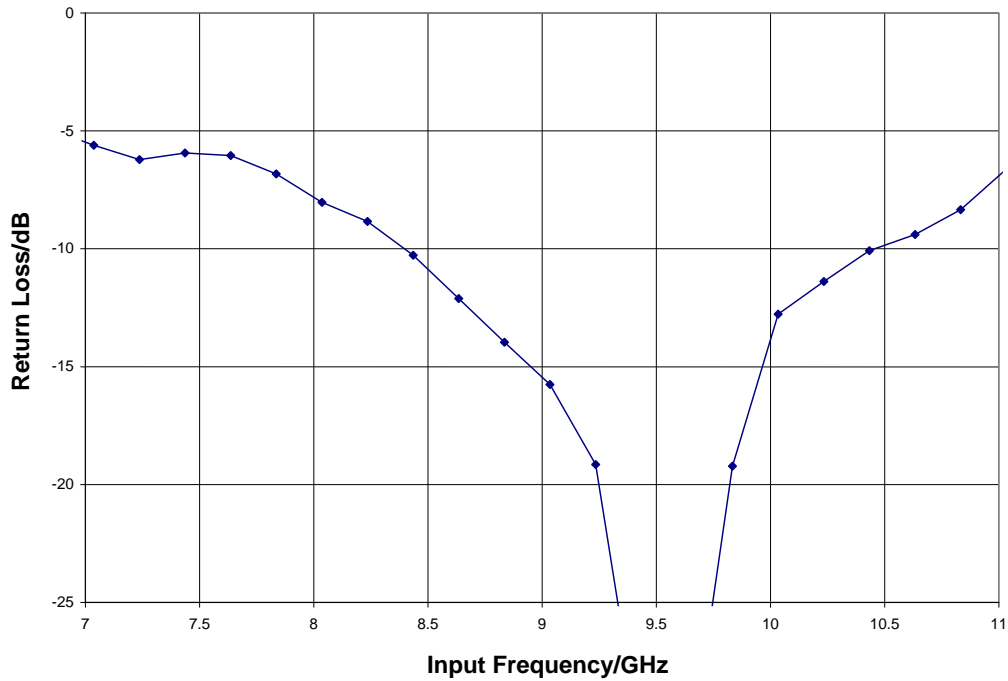

Output Return Loss @ +15 dBm Drive Level, F = 9 GHz Input, T_A = 25 °C

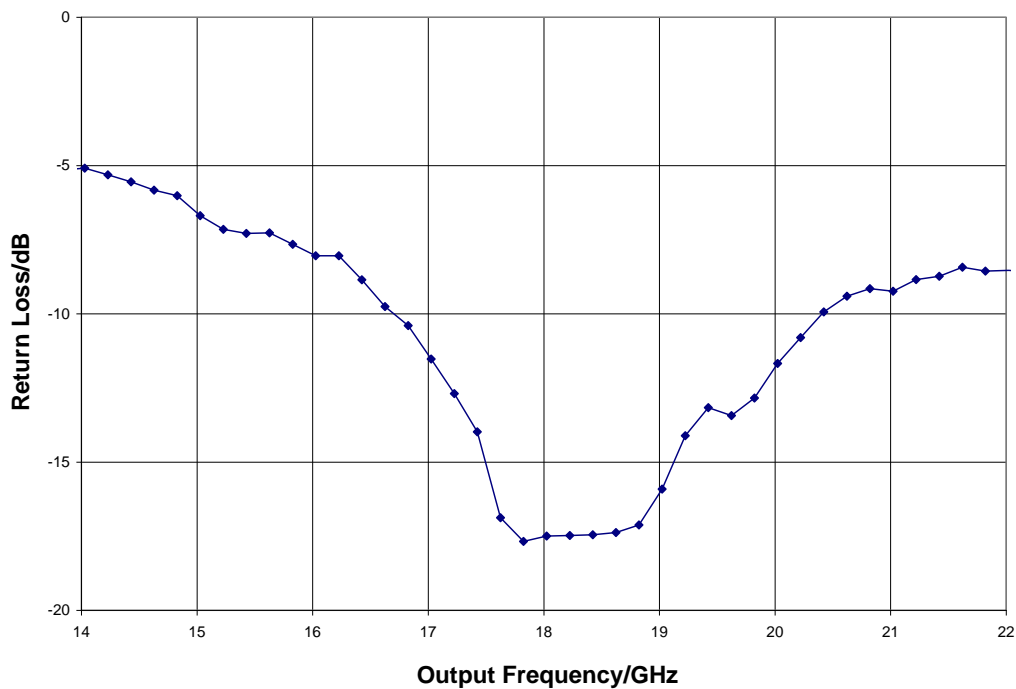

Mechanical Information

Package Information and Dimensions

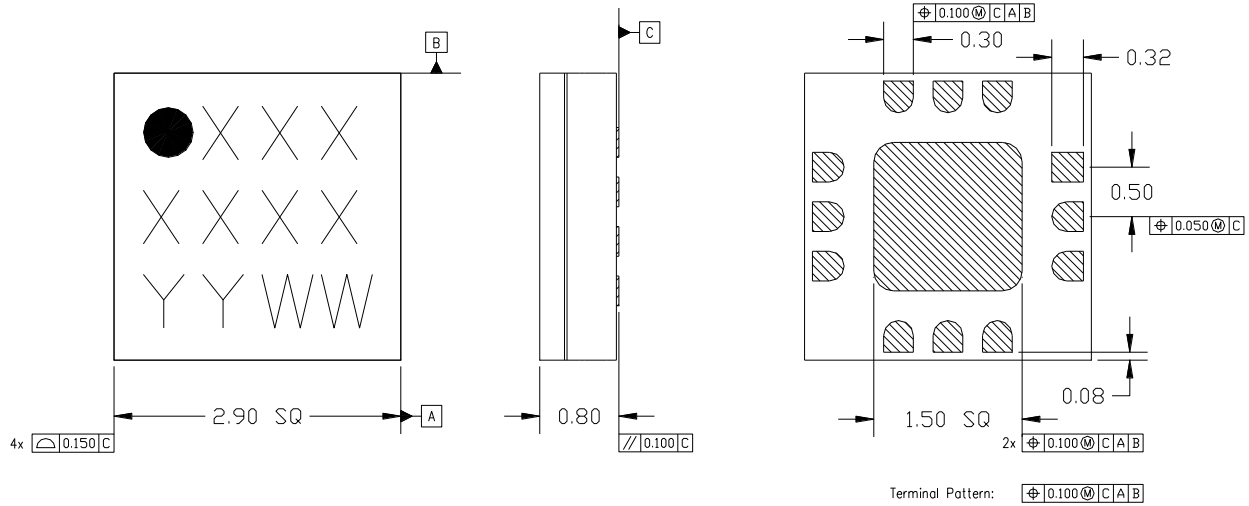

Notes:

1. All dimensions shown in mm.
2. Material: Black alumina
3. Lead finish:
 - 3.1. Ni: 8.89um max, 1.27um min
 - 3.2. Pd: 0.17um max, 0.07um min
 - 3.3. Au: 0.254um max, 0.03um min
4. Marking
 - 4.1. Line 1: Part number
 - 4.1.1. Example: CMD226C3 shall be marked as 226
 - 4.2. Line 2: Lot number
 - 4.3. Line 3: Date code - Last 2 digits of the year of manufacture followed by a 2 digit week code
5. Alternate pin #1 identifier is a single square pad
6. Alternate die paddle may have chamfered corners

Recommended PCB Land Pattern

Qorvo recommends that the user develop the land pattern that will provide the best design for proper solder reflow and device attach for their specific application. Please review Qorvo Application Note AN 105 for a recommended land pattern approach.

Recommended Solder Reflow Profile

Qorvo recommends screen printing with belt furnace reflow to ensure proper solder reflow and device attach. Please review Qorvo Application Note AN 102 for a recommended solder reflow profile.

Pin Description

Pin Diagram

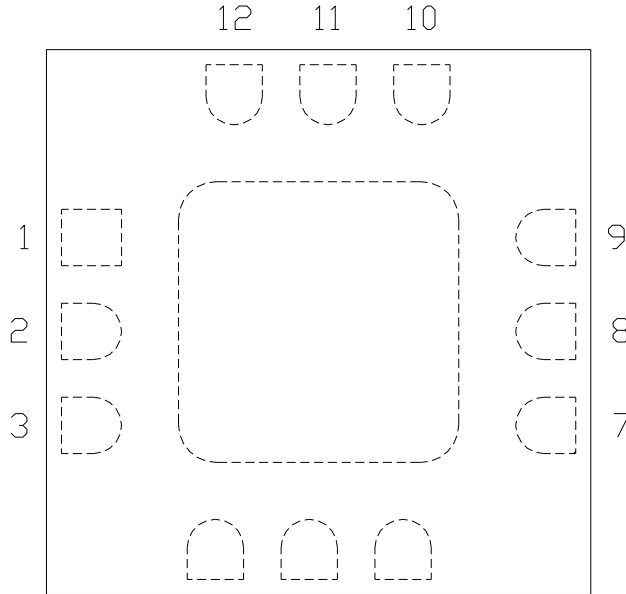

Functional Description

Pad	Function	Description	Schematic
1, 3, 7, 9 and die paddle	Ground	Connect to RF / DC ground	
2	RF in	Pin is DC coupled and 50 ohm matched	
4 - 6, 10 - 12	N/C	No connection required These pins may be connected to RF / DC ground	
8	RF out	Pin is DC coupled and 50 ohm matched	

Applications Information

Evaluation Board

The circuit board shown has been developed for optimized assembly at Qorvo. A sufficient number of via holes should be used to connect the top and bottom ground planes. As surface mount processes vary, careful process development is recommended.

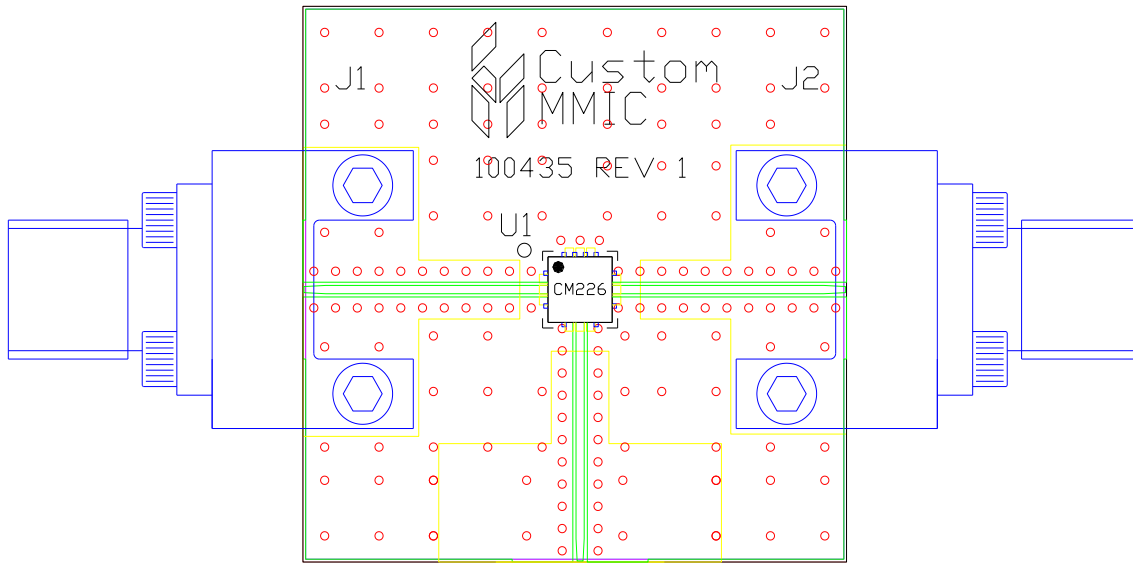

Bill of Material

Designator	Value	Description
J1 - J2		SMA End Launch Connector
U1		CMD226C3 Frequency Doubler
PCB		100435 Evaluation PCB

Handling Precautions

Parameter	Rating	Standard
ESD – Human Body Model (HBM)	Class 1A	ESDA / JEDEC JS-001-2012
MSL – Moisture Sensitivity Level	Level 1	JEDEC standard IPC/JEDEC J-STD-020



Caution!
 ESD-Sensitive Device

RoHS Compliance

This part is compliant with 2011/65/EU RoHS directive (Restrictions on the Use of Certain Hazardous Substances in Electrical and Electronic Equipment) as amended by Directive 2015/863/EU.

This product also has the following attributes:

- Lead Free
- Antimony Free
- TBBP-A (C₁₅H₁₂Br₄O₂) Free
- SVHC Free
- Halogen Free
- PFOS Free

Contact Information

For the latest specifications, additional product information, worldwide sales and distribution locations:

Web: www.qorvo.com

Tel: 1-844-890-8163

Email: customer.support@qorvo.com

Important Notice

The information contained in this Data Sheet and any associated documents (“Data Sheet Information”) is believed to be reliable; however, Qorvo makes no warranties regarding the Data Sheet Information and assumes no responsibility or liability whatsoever for the use of said information. All Data Sheet Information is subject to change without notice. Customers should obtain and verify the latest relevant Data Sheet Information before placing orders for Qorvo® products. Data Sheet Information or the use thereof does not grant, explicitly, implicitly or otherwise any rights or licenses to any third party with respect to patents or any other intellectual property whether with regard to such Data Sheet Information itself or anything described by such information.

DATA SHEET INFORMATION DOES NOT CONSTITUTE A WARRANTY WITH RESPECT TO THE PRODUCTS DESCRIBED HEREIN, AND QORVO HEREBY DISCLAIMS ANY AND ALL WARRANTIES WITH RESPECT TO SUCH PRODUCTS WHETHER EXPRESS OR IMPLIED BY LAW, COURSE OF DEALING, COURSE OF PERFORMANCE, USAGE OF TRADE OR OTHERWISE, INCLUDING THE IMPLIED WARRANTIES OF MERCHANTABILITY AND FITNESS FOR A PARTICULAR PURPOSE. Without limiting the generality of the foregoing, Qorvo® products are not warranted or authorized for use as critical components in medical, life-saving, or life-sustaining applications, or other applications where a failure would reasonably be expected to cause severe personal injury or death. Applications described in the Data Sheet Information are for illustrative purposes only. Customers are responsible for validating that a particular product described in the Data Sheet Information is suitable for use in a particular application.

© 2022 Qorvo US, Inc. All rights reserved. This document is subject to copyright laws in various jurisdictions worldwide and may not be reproduced or distributed, in whole or in part, without the express written consent of Qorvo US, Inc. | QORVO® is a registered trademark of Qorvo US, Inc.