

Features

- ▶ Wide bandwidth
- ▶ Low phase noise
- ▶ Low current consumption
- ▶ Small die size

Description

The CMD247 is a wideband GaAs MMIC low phase noise amplifier ideally suited for military, space and communications systems. At 35 GHz the device delivers 13 dB of gain, a saturated output power of +15 dBm and a noise figure of 5 dB. Also the amplifier provides low phase noise of less than -160 dBc/Hz at 10 kHz offset. The CMD247 is a 50 ohm matched design which eliminates the need for external DC blocks and RF port matching. The CMD247 offers full passivation for increased reliability and moisture protection.

Functional Block Diagram

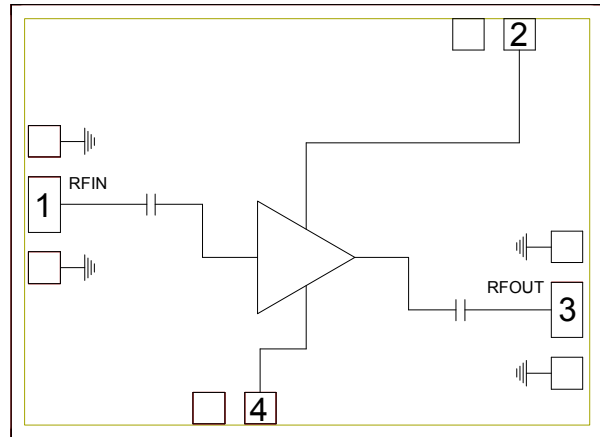

Electrical Performance - $V_{dd} = 3.0\text{ V}$, $V_{gg} = 3.0\text{ V}$, $T_A = 25\text{ }^\circ\text{C}$, $F=35\text{ GHz}$

Parameter	Min	Typ	Max	Units
Frequency Range	30 - 40			GHz
Gain		13		dB
Input Return Loss		11		dB
Output Return Loss		9		dB
Noise Figure		5		dB
Output P1dB		13.5		dBm
Saturated Output Power		15		dBm
Supply Current		28		mA

ver 1.0 0816



CMD247

30-40 GHz Low Phase Noise Amplifier

Specifications

Absolute Maximum Ratings

Parameter	Rating
Drain Voltage, V _{dd}	5.0 V
Gate Voltage, V _{gg}	5.0 V
RF Input Power	+12 dBm
Channel Temperature, T _{ch}	150 °C
Power Dissipation, P _{diss}	112 mW
Thermal Resistance	578 °C/W
Operating Temperature	-55 to 85 °C
Storage Temperature	-55 to 150 °C

Operation of this device outside the maximum ratings may cause permanent damage.

Recommended Operating Conditions

Parameter	Min	Typ	Max	Units
V _{dd}	2.0	3.0	4.0	V
I _{dd}		28		mA
V _{gg}	0	3.0	4.0	V

Electrical performance is measured at specific test conditions. Electrical specifications are not guaranteed over all recommended operating conditions.

Electrical Specifications, V_{dd} = 3.0 V, V_{gg} = 3.0 V, T_A = 25 °C

Parameter	Min	Typ	Max	Min	Typ	Max	Units
Frequency Range	30 - 35			35 - 40			GHz
Gain	10	14	18	8	12	16	dB
Noise Figure		5.5			5		dB
Input Return Loss		12			9		dB
Output Return Loss		9			11		dB
Output P1dB	10	13		10.5	14		dBm
Saturated Output Power		15			15		dBm
Output IP3		21.5			20.5		dBm
Supply Current	19	28	37	19	28	37	mA

ver 1.0 0816

Typical Performance

Broadband Performance, $V_{dd} = 3.0\text{ V}$, $V_{gg} = 3.0\text{ V}$, $I_{dd} = 28\text{ mA}$, $T_A = 25\text{ }^\circ\text{C}$

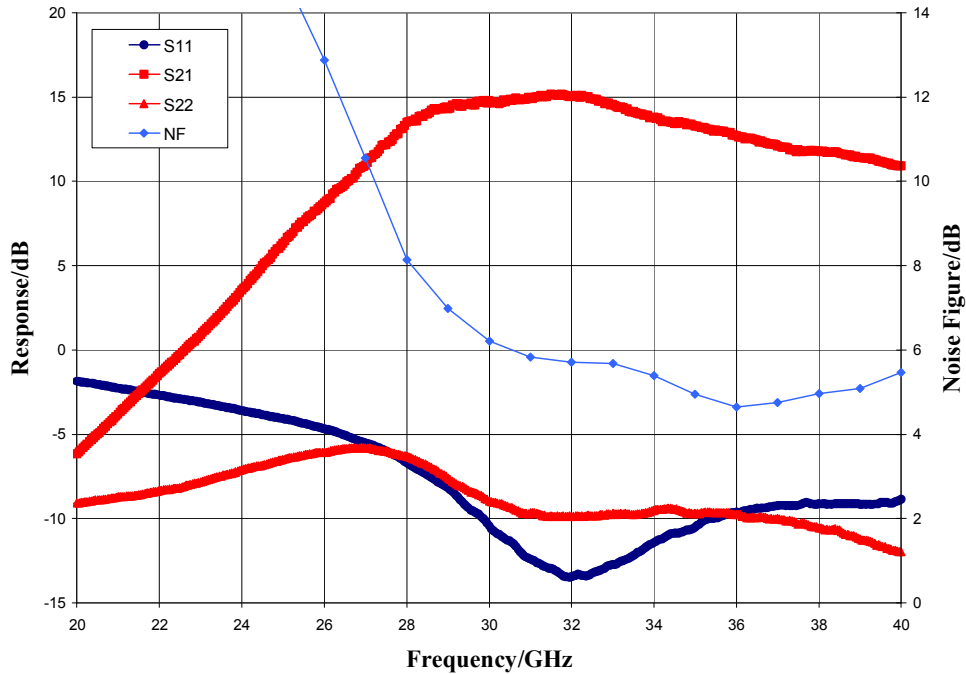

Narrow-band Performance, $V_{dd} = 3.0\text{ V}$, $V_{gg} = 3.0\text{ V}$, $I_{dd} = 28\text{ mA}$, $T_A = 25\text{ }^\circ\text{C}$

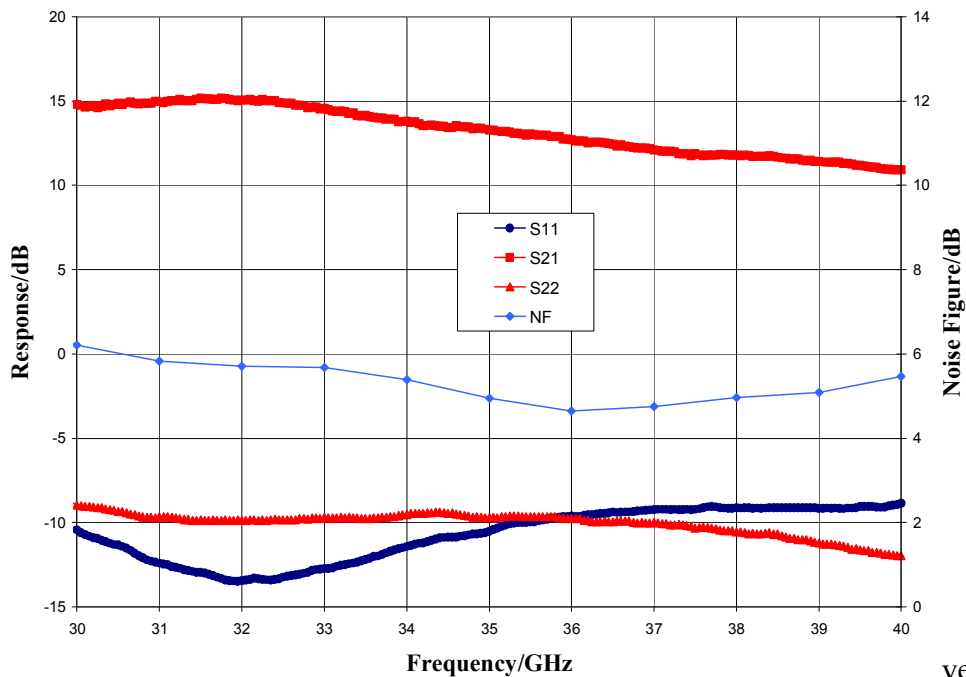

ver 1.0 0816

Typical Performance

Gain vs. Temperature, $V_{dd} = 3.0\text{ V}$, $V_{gg} = 3.0\text{ V}$

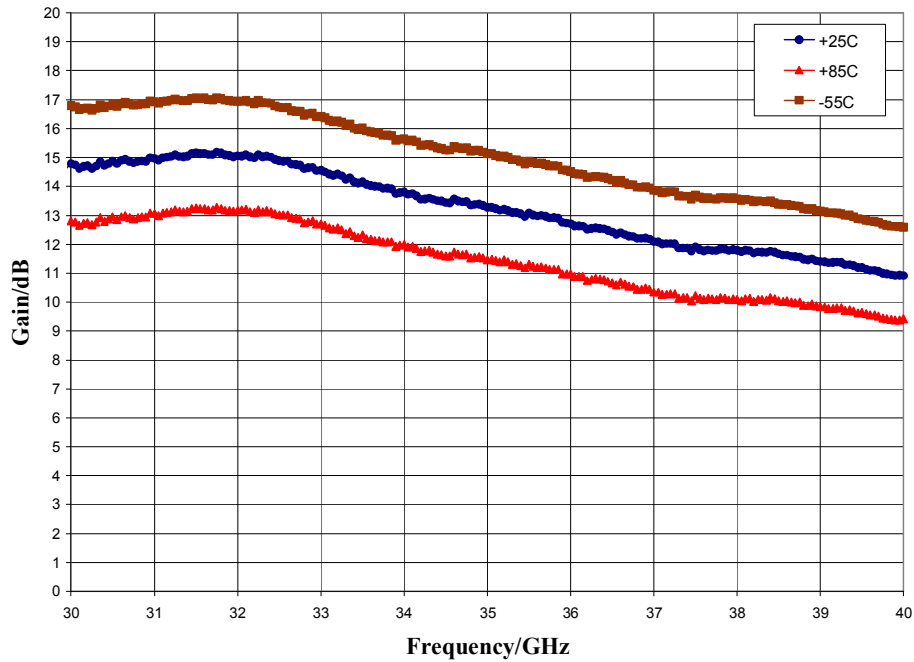

Noise Figure vs. Temperature, $V_{dd} = 3.0\text{ V}$, $V_{gg} = 3.0\text{ V}$

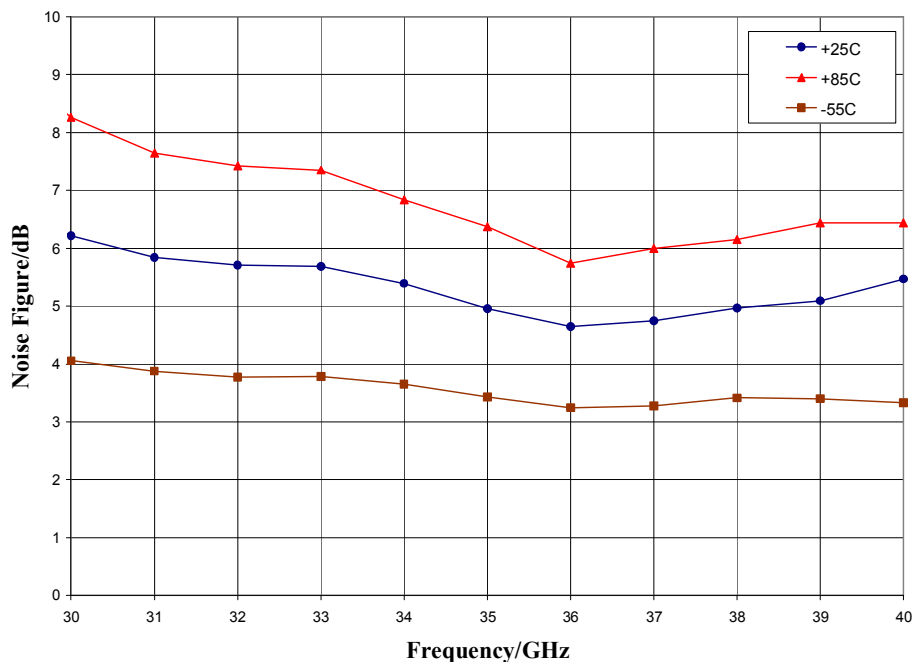

ver 1.0 0816

Typical Performance

Output Power, $V_{dd} = 3.0\text{ V}$, $V_{gg} = 3.0\text{ V}$, $T_A = 25\text{ }^\circ\text{C}$

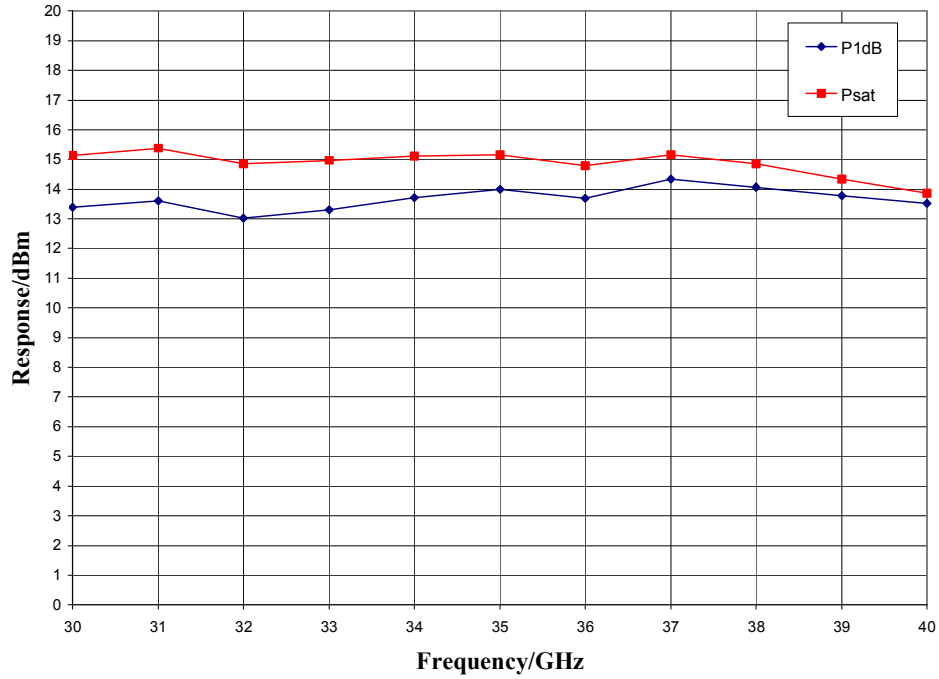

P1dB vs. Temperature, $V_{dd} = 3.0\text{ V}$, $V_{gg} = 3.0\text{ V}$

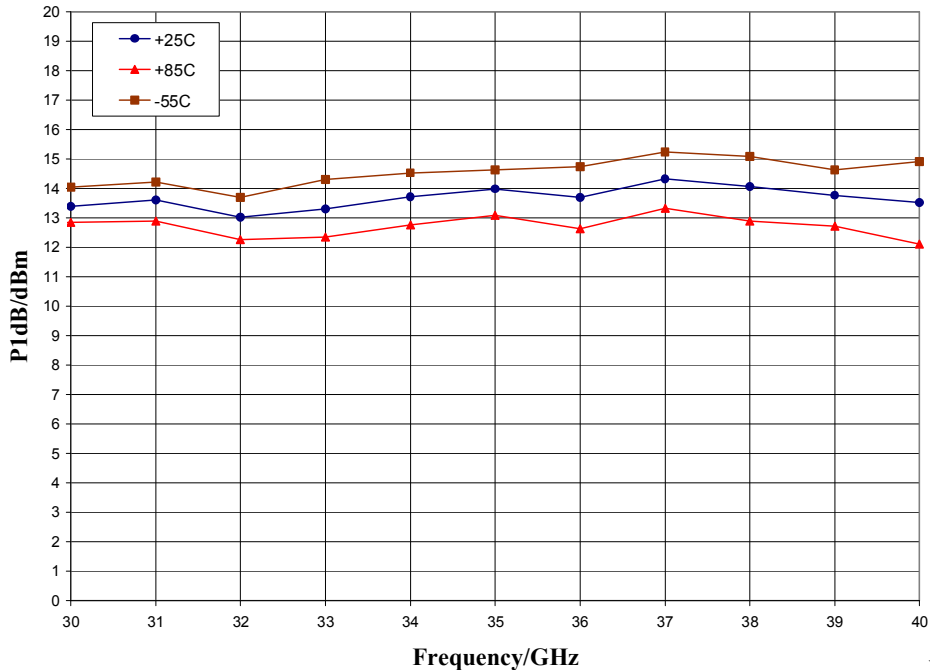

ver 1.0 0816

Typical Performance

Output IP3 vs. Temperature, $V_{dd} = 3.0\text{ V}$, $V_{gg} = 3.0\text{ V}$

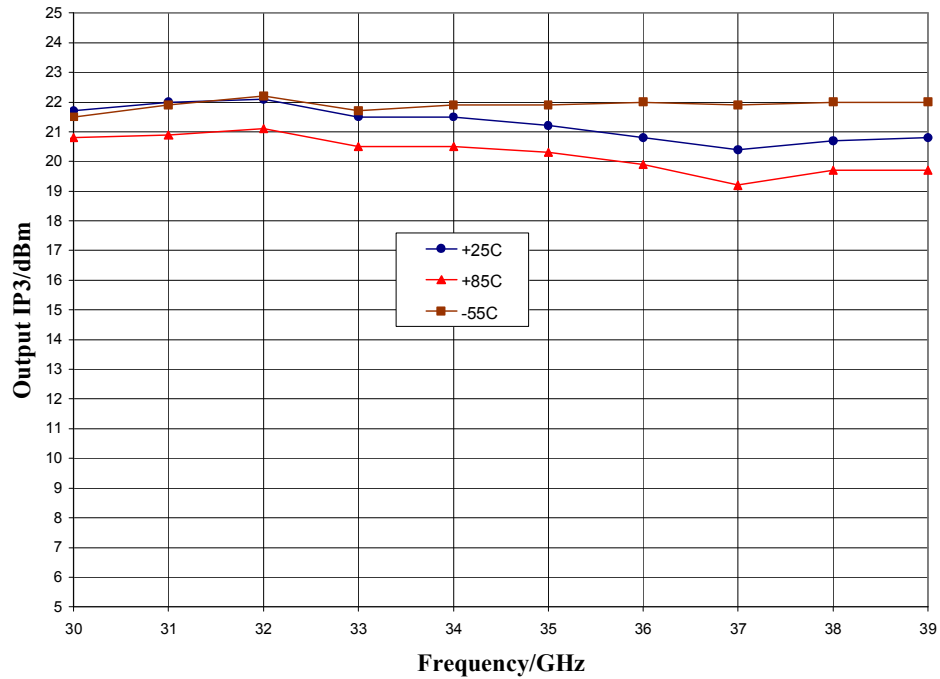

ver 1.0 0816

Mechanical Information

Die Outline (all dimensions in microns)

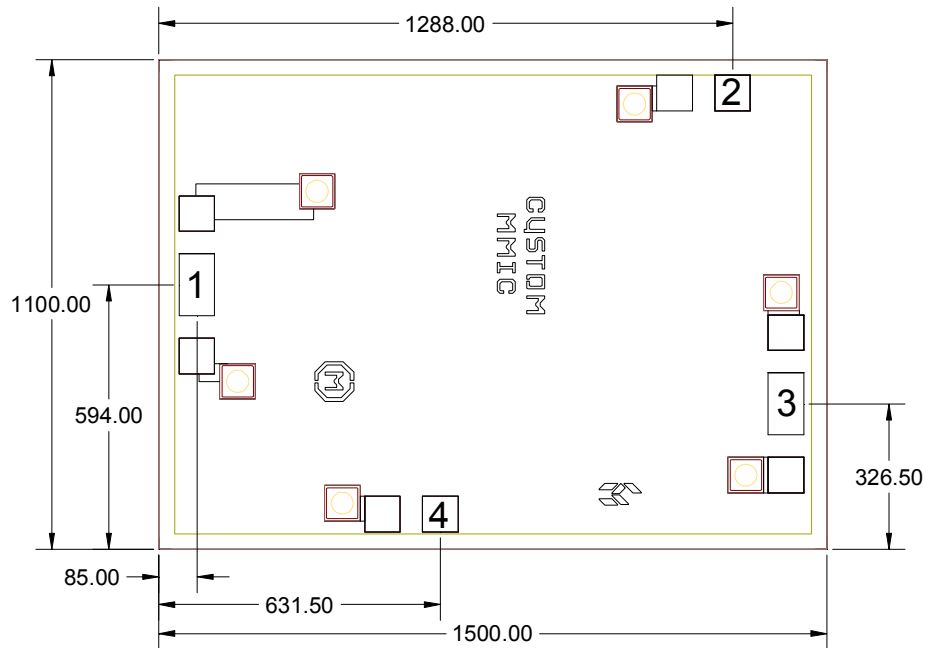

Notes:

1. No connection required for unlabeled pads
2. Backside is RF and DC ground
3. Backside and bond pad metal: Gold
4. Die is 100 microns thick
5. DC bond pads are 80 microns square
6. RF bond pads are 80 x 140 microns

Pad Description

Pad Diagram

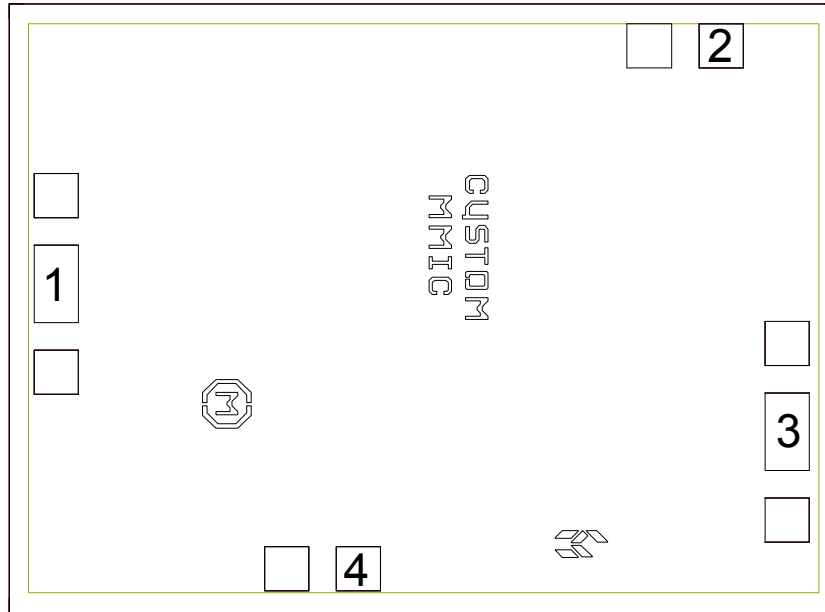

Functional Description

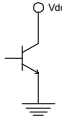
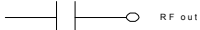
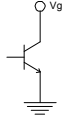
Pad	Function	Description	Schematic
1	RF in	DC blocked and 50 ohm matched	
2	Vdd	Power supply voltage Decoupling and bypass caps required	
3	RF out	DC blocked and 50 ohm matched	
4	Vgg	Power supply voltage Decoupling and bypass caps required	
Backside	Ground	Connect to RF / DC ground	

Applications Information

Assembly Guidelines

The backside of the CMD247 is RF ground. Die attach should be accomplished with electrically and thermally conductive epoxy only. Eutectic attach is not recommended. Standard assembly procedures should be followed for high frequency devices. The top surface of the semiconductor should be made planar to the adjacent RF transmission lines, and the RF decoupling capacitors placed in close proximity to the DC connections on chip.

RF connections should be made as short as possible to reduce the inductive effect of the bond wire. Use of a 0.8 mil thermosonic wedge bonding is highly recommended as the loop height will be minimized. The RF input and output require a double bond wire as shown.

The semiconductor is 100 um thick and should be handled by the sides of the die or with a custom collet. Do not make contact directly with the die surface as this will damage the monolithic circuitry. Handle with care.

Assembly Diagram

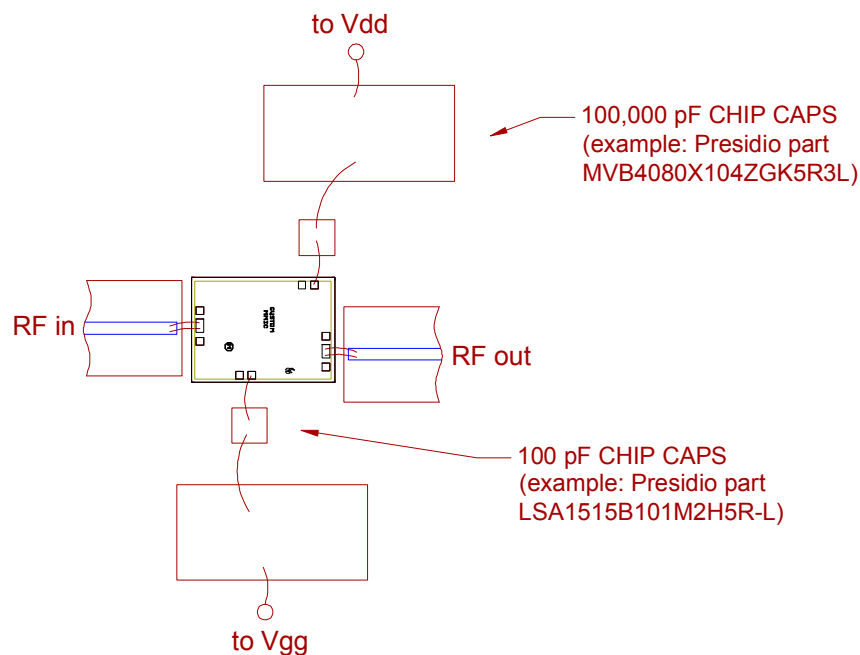

GaAs MMIC devices are susceptible to damage from Electrostatic Discharge. Proper precautions should be observed during handling, assembly and test.

ver 1.0 0816

Applications Information

Biasing and Operation

The CMD247 is biased with a positive drain supply and positive gate supply. Performance is optimized when the drain voltage is set to +3.0 V. The recommended gate voltage is +3.0 V.

Turn ON procedure:

1. Apply drain voltage V_{dd} and set to +3 V
2. Apply gate voltage V_{gg} and set to +3 V

Turn OFF procedure:

1. Turn off gate voltage V_{gg}
2. Turn off drain voltage V_{dd}

RF power can be applied at any time.