

Features

- ▶ Low conversion loss
- ▶ High isolation
- ▶ Wide IF bandwidth
- ▶ Passive double balanced topology
- ▶ Pb-free RoHs compliant 3x3 mm SMT package

Description

The CMD251C3 is a general purpose double balanced mixer in a leadless surface mount package that can be used for up- and downconverting applications between 4 and 8.5 GHz. The CMD251C3 has very high isolation to both the RF and IF ports due to the optimized balun structures, and can operate with an LO drive level as low as +15 dBm. The CMD251C3 can easily be configured as an image reject mixer or single sideband modulator with external hybrids and power splitters.

Functional Block Diagram

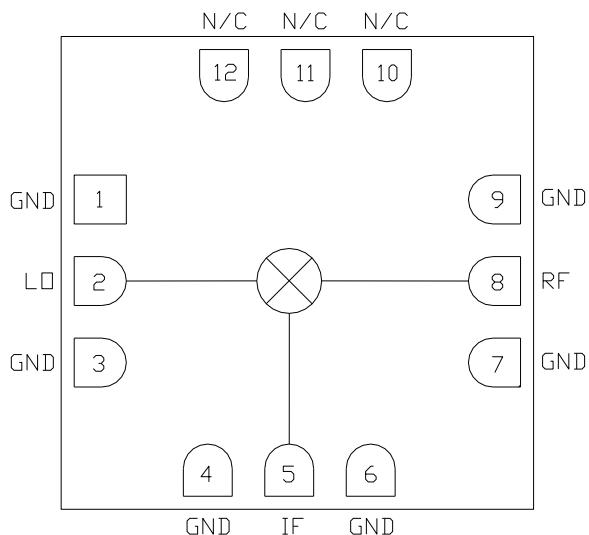

Electrical Performance – IF = 100 MHz, LO = +17 dBm, $T_A = 25^\circ\text{C}$, F = 6 GHz

Parameter	Min	Typ	Max	Units
Frequency Range, RF & LO	4 – 8.5			GHz
Frequency Range, IF	DC		2.2	GHz
Conversion Loss		7		dB
LO to RF Isolation		45		dB
LO to IF Isolation		36		dB
RF to IF Isolation		25		dB
Input IP3		21		dBm

Unless otherwise noted, all measurements performed as a downconverter, IF = 100 MHz

Specifications

Absolute Maximum Ratings

Parameter	Rating
RF / IF Input Power	+25 dBm
LO Drive	+25 dBm
Operating Temperature	-40 to 85 °C
Storage Temperature	-55 to 150 °C
Thermal resistance, Θ_{JC}	280.4 °C/ W

Operation of this device outside the maximum ratings may cause permanent damage.

Electrical Specifications – IF = 100 MHz, LO = +17 dBm, T_A = 25 °C

Parameter	Min	Typ	Max	Min	Typ	Max	Units
Frequency Range, RF & LO	4 – 7			7 – 8.5			GHz
Frequency Range, IF	DC		2.2	DC		2.2	GHz
Conversion Loss		7	8.5		8.5	10	dB
Noise Figure (SSB)		7	8.5		8.5	10	dB
LO to RF Isolation	40	45		40	45		dB
LO to IF Isolation	30	40		42	50		dB
RF to IF Isolation	15	25		30	35		dB
Input P1dB		16			17		dBm
Input IP3		22			25		dBm

Unless otherwise noted, all measurements performed as a downconverter, IF = 100 MHz

ver 1.0 0717

Typical Performance

Conversion Gain vs. Temperature, LO = +17 dBm, IF = 100 MHz USB

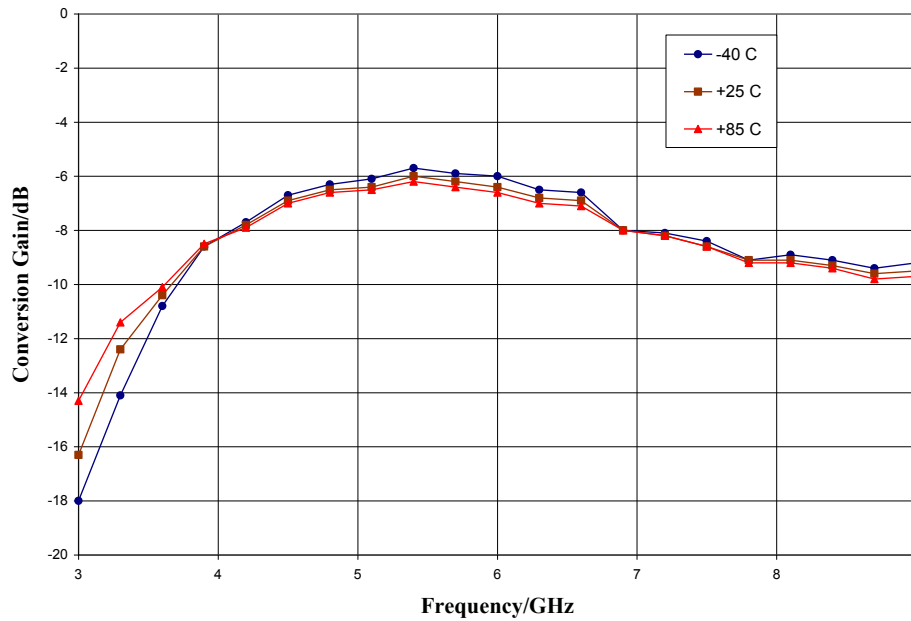

Isolations, LO = +17 dBm

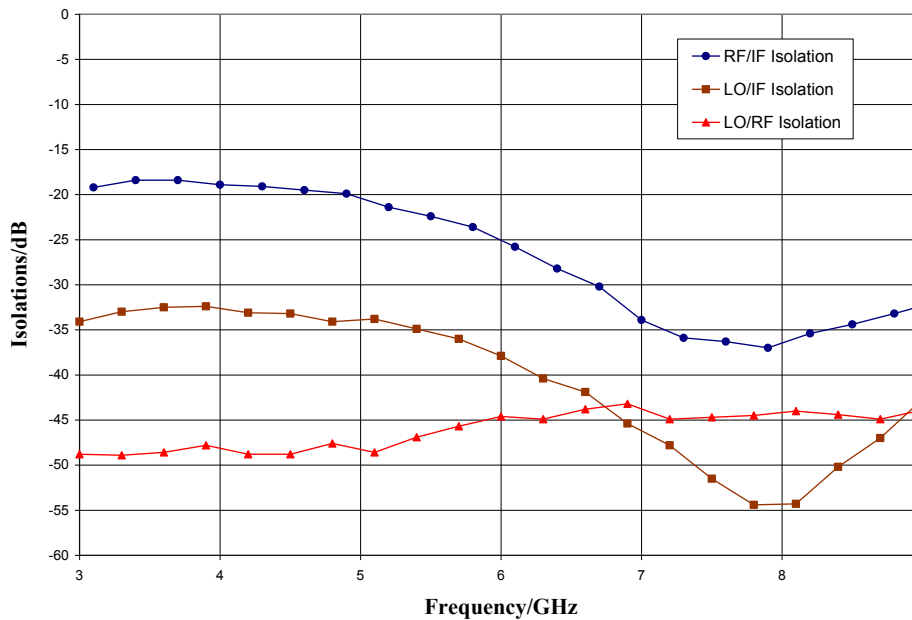

ver 1.0 0717

Typical Performance

Conversion Gain vs. LO Drive, IF = 100 MHz USB

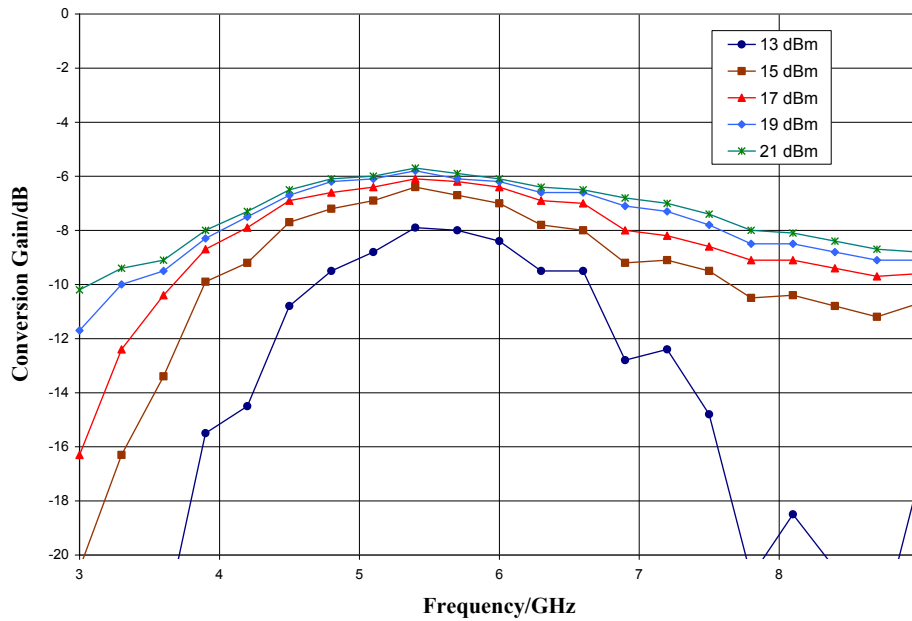

Return Loss, LO = +17 dBm

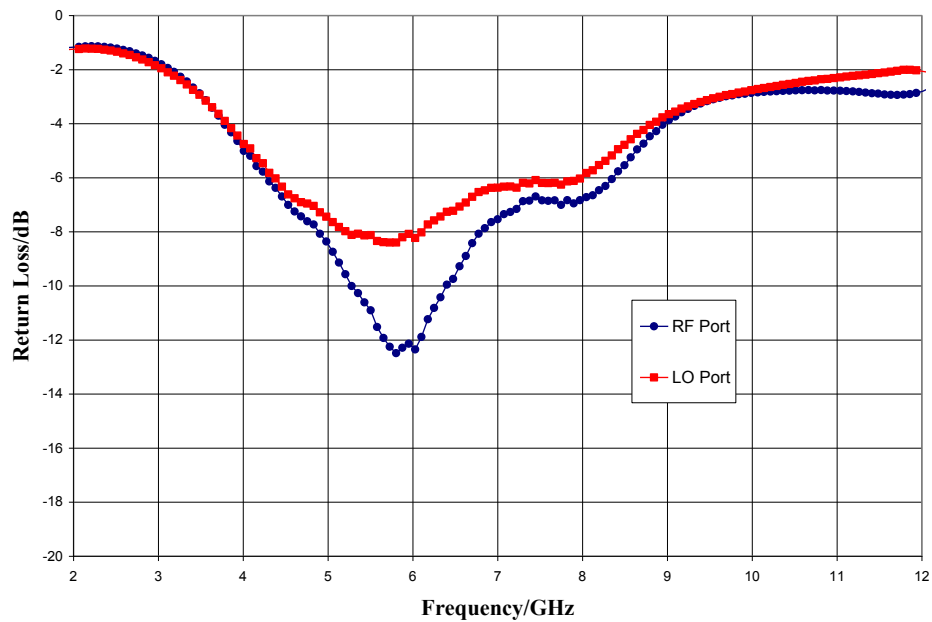

ver 1.0 0717

Typical Performance

IF Bandwidth, LO = +17 dBm

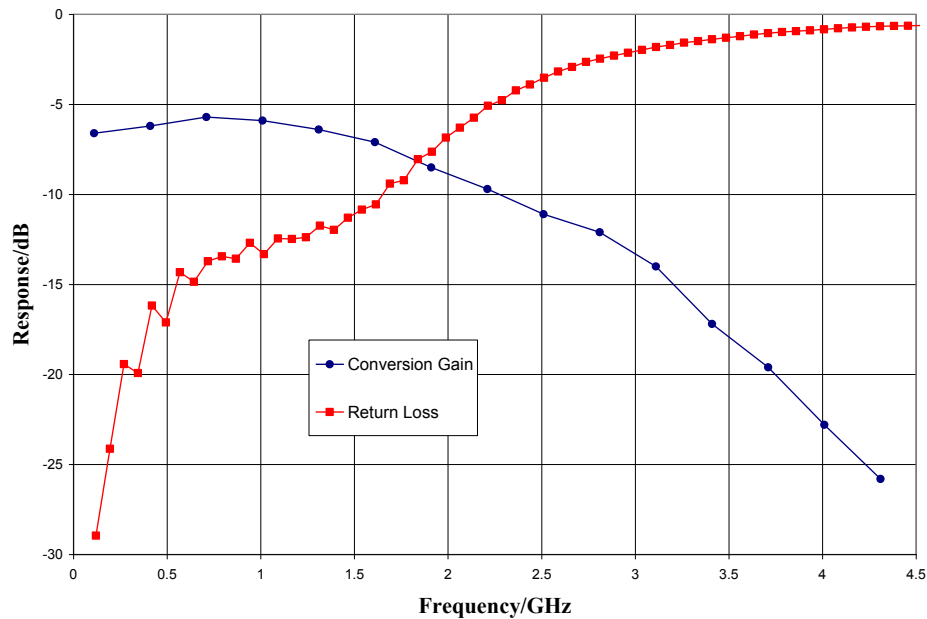

Upconverter Performance, Conversion Gain vs. LO Drive, IF input = 100 MHz

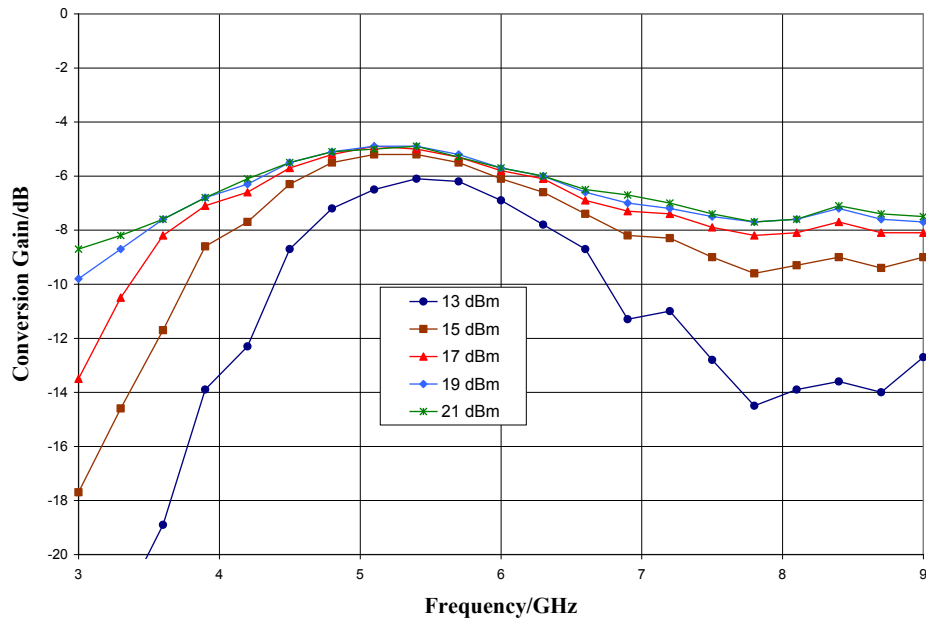

ver 1.0 0717

Typical Performance

Input IP3 vs. Temperature, LO = +17 dBm, IF = 100 MHz

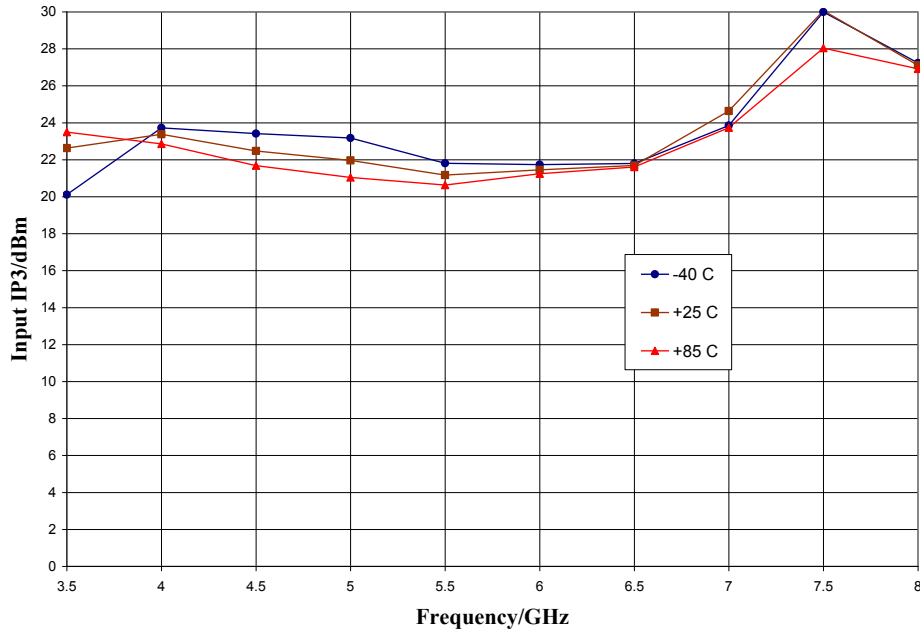

Input IP3 vs. LO Drive, IF = 100 MHz

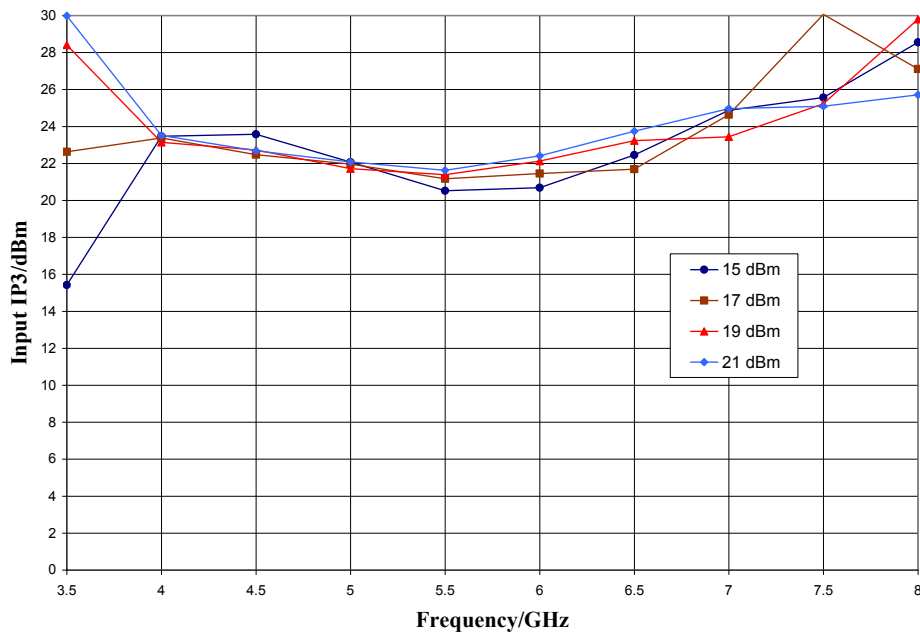

ver 1.0 0717

Typical Performance

Upconverter Performance, Input IP3 vs. LO Drive, IF = 100 MHz

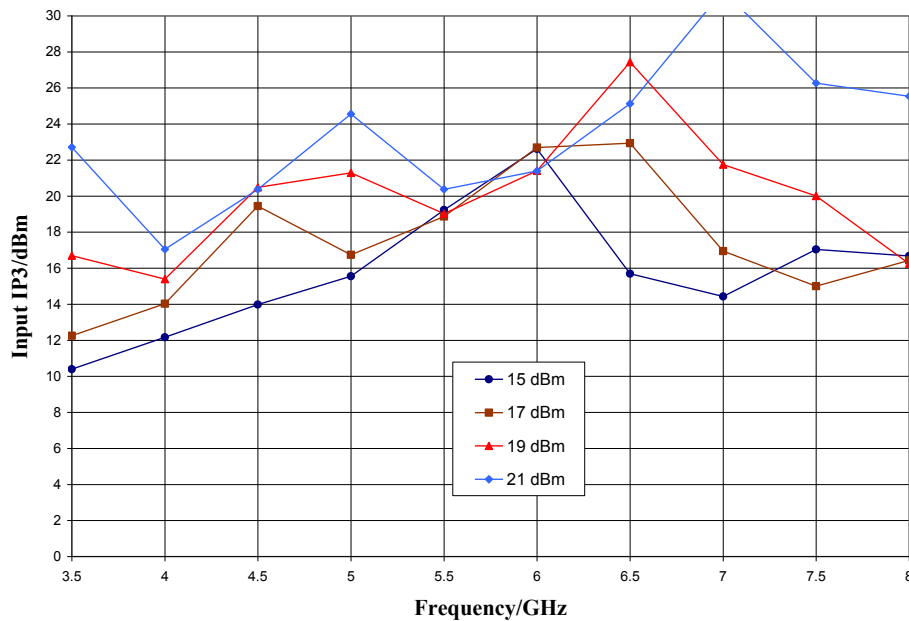

Input P1dB vs. Temperature, LO = +17 dBm, IF = 100 MHz USB

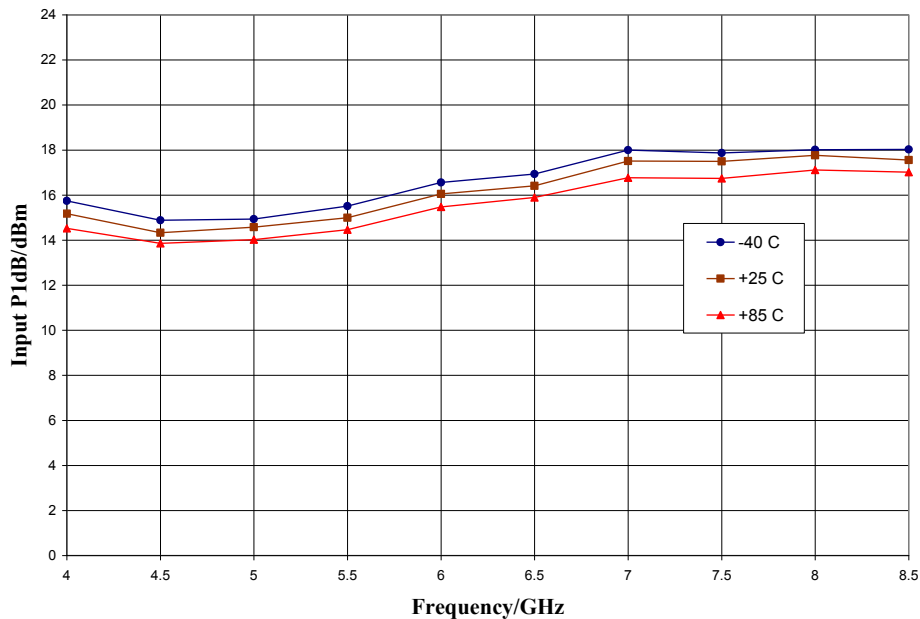

ver 1.0 0717

Typical Performance

MxN Spurious Outputs

mRF	nLO				
	0	1	2	3	4
0	xx	7	9	22	35
1	21	0	35	36	39
2	67	> 80	70	71	68
3	> 80	> 80	> 80	> 80	> 80
4	> 80	> 80	> 80	> 80	> 80

RF = 6.1 GHz @ -10 dBm

LO = 6.0 GHz @ +17 dBm

All values in dBc below the IF output power level (1RF - 1LO)

Mechanical Information

Package Information and Dimensions

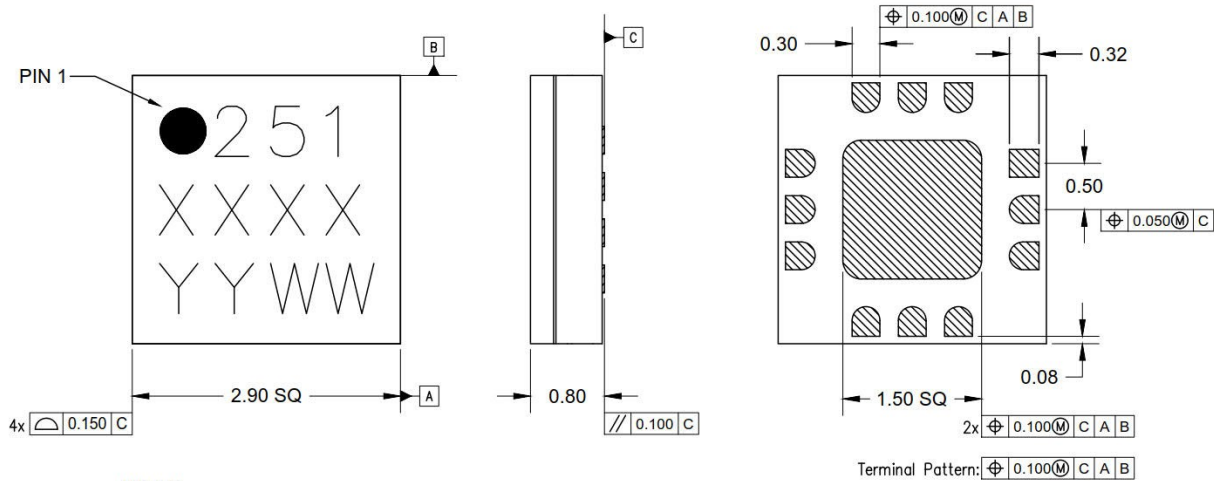

NOTES:

1. ALL DIMENSIONS SHOWN IN mm.
2. MATERIAL: BLACK ALUMINA
3. LEAD FINISH:
 - 3.1. Ni: 8.89um MAX, 1.27um MIN
 - 3.2. Pd: 0.17um MAX, 0.07um MIN
 - 3.3. Au: 0.254um MAX, 0.03um MIN
4. MARKING: ALL MARKING SHALL BE PERMANENT AND LEGIBLE
5. ALTERNATE PIN #1 IDENTIFIER IS A SINGLE SQUARE PAD

Recommended PCB Land Pattern

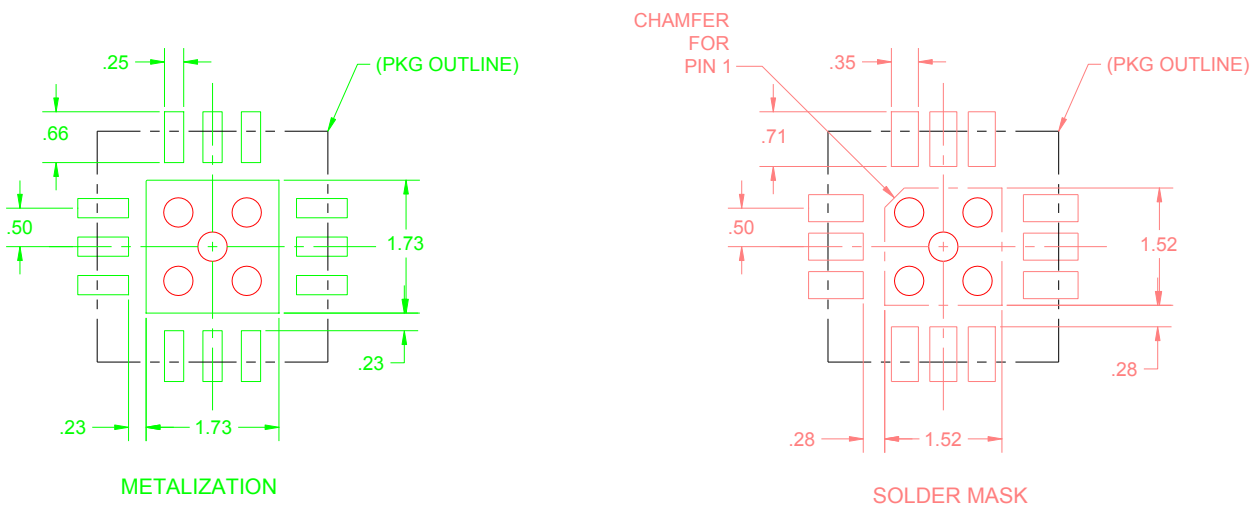

ver 1.0 0717

Pin Description

Pin Diagram

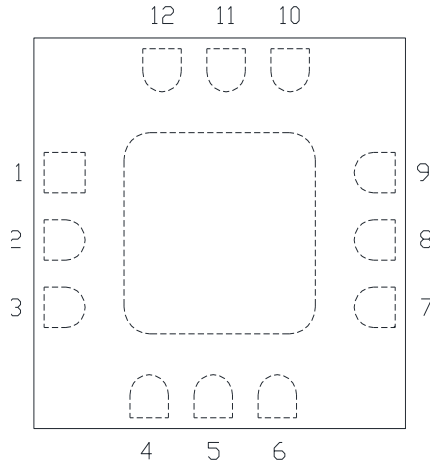

Functional Description

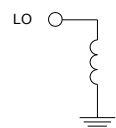
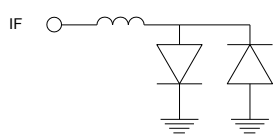
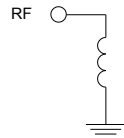
Pin	Function	Description	Schematic
1,3,4,6,7,9 and die paddle	Ground	Connect to RF / DC ground.	
2	LO	This pin is DC coupled and matched to 50 ohms.	
5	IF	This pin is DC coupled. For applications not requiring operation to DC, this port should be DC blocked externally using a series capacitor whose value has been chosen to pass the necessary IF frequency range. For operation to DC, this pin must not source or sink more than 16 mA of current or part non-function or part failure may result.	
8	RF	This pin is DC coupled and matched to 50 ohms.	
10-12	N/C	No connection required. These pins may be connected to RF/DC ground	

ver 1.0 0717

Applications Information

Evaluation Board

The circuit board shown has been developed for optimized assembly at Custom MMIC. A sufficient number of via holes should be used to connect the top and bottom ground planes. As surface mount processes vary, careful process development is recommended.

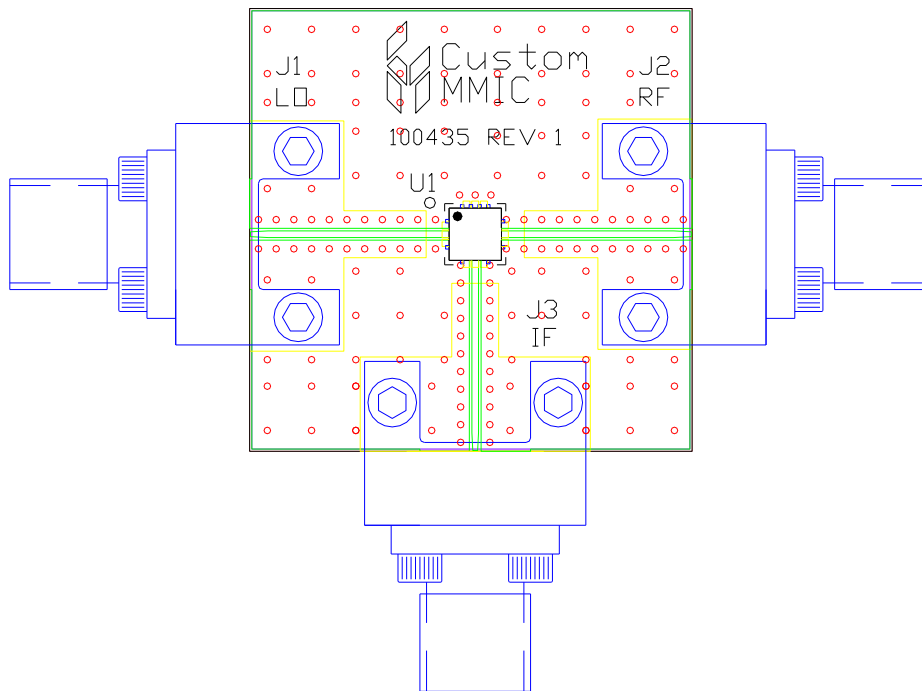
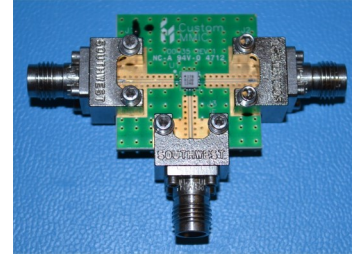

Bill of Material

Designator	Value	Description
J1 - J3		SMA End Launch Connector
U1		CMD251C3 Fundamental Mixer
PCB		100435 Evaluation PCB

GaAs MMIC devices are susceptible to damage from Electrostatic Discharge. Proper precautions should be observed during handling, assembly and test.

Please note, all information contained in this data sheet is subject to change without notice.

ver 1.0 0717