

Product Overview

The CMD252C4 is a compact I/Q mixer in a leadless surface mount package that can be used as either an image reject mixer or a single sideband upconverter. The CMD252C4 utilizes two double balanced mixer cells and a 90 degree hybrid. An external IF hybrid is needed to complete the image rejection. The CMD252C4 is a much smaller alternative to higher cost hybrid image reject mixers and single sideband upconverter assemblies.

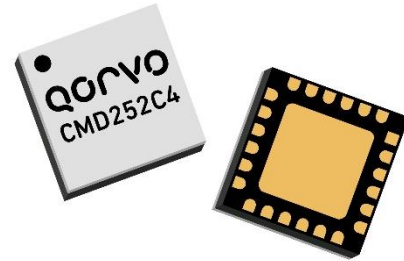

Functional Block Diagram

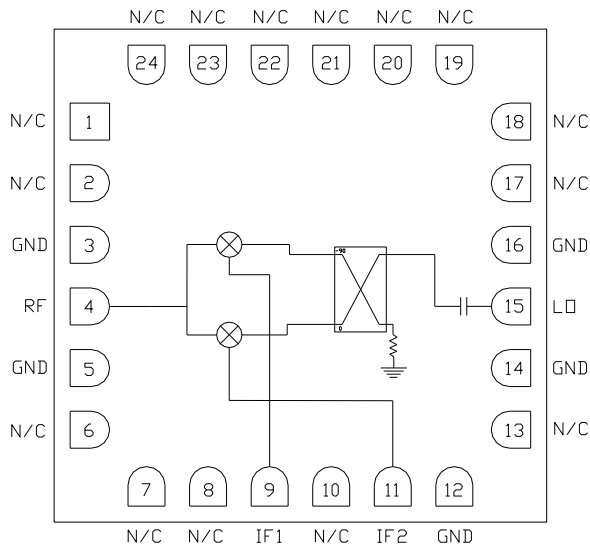

Key Features

- Low Conversion Loss
- High Isolation
- Image Rejection: 30 dB
- Wide IF Bandwidth
- Pb-Free RoHS Compliant 4x4 mm SMT Package

Ordering Information

Part No.	Description
CMD252C4	4-8 GHz I/Q Mixer, 100 Piece 7" Reel
CMD252C4-EVB	Evaluation Board

Electrical Performance (IF = 100 MHz, LO = +20 dBm, T_A = 25 °C, F = 6 GHz)

Parameter	Min	Typ	Max	Units
Frequency Range, RF & LO		4 - 8		GHz
Frequency Range, IF	DC		2.4	GHz
Conversion Loss (as IRM)		6.5		dB
Image Rejection		30		dB
LO to RF Isolation		52		dB
LO to IF Isolation		27		dB
Input IP3		25		dBm

Unless otherwise noted, all measurements performed as a downconverter, IF = 100 MHz

Absolute Maximum Ratings

Parameter	Rating
RF / IF Input Power	+25 dBm
LO Drive	+25 dBm
Operating Temperature	-40 to 85 °C
Storage Temperature	-55 to 150 °C
Thermal Resistance, θ_{JC}	70.5 °C / W
Power Dissipation, P_{diss}	921 mW

Exceeding any one or combination of the maximum ratings may cause permanent damage to the device.

Electrical Specifications (IF = 100 MHz, LO = +20 dBm, $T_A = 25\text{ °C}$)

Parameter	Min	Typ	Max	Min	Typ	Max	Units
Frequency Range, RF & LO		4 - 7			7 - 8		GHz
Frequency Range, IF	DC		2.4	DC		2.4	GHz
Conversion Loss (as IRM)		7	9		8.5	10	dB
Image Rejection	20	25		15	18		dB
LO to RF Isolation	40	50		50	55		dB
LO to IF Isolation	16	25		22	30		dB
Input P1dB		15			17		dBm
Input IP3		25			26		dBm

Unless otherwise noted, all measurements performed as a downconverter, IF = 100 MHz

Typical Performance

Data Taken As IRM With External IF Hybrid

Conversion Gain vs. Temperature, LO = +20 dBm, IF = 100 MHz USB

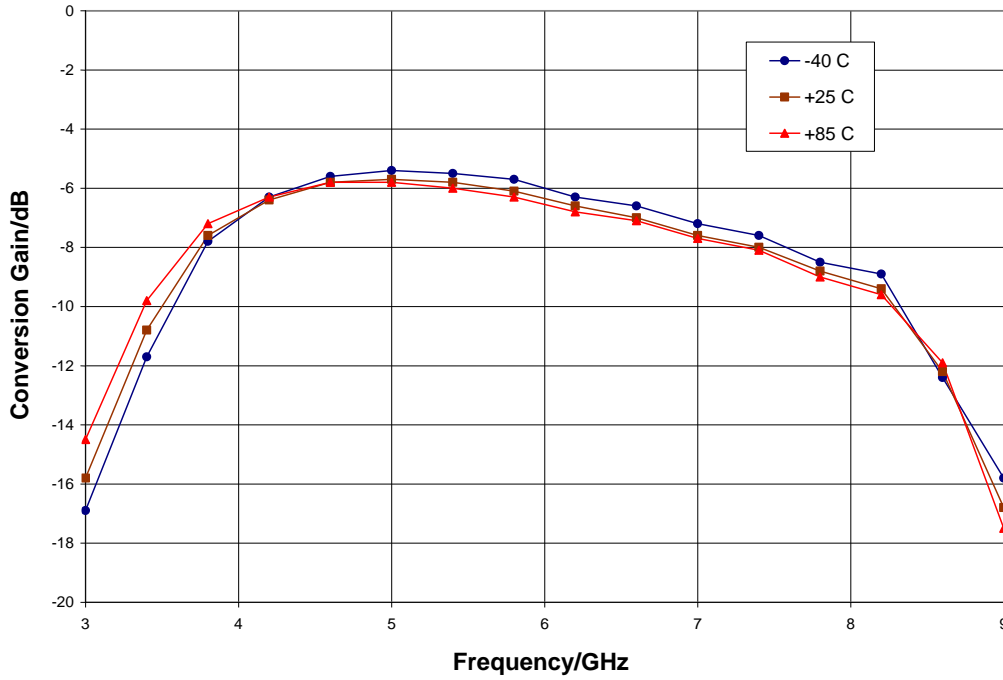

Conversion Gain vs. LO Drive, IF = 100 MHz USB

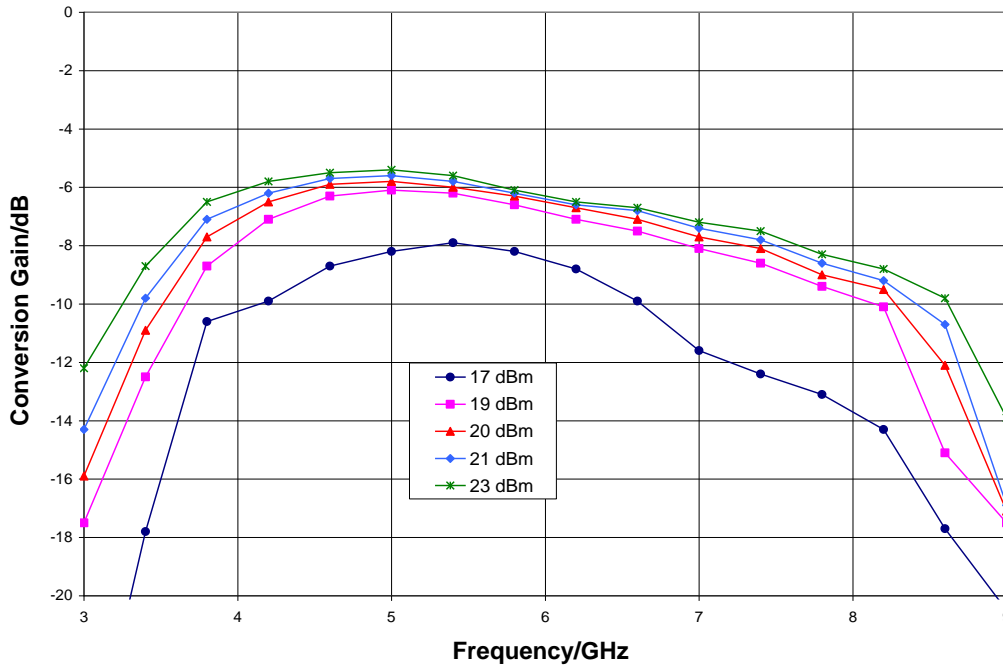

Typical Performance

Data Taken As IRM With External IF Hybrid

Image Rejection, LO = +20 dBm, IF = 100 MHz USB

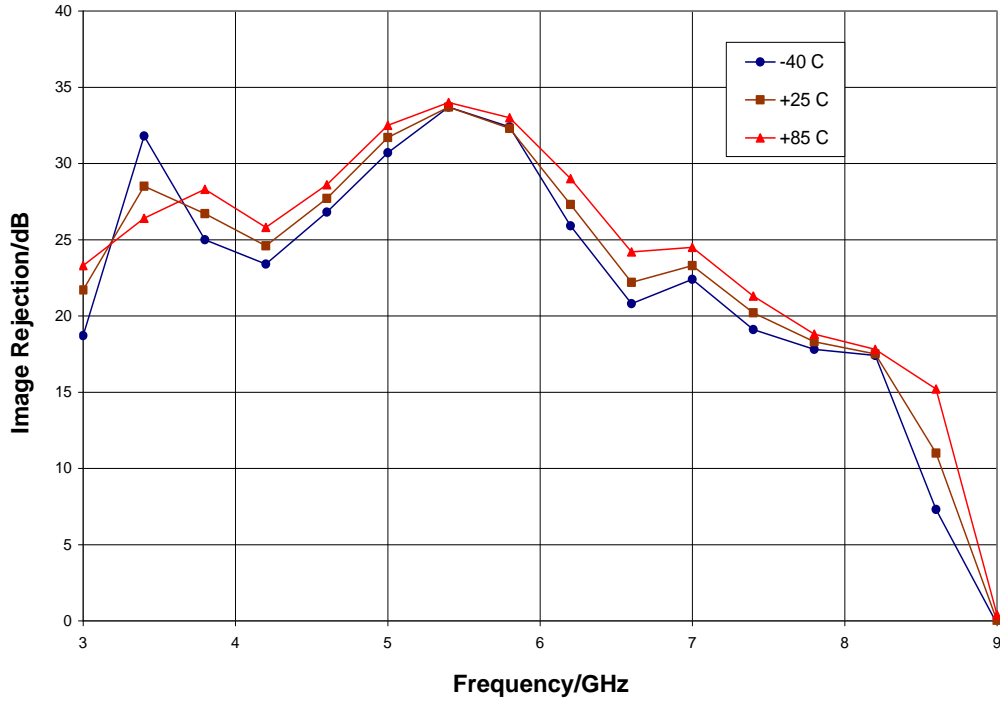

Return Loss, LO = +20 dBm

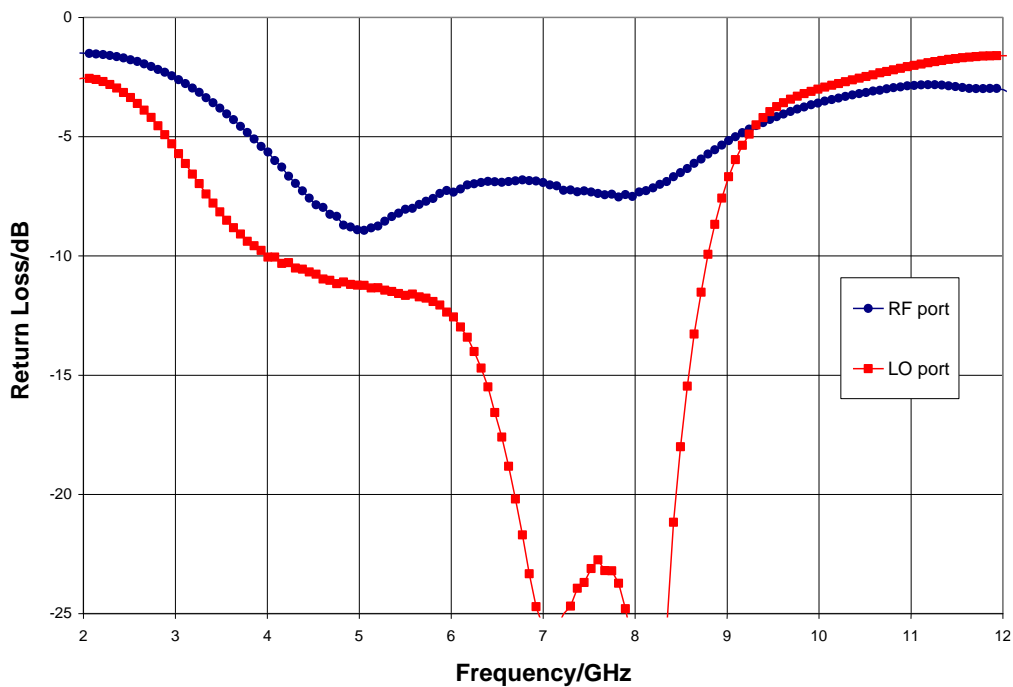

Typical Performance

Data Taken As IRM With External IF Hybrid

Input P1dB vs. Temperature, LO = +20 dBm, IF = 100 MHz USB

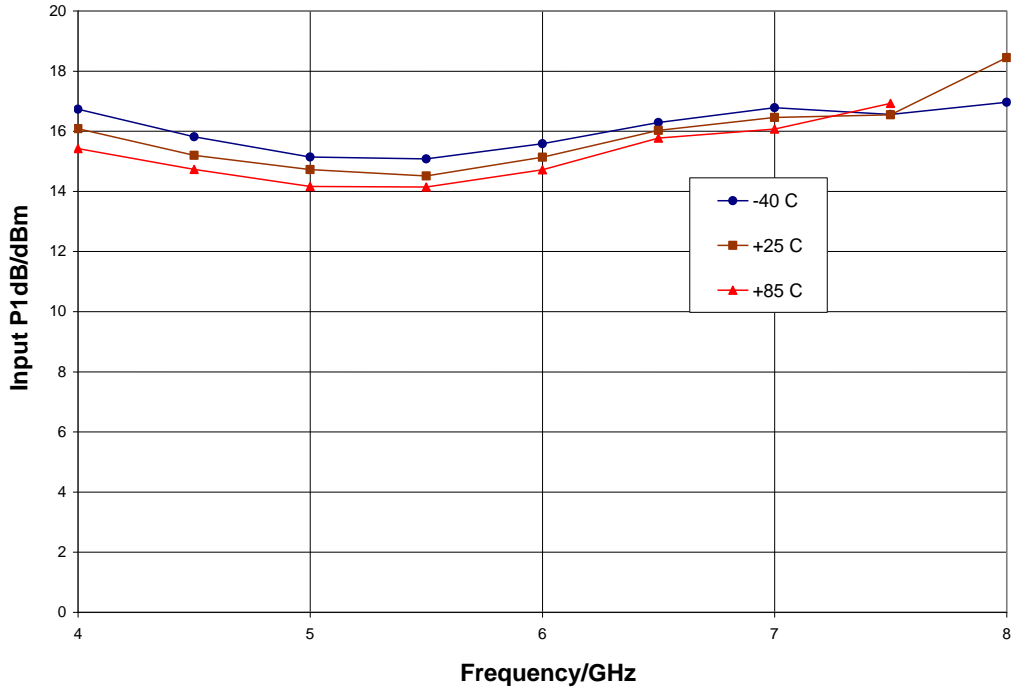

Input IP3 vs. Temperature, LO = +20 dBm, IF = 100 MHz USB

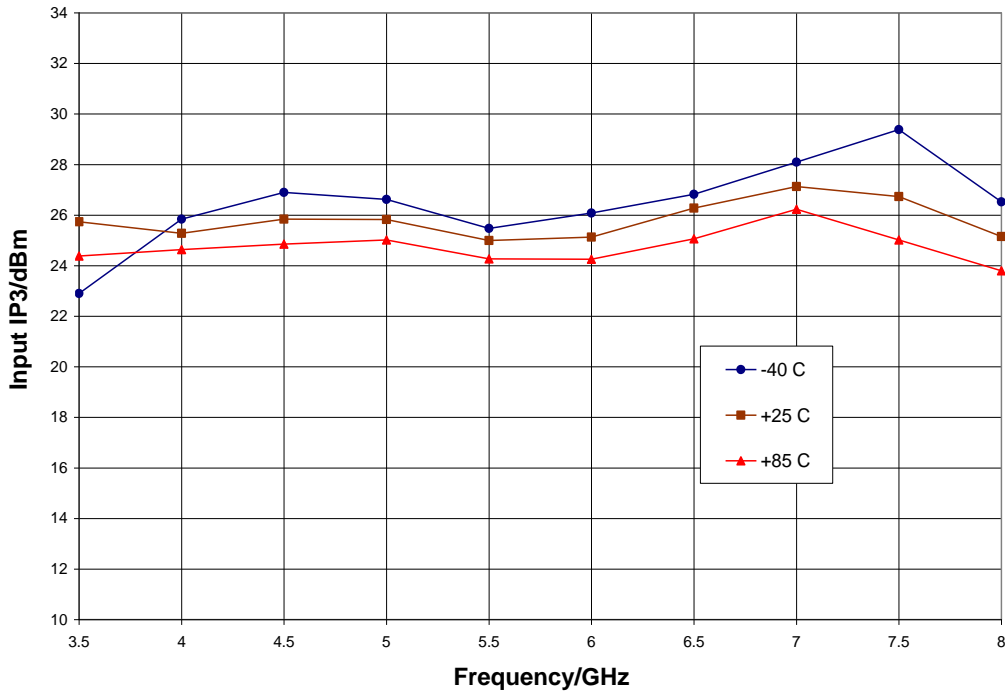

Typical Performance

Data Taken As IRM With External IF Hybrid

Input IP3 vs. LO Drive, IF = 100 MHz USB

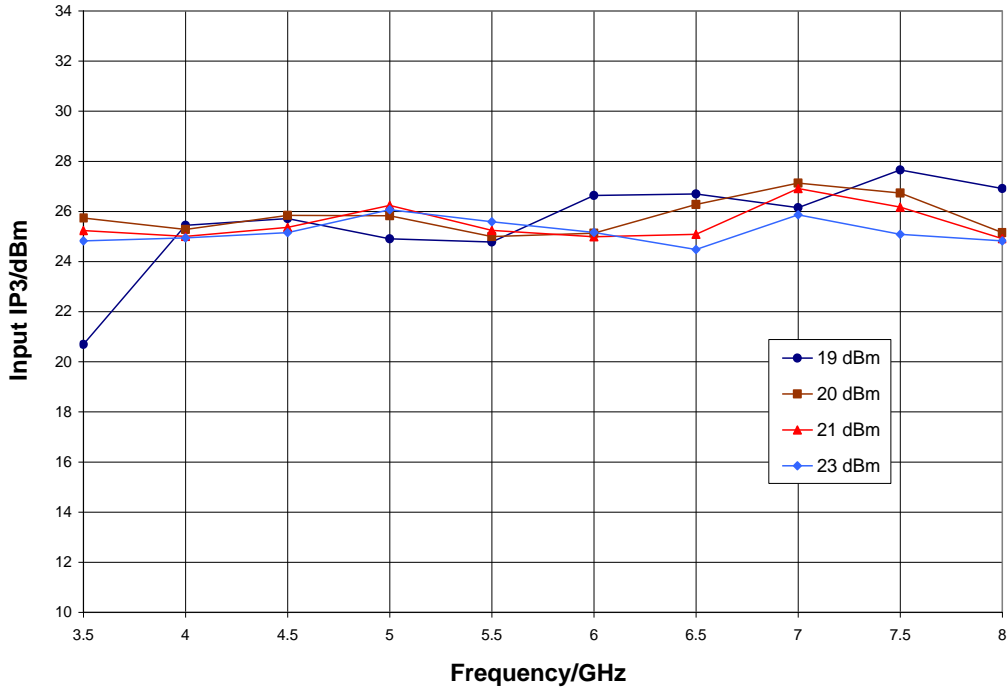

Upconverter Performance, Conversion Gain vs. LO Drive, IF = 100 MHz

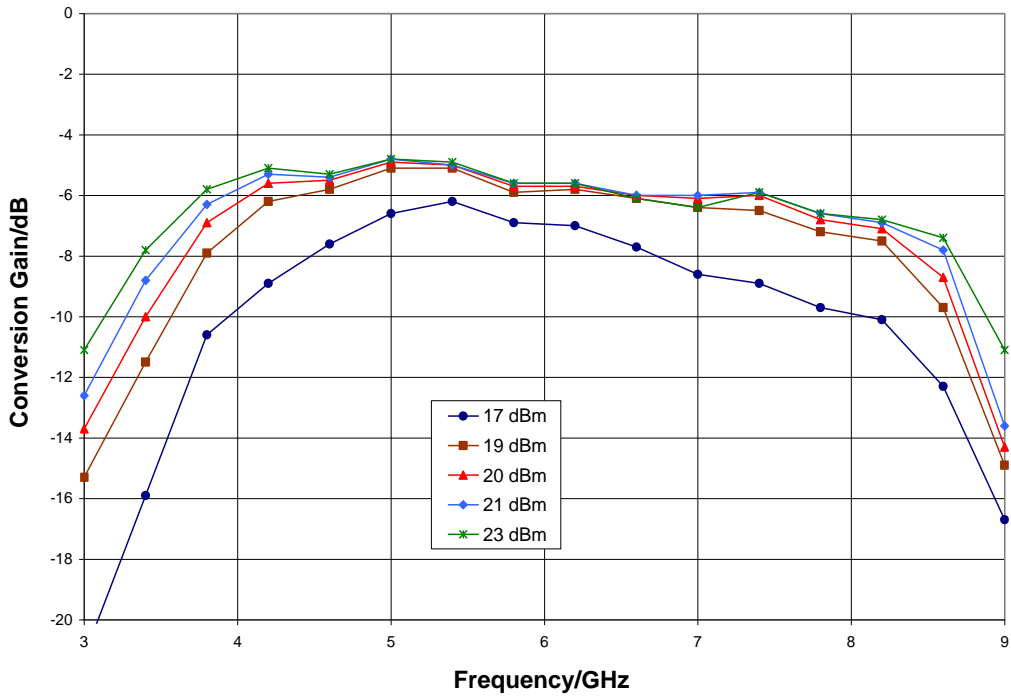

Typical Performance

Data Taken As IRM With External IF Hybrid

Upconverter Performance, Input IP3 vs. LO Drive, IF = 500 MHz

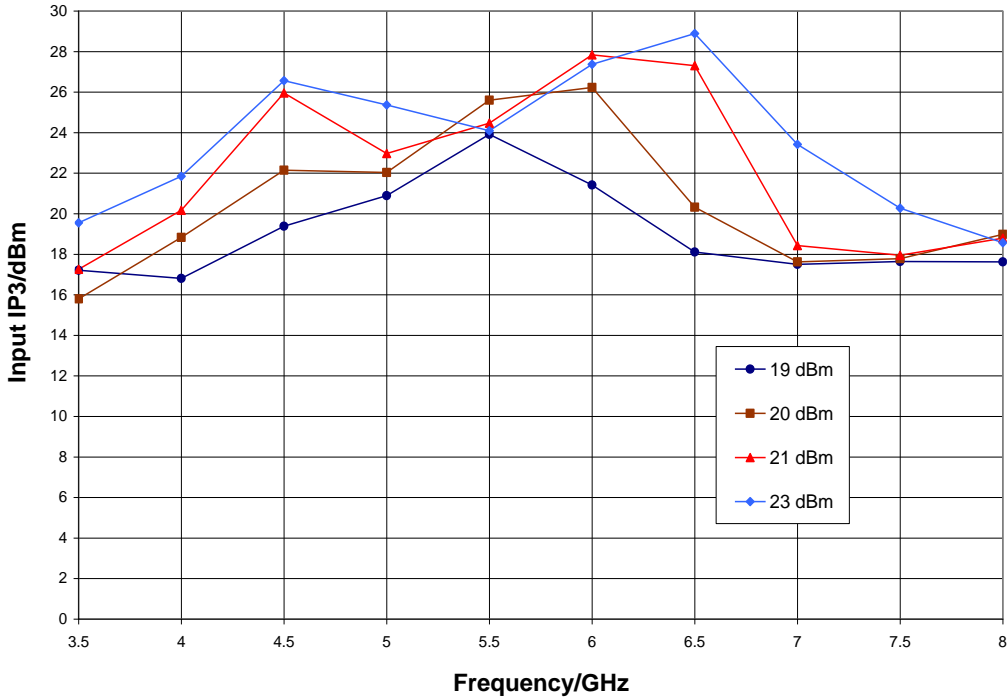

IF Bandwidth, LO = +20 dBm, Return Loss Data Taken Without IF Hybrid

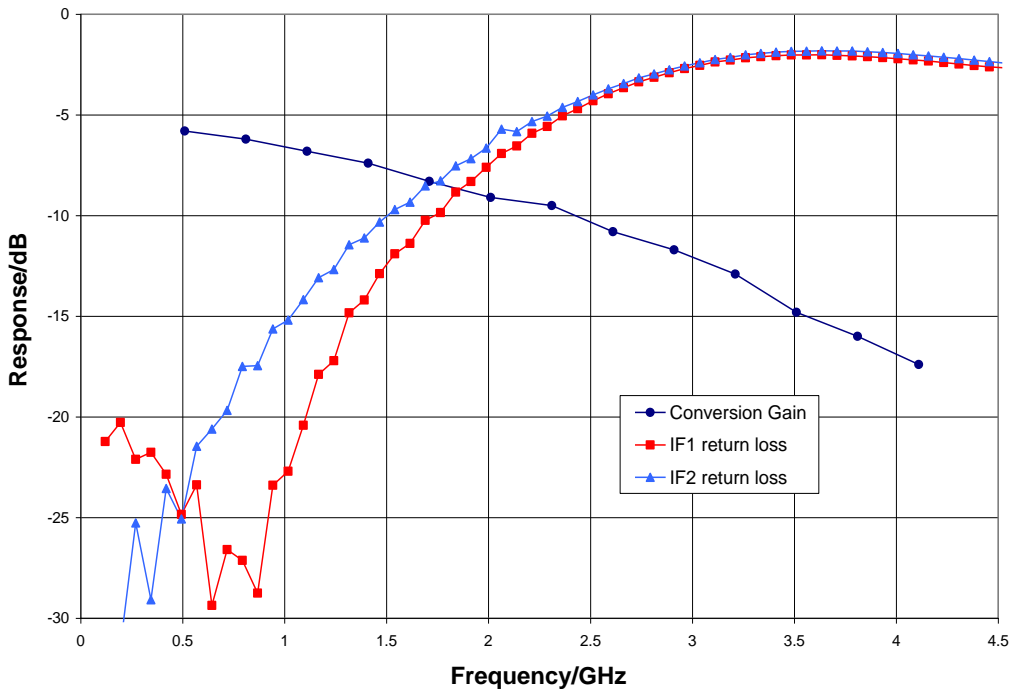

Typical Performance

Isolations, LO = +20 dBm. Data Taken Without IF Hybrid

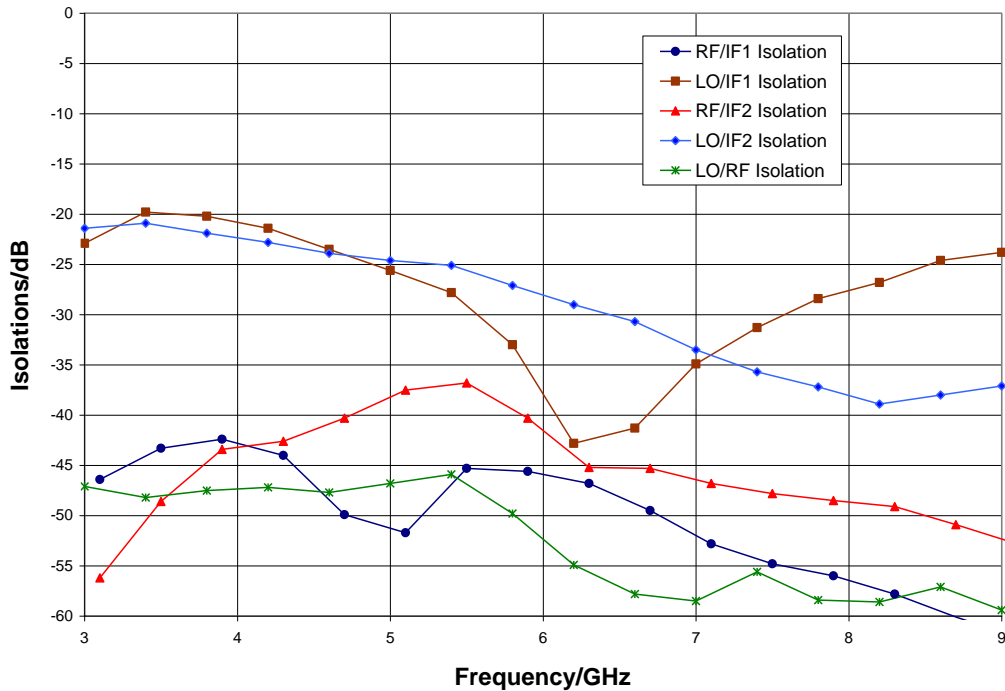

MxN Spurious Outputs to IF1, IF2

mRF	nLO				
	0	1	2	3	4
0	xx	-1 / -10	36 / 30	10 / 14	50 / 61
1	38 / 38	0	42 / 44	50 / 48	62 / 64
2	> 80	65 / 62	69 / > 80	> 80 / 66	> 80
3	> 80	> 80	> 80	> 80	68 / > 80
4	> 80	> 80	> 80	> 80	> 80

RF = 6.1 GHz @ -10 dBm

LO = 6.0 GHz @ +20 dBm

All values in dBc below the IF1 / IF2 output power level (1RF - 1LO)

Measurement performed without IF hybrid

Where two numbers are listed, they are the spur levels for the IF1 / IF2 ports

Mechanical Information

Package Information and Dimensions

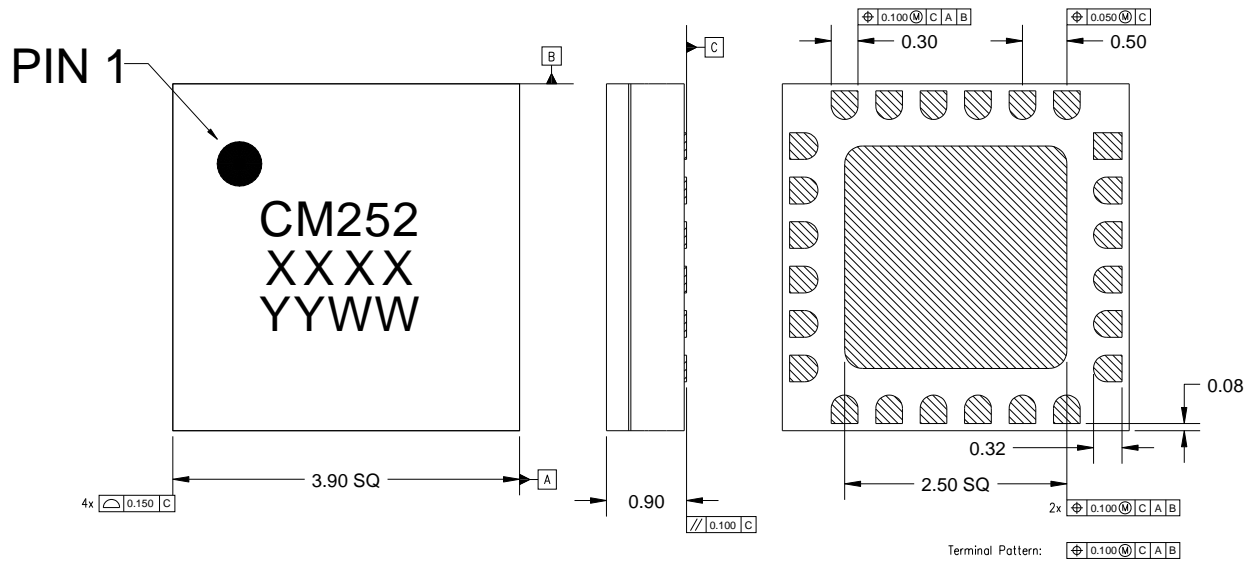

Notes:

1. All dimensions shown in mm.
2. Material: Black alumina
3. Lead finish
 - 3.1. Ni: 8.89um max, 1.27um min
 - 3.2. Pd: 0.17um max, 0.07um min
 - 3.3. Au: 0.254um max, 0.03um min
4. Marking: All marking shall be permanent and legible
5. Alternate pin #1 identifier is a single square pad

Recommended PCB Land Pattern

Qorvo recommends that the user develop the land pattern that will provide the best design for proper solder reflow and device attach for their specific application. Please review Qorvo Application Note AN 105 for a recommended land pattern approach.

Recommended Solder Reflow Profile

Qorvo recommends screen printing with belt furnace reflow to ensure proper solder reflow and device attach. Please review Qorvo Application Note AN 102 for a recommended solder reflow profile.

Pin Description

Pin Diagram

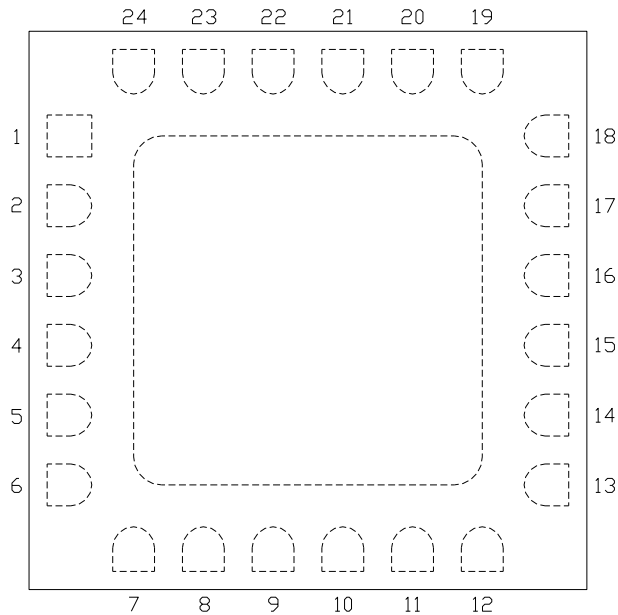

Functional Description

Pin	Function	Description	Schematic
1, 2, 6 - 8, 10, 13, 17 - 24	N/C	No connection required These pins may be connected to RF / DC ground	
3, 5, 12, 14, 16 and die paddle	Ground	Connect to RF / DC ground	
4	RF	This pin is DC coupled and matched to 50 ohms	
9	IF1	This pin is DC coupled. For applications not requiring operation to DC, this port should be DC blocked externally using a series capacitor whose value has been chosen to pass the necessary IF frequency range. For operation to DC, this pin must not source or sink more than 16 mA of current or part non-function or part failure may result.	
11	IF2		
15	LO	This pin is AC coupled and matched to 50 ohms	

Applications Information

Evaluation Board

The circuit board shown has been developed for optimized assembly at Qorvo. A sufficient number of via holes should be used to connect the top and bottom ground planes. As surface mount processes vary, careful process development is recommended.

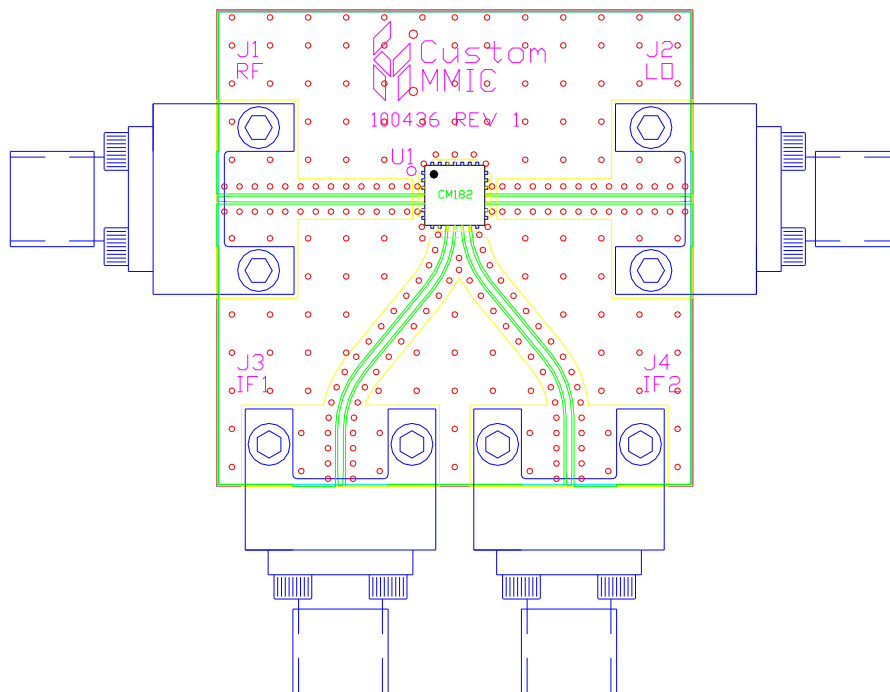
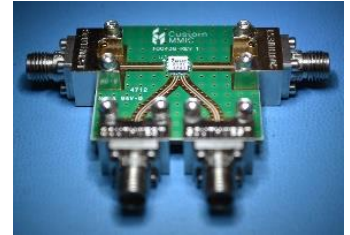

Bill of Material

Designator	Value	Description
J1 - J4		SMA End Launch Connector
U1		CMD252C4 I/Q Mixer
PCB		100436 Evaluation PCB

GaAs MMIC devices are susceptible to damage from Electrostatic Discharge. Proper precautions should be observed during handling, assembly and test.

Handling Precautions

Parameter	Rating	Standard
ESD – Human Body Model (HBM)	Class 1A	ESDA / JEDEC JS-001-2012
MSL – Moisture Sensitivity Level	Level 1	JEDEC standard IPC/JEDEC J-STD-020



Caution!
 ESD-Sensitive Device

RoHS Compliance

This part is compliant with 2011/65/EU RoHS directive (Restrictions on the Use of Certain Hazardous Substances in Electrical and Electronic Equipment) as amended by Directive 2015/863/EU.

This product also has the following attributes:

- Lead Free
- Antimony Free
- TBBP-A (C₁₅H₁₂Br₄O₂) Free
- SVHC Free
- Halogen Free
- PFOS Free

Contact Information

For the latest specifications, additional product information, worldwide sales and distribution locations:

Web: www.qorvo.com

Tel: 1-844-890-8163

Email: customer.support@qorvo.com

Important Notice

The information contained in this Data Sheet and any associated documents (“Data Sheet Information”) is believed to be reliable; however, Qorvo makes no warranties regarding the Data Sheet Information and assumes no responsibility or liability whatsoever for the use of said information. All Data Sheet Information is subject to change without notice. Customers should obtain and verify the latest relevant Data Sheet Information before placing orders for Qorvo® products. Data Sheet Information or the use thereof does not grant, explicitly, implicitly or otherwise any rights or licenses to any third party with respect to patents or any other intellectual property whether with regard to such Data Sheet Information itself or anything described by such information.

DATA SHEET INFORMATION DOES NOT CONSTITUTE A WARRANTY WITH RESPECT TO THE PRODUCTS DESCRIBED HEREIN, AND QORVO HEREBY DISCLAIMS ANY AND ALL WARRANTIES WITH RESPECT TO SUCH PRODUCTS WHETHER EXPRESS OR IMPLIED BY LAW, COURSE OF DEALING, COURSE OF PERFORMANCE, USAGE OF TRADE OR OTHERWISE, INCLUDING THE IMPLIED WARRANTIES OF MERCHANTABILITY AND FITNESS FOR A PARTICULAR PURPOSE. Without limiting the generality of the foregoing, Qorvo® products are not warranted or authorized for use as critical components in medical, life-saving, or life-sustaining applications, or other applications where a failure would reasonably be expected to cause severe personal injury or death. Applications described in the Data Sheet Information are for illustrative purposes only. Customers are responsible for validating that a particular product described in the Data Sheet Information is suitable for use in a particular application.

© 2022 Qorvo US, Inc. All rights reserved. This document is subject to copyright laws in various jurisdictions worldwide and may not be reproduced or distributed, in whole or in part, without the express written consent of Qorvo US, Inc. | QORVO® is a registered trademark of Qorvo US, Inc.