

Product Overview

The CMD274P4 is a wideband GaAs MMIC low phase noise amplifier housed in a leadless surface mount package that is ideally suited for military, space, and communications systems. At 10 GHz the device delivers 17 dB of gain, a saturated output power of +22 dBm and a noise figure of 3.2 dB. Also, with an input signal of 10 GHz the amplifier provides low phase noise performance of -165 dBc/Hz at 10 kHz offset. The CMD274P4 is a 50 ohm matched design which eliminates the need for external DC blocks and RF port matching.

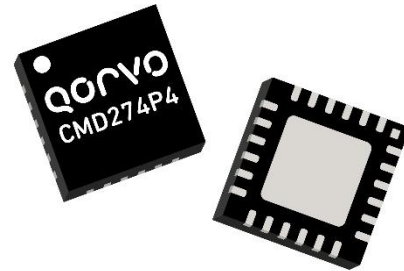

Functional Block Diagram

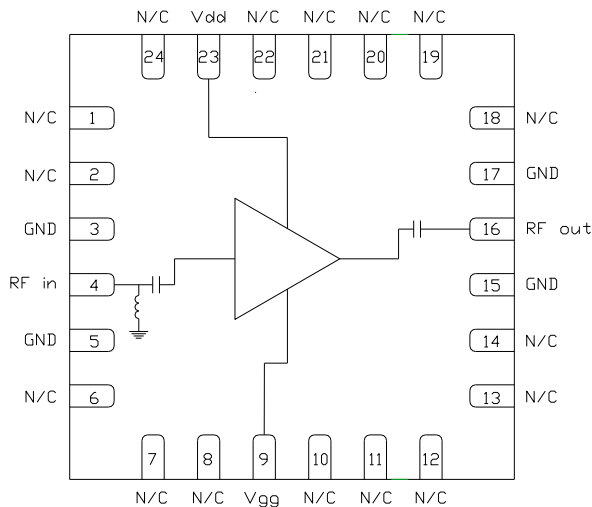

Key Features

- Ultra-Wideband Performance
- Low Phase Noise
- Low Current Consumption
- Pb-Free RoHs Compliant 4x4 mm QFN Package

Ordering Information

Part No.	Description
CMD274P4	250 Piece 7" Reel
CMD274P4-EVB	1 Piece Bag

Electrical Performance ($V_{dd} = 5.0\text{ V}$, $V_{gg} = 3.0\text{ V}$, $T_A = 25^\circ\text{ C}$, $F = 10\text{ GHz}$)

Parameter	Min	Typ	Max	Units
Frequency Range		2 - 20		GHz
Gain		17		dB
Input Return Loss		12		dB
Output Return Loss		13		dB
Noise Figure		3.2		dB
Output P_{1dB}		19		dBm
Saturated Output Power		22		dBm
Phase Noise @ 10 kHz Offset		-165		dBc/Hz
Supply Current		86		mA

Absolute Maximum Ratings

Parameter	Rating
Drain Voltage, V_{dd}	7.5 V
Gate Voltage, V_{gg}	3.5 V
RF Input Power	+15 dBm
Channel Temperature, T_{ch}	150° C
Power Dissipation, P_{diss}	720 mW
Thermal Resistance θ_{JC}	90.3° C/W
Operating Temperature	-40 to 85° C
Storage Temperature	-55 to 150° C

Exceeding any one or combination of the maximum ratings may cause permanent damage to the device.

Recommended Operating Conditions

Parameter	Min	Typ.	Max	Units
V_{dd}	4.0	5.0	7.0	V
I_{dd}		86		mA
V_{gg}	2.0	3.0	3.3	V
I_{gg}		5		mA

Electrical performance is measured at specific test conditions. Electrical specifications are not guaranteed over all recommended operating conditions.

Electrical Specifications ($V_{dd} = 5.0$ V, $V_{gg} = 3.0$ V, $T_A = 25^\circ$ C)

Parameter	Min	Typ.	Max	Min	Typ.	Max	Units
Frequency Range		2 - 10			10 - 20		GHz
Gain	14	17.5		14	17.5		dB
Noise Figure		6			3.5		dB
Input Return Loss		12			12		dB
Output Return Loss		13			12		dB
Output P_{1dB}	16.5	19.5		13	17		dBm
Saturated Output Power		22			21		dBm
Output IP3		30.5			29.5		dBm
Phase Noise @ 10 kHz Offset		-165			-165		dBc/Hz
Supply Current	60	86	115	60	86	115	mA

Typical Performance

Broadband Performance, $V_{dd} = 5.0 \text{ V}$, $V_{gg} = 3.0 \text{ V}$, $I_{dd} = 74 \text{ mA}$, $T_A = 25^\circ \text{ C}$

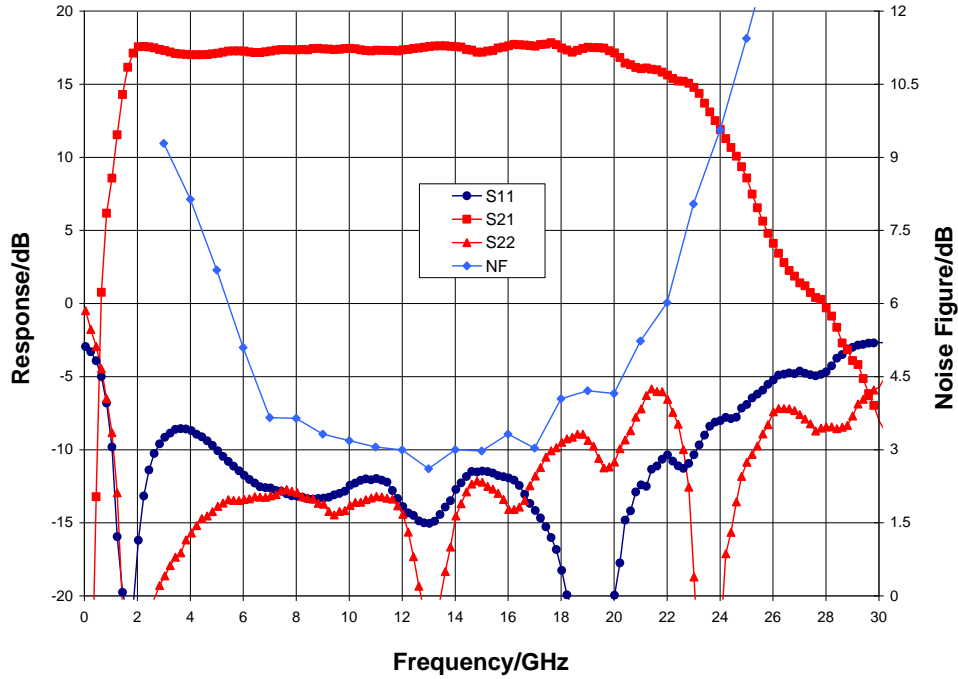

Narrow-band Performance, $V_{dd} = 5.0 \text{ V}$, $V_{gg} = 3.0 \text{ V}$, $I_{dd} = 74 \text{ mA}$, $T_A = 25^\circ \text{ C}$

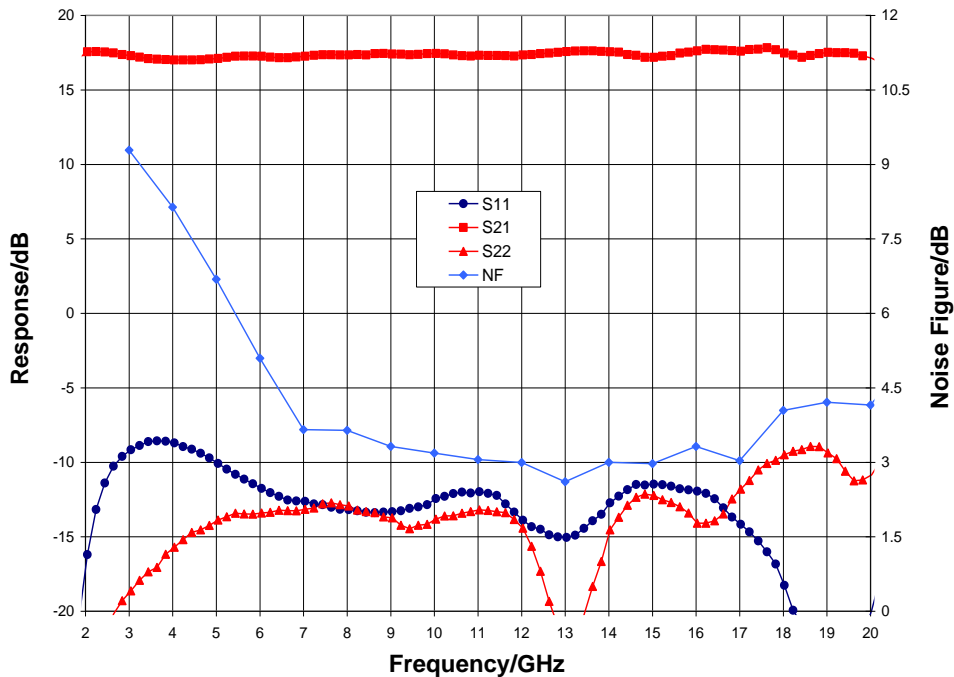

Typical Performance

Additive Phase Noise @ Psat, V_{dd} = 5.0 V, V_{gg} = 3.0 V, T_A = 25° C

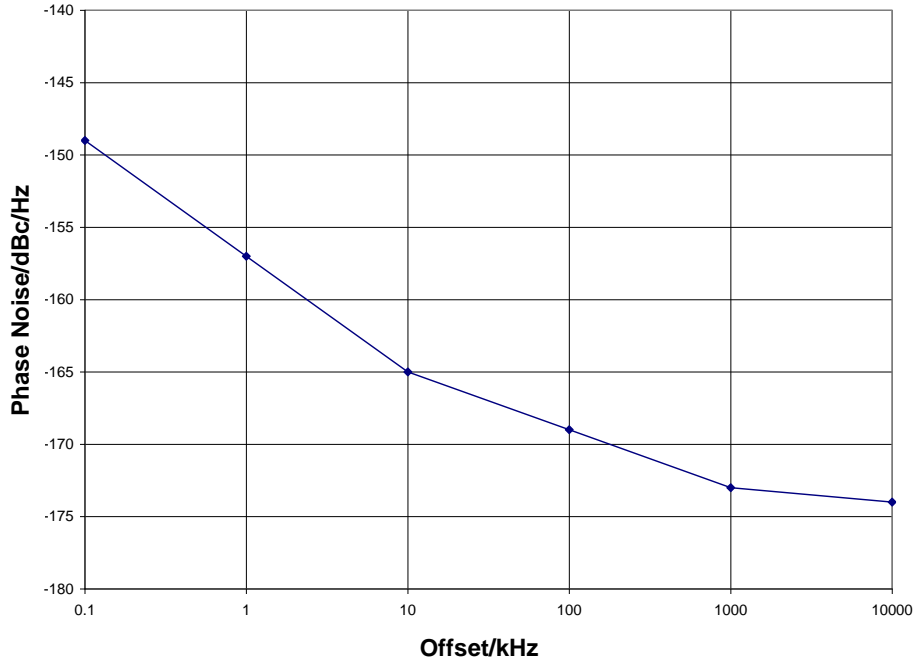

Gain vs. Temperature, V_{dd} = 5.0 V, V_{gg} = 3.0 V

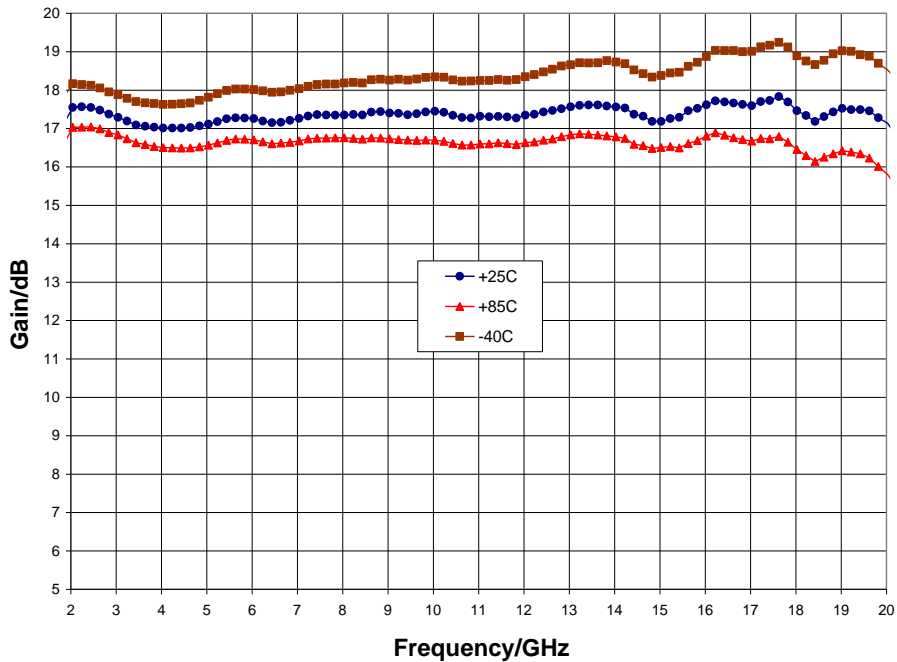

Typical Performance

Pin vs. Pout, $V_{dd} = 5.0\text{ V}$, $V_{gg} = 3.0\text{ V}$, Temp. = 25C

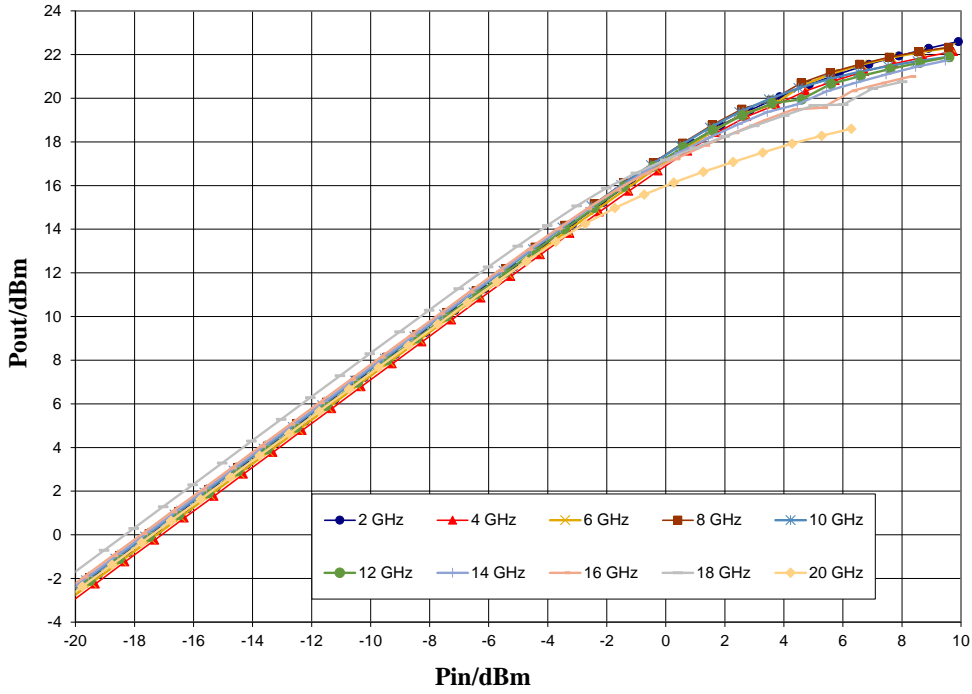

P1dB vs. Temperature, $V_{dd} = 5.0\text{ V}$, $V_{gg} = 3.0\text{ V}$

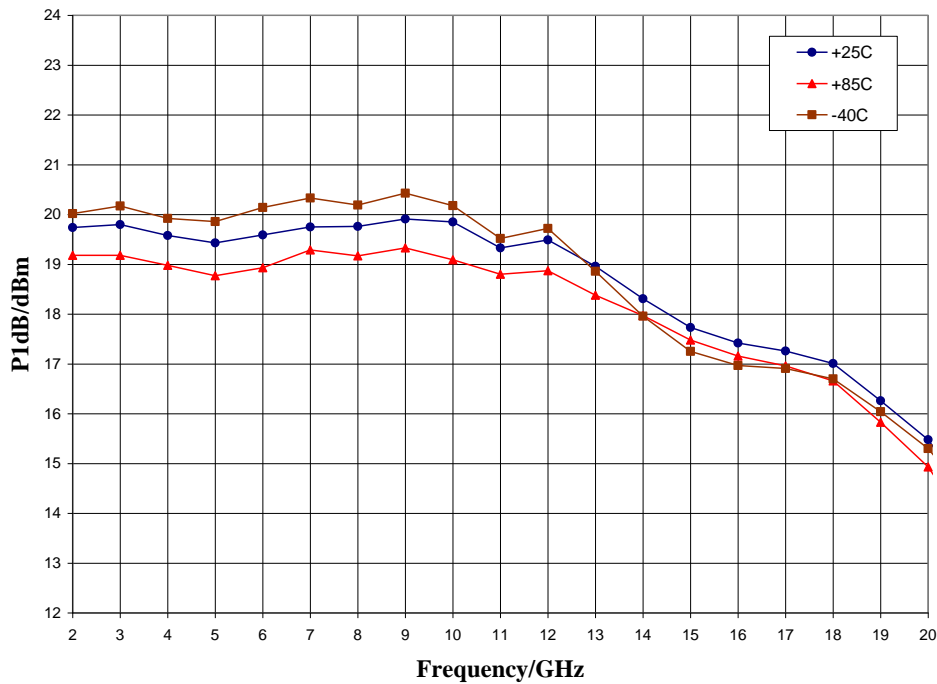

Typical Performance

Psat vs. Temperature, $V_{dd} = 5.0\text{ V}$, $V_{gg} = 3.0\text{ V}$

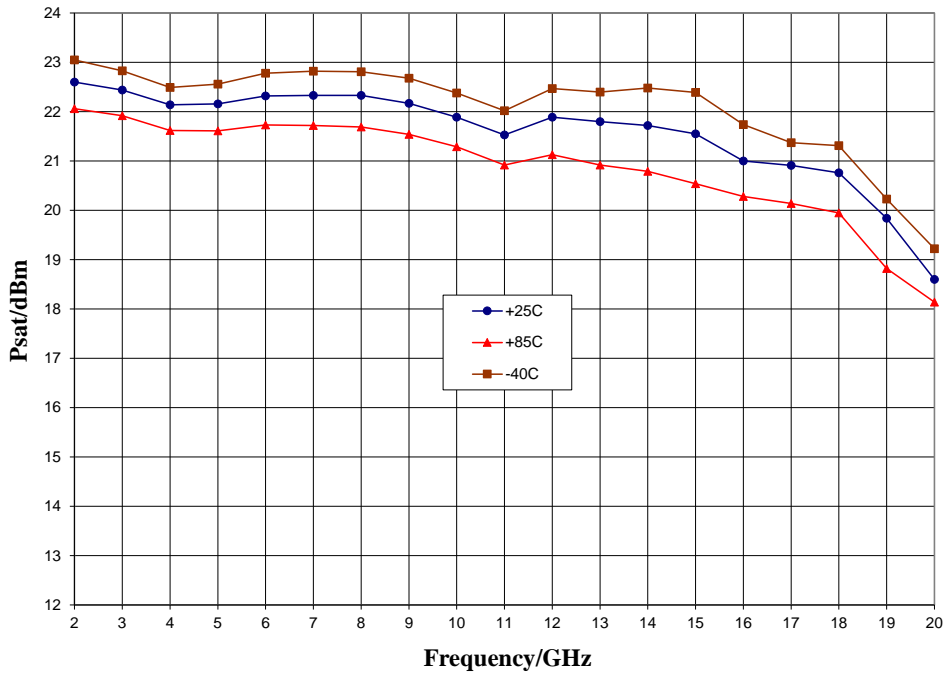

Typical Performance

Output IP3 vs. Temperature, $V_{dd} = 5.0\text{ V}$, $V_{gg} = 3.0\text{ V}$

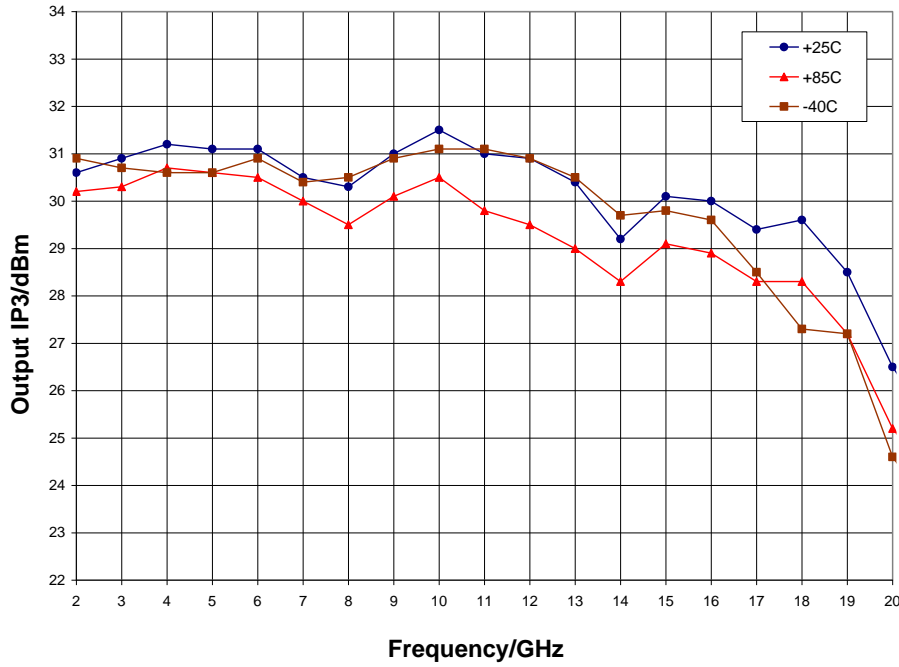

Noise Figure vs. Temperature, $V_{dd} = 5.0\text{ V}$, $V_{gg} = 3.0\text{ V}$

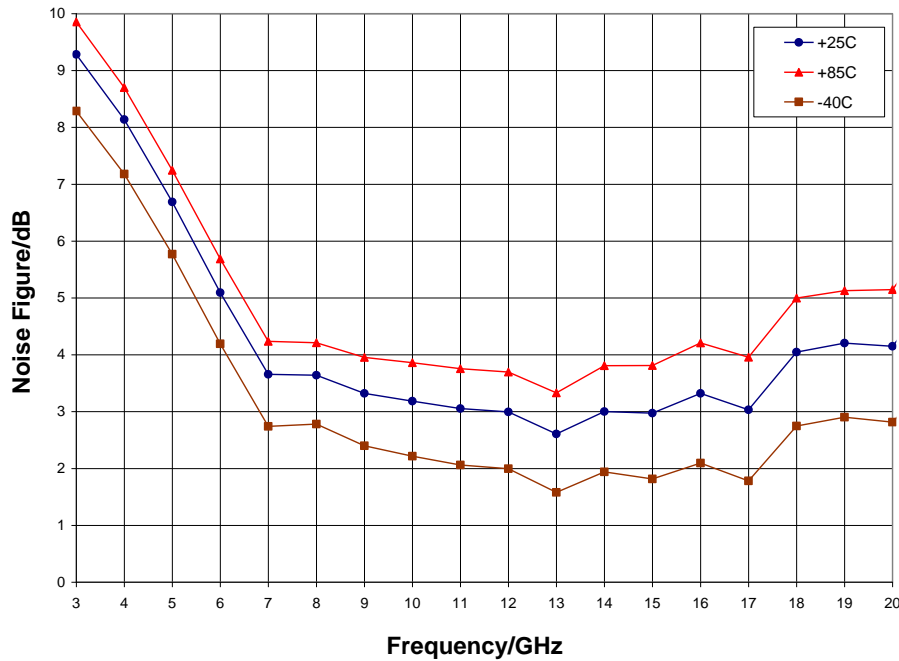

Mechanical Information

Package Information and Dimensions

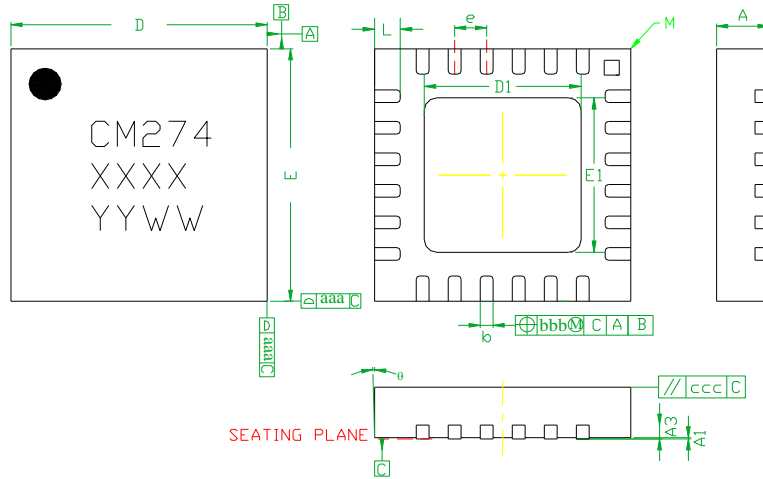

SYMBOLS	DIMENSIONS IN MILLIMETERS		
	MIN	NOM	MAX
A	0.80	0.90	1.00
A1	0	0.02	0.05
A3	---	0.25REF.	---
b	0.18	0.23	0.30
D	3.85	4.00	4.15
D1	2.40	2.50	2.60
E	3.85	4.00	4.15
E1	2.40	2.50	2.60
e	---	0.50BSC	---
L	0.30	0.40	0.50
ø	0	---	12
aaa	---	0.25	---
bbb	---	0.10	---
ccc	---	0.10	---
M	---	---	0.05

Notes:

1. Dimensions are in millimeters
2. RoHs compliant mold compound
3. Lead frame material: Copper alloy
4. Lead finish: 100% matte Sn
5. Indicated dimension/tolerance applies to leads and exposed pads
6. Marking: All marking shall be permanent and legible
 - a. Line 1: Part number
 - i. Example: CMD274P4 shall be marked as CM274
 - b. Line 2: Lot number
 - c. Line 3: Date code - Last 2 digits of the year of manufacture followed by a 2-digit week code
7. Alternate pin #1 identifier is a single square pad
8. Alternate die paddle may have chamfered corners

Recommended PCB Land Pattern

Qorvo recommends that the user develop the land pattern that will provide the best design for proper solder reflow and device attach for their specific application. Please review Qorvo Application Note AN 105 for a recommended land pattern approach.

Recommended Solder Reflow Profile

Qorvo recommends screen printing with belt furnace reflow to ensure proper solder reflow and device attach. Please review Qorvo Application Note AN 102 for a recommended solder reflow profile.

Pin Description

Pin Diagram

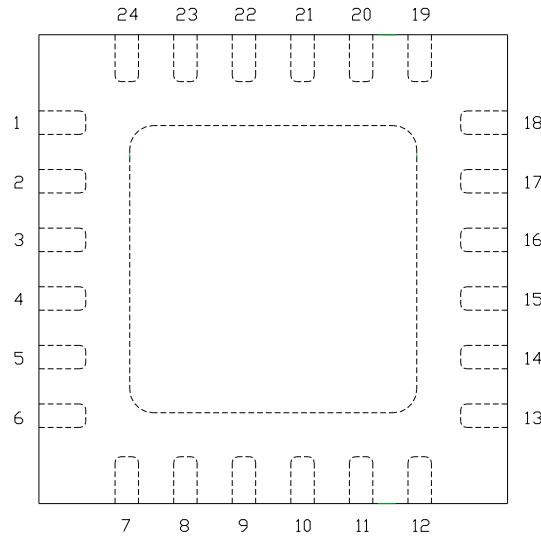

Functional Description

Pad	Function	Description	Schematic
1, 2, 6 - 8, 10 - 14, 18 - 22, 24	N/C	No connection required These pins may be connected to RF / DC ground	
3, 5, 15, 17 and die paddle	Ground	Connect to RF / DC ground	
4	RF in	DC blocked and 50 ohm matched	
23	V _{dd}	Power supply voltage Decoupling and bypass caps required	
16	RF out	DC blocked and 50 ohm matched	
9	V _{gg}	Power supply voltage Decoupling and bypass caps required	

Applications Information

Application Circuit

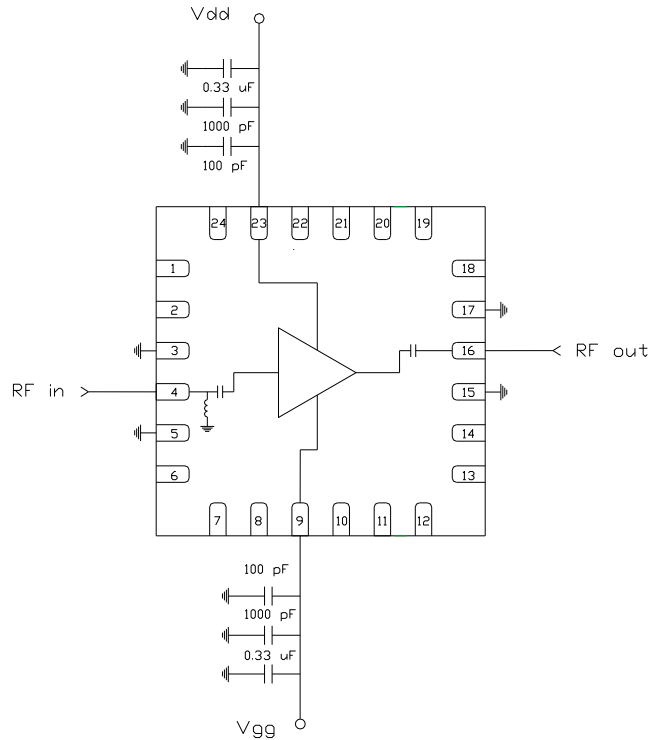

Biasing and Operation

The CMD274P4 is biased with a positive drain supply and positive gate supply. Performance is optimized when the drain voltage is set to +5.0 V. The recommended gate voltage is +3.0 V. The preferred biasing procedure is as follows:

Turn ON procedure:

1. Apply drain voltage V_{dd} and set to +5 V
2. Apply gate voltage V_{gg} and set to +3 V

Turn OFF procedure:

1. Turn off gate voltage V_{gg}
2. Turn off drain voltage V_{dd}

The preferred biasing procedure has been proven to be robust and should be used whenever possible. However, the CMD274P4 does allow for simultaneous biasing (applying V_{dd} and V_{gg} at the same time), and the use of a single voltage supply.

Refer to Application Note 103: Amplifier Biasing Techniques for instructions on how to implement a single supply biasing scheme.

For either approach, RF power can be applied at any time.

Applications Information

Evaluation Board

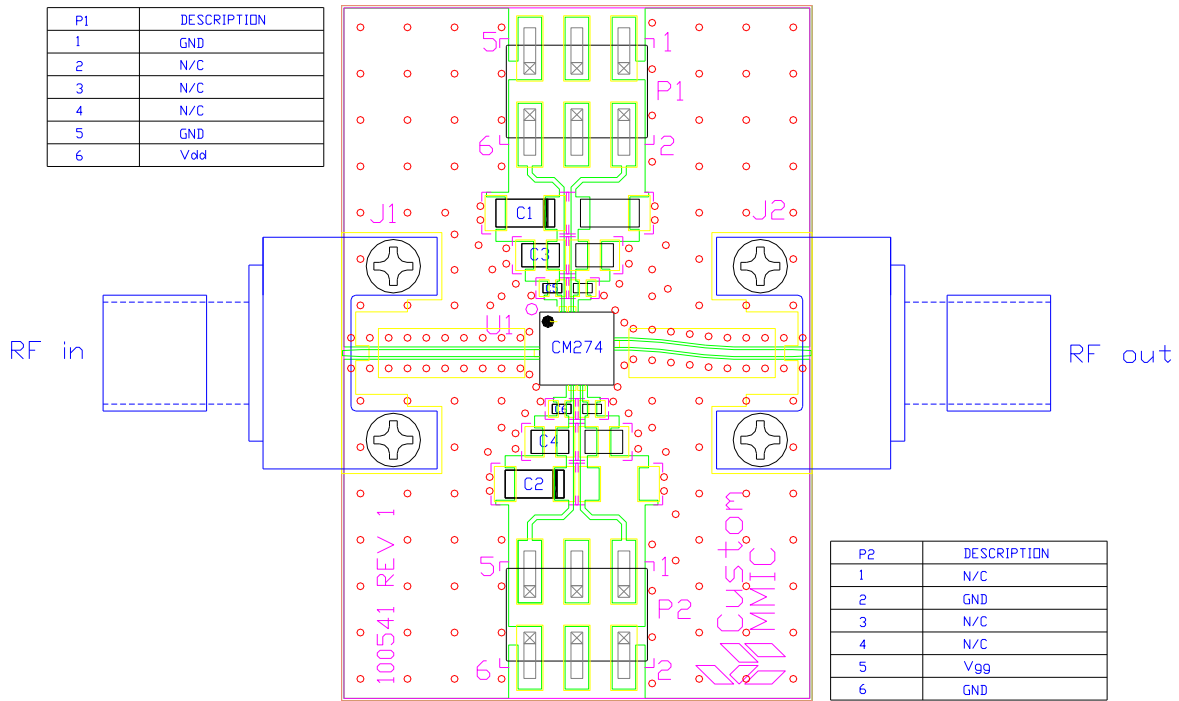

Bill of Material

Designator	Value	Description
J1, J2		SMA End Launch Connector
P1, P2		6 Pin DC Header
C1, C2	0.33 μ F	Capacitor, Tantalum
C3, C4	1000 pF	Capacitor, 0603
C5, C6	100 pF	Capacitor, 0402
U1		CMD274P4 Low Phase Noise Amplifier
PCB		100541 Evaluation PCB

GaAs MMIC devices are susceptible to damage from Electrostatic Discharge. Proper precautions should be observed during handling, assembly and test.

Handling Precautions

Parameter	Rating	Standard
ESD – Human Body Model (HBM)	Class 1A	ESDA / JEDEC JS-001-2012
MSL – Moisture Sensitivity Level	Level 1	JEDEC standard IPC/JEDEC J-STD-020



Caution!
 ESD-Sensitive Device

RoHS Compliance

This part is compliant with 2011/65/EU RoHS directive (Restrictions on the Use of Certain Hazardous Substances in Electrical and Electronic Equipment) as amended by Directive 2015/863/EU.

This product also has the following attributes:

- Lead Free
- Halogen Free (Chlorine, Bromine)
- Antimony Free
- TBBP-A (C₁₅H₁₂Br₄O₂) Free
- PFOS Free
- SVHC Free

Contact Information

For the latest specifications, additional product information, worldwide sales and distribution locations:

Web: www.qorvo.com

Tel: 1-844-890-8163

Email: customer.support@qorvo.com

Important Notice

The information contained in this Data Sheet and any associated documents (“Data Sheet Information”) is believed to be reliable; however, Qorvo makes no warranties regarding the Data Sheet Information and assumes no responsibility or liability whatsoever for the use of said information. All Data Sheet Information is subject to change without notice. Customers should obtain and verify the latest relevant Data Sheet Information before placing orders for Qorvo® products. Data Sheet Information or the use thereof does not grant, explicitly, implicitly or otherwise any rights or licenses to any third party with respect to patents or any other intellectual property whether with regard to such Data Sheet Information itself or anything described by such information.

DATA SHEET INFORMATION DOES NOT CONSTITUTE A WARRANTY WITH RESPECT TO THE PRODUCTS DESCRIBED HEREIN, AND QORVO HEREBY DISCLAIMS ANY AND ALL WARRANTIES WITH RESPECT TO SUCH PRODUCTS WHETHER EXPRESS OR IMPLIED BY LAW, COURSE OF DEALING, COURSE OF PERFORMANCE, USAGE OF TRADE OR OTHERWISE, INCLUDING THE IMPLIED WARRANTIES OF MERCHANTABILITY AND FITNESS FOR A PARTICULAR PURPOSE. Without limiting the generality of the foregoing, Qorvo® products are not warranted or authorized for use as critical components in medical, life-saving, or life-sustaining applications, or other applications where a failure would reasonably be expected to cause severe personal injury or death. Applications described in the Data Sheet Information are for illustrative purposes only. Customers are responsible for validating that a particular product described in the Data Sheet Information is suitable for use in a particular application.

© 2023 Qorvo US, Inc. All rights reserved. This document is subject to copyright laws in various jurisdictions worldwide and may not be reproduced or distributed, in whole or in part, without the express written consent of Qorvo US, Inc. | QORVO® is a registered trademark of Qorvo US, Inc.