

Product Overview

The CMD297P34 is an analog phase shifter housed in a leadless 3x4 mm plastic surface mount package which operates from 5 to 18 GHz. The phase shifter utilizes a single positive control voltage of 0V to +10V to control relative phase shift over a 530 degree range at 7 GHz and a 220 degree range at 12 GHz. The CMD297P34 has consistent insertion loss versus phase shift and the phase shift is monotonic with respect to control voltage. The phase shifter is a 50 ohm matched design which eliminates the need for external DC blocks and RF port matching.

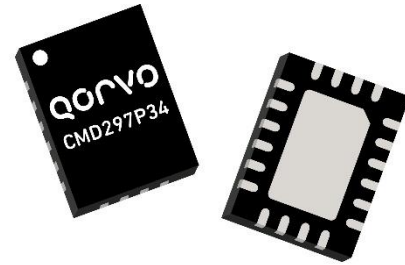

Functional Block Diagram

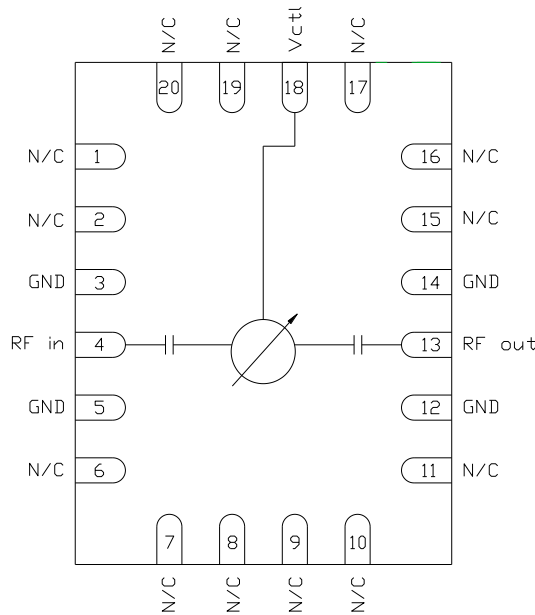

Key Features

- Wide Bandwidth
- Wide Phase Shift Range
- Single Positive Control Voltage
- Pb-Free RoHs Compliant 3x4 QFN Package

Ordering Information

Part No.	Description
CMD297P34	5-18 GHz Analog Phase Shifter, 100 Piece 7" Reel
CMD297P34-EVB	Evaluation Board

Electrical Performance ($V_{ctl} = 0\text{ V to }+10\text{ V}$, $T_A = 25\text{ }^\circ\text{C}$, $F = 12\text{ GHz}$)

Parameter	Min	Typ	Max	Units
Frequency Range		5 - 18		GHz
Phase Shift Range		220		degrees
Insertion Loss		3.2		dB
Input Return Loss		14		dB
Output Return Loss		13		dB
Phase Voltage Sensitivity		22		deg/Volt

Absolute Maximum Ratings

Parameter	Rating
Control Voltage, V_{ctl}	+ 11 V
Reverse Current	5 mA
RF Input Power	+30 dBm
Channel Temperature, T_{ch}	150 °C
Power Dissipation, P_{diss}	2 W
Thermal Resistance, θ_{JC}	32.2 °C/W
Operating Temperature	-40 to 85 °C
Storage Temperature	-55 to 150 °C

Exceeding any one or combination of the maximum ratings may cause permanent damage to the device.

Recommended Operating Conditions

Parameter	Min	Typ	Max	Units
V_{ctl}	0		10	V

Electrical performance is measured at specific test conditions. Electrical specifications are not guaranteed over all recommended operating conditions.

Electrical Specifications ($V_{ctl} = 0\text{ V to }+10\text{ V}$, $T_A = 25\text{ °C}$)

Parameter	Min	Typ	Max	Min	Typ	Max	Min	Typ	Max	Units
Frequency Range	5 - 10			10 - 13			13 - 18			GHz
Phase Shift Range	230	480		140	240		45	130		degrees
Insertion Loss		7.3	17		3.7	7		2.7	9	dB
Input Return Loss		10			13			7		dB
Output Return Loss		10			13			7		dB
Control Voltage Range	0		10	0		10	0		10	Volts
Phase Voltage Sensitivity		47			24			13		deg/Volt
Phase Temperature Sensitivity		0.15			0.1			0.05		deg/°C

Typical Performance

Insertion Loss vs. Control Voltage @ 12 GHz

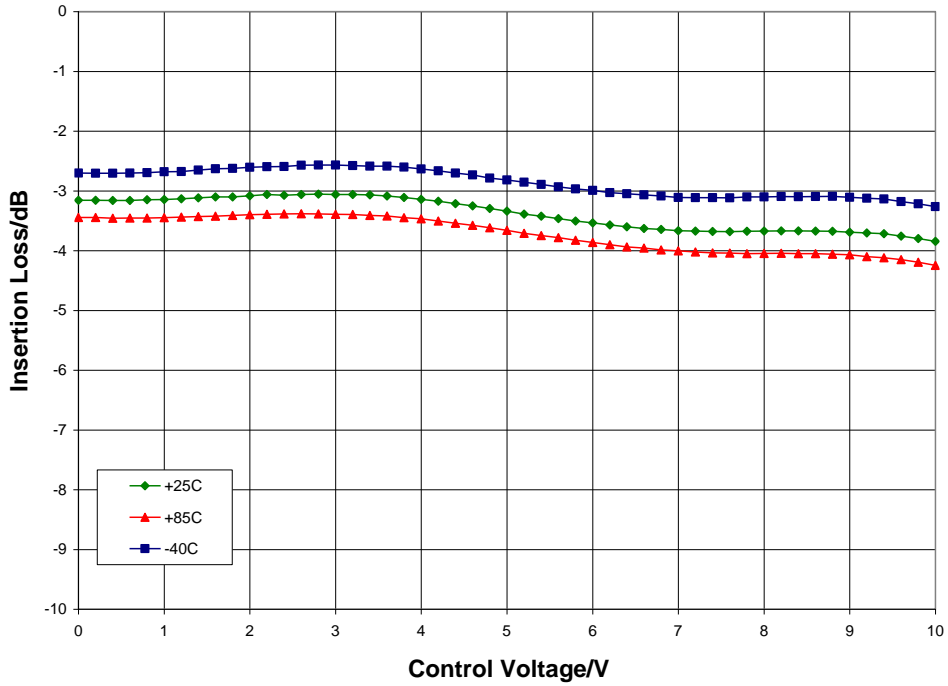

Phase Shift vs. Control Voltage, T_A = 25 °C

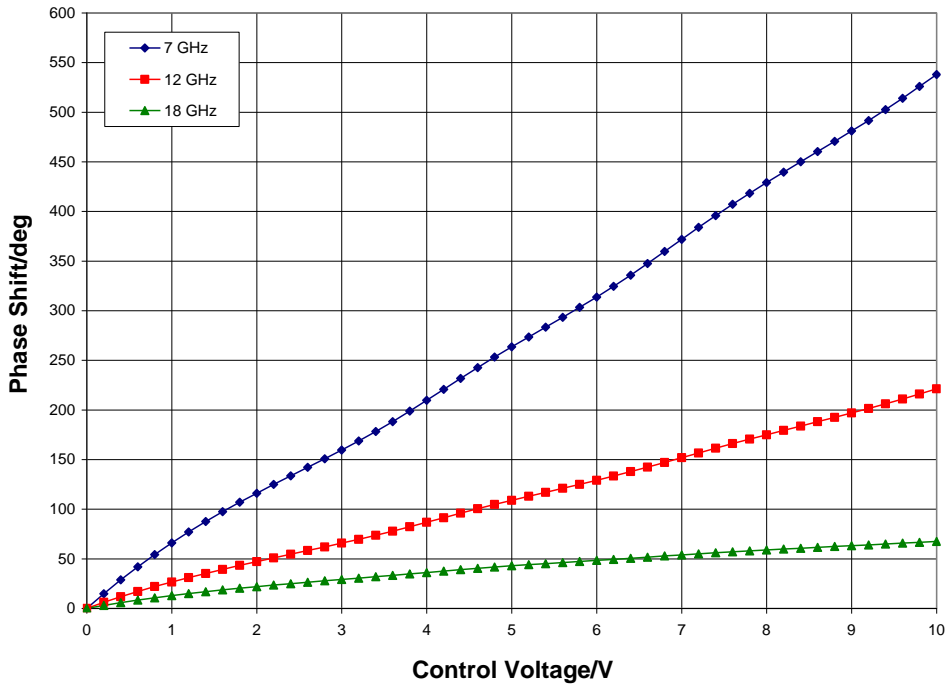

Typical Performance

Phase Shift vs. Frequency @ $V_{ctl} = 10\text{ V}$ (Relative to $V_{ctl} = 0\text{ V}$)

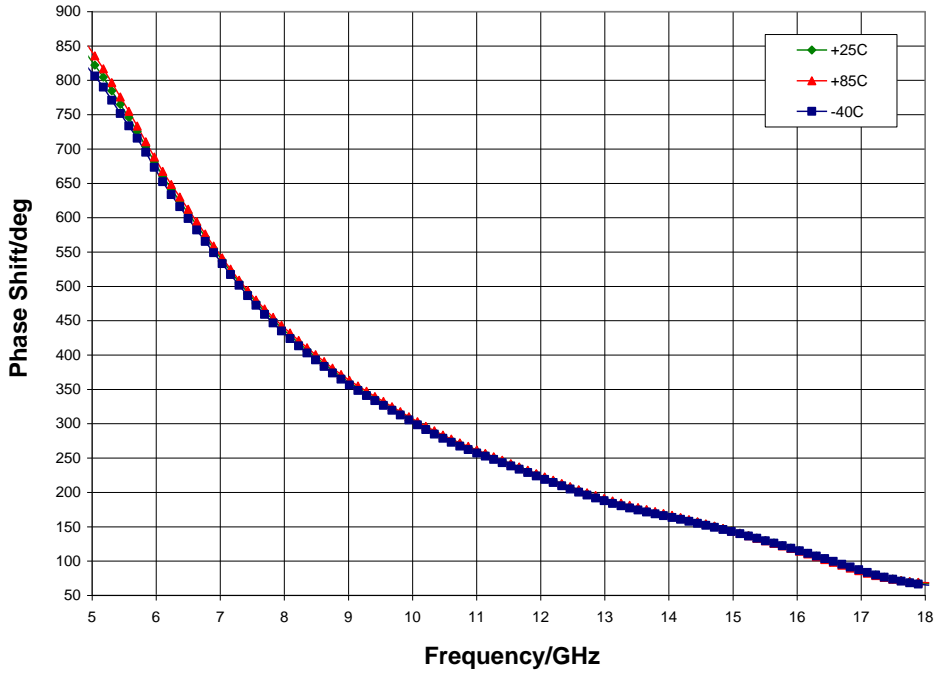

Insertion Loss vs. Frequency, $T_A = 25\text{ °C}$

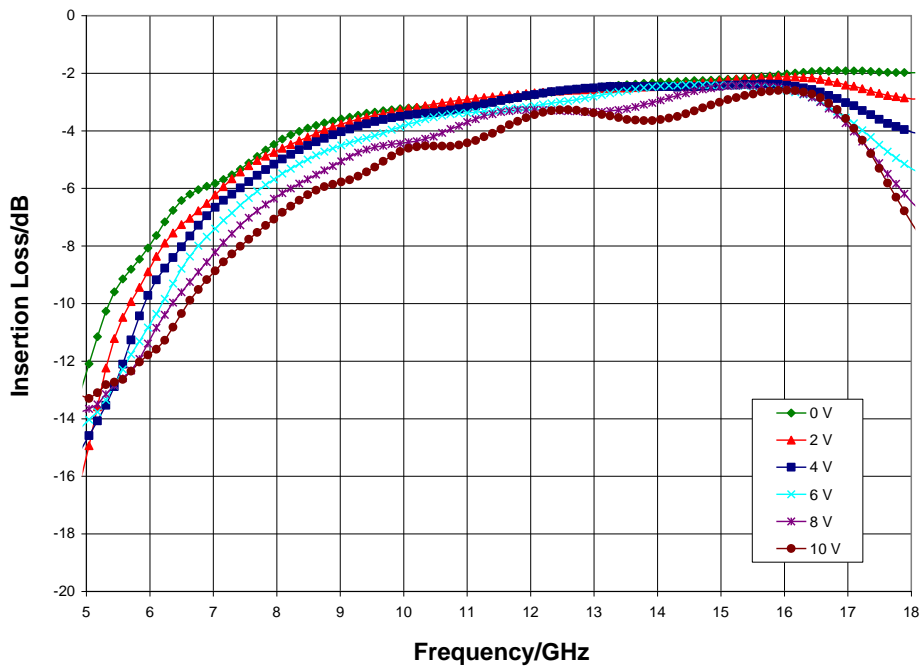

Typical Performance

Input Return Loss, $T_A = 25\text{ }^\circ\text{C}$

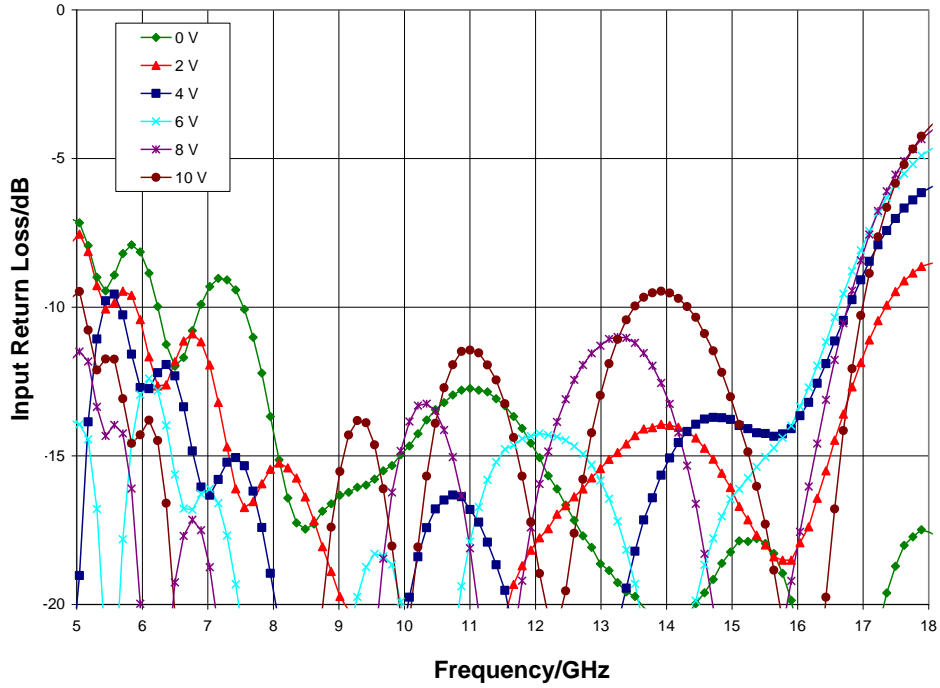

Output Return Loss, $T_A = 25\text{ }^\circ\text{C}$

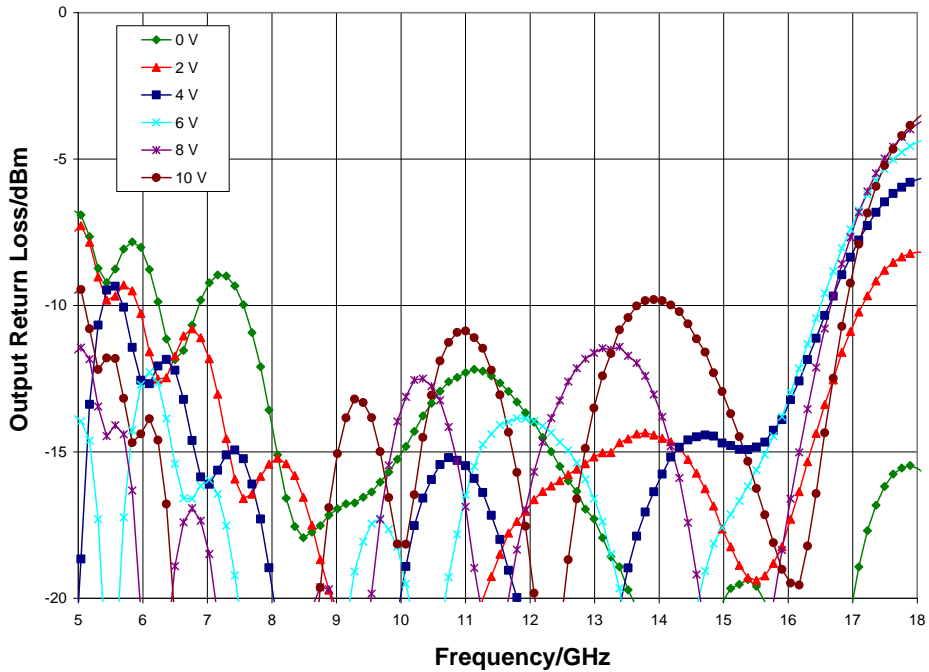

Typical Performance

Insertion Loss vs. Pin, $V_{ctl} = 0\text{ V}$, $T_A = 25\text{ °C}$

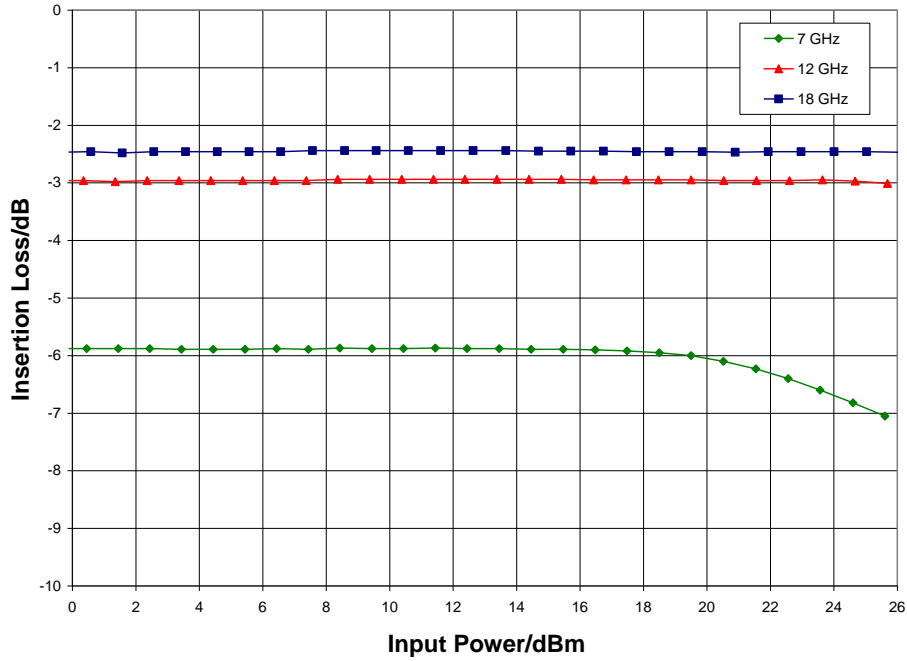

Input IP3 vs. Control Voltage, $T_A = 25\text{ °C}$

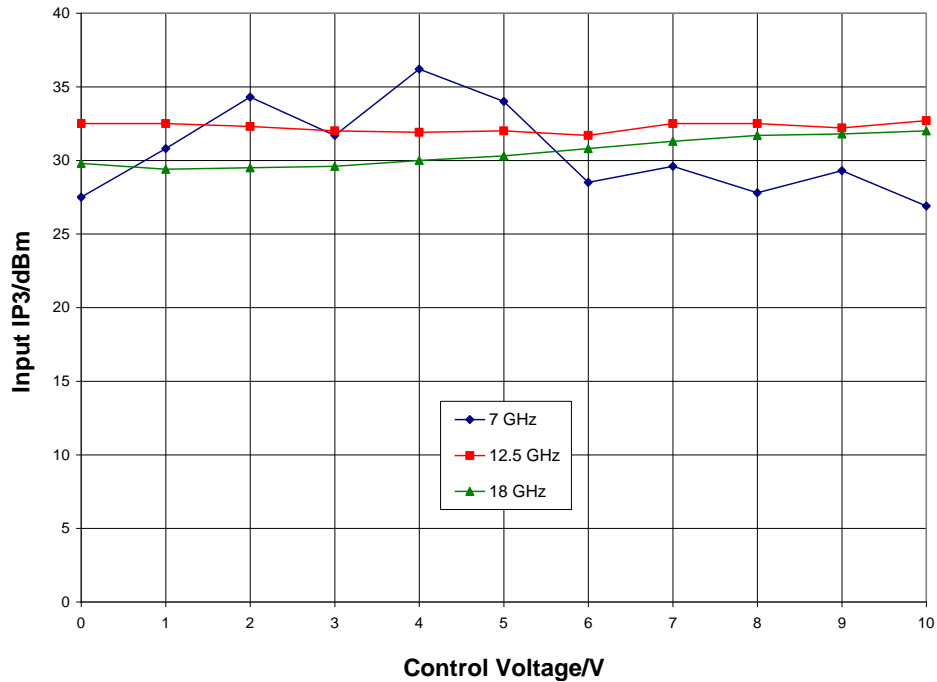

Mechanical Information

Package Information and Dimensions

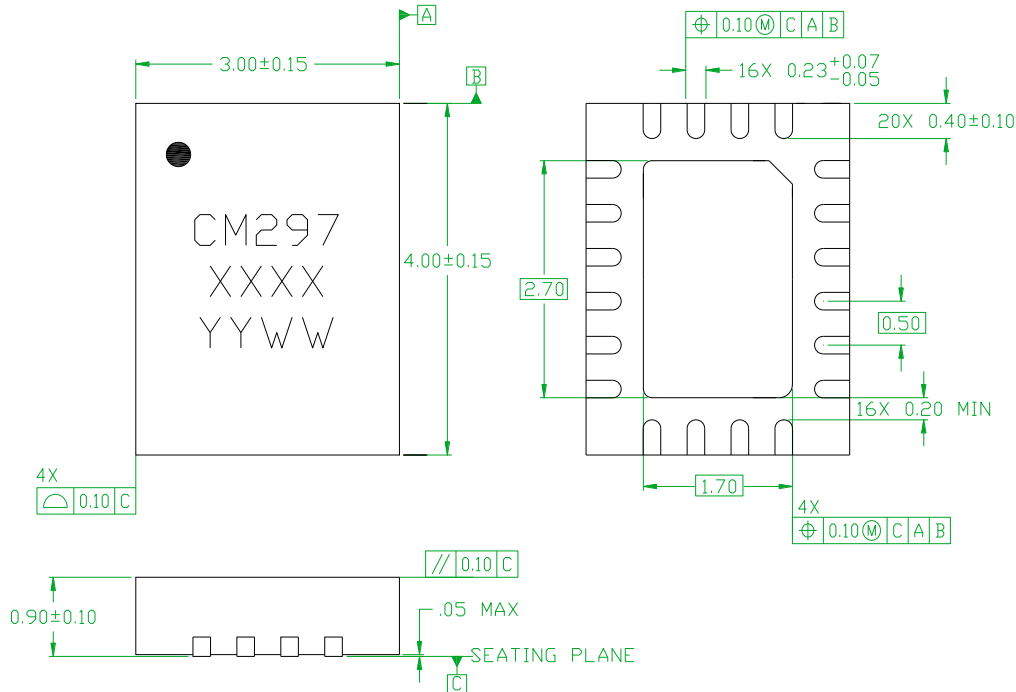

Notes:

1. Dimensions are in millimeters
2. RoHs compliant mold compound
3. Lead frame material: Copper alloy
4. Lead finish: 100% matte Sn
5. Indicated dimension/tolerance applies to leads and exposed pad

Recommended PCB Land Pattern

Qorvo recommends that the user develop the land pattern that will provide the best design for proper solder reflow and device attach for their specific application. Please review Qorvo Application Note AN 105 for a recommended land pattern approach.

Recommended Solder Reflow Profile

Qorvo recommends screen printing with belt furnace reflow to ensure proper solder reflow and device attach. Please review Qorvo Application Note AN 102 for a recommended solder reflow profile.

Pin Description

Pin Diagram

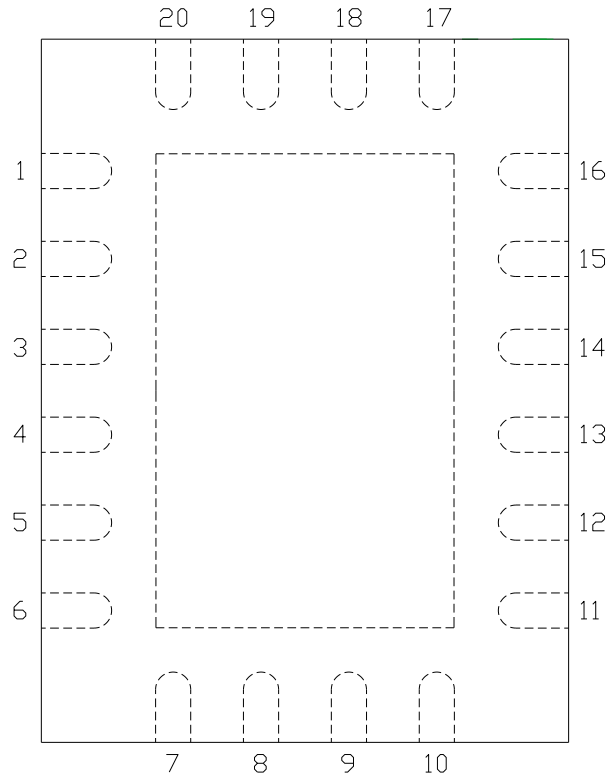

Functional Description

Pin	Function	Description	Schematic
1, 2, 6 - 11, 15 - 17, 19, 20	N/C	No connection required These pins may be connected to RF / DC ground	
4	RF in	DC blocked and 50 ohm matched	
13	RF out	DC blocked and 50 ohm matched	
18	V _{ctl}	Control voltage	
3, 5, 12, 14 and die paddle	Ground	Connect to RF / DC ground	

Applications Information

Application Circuit

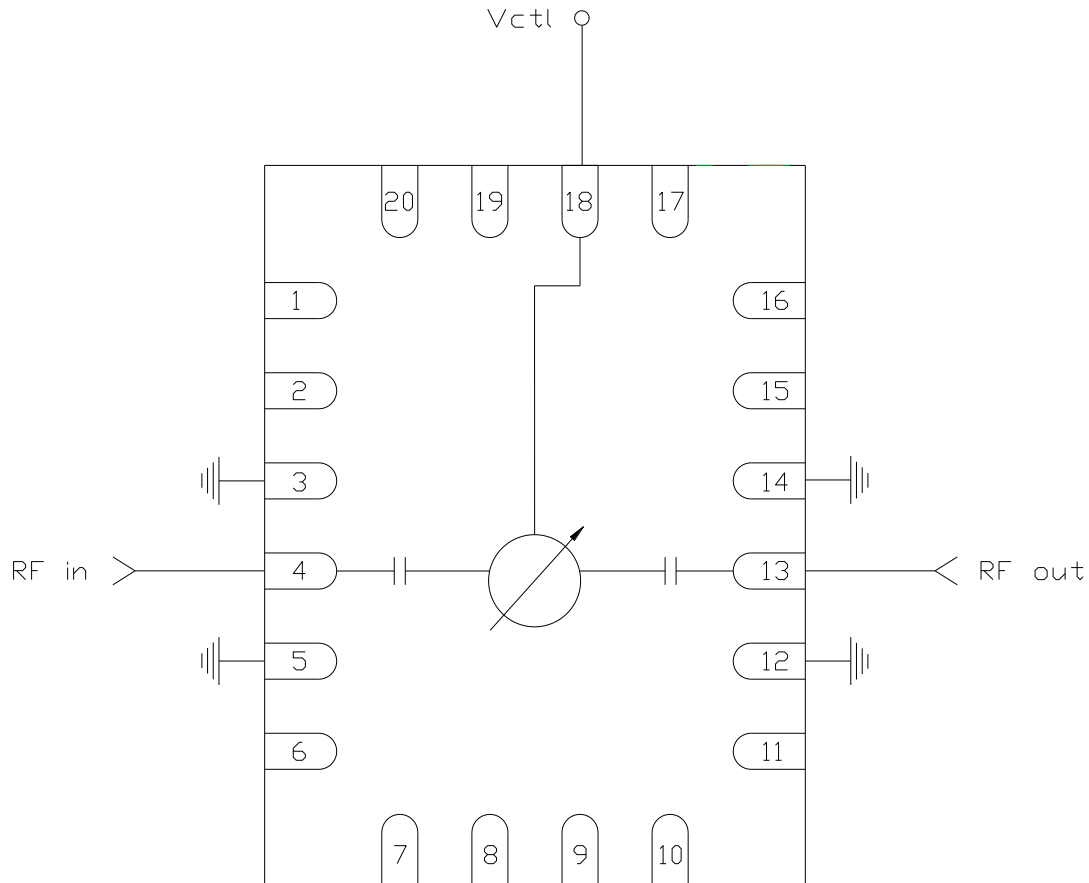

Biasing and Operation

The CMD297P34 has a single control voltage (V_{ctrl}). Full phase shift range is achieved when V_{ctrl} is varied from 0 to +10 V.

RF power can be applied at any time.

GaAs MMIC devices are susceptible to damage from Electrostatic Discharge. Proper precautions should be observed during handling, assembly and test.

Applications Information

Evaluation Board

The circuit board shown has been developed for optimized assembly at Qorvo. A sufficient number of via holes should be used to connect the top and bottom ground planes. As surface mount processes vary, careful process development is recommended.

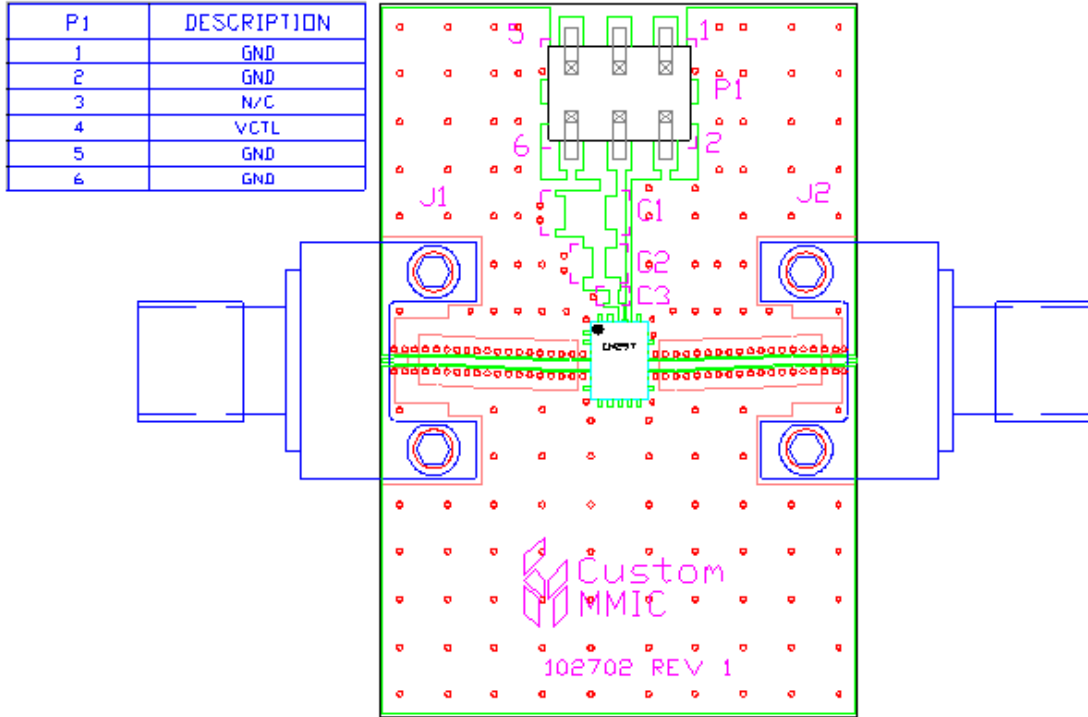

Bill of Material

Designator	Value	Description
J1, J2		SMA End Launch Connector
P1		6 Pin Header
U1		CMD297P34 Analog Phase Shifter
C1	0.33 μ F	CAP, 20%, 35V, TANT, 1206
C2	1000 pF	CAP, +/-10%, 50V, X7R, 0603
C3	100 pF	CAP, 5%, 25V, COG, 0402
PCB		102702 Evaluation PCB

Handling Precautions

Parameter	Rating	Standard
ESD – Human Body Model (HBM)	Class 1A	ESDA / JEDEC JS-001-2012
MSL – Moisture Sensitivity Level	Level 1	JEDEC standard IPC/JEDEC J-STD-020



Caution!
ESD-Sensitive Device

RoHS Compliance

This part is compliant with 2011/65/EU RoHS directive (Restrictions on the Use of Certain Hazardous Substances in Electrical and Electronic Equipment) as amended by Directive 2015/863/EU.

This product also has the following attributes:

- Lead Free
- Antimony Free
- TBBP-A (C₁₅H₁₂Br₄O₂) Free
- SVHC Free
- Halogen Free
- PFOS Free

Contact Information

For the latest specifications, additional product information, worldwide sales and distribution locations:

Web: www.qorvo.com

Tel: 1-844-890-8163

Email: customer.support@qorvo.com

Important Notice

The information contained in this Data Sheet and any associated documents (“Data Sheet Information”) is believed to be reliable; however, Qorvo makes no warranties regarding the Data Sheet Information and assumes no responsibility or liability whatsoever for the use of said information. All Data Sheet Information is subject to change without notice. Customers should obtain and verify the latest relevant Data Sheet Information before placing orders for Qorvo® products. Data Sheet Information or the use thereof does not grant, explicitly, implicitly or otherwise any rights or licenses to any third party with respect to patents or any other intellectual property whether with regard to such Data Sheet Information itself or anything described by such information.

DATA SHEET INFORMATION DOES NOT CONSTITUTE A WARRANTY WITH RESPECT TO THE PRODUCTS DESCRIBED HEREIN, AND QORVO HEREBY DISCLAIMS ANY AND ALL WARRANTIES WITH RESPECT TO SUCH PRODUCTS WHETHER EXPRESS OR IMPLIED BY LAW, COURSE OF DEALING, COURSE OF PERFORMANCE, USAGE OF TRADE OR OTHERWISE, INCLUDING THE IMPLIED WARRANTIES OF MERCHANTABILITY AND FITNESS FOR A PARTICULAR PURPOSE. Without limiting the generality of the foregoing, Qorvo® products are not warranted or authorized for use as critical components in medical, life-saving, or life-sustaining applications, or other applications where a failure would reasonably be expected to cause severe personal injury or death. Applications described in the Data Sheet Information are for illustrative purposes only. Customers are responsible for validating that a particular product described in the Data Sheet Information is suitable for use in a particular application.

© 2023 Qorvo US, Inc. All rights reserved. This document is subject to copyright laws in various jurisdictions worldwide and may not be reproduced or distributed, in whole or in part, without the express written consent of Qorvo US, Inc. | QORVO® is a registered trademark of Qorvo US, Inc.