

Americas

147 Central Avenue
 Hackensack, NJ 07601
 (201) 489-8989
www.cml-it.com

Europe

Robert Bunsen Str. 1
 D-67098 Bad Durkheim
 +49 (6322) 9567-0
www.cml-it.com

CMDA42xx15D13L Series Power LED (1watt) Technical Datasheet



CMDA42 Power series is designed for high current operation and high flux output applications. Its thermal management characteristic are better than other LED solutions due to the SMD package design and good thermal emission material.

With these design advantages, it enables the Power LED to be applied in various lighting applications and design solution, automotive, architectural lighting, and large size LCD backlight etc.

Features

- Super high Flux output and high Luminance
- Designed for high current operation
- Low thermal resistance
- SMT solderability
- Lead Free product
- RoHS compliant

Application

- Mobile phone flash
- Automotive interior / exterior lighting
- Automotive signal lighting
- Automotive forward lighting
- General Lighting (Torch)
- Architectural lighting
- LCD TV / Monitor Backlight
- Projector light source
- Traffic Signals
- Task lighting
- Decorative / Pathway lighting
- Remote / Solar powered lighting
- Household appliances

1. Outline Dimensions

Dome Type

TOP VIEW

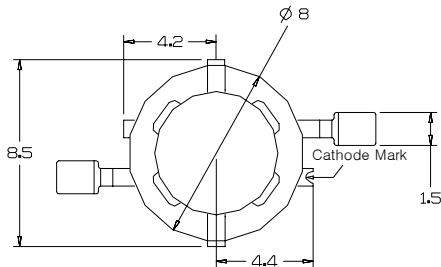

BOTTOM VIEW

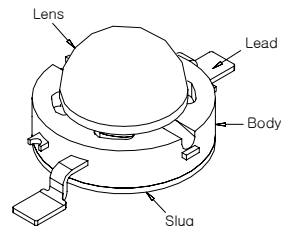
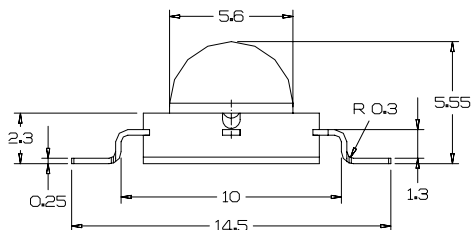
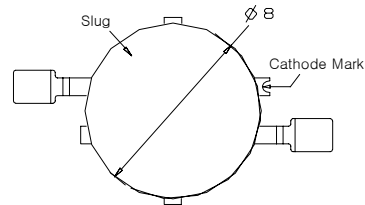

Notes :

1. All dimensions are in millimeters.
2. Scale : none
3. This drawing without tolerances are for reference only
4. Slug of package is connected to anode.



Americas
147 Central Avenue
Hackensack, NJ 07601
(201) 489-8989
www.cml-it.com

Europe
Robert Bunsen Str. 1
D-67098 Bad Dürkheim
+49 (6322) 9567-0
www.cml-it.com

Americas

147 Central Avenue
 Hackensack, NJ 07601
 (201) 489-8989
www.cml-it.com

Europe

Robert Bunsen Str. 1
 D-67098 Bad Durkheim
 +49 (6322) 9567-0
www.cml-it.com

2. Electro-Optical Characteristics (at IF=350mA, TA=25°C)

P/N	Description	Luminous Flux Min./Typ. (lm)	Correlated Color Temperature (Kelvin)	CRI	Dominant Wavelength (nm) Min./Typ./Max.	Forward Voltage (volts) Min./Typ./Max.	View Angle (degrees)	Thermal resistance (°C /W)
	Symbol	ΦV [1]	CCT [3]	Ra	λD	V	2θ 1/2	Rθ [4]
CMDA42CW15D13L	Pure White	32 / 52	6500	76		3.0 / 3.4 / 4.3	120	16
CMDA42WW15D13L	Warm White	24 / 35	3000	76		3.0 / 3.4 / 4.3	120	16
CMDA42CB15D13L	Blue	6 / 11			455 / 460 / 475	3.0 / 3.4 / 4.3	130	16
CMDA42AG15D13L	Green	24 / 48			520 / 527 / 535	3.0 / 3.4 / 4.3	130	16
CMDA42AR15D13L	Red	24 / 30			620 / 625 / 630	2.0 / 2.5 / 3.0	128	19
CMDA42GB15D13L	Cyan	24 / 40			500 / 505 / 510	3.0 / 3.4 / 4.3	130	16
CMDA42DY15D13L	Amber	24 / 38			585 / 590 / 595	2.0 / 2.5 / 3.0	128	19

3. Absolute Maximum Ratings (at TA=25°C)

P/N	Description	Forward Current (A)	Power Dissipation (Watts)	Junction Temperat ure (°C)	Operating Temperature (°C)	Storage Temperature (°C)
	Symbol	I _F	P _D	T _J	T _{opr}	T _{stg}
CMDA42CW15D13L	Pure White	0.4	1.6	125	-30~+85	-40~+120
CMDA42WW15D13L	Warm White	0.4	1.6	125	-30~+85	-40~+120
CMDA42CB15D13L	Blue	0.4	1.6	125	-30~+85	-40~+120
CMDA42AG15D13L	Green	0.4	1.6	125	-30~+85	-40~+120
CMDA42AR15D13L	Red	0.4	1.2	100	-30~+85	-40~+120
CMDA42GB15D13L	Cyan	0.4	1.6	125	-30~+85	-40~+120
CMDA42DY15D13L	Amber	0.4	1.2	100	-30~+85	-40~+120

***Notes:**

- [1] ΦV is the total luminous flux output as measured with an integrating sphere.
- [2] Zener diode chip included to protect the LED from ESD.
- [3] Rθ is measured with a metal core PCB (25 °C ≤ T_J ≤ 125 °C).
- [4] CML maintains a tolerance of ± 10% on flux and power measurements.
- [5] CCT ± 5% tester tolerance.
- [6] Color Coordinate Measurement allowance is ± 0.005
- [7] A tolerance of ± 0.006V on forward voltage measurements

-----Caution-----

Please do not drive at rated current more than 5 sec. without proper heat sink

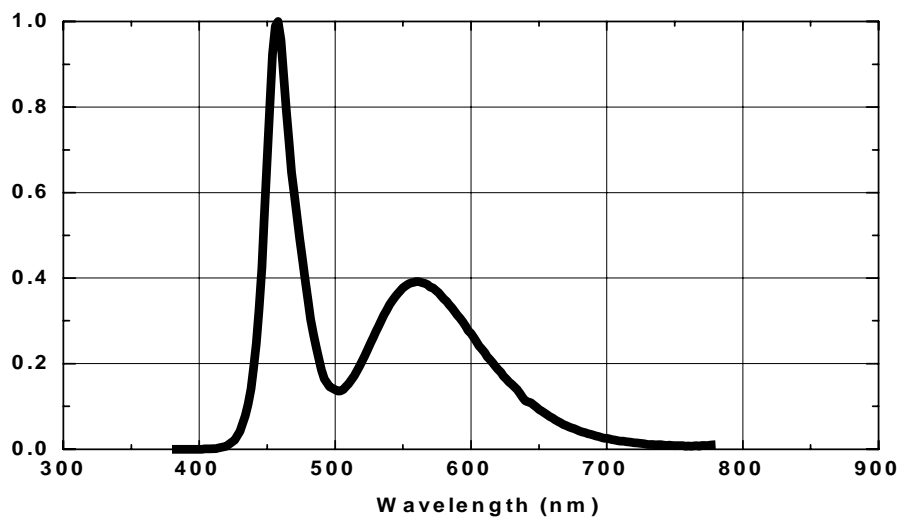
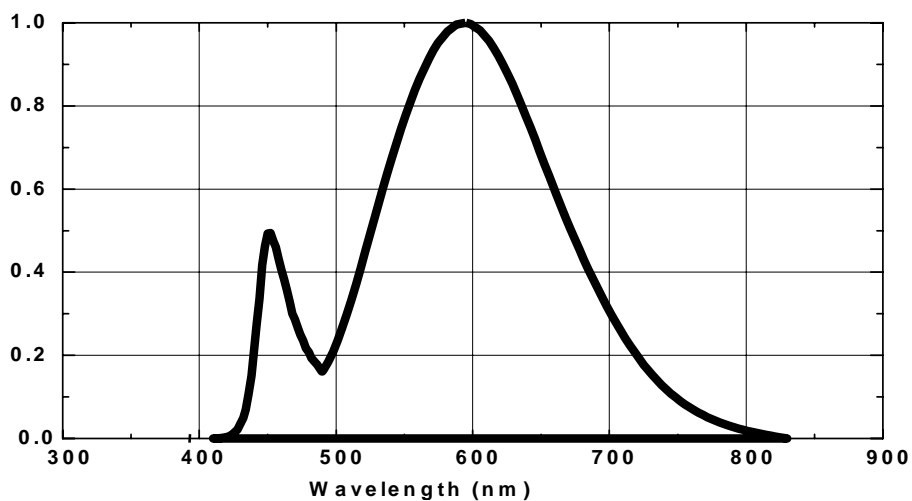
White color spectrum, $T_A=25^\circ\text{C}$ **1. Pure White****2. Warm White**

Americas
147 Central Avenue
Hackensack, NJ 07601
(201) 489-8989
www.cml-it.com

Europe
Robert Bunsen Str. 1
D-67098 Bad Durkheim
+49 (6322) 9567-0
www.cml-it.com

3. Blue, Cyan, Green, Amber, Red

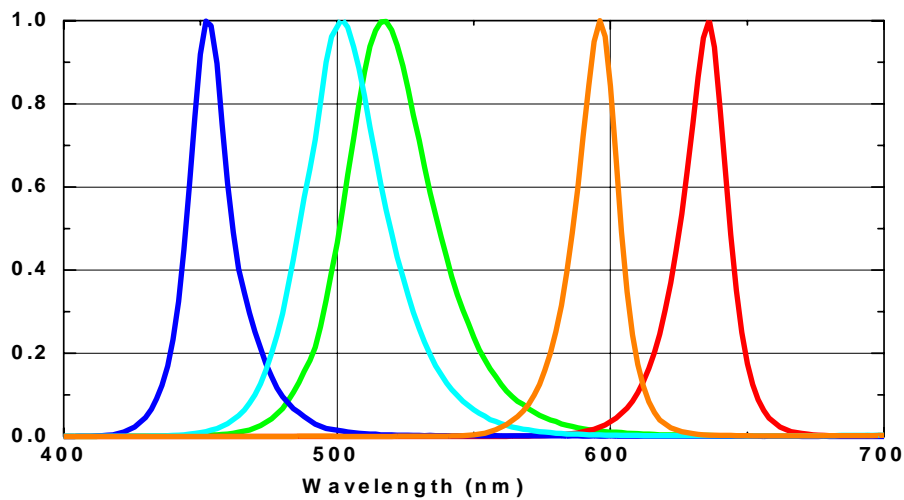

Americas
147 Central Avenue
Hackensack, NJ 07601
(201) 489-8989
www.cml-it.com

Europe
Robert Bunsen Str. 1
D-67098 Bad Durkheim
+49 (6322) 9567-0
www.cml-it.com

Light Output Characteristics

1. Relative Light Output vs. Junction Temperature at $I_F=350\text{mA}$, $T_A=25^\circ\text{C}$

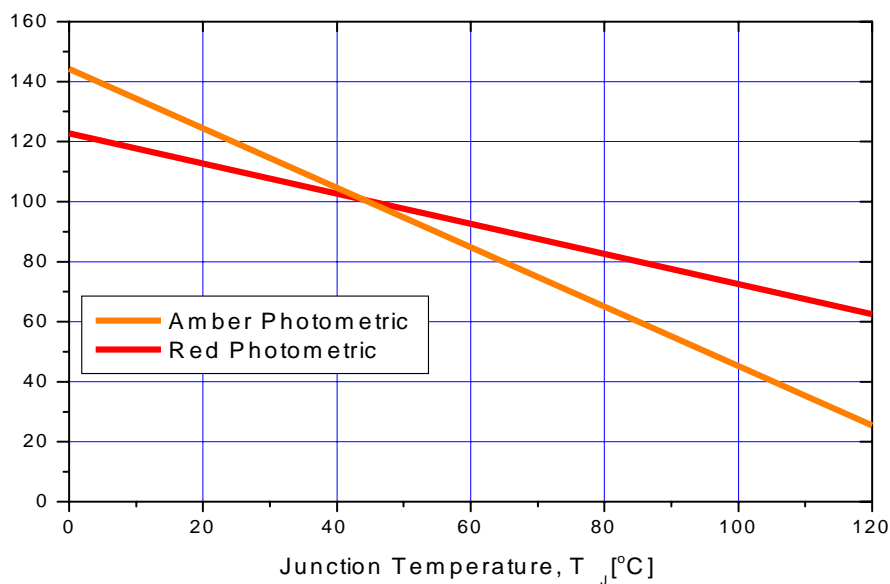
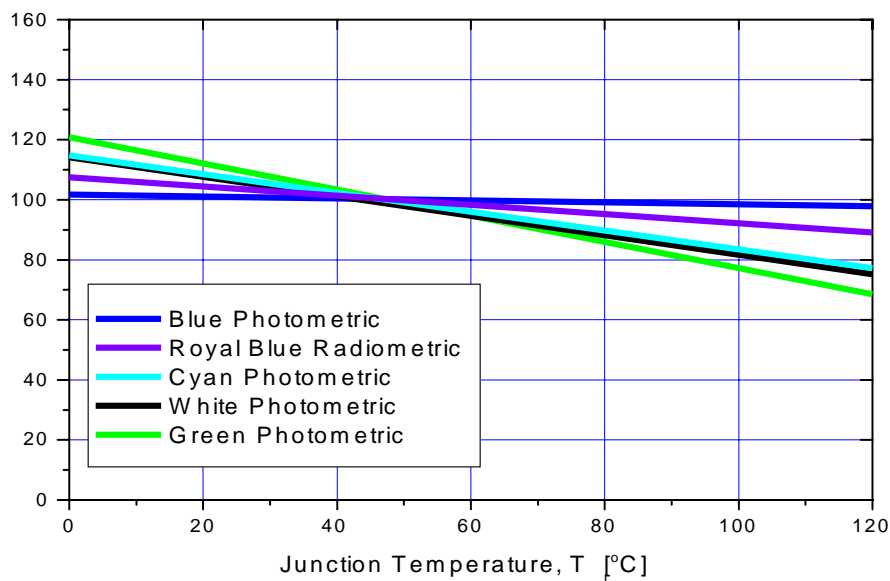

Forward Current Characteristics

1. Forward Voltage vs. Forward Current, $T_A=25^\circ\text{C}$

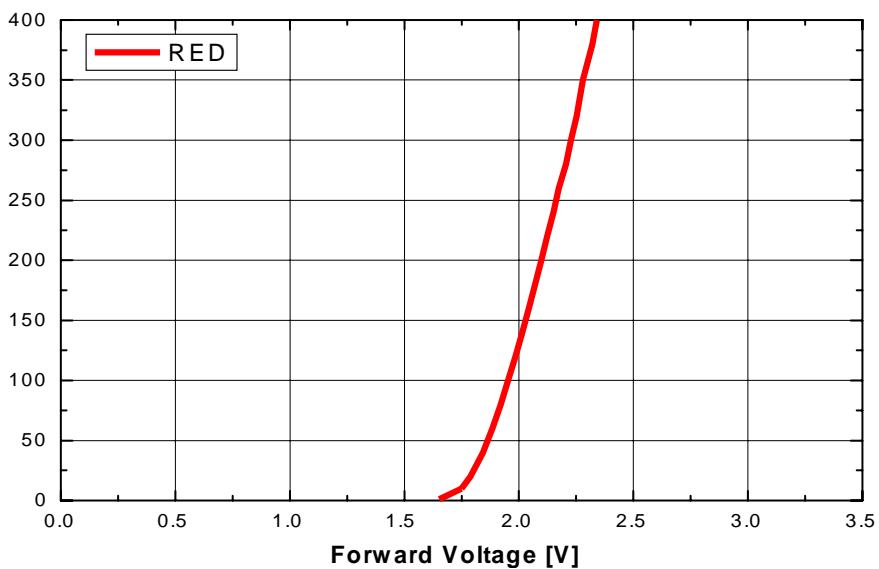
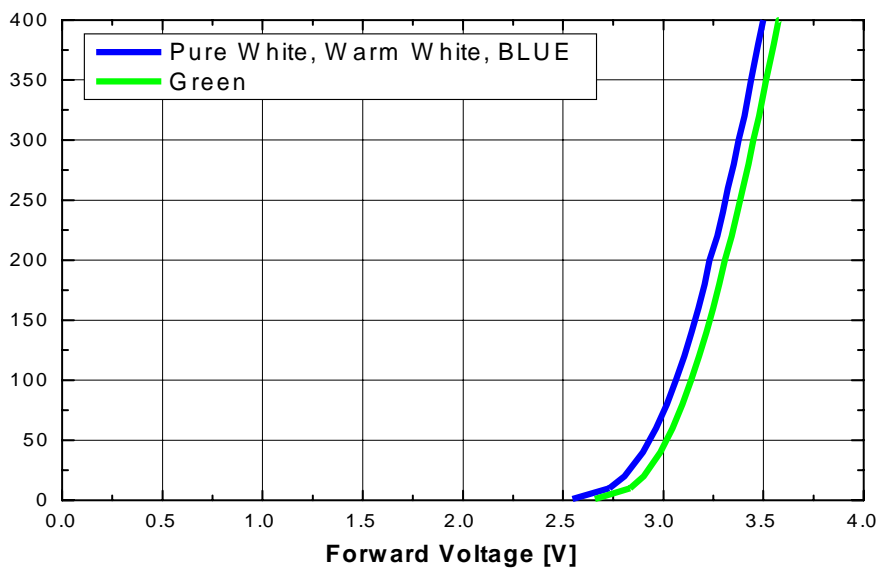

2. Forward Current vs. Normalized Relative Luminous Flux, $T_A=25^\circ\text{C}$

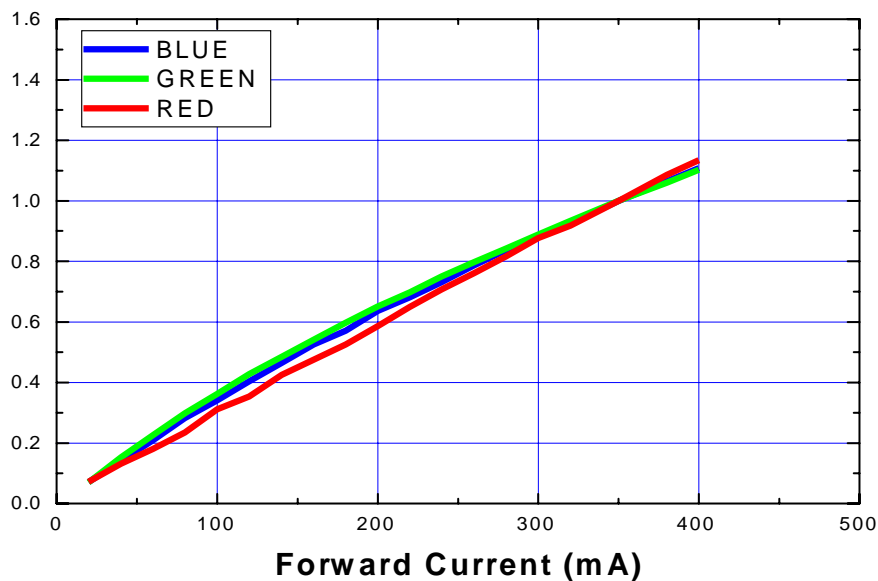

3. Forward Current vs. Wavelength shift, $T_A=25^\circ\text{C}$

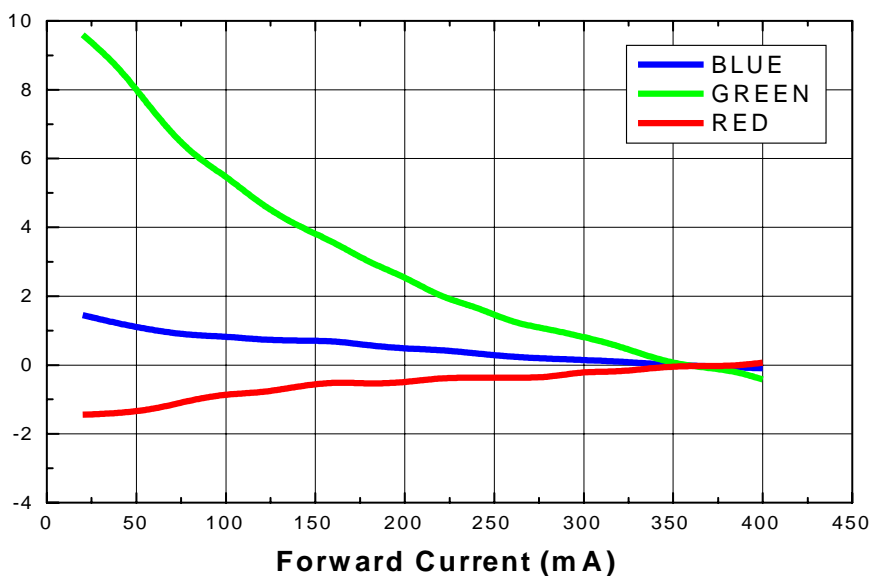

Ambient Temperature vs. Allowable Forward Current

1. Pure White, Warm White, Royal Blue, Blue, Cyan, Green ($T_{JMAX} = 125\text{ }^{\circ}\text{C}$)

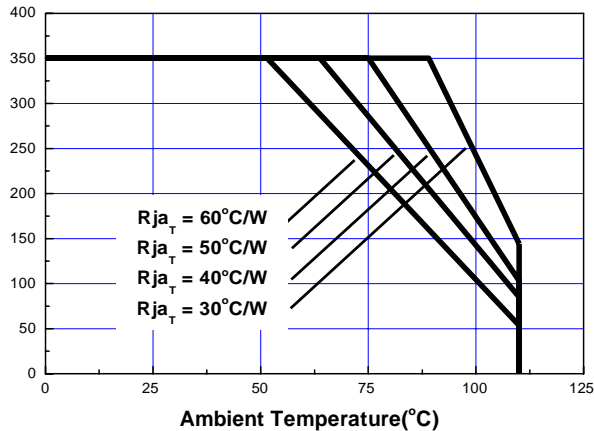

2. Amber, Red ($T_{JMAX} = 100\text{ }^{\circ}\text{C}$)

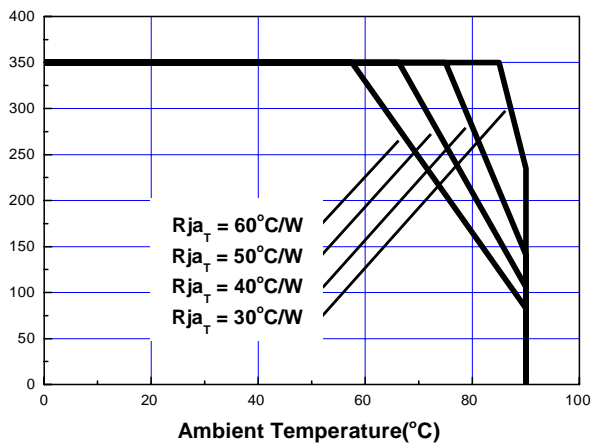

Americas
147 Central Avenue
Hackensack, NJ 07601
(201) 489-8989
www.cml-it.com

Europe
Robert Bunsen Str. 1
D-67098 Bad Durkheim
+49 (6322) 9567-0
www.cml-it.com

Typical Dome Type Radiation pattern

1. Pure White, Warm White

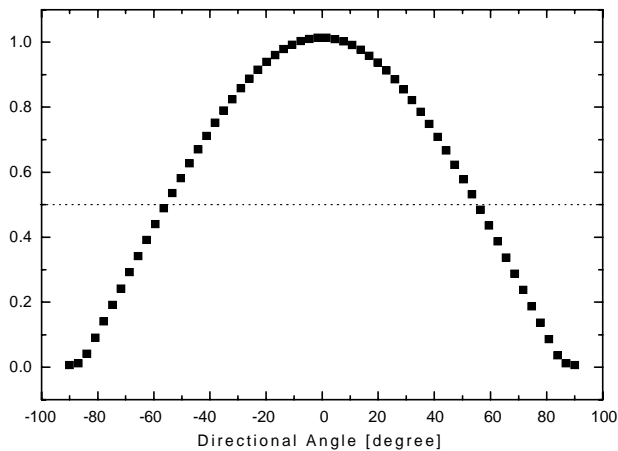

2. Royal Blue, Blue, Cyan, Green

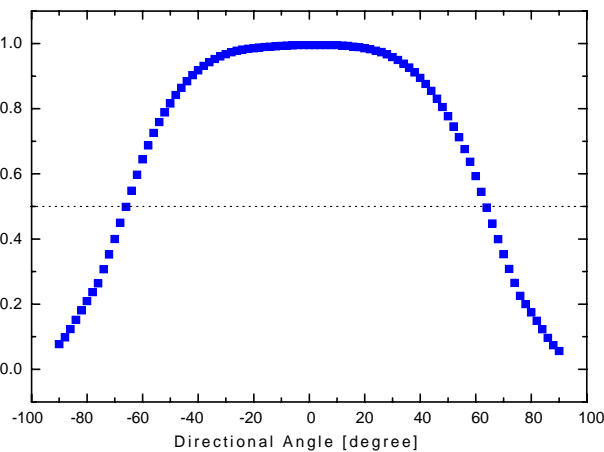

3. Amber, Red

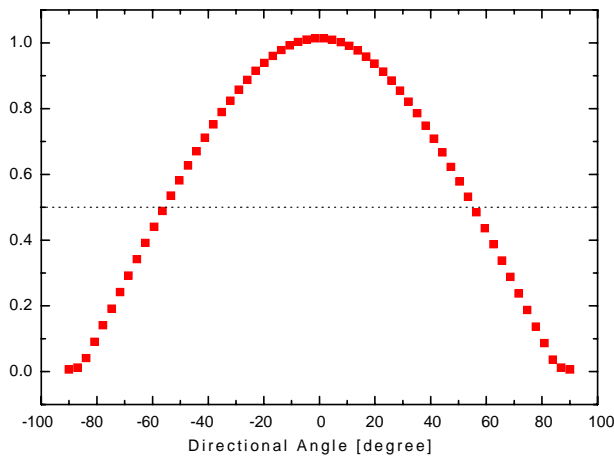

Recommended Solder pad

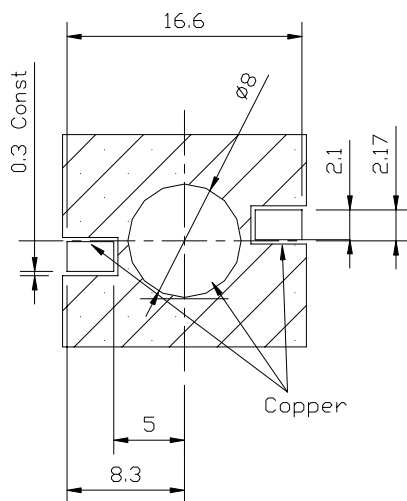
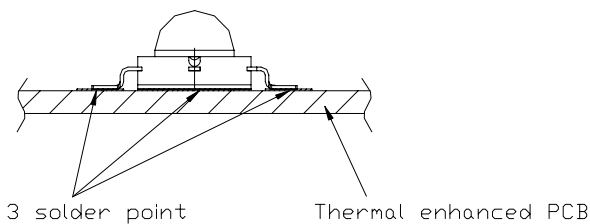

<Footprint & Solder pad>

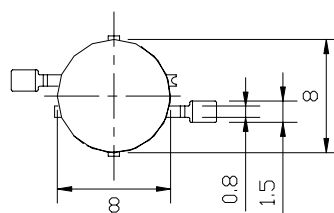

<Rear view>

Note :

1. All dimensions are in millimeters
2. Scale none
3. This drawing without tolerances are for reference only



Americas
147 Central Avenue
Hackensack, NJ 07601
(201) 489-8989
www.cml-it.com

Europe
Robert Bunsen Str. 1
D-67098 Bad Durkheim
+49 (6322) 9567-0
www.cml-it.com

Emitter Reel Packaging

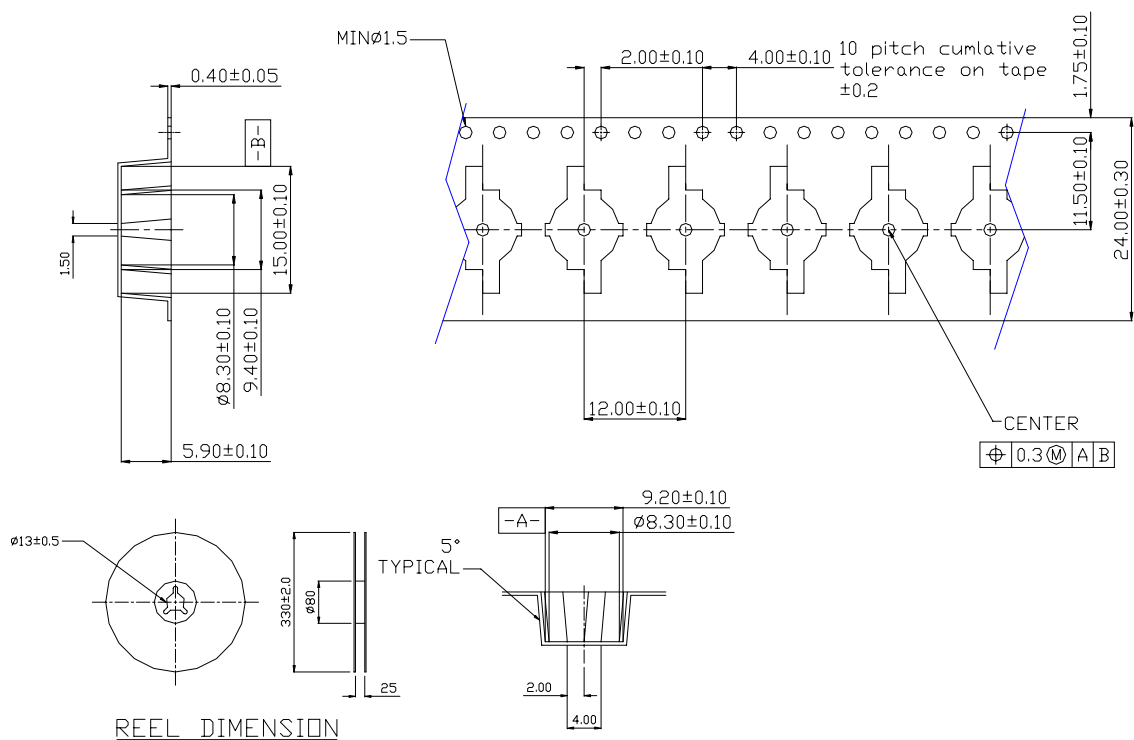

Note :

1. The number of loaded products in the reel is 750ea
2. All dimensions are in millimeters
3. Scale none
4. This drawing without tolerances are for reference only



Americas
147 Central Avenue
Hackensack, NJ 07601
(201) 489-8989
www.cml-it.com

Europe
Robert Bunsen Str. 1
D-67098 Bad Durkheim
+49 (6322) 9567-0
www.cml-it.com

Soldering profile, $T_A = 25^\circ\text{C}$

1. Reflow Soldering Conditions / Profile

Preliminary heating to be at 180°C max. for 2 minutes max. Soldering heat to be at 260°C max. for 5 seconds max.

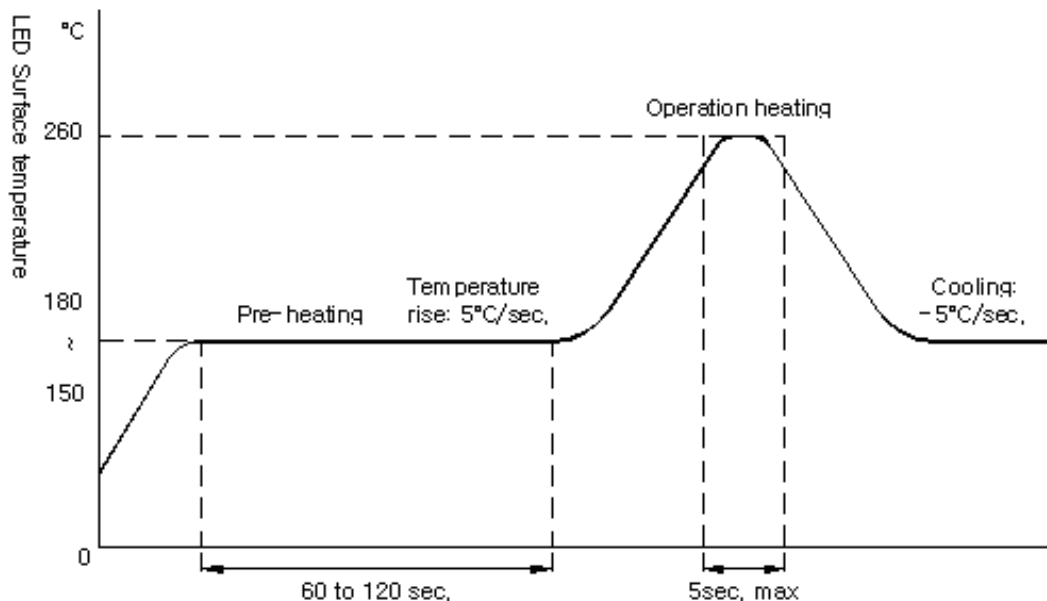

2. Hand Soldering conditions

Lead : Not more than 3 seconds @MAX 280°C
 Slug : Use a thermal-adhesives

* Caution

No second soldering recommended



Americas
 147 Central Avenue
 Hackensack, NJ 07601
 (201) 489-8989
www.cml-it.com

Europe
 Robert Bunsen Str. 1
 D-67098 Bad Dürkheim
 +49 (6322) 9567-0
www.cml-it.com