

**CML****INNOVATIVE TECHNOLOGIES, INC.****WHERE INNOVATION COMES TO LIGHT**Americas

147 Central Avenue
Hackensack, NJ 07601
(201) 489-8989
www.cml-it.com

Europe

Robert Bunsen Str. 1
D-67098 Bad Durkheim
+49 (6322) 9567-0
www.cml-it.com

CMDA52xx15D13L Series Power LED (5 Watt) on Star PCB
CMDA53xx15D13L Series Power LED (5 Watt) on Square PCB

- Features

- Super high flux output and high luminance
- Designed for high current operation
- Low thermal resistance
- SMT solder compatible
- Lead (Pb) Free Product – RoHS Compliant

- Applications

- General Illumination
 - Outdoor & Indoor Architectural Lighting
 - Decorative Lighting
 - Portable Lighting / Flash Light (Torch) Lamps
 - Reading Lamps and Task Lighting
 - Traffic Signaling

- Description

These packaged LED's on metal PCB's are designed for high current operation and high flux output applications. The package design features better thermal management characteristics than other LED solutions. Because of these advantages, this product has many applications such as internal & external lighting, automobile lighting, large size LCD backlight, etc.

Americas

147 Central Avenue
 Hackensack, NJ 07601
 (201) 489-8989
www.cml-it.com

Europe

Robert Bunsen Str. 1
 D-67098 Bad Durkheim
 +49 (6322) 9567-0
www.cml-it.com

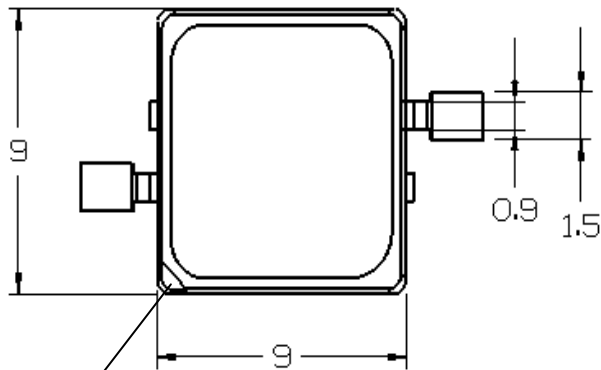
1. Outline Dimensions

Cathode
 Mark

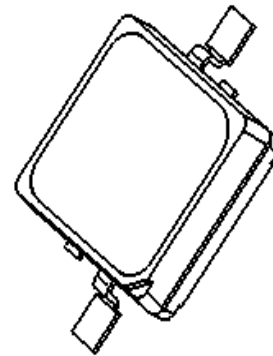
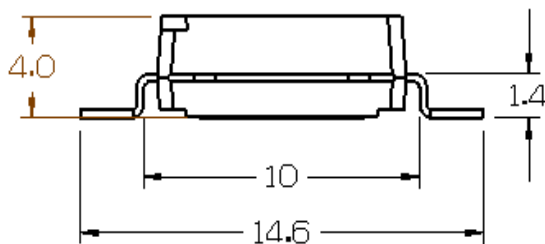

Isometric view
 Scale: None

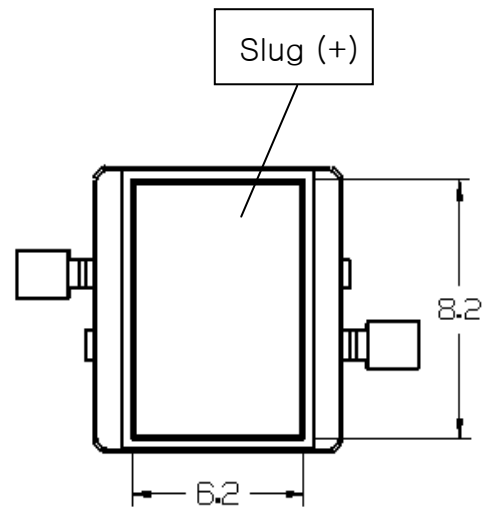

Rear view

- Notes : 1. All dimensions are in millimeters.
 2. Scale : none
 3. This drawing is reference only for engineering

2. Metal Outline Dimensions

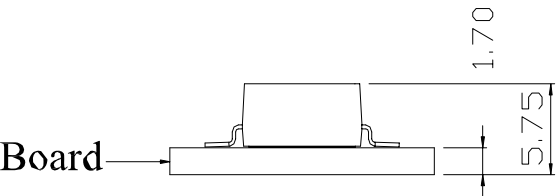
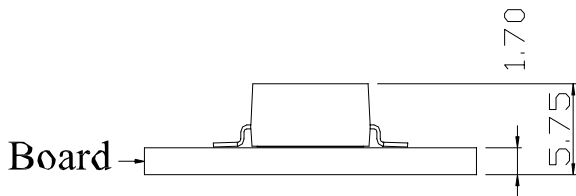
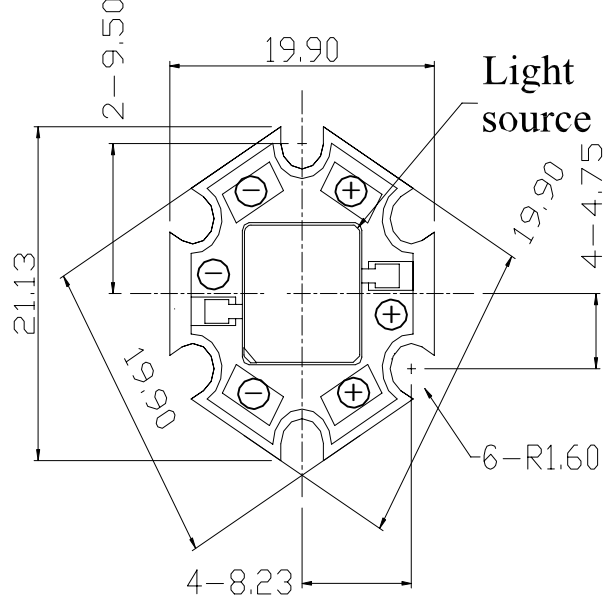
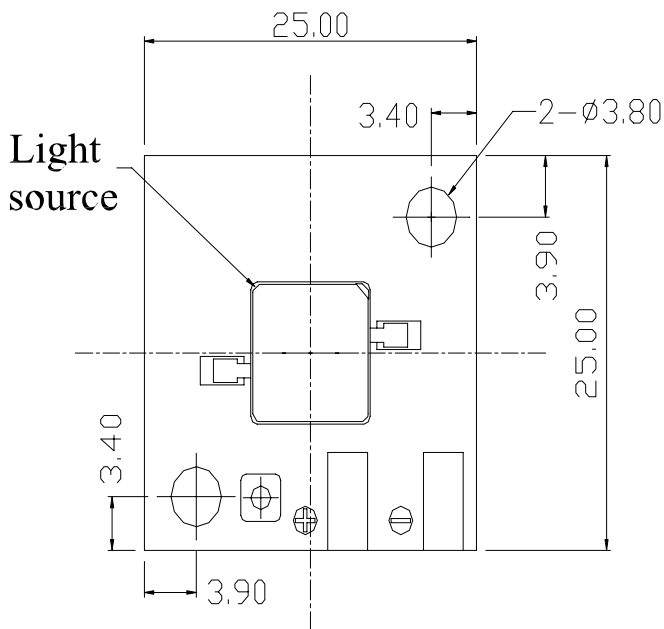

**CMDA53xx15D13L
Square Configuration**

**CMDA52xx15D13L
Star Configuration**

- Note : 1. All dimensions are in millimeters
 2. Scale : none
 3. This drawing is reference only engineering.



Americas
 147 Central Avenue
 Hackensack, NJ 07601
 (201) 489-8989
www.cml-it.com

Europe
 Robert Bunsen Str. 1
 D-67098 Bad Durkheim
 +49 (6322) 9567-0
www.cml-it.com

Americas

147 Central Avenue
 Hackensack, NJ 07601
 (201) 489-8989
www.cml-it.com

Europe

Robert Bunsen Str. 1
 D-67098 Bad Durkheim
 +49 (6322) 9567-0
www.cml-it.com

3. Electro-Optical Characteristics (at IF=350mA, TA=25°C)**CMDA52xx15D13L Star PCB series**

P/N	Description	Luminous Flux Min./Typ. (lm)	Correlated Color Temperature (Kelvin)	CRI	Dominant Wavelength (nm) Min./Typ./Max.	Forward Voltage (volts) Min./Typ./Max.	View Angle (degrees)	Thermal resistance (°C /W)
	Symbol	ΦV [1]	CCT [3]	Ra	λD	V	2Θ 1/2	Rθ [4]
CMDA52CW15D13L	Pure White	154 / 178	6500	70		3.0 / 3.5 / 4.0	110	4
CMDA52WW15D13L	Warm White	91 / 120	3000	80		3.0 / 3.5 / 4.0	110	4
CMDA52CB15D13L	Blue	24 / 30			455 / 460 / 475	3.0 / 3.5 / 4.0	130	4
CMDA52AG15D13L	Green	118 / 189			520 / 527 / 535	3.0 / 3.5 / 4.0	130	4
CMDA52AR15D13L	Red	91 / 114			620 / 625 / 630	2.0 / 2.5 / 3.0	128	6
CMDA52GB15D13L	Cyan	118 / 150			500 / 505 / 510	3.0 / 3.5 / 4.0	130	4
CMDA52DY15D13L	Amber	118 / 144			585 / 590 / 595	2.0 / 2.5 / 3.0	128	6

4. Absolute Maximum Ratings (at TA=25°C)

P/N	Description	Forward Current (A)	Power Dissipation (Watts)	Junction Temperature (°C)	Operating Temperature (°C)	Storage Temperature (°C)
	Symbol	IF	PD	Tj	Topr	Tstg
CMDA52CW15D13L	Pure White	1.6	6.4	125	-30~+85	-40~+120
CMDA52WW15D13L	Warm White	1.6	6.4	125	-30~+85	-40~+120
CMDA52CB15D13L	Blue	1.6	6.4	125	-30~+85	-40~+120
CMDA52AG15D13L	Green	1.6	6.4	125	-30~+85	-40~+120
CMDA52AR15D13L	Red	1.6	4.8	100	-30~+85	-40~+120
CMDA52GB15D13L	Cyan	1.6	6.4	125	-30~+85	-40~+120
CMDA52DY15D13L	Amber	1.6	4.8	100	-30~+85	-40~+120

***Notes:**

[1] ΦV is the total luminous flux output as measured with an integrating sphere.

[2] Zener diode chip included to protect the LED from ESD.

[3] Rθ is measured with a metal core PCB (25 °C ≤ TJ ≤ 125 °C).

[4] CML maintains a tolerance of ± 10% on flux and power measurements.

[5] CCT ± 5% tester tolerance.

[6] Color Coordinate Measurement allowance is ± 0.005

[7] A tolerance of ± 0.006V on forward voltage measurements

-----**Caution**-----

Please do not drive at rated current more than 5 sec. without proper heat sink

Americas

147 Central Avenue
 Hackensack, NJ 07601
 (201) 489-8989
www.cml-it.com

Europe

Robert Bunsen Str. 1
 D-67098 Bad Durkheim
 +49 (6322) 9567-0
www.cml-it.com

5. Electro-Optical Characteristics (at IF=350mA, TA=25°C)**CMDA53xx15D13L Square PCB series**

P/N	Description	Luminous Flux Min./Typ. (lm)	Correlated Color Temperature (Kelvin)	CRI	Dominant Wavelength (nm) Min./Typ./Max.	Forward Voltage (volts) Min./Typ./Max.	View Angle (degrees)	Thermal resistance (°C /W)
	Symbol	ΦV [1]	CCT [3]	Ra	λD	V	2θ 1/2	Rθ [4]
CMDA53CW15D13L	Pure White	154 / 178	6500	70		3.0 / 3.5 / 4.0	110	4
CMDA53WW15D13L	Warm White	91 / 120	3000	80		3.0 / 3.5 / 4.0	110	4
CMDA53CB15D13L	Blue	24 / 30			455 / 460 / 475	3.0 / 3.5 / 4.0	130	4
CMDA53AG15D13L	Green	118 / 189			520 / 527 / 535	3.0 / 3.5 / 4.0	130	4
CMDA53AR15D13L	Red	91 / 114			620 / 625 / 630	2.0 / 2.5 / 3.0	128	6
CMDA53GB15D13L	Cyan	118 / 150			500 / 505 / 510	3.0 / 3.5 / 4.0	130	4
CMDA53DY15D13L	Amber	118 / 144			585 / 590 / 595	2.0 / 2.5 / 3.0	128	6

6. Absolute Maximum Ratings (at TA=25°C)

P/N	Description	Forward Current (A)	Power Dissipation (Watts)	Junction Temperat ure (°C)	Operating Temperature (°C)	Storage Temperature (°C)
	Symbol	I _F	P _D	T _J	T _{opr}	T _{stg}
CMDA53CW15D13L	Pure White	1.6	6.4	125	-30~+85	-40~+120
CMDA53WW15D13L	Warm White	1.6	6.4	125	-30~+85	-40~+120
CMDA53CB15D13L	Blue	1.6	6.4	125	-30~+85	-40~+120
CMDA53AG15D13L	Green	1.6	6.4	125	-30~+85	-40~+120
CMDA53AR15D13L	Red	1.6	4.8	100	-30~+85	-40~+120
CMDA53GB15D13L	Cyan	1.6	6.4	125	-30~+85	-40~+120
CMDA53DY15D13L	Amber	1.6	4.8	100	-30~+85	-40~+120

***Notes:**

[1] ΦV is the total luminous flux output as measured with an integrating sphere.

[2] Zener diode chip included to protect the LED from ESD.

[3] Rθ is measured with a metal core PCB (25 °C ≤ T_J ≤ 125 °C).

[4] CML maintains a tolerance of ± 10% on flux and power measurements.

[5] CCT ± 5% tester tolerance.

[6] Color Coordinate Measurement allowance is ± 0.005

[7] A tolerance of ± 0.006V on forward voltage measurements

-----Caution-----

Please do not drive at rated current more than 5 sec. without proper heat sink

7. Forward Voltage vs. Forward Current ($T_a=25^\circ\text{C}$)

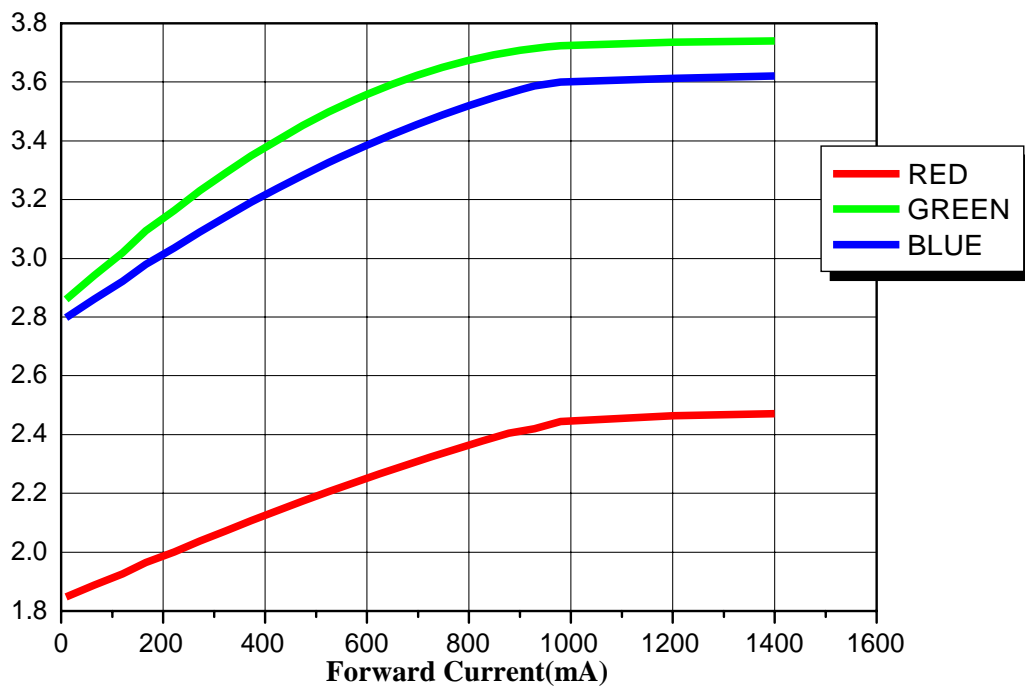

8. Forward Current vs. Normalized Relative Luminous Flux ($T_a=25^\circ\text{C}$)

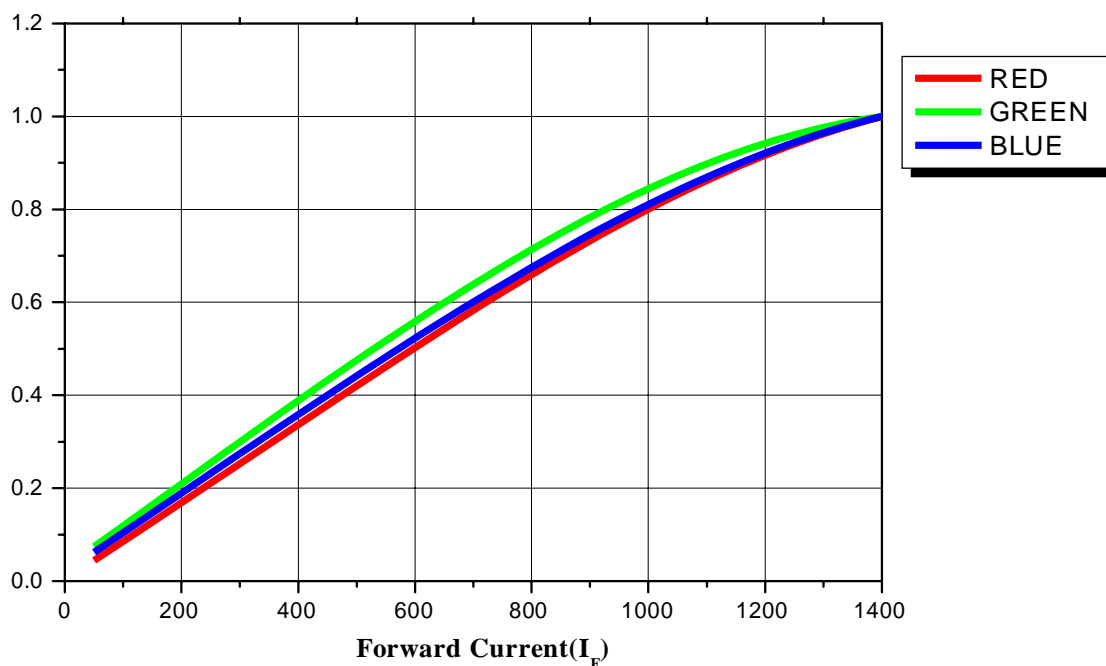

9. White Color spectrum of Typical CCT ($T_a=25^\circ\text{C}$)

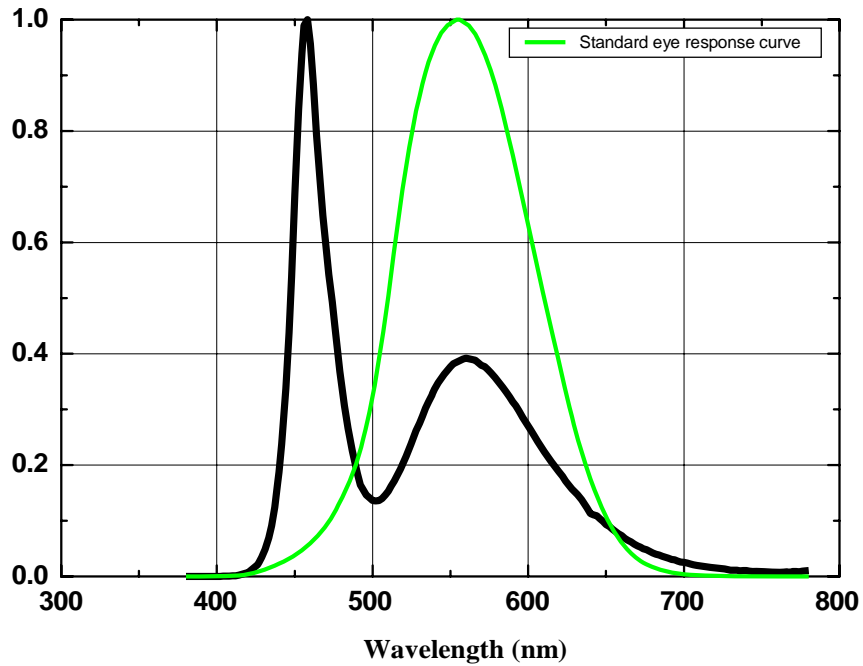

10. Warm White spectrum of Typical CCT

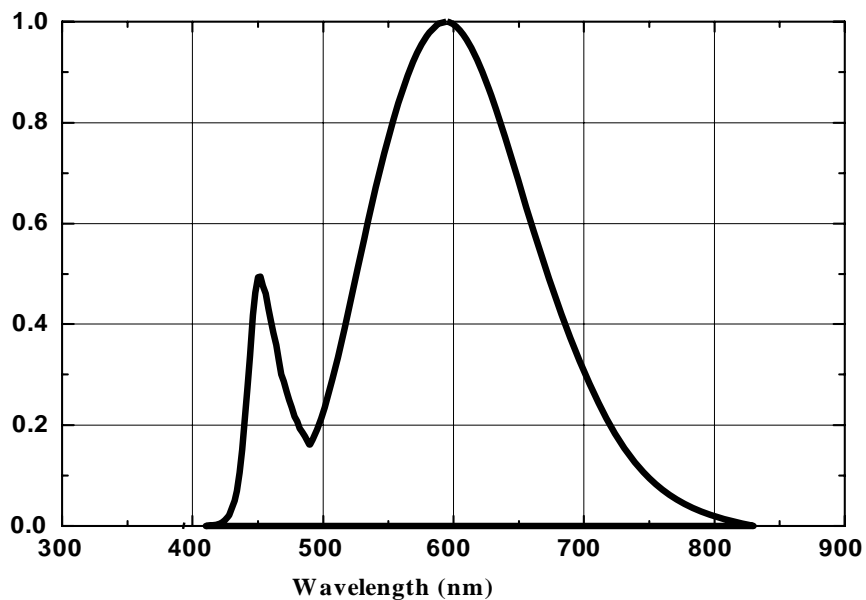

Americas
147 Central Avenue
Hackensack, NJ 07601
(201) 489-8989
www.cml-it.com

Europe
Robert Bunsen Str. 1
D-67098 Bad Durkheim
+49 (6322) 9567-0 www.DataSheet4U.com
www.cml-it.com

11. Spectrum for Red, Green, Blue, Amber, Cyan

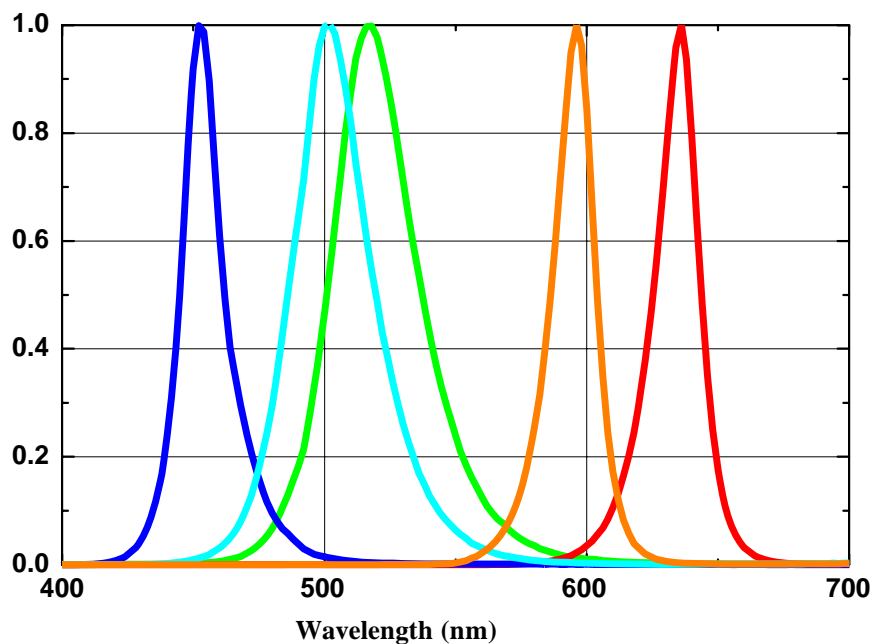

Americas
147 Central Avenue
Hackensack, NJ 07601
(201) 489-8989
www.cml-it.com

Europe
Robert Bunsen Str. 1
D-67098 Bad Dürkheim
+49 (6322) 9567-0
www.cml-it.com

www.DataSheet4U.com

12. Radiation pattern for

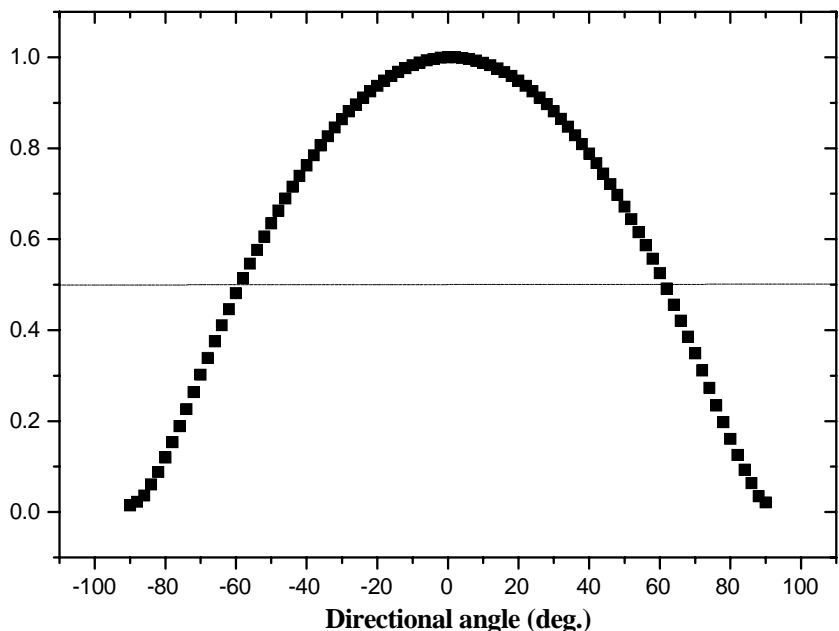

13. Radiation pattern for Red

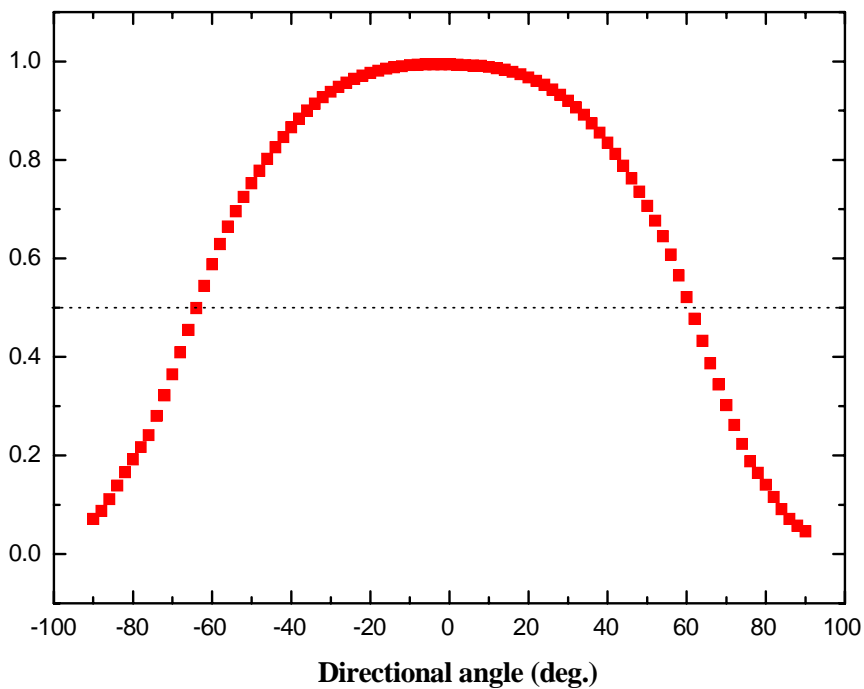

Americas
 147 Central Avenue
 Hackensack, NJ 07601
 (201) 489-8989
www.cml-it.com

Europe
 Robert Bunsen Str. 1
 D-67098 Bad Dürkheim
 +49 (6322) 9567-0
www.cml-it.com

14. Radiation pattern for Green

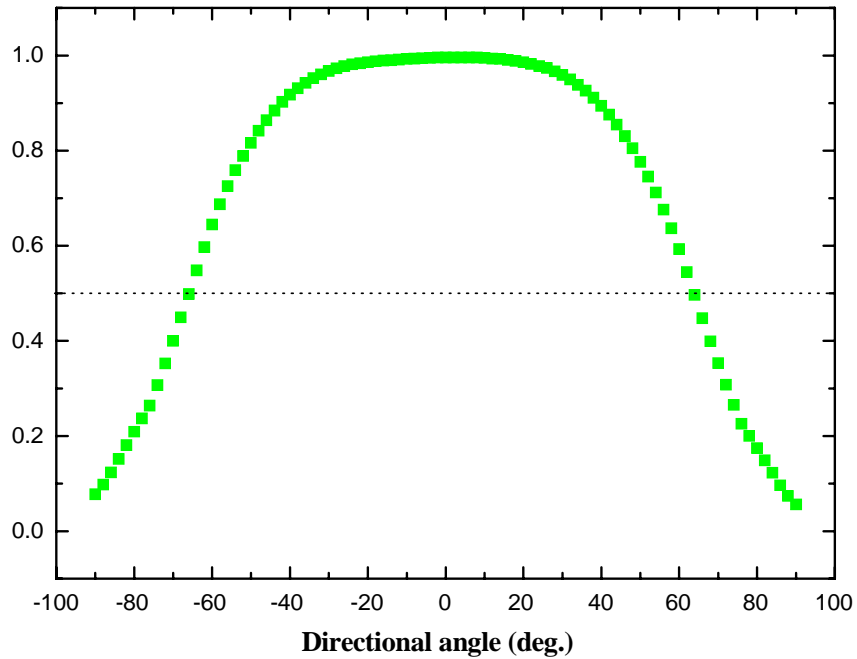

15. Radiation pattern for Blue

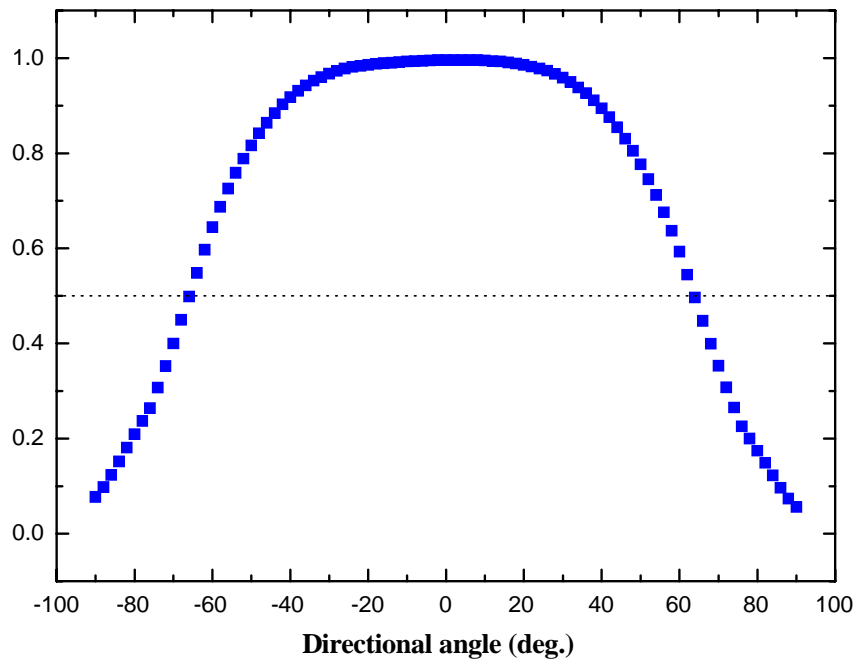

Americas
147 Central Avenue
Hackensack, NJ 07601
(201) 489-8989
www.cml-it.com

Europe
Robert Bunsen Str. 1
D-67098 Bad Dürkheim
+49 (6322) 9567-0
www.cml-it.com

16. Radiation pattern for Cyan

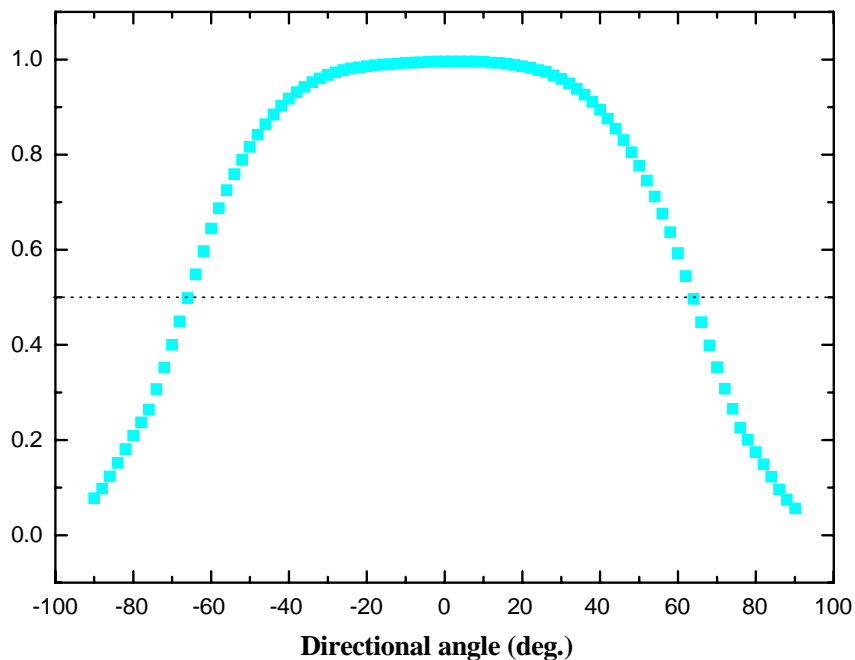

17. Radiation pattern for Amber

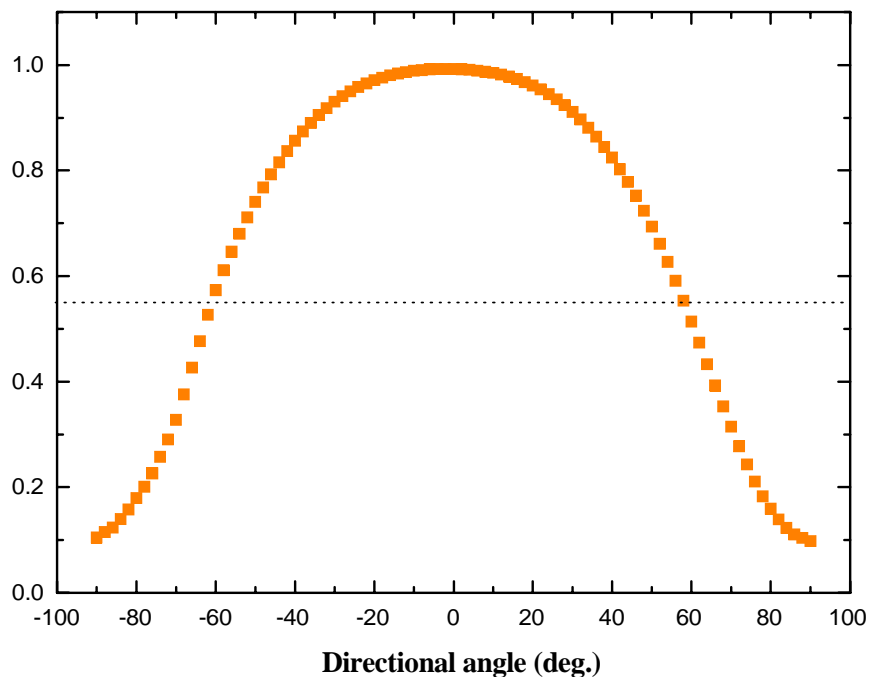

Americas
147 Central Avenue
Hackensack, NJ 07601
(201) 489-8989
www.cml-it.com

Europe
Robert Bunsen Str. 1
D-67098 Bad Dürkheim
+49 (6322) 9567-0
www.cml-it.com

18. Forward Current vs. Wavelength shift ($T_a=25^\circ\text{C}$)

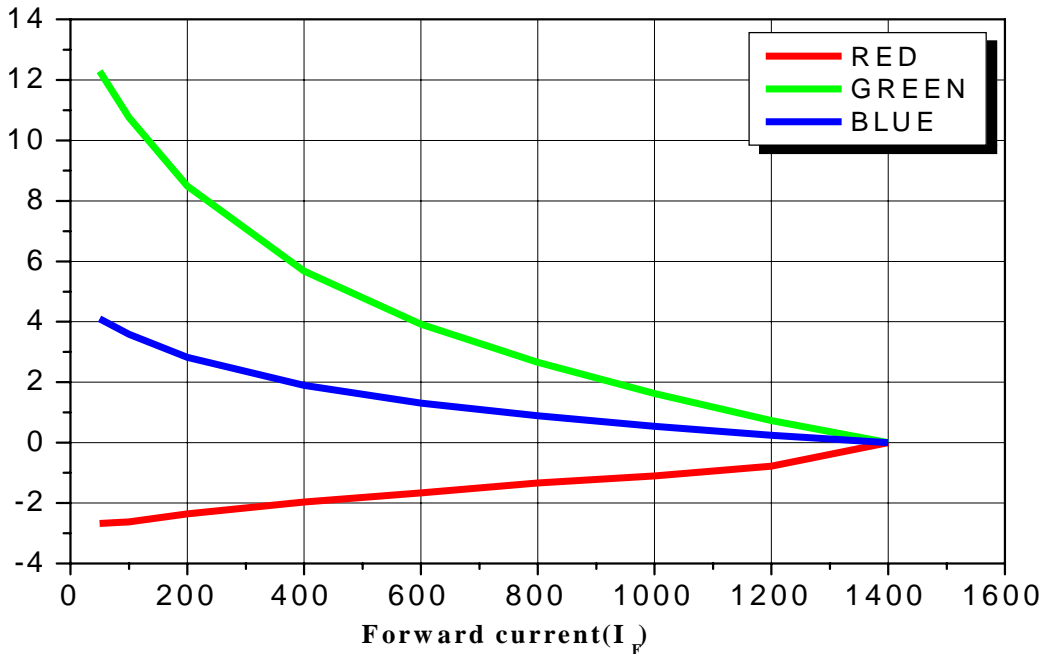

19. Temperature of Junction vs. Relative Light Output for Blue, Green, Red ($T_a=25^\circ\text{C}$)

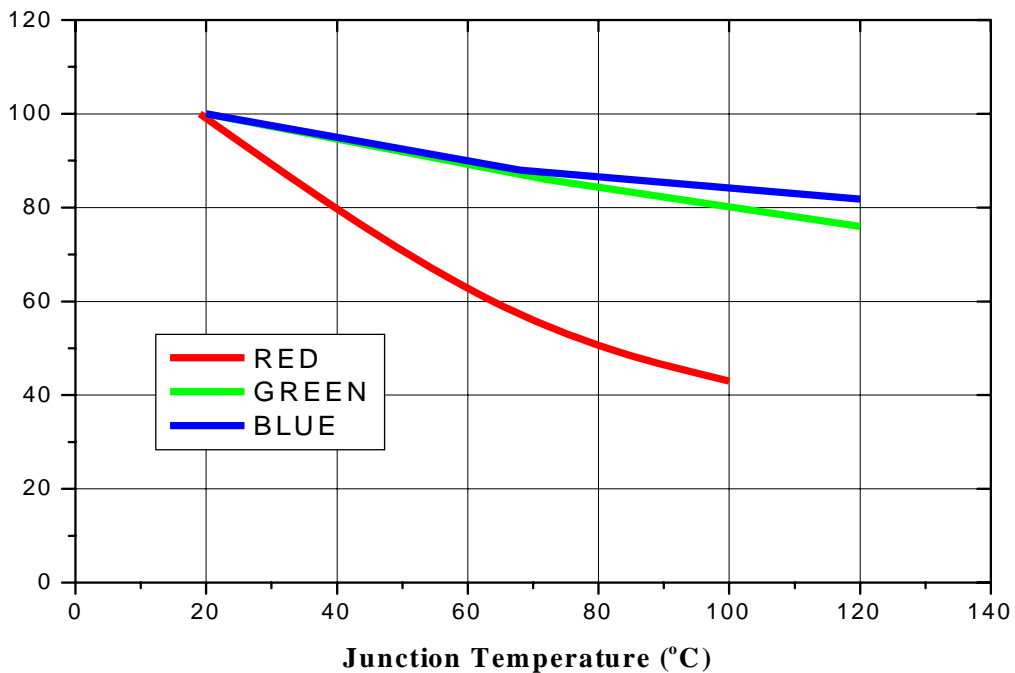

Americas
 147 Central Avenue
 Hackensack, NJ 07601
 (201) 489-8989
www.cml-it.com

Europe
 Robert Bunsen Str. 1
 D-67098 Bad Dürkheim
 +49 (6322) 9567-0
www.cml-it.com

20. Ambient Temperature vs. Allowable Forward Current for White, Blue, Green, Cyan

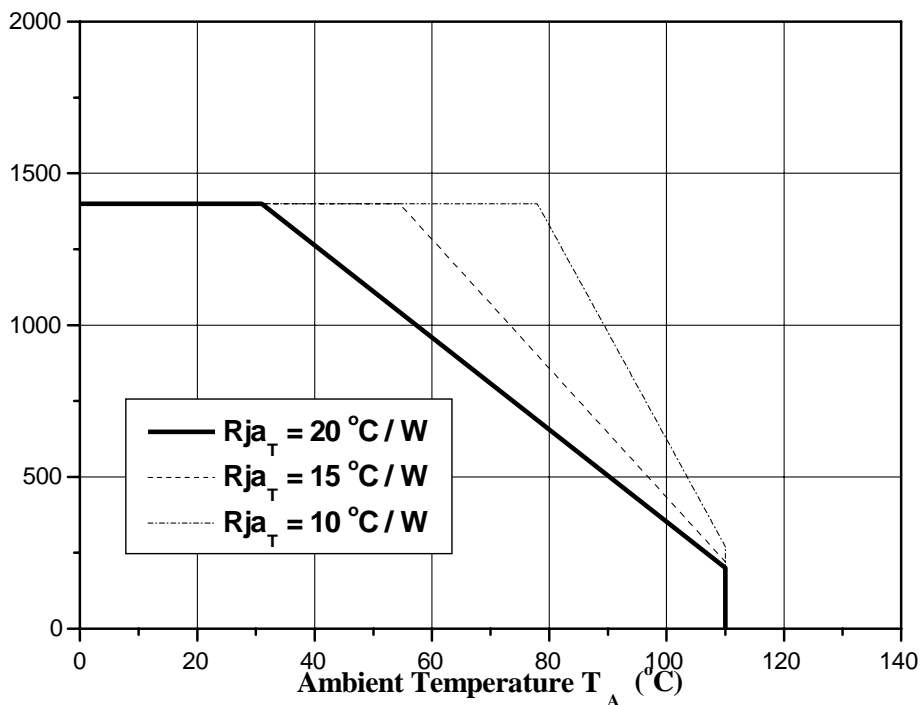

21. Ambient Temperature vs. Allowable Forward Current for Red, Amber

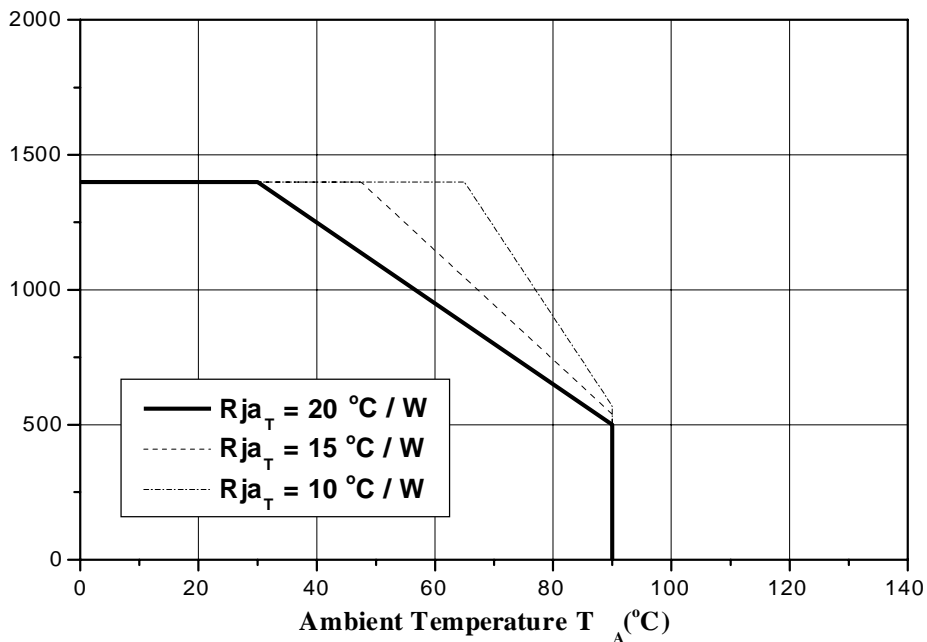

Americas
147 Central Avenue
Hackensack, NJ 07601
(201) 489-8989
www.cml-it.com

Europe
Robert Bunsen Str. 1
D-67098 Bad Dürkheim
+49 (6322) 9567-0
www.cml-it.com

22. Reel Packaging Dimensions (Star type)

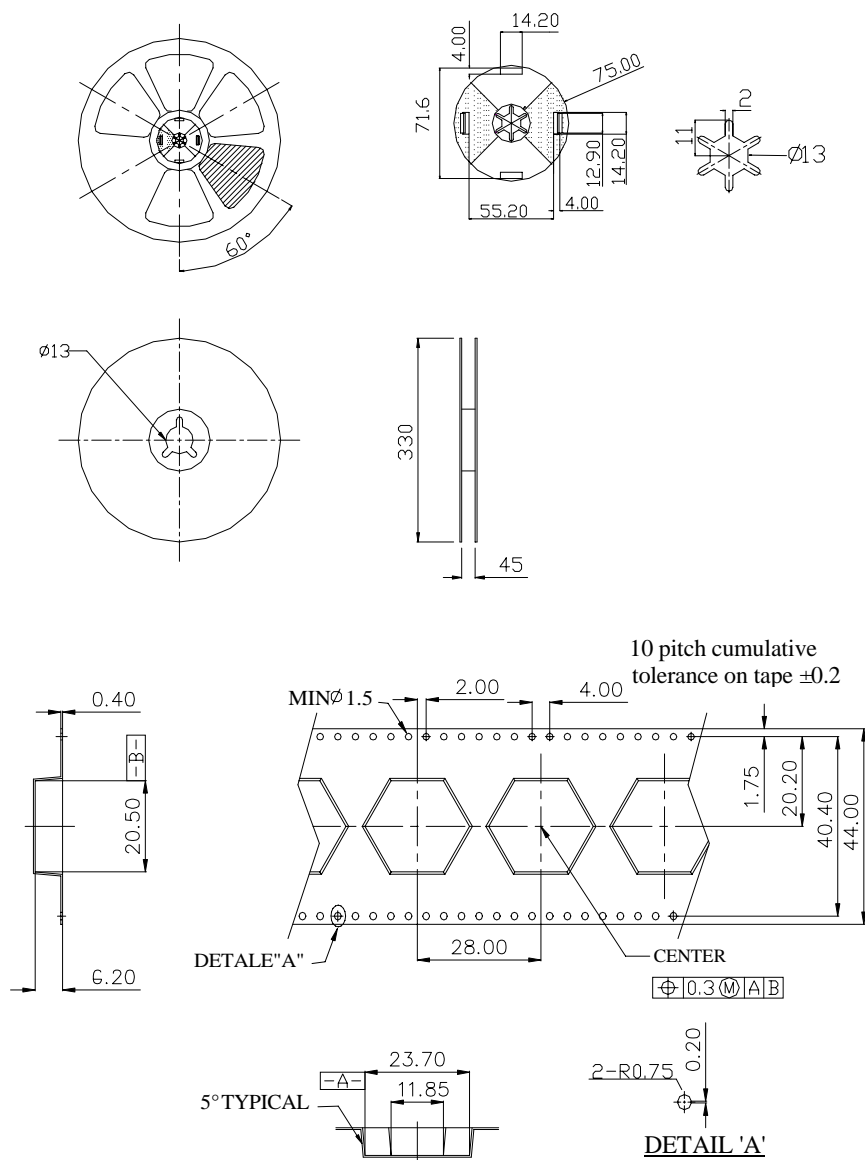

Note : 1. The number of loaded products in the reel is 100 pieces

2. All dimensions are in millimeters

3. Scale : none

4. This drawing is reference only engineering



Americas
147 Central Avenue
Hackensack, NJ 07601
(201) 489-8989
www.cml-it.com

Europe
Robert Bunsen Str. 1
D-67098 Bad Dürkheim
+49 (6322) 9567-0
www.cml-it.com

23. Reel Packaging Dimensions (Square type)

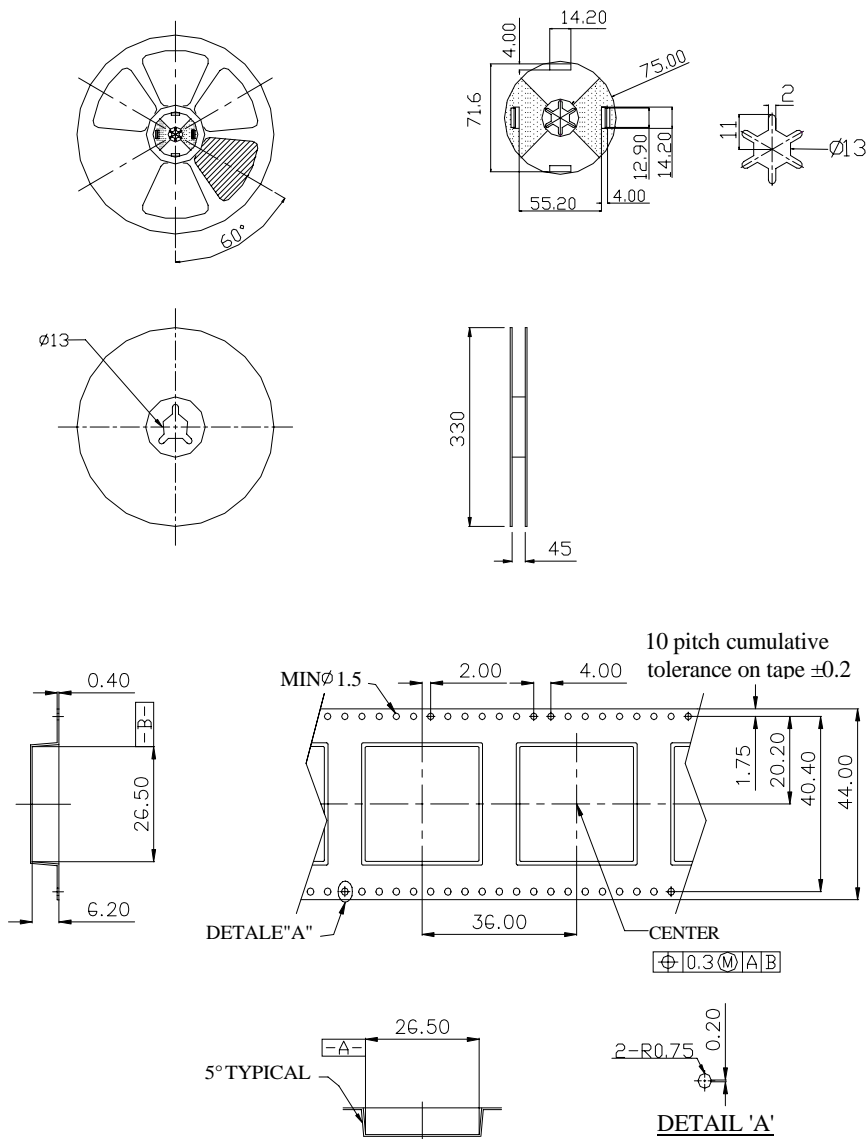

Note : 1. The number of loaded products in the reel is 100 pieces

2. All dimensions are in millimeters
3. Scale is none
4. This is drawing is reference only engineering



Americas
147 Central Avenue
Hackensack, NJ 07601
(201) 489-8989
www.cml-it.com

Europe
Robert Bunsen Str. 1
D-67098 Bad Durkheim
+49 (6322) 9567-0
www.cml-it.com

24. Recommended soldering

1) Solder pad

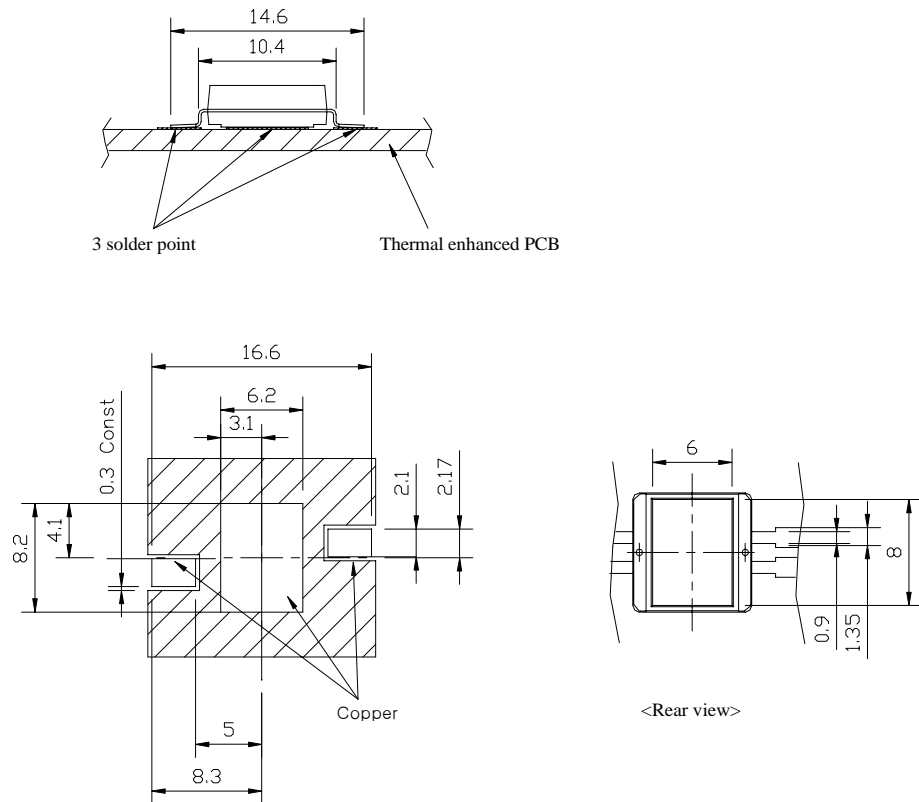

2) Solder paste pattern

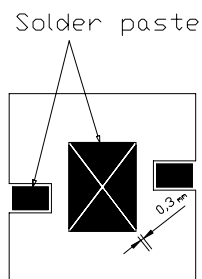

Note : 1. Paste thickness : 0.2mm

25. Soldering Profile ($T_a=25^{\circ}\text{C} \pm 5$ / $\text{RH}=35\% \pm 5$)

(1) Reflow Soldering Conditions / Profile

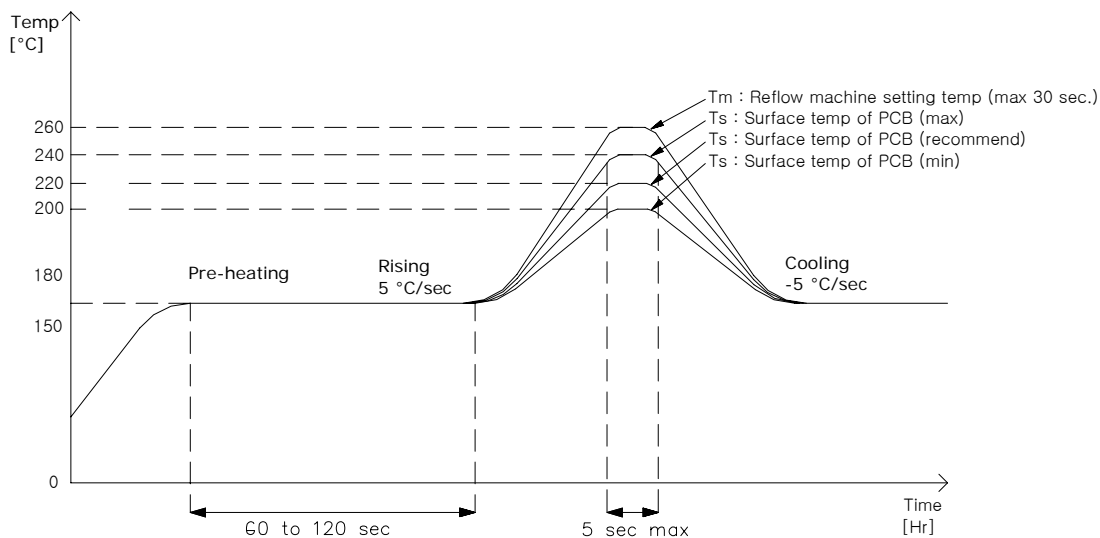

(2) Hand Soldering conditions

- Lead : Not more than 3 seconds @ MAX 280°C
- Slug : Use a thermal-adhesives

* Caution

1. Reflow soldering should not be done more than one time.
2. Repairing should not be done after the LED's have been soldered. When repairing is unavoidable, suitable tools must be used.
3. Die slug is to be soldered.
4. When soldering, do not put stress on the LED's during heating.
5. After soldering, do not warp the circuit board.
6. Recommend to use a convection type reflow machine with 7 ~ 8 zones.



Americas
147 Central Avenue
Hackensack, NJ 07601
(201) 489-8989
www.cml-it.com

Europe
Robert Bunsen Str. 1
D-67098 Bad Durkheim
+49 (6322) 9567-0
www.cml-it.com