

CMI-8738/PCI-6CH C3DX series PCI-Based HRTF 3D Extension Positional Audio Chip

Features

- ✓ **6CH DAC for AC3[®] 5.1CH purpose.**
- ✓ **HRTF-based 3D positional audio, supporting DirectSound[™] 3D and A3D[™] interface**
- ✓ **Supports 4.1/5.1 speakers, C3DX positional audio in 4 / 6 CH speaker mode**
- ✓ **Legacy audio SBPRO[™] compatible**
- ✓ **DLS-based wavetable music synthesizer, supports DirectMusic[™]**
- ✓ **Professional digital audio interface supporting 24-bit SPDIF IN and OUT (44.1K and 48K format)**
- ✓ **Built-in 32ohm Earphone buffer**
- ✓ **Built-in PCtel[®] HSP56 Modem[™] interface**
- ✓ **Drivers support EAX[®], Karaoke Key, Echo...**
- **MPU-401 port/ Dual game port**
- **16-bit full duplex CODEC**
- **Built-in ZV port**
- **32-bit PCI bus master**
- **External E²PROM interface**
- **Single chip design, digital power +3.3V, analog power +5V, 128 pins QFP**

With high speed PCI V2.1 bus controller and legacy audio SBPro[®] DSPemulator, CMI8738 is designed for PC add-in cards and all-in-one motherboards. No external CODEC is needed in CMI8738: CMI-8738 supports the legacy audio – SBPRO[™], FM emulator/DLS wavetable music synthesis, and HRTF 3D positional audio functions. Drivers support EAX[®], Karaoke Key, Echo.....functions. Above all CMI8738 supports PCtel[®] HSP56 (1789) interface.

Being compatible with A3D[™] and DirectSound[™] 3D, CMI8738 meets PC99[®] requirements, and supports professional digital audio interface such as 24-bit SPDIF IN (0.5V ~ 5V) and OUT(44.1K and 48K format).

CMI8738 uses HRTF 3D extension technology to enhance traditional HRTF 3D positional audio by substituting two-speaker system by four or six - speaker one (it supports additional 2 ch 16-bit DAC to provide rear side audio and another 2 ch for subwoofer/Center). It greatly improves HRTF 3D positional audio quality and successfully removes the sweet spot limitations: users can enjoy genuine 3D audio gaming effects, and don't have to worry about the environmental confinement any more.

Being outstanding for its full audio functions, competitive price, and power management, CMI-8738 is the best choice for people seeking for optimum use of the PC applications.

C-Media licensed HRTF 3D library from Central Research Lab (CRL[®]), U.K, who provides one of the world's best HRTF libraries (CRL[®] also licensed its audio technology to YAMAHA[®], ESS[®], and other well-known sound chip makers).

CMI-8738/PCI Block Diagram

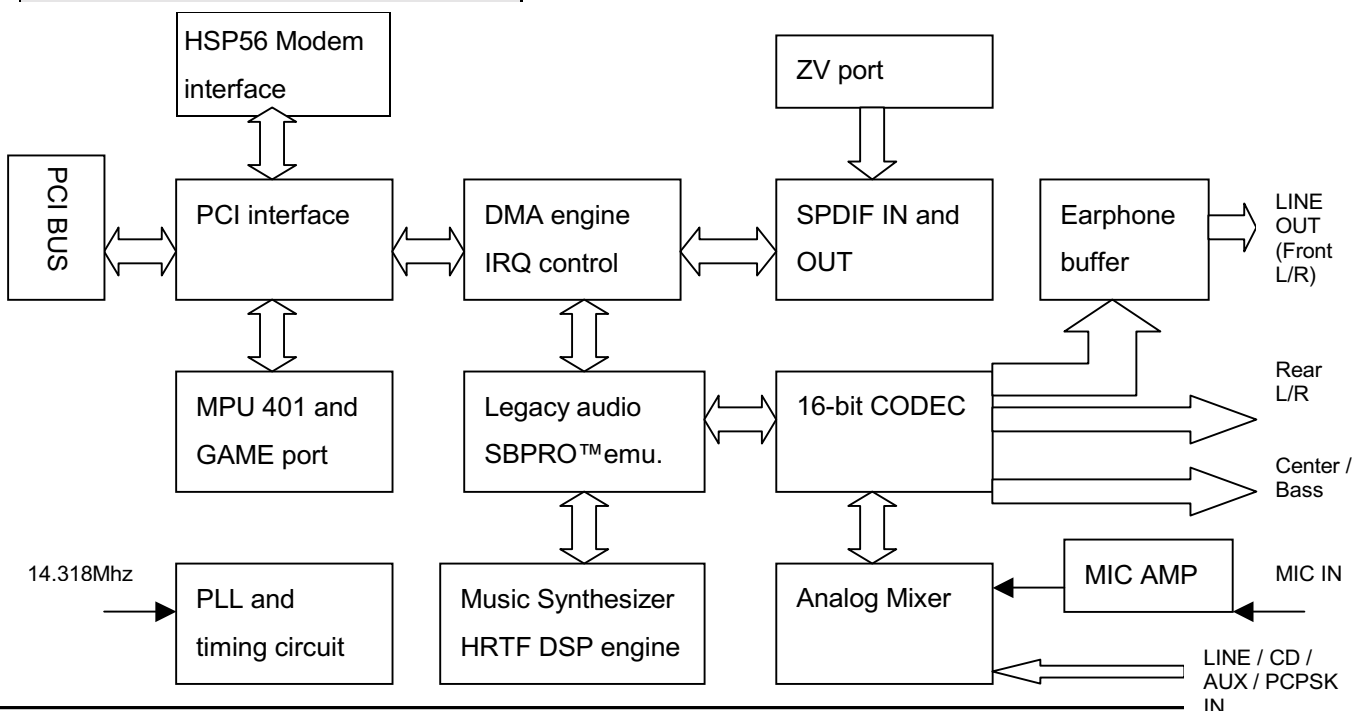

CMI8738/PCI-6CH C3DX Series Chip Function List

Model	MODEM	SPDIF/ZVport
CMI8738/PCI-6CH	YES	YES
CMI8738/PCI-6CH-MX	NO	YES
CMI8738/PCI-6CH-LX	NO	NO

DIGITAL PIN DESCRIPTION

Name	Number	PIN Type	Definition
XA31-XA0	126-128,1-2,5-7,12-16,19-21,32-35,38-41,43-44,47-52	I/O	PCI bus address and data lines
XINTA	117	O	Interrupt request , active-low.
XINTB	118	O	Modem Interrupt request,active-low
XPRST	119	I	Reset
XCLK33	120	I	PCI bus clock.
XGNT	121	I	Bus master grant, active-low.
XREQ	122	O	Bus master request, tri-state output, active-low.
XIDSEL	9	I	ID select, active-high.
XFRAME	23	I/O	Cycle frame, active-low.
XIRDY	24	I/O	Initiator ready, active-low. The bus master device is ready to transmit or receive data
XTRDY	25	I/O	Target ready, active-low. The target device is ready to transmit or receive data
XDEVSEL	26	I/O	Device select, active-low. The target device has decoded the address of the current transaction as its own chip select range.
XSTOP	29	I/O	Stop transaction, active-low. The target device request to the master to stop the current transaction.
XPAR	30	I/O	Parity. The pin indicates even parity across XA31-XA9 and XCBE3-0 for both address and data phases.
XCBE3,2,1,0	8,22,31,42	I/O	Multiplexed command/byte enable. These pins indicate cycle type during the address phase of a transaction.
VDD	4,10,18,27,37,45,54,115,124	+3.3V	Digital and PCI I/O power pin
Vcore	54,115	+3.3V	Digital and PCI I/O power pin
GND	3,11,17,28,36,46,53,116,115	GND	Digital and PCI I/O ground
XIN	55	I	14.318Mhz crystal, or external clock input
XOUT	56	O	14.318Mhz crystal
XGD7-XGD4	97-94	I	Game port switch input pin. Switch D to switch A
XGD3-XGD0	93-90	I/O	Game port resistor input pin. RC3 to RC0
XTXD	88	O	MIDI transmit data
XRXD	89	I	MIDI receive data
XSPDIFO	98	O	44.1k/48kHz SPDIF output
XSPDIFI	86	I*	44.1k/48kHz SPDIF input
XSPDIF2	113	I	Secondary SPDIF input (5v only)
XBIO3-XBIO0	109-112	I/O	General purpose I/O
VDD5V	83	+5V	PCI I/O power pin

VDDM	100	+3.3V	Digital and PCI I/O power pin
DGND	99	GND	Digital and PCI I/O ground
XEECS	84	O	EEPROM chip select
XGPBIO	87	O	General purpose I/O pin (default=high)
XMDSEL	114	I	Modes chip select (high:enable)
XRING	101	I	Ring detection input
XOFFHOOK	102	O	Off-hook control output
XAFERST	103	O	Reset signal for MODEM DAA
XHSPFS	105	O	DAA frame SYNC
XHSPDI	106	I	DAA data input
XHSPDO	107	O	DAA data output
XAFEMCLK	108	O	DAA master clock
XSCLK	104	O	DAA serial clock
XMOUT	58	O	MODEM crystal output (18.432MHz)
XMIN	57	I	MODEM crystal input
XMBCSZ	85	I	Audio chip select (low:enable)
ZVLRCK	113	I	ZV port LR channel clock
ZVSDI	86	I	ZV port data input

ANALOG PIN DESCRIPTION

AVDD	61,81	+5V	Analog power
AGND	60,82	GND	Analog ground
XADOUTL-R	64,65	AI/O	Line out (front channels L/R)
XADCHL-R	66,67	AI/O	ADC filter
XADOUTC	68	AI/O	Center channel output
XADOUTB	69	AI/O	Bass channel output
NC	63	-	Not connect
XCDL-R XCDGND	71,72,70	AI	CD audio differential input
XLNL-R	75,76	AI	Line in or Rear channels out
XAUXL-R	77,78	AI	Aux. Line in
XPCSPKIN	79	AI	PC beep signal or Mono in
XMICIN	80	AI	Microphone in
XREARL-R	73,74	AI/O	Rear channels L/R out
EXTBASS	59	AI	External bass channel input

POWER ON CONFIGURATION PIN

Name	Number	Definition
XEECS	84	4/6 channel selection. For 4 or 6 channel purpose selection. This pin tie high mean 6ch, pull down compatible with 4ch chip.

ELECTRICAL CHARACTERISTICS

Absolute Maximum Ratings

Ratings	Symbol	Value	Units
Digital power voltage	VDD	VDD±5%	V
Analog power voltage	AVDD	AVDD±5%	V
Operating temperature range	TO	0 to 70	°C
Storage temperature range	TST	-40 to 125	°C
Maximum power dissipation	PDMAX	300	MW

Digital Characteristics

PARAMETER	Symbol	Min	Typ	Max	Unit
Input high voltage(PCI I/O)	VIH	2.		VDD+0.3	V
Input low voltage (PCI I/O)	VIL	-0.5		0.8	V
Output high voltage	VOH	2.4		VDD	V
Output low voltage	VOL	0.0	0.2	0.4	V
SPDIF IN input high voltage	VIH1		2.6		V
SPDIF IN input low voltage	VIL1		2.4		V
SPDIF output high voltage	VOH1		VDD		V
SPDIF output low voltage	VOL1		VSS		V
Output low current		4	8		mA

Audio Characteristics

PARAMETER	Symbol	Min	Typ	Max	Unit
Analog input voltage	Avin		1.1		Vrms
Analog output voltage	Avout		1.1		Vrms
A-A S/N ratio			85		dB
A-A THD			0.09		%
ADC S/N ratio			80		dB
ADC THD			0.1	0.2	%
DAC S/N ratio			80		dB
DAC THD			0.1	0.2	%
SPDIF IN/OUT S/N ratio			120		dB
SPDIF IN/OUT THD			0		%
Microphone input level		20		200	mv
Microphone booster				20	dB

PCI Configuration Spaces (Audio)

- 00h 13F6** : (**Vender ID**) read only
- 02h 0111** : (Device ID) read only
- 04h 0006** : Command (State after #RST all is "0")
- 0 (bit 9) Fast back-to-back enable
 - 0 (bit 8) #SERR enable (R/W)
 - 0 (bit 7) Wait cycle control
 - 0 (bit 6) Parity error response
 - 0 (bit 5) VGA palette snoop
 - 0 (bit 4) Memory write and invalidate enable
 - 0 (bit 3) Special cycles
 - 1 (bit 2) Bus master (**R/W**)
 - 0 (bit 1) **Memory space**
 - 1 (bit 0) I/O space (**R/W**)
- 06h 0280** : Status
- 0 (bit 15) Detected Parity Error
 - 0 (bit 14) Signaled System Error
 - 0 (bit 13) Received Master Abort
 - 0 (bit 12) Received Target Abort
 - 0 (bit 11) Signaled Target Abort
 - 01 (bits 10-9) **DEVSEL timing** 00-fast, 01-medium, 10-slow
 - 0 (bit 8) Data Parity Error Detected
 - 1 (bit 7) **Fast Back-to-Back Capable**
 - 0 (bit 6) UDF Supported
 - 0 (bit 5) 0-33MHz ,1-66MHZ Capable
 - 00000 (bits 4-0) Reserved
- 08h 10** : Revision ID
- 09h 040100** : Audio device
- 0Ch 00** : Cache Line Size
- 0Dh 20** : **Latency Timer**
- 0Eh 80** : Header Type
- 0Fh 00** : BIST

10h 0000d401 : I/O of length : -65280(ffff0100h) : First Base Address register
14h 00000000 : Uninitialized : Second Base Address register
18h 00000000 : Uninitialized : Third Base Address register
1Ch 00000000 : Uninitialized : Fourth Base Address register
20h 00000000 : Uninitialized : Fifth Base Address register
24h 00000000 : Uninitialized : Sixth Base Address register
28h 00000000 : Cardbus CIS Pointer
2Ch 13f6 : **(SubSystem Vender ID) (R/W)**
2Eh ffff : **SubSystem ID (R/W)**
30h 00000000 : Expansion ROM Base Address
34h 00000000 : Reserved
38h 00000000 : Reserved
3Ch 05 : **Interrupt Line**
3Dh 01 : **Interrupt Pin**
3Eh 02 : **Min Grant**
3Fh 18 : **Max Latency**
40h 06020001: **Power management reg.**

PCI Configuration Spaces (Modem)

00h 13F6: (Vender ID) read only

02h 0211: (Device ID) read only

04h Command (State after #RST all is "0")

0 (bit 9) Fast back-to-back enable (read only)

0 (bit 8) #SERR enable (Read only)

0 (bit 7) Wait cycle control (read only)

0 (bit 6) Parity error response (read only)

0 (bit 5) VGA palette snoop (read only)

0 (bit 4) Memory write and invalidate enable (read only)

0 (bit 3) Special cycles (read only)

0 (bit 2) Bus master (read only)

0 (bit 1) Memory space (R/W)

1 (bit 0) I/O space (read only)

06h Status

0 (bit 15) Detected Parity Error

0 (bit 14) Signaled System Error

0 (bit 13) Received Master Abort

0 (bit 12) Received Target Abort

0 (bit 11) Signaled Target Abort

01 (bits 10-9) DEVSEL timing 00-fast, 01-medium, 10-slow

0 (bit 8) Data parity Error Detected

0 (bit 7) Fast Back-to-Back Capable

0 (bit 6) UDF Supported

0 (bit 5) 0-33MHz, 1-66MHz Capable

1 (bit 4) PCI power down enable status

0000 (bits 3-0) Reserved

08h X20: Revision ID

09h X078000: Communication device (Modem)

0Ch X00: Cache Line Size

0Dh X00: latency Timer

0Eh X80: Header Type (Multifunction device)

0Fh X00: BIST

10h Xbbbb000: Allocate 32 double word I/O space.

14h X0000000: not used - Second Base Address register

18h X0000000: not used - Third Base Address register

1Ch X0000000: not used- Fourth Base Address register

20h X0000000: not used- Fifth Base Address register

24h X0000000: not used- Sixth Base Address register

28h X0000000: Card bus CIS Pointer

2Ch X13f6: Sub-System Vendor ID (Value can be replaced after reset.) (R/W)

2Eh X0211: Sub-System ID (Value can be replaced after reset) (R/W)

*Refer to the Audio PCI registers bit-13 of address (18-1B) for how to replace.

30h X0000000: Expansion ROM Base Address

34h X0000040: pointer to the power-saving registers. (Read only)

38h X0000000: Reserved

3Ch X00: Interrupt Line (R/W)

3Dh Interrupt Pin(X01 share interrupt/X02 not share interrupt with Audio)

*Select from the power on pin configuration

3Eh X00: Min Grant(not used)

3Fh X00: max Latency(not used)

40h XEC420001(read only)

44h-47h

B0-B1: PMST (R/W) (00)

B7-B2: all 0 (read only)

B8: PMEEN (R/W) (Sticky bit)

B12-B9: DSEL (R/W) 0000

B14-B13: all 0 (read only)

B15: PMESTS (Sticky bit)

CMI8738 SPDIF IN/OUT Test Report

CMI8738 SPDIF-out Frequency, Distortion Noise Response 03/04/99 12:19:31

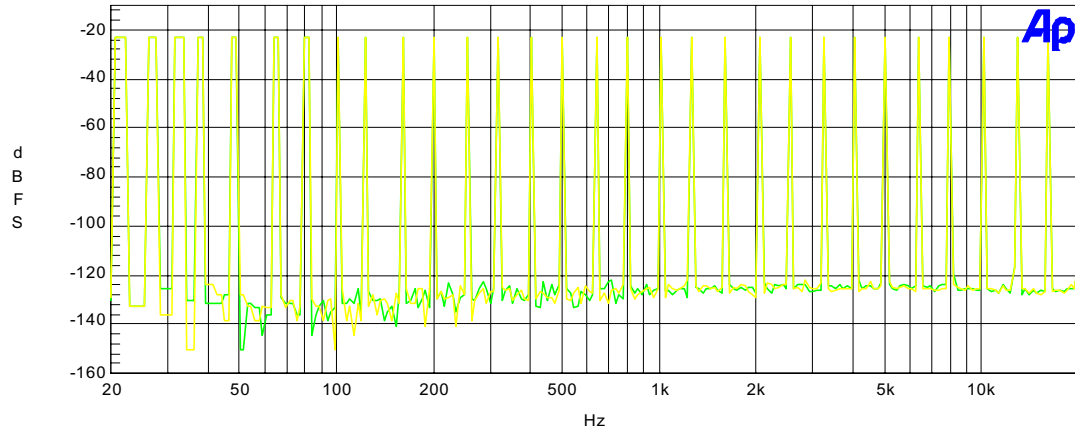

Color	Line Style	Thick	Data	Axis
Green	Solid	1	Fasttest.Ch.1 Ampl	Left
Yellow	Solid	1	Fasttest.Ch.2 Ampl	Left

CMI8738 SPDIF-in Frequency, Distortion Noise Response 03/04/99 14:11:15

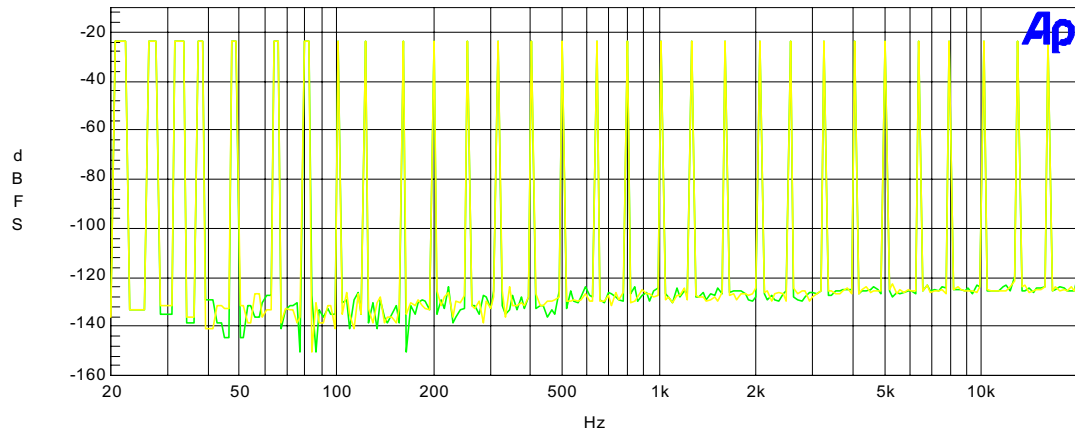

Color	Line Style	Thick	Data	Axis
Green	Solid	1	Fasttest.Ch.1 Ampl	Left
Yellow	Solid	1	Fasttest.Ch.2 Ampl	Left

CM18738 SPDIF-through Frequency, Distortion Noise Response 03/04/99 12:36:04

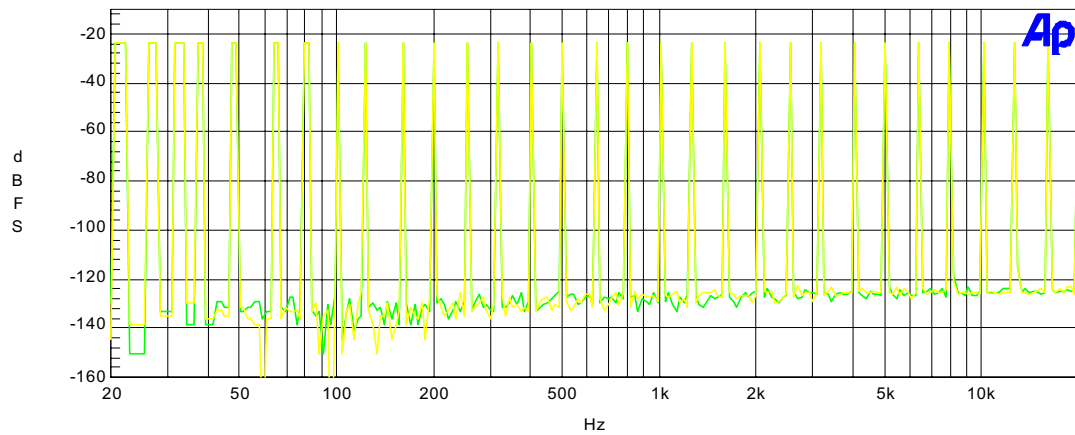

Color	Line Style	Thick	Data	Axis
Green	Solid	1	Fasttest.Ch.1 Ampl	Left
Yellow	Solid	1	Fasttest.Ch.2 Ampl	Left

1. **SPDIF OUT (playback) > 120db**
2. **SPDIF IN (recording) > 120db**
3. **SPDIF through mode (bypass) > 120db**

* This report is generated by Audio Precision® System II using multi-tone mode.

1. Stereo

It is only one-dimensional, as sounds come from (left /right) the physical location of speakers.

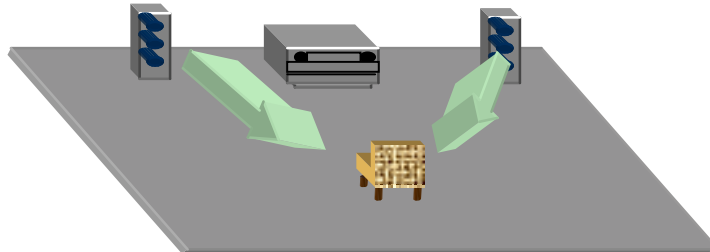

2. Surround (Stereo Expander)

It filters the existing stereo signal to make the sounds fill in the area around the speakers, and in front of the listener. Sound sources appear to come from outside the physical locations of the speakers.

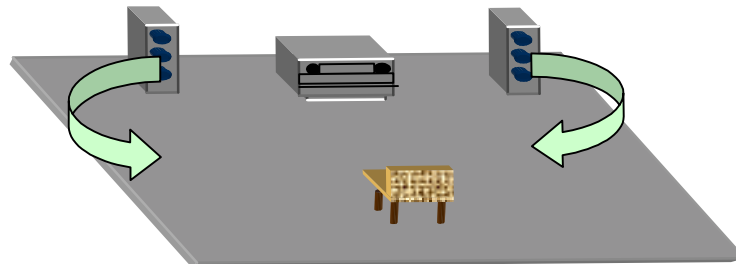

3. Multi-Speaker Surround (Dolby Pro Logic or Digital AC-3)

It uses five speakers instead of two to surround the listener; hence, sound sources come from five directions and create engaging audio experience. This surround sound effect, however, has to be pre-recorded, and it does not support interactive environment.

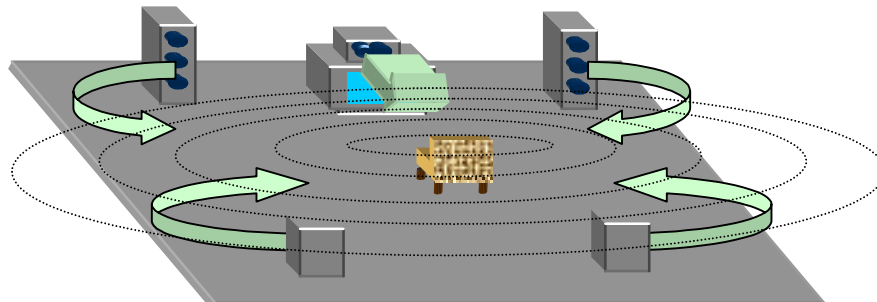

4. HRTF 3D Positional

Audio Processing Technology

3D (C-Media 3D)



Only this sound processing technology can be called real 3D manifestation, as 3D usually refers to the three dimensions of X, Y and Z. This technology allows people to pin-point the location of sound in the real world (up/down, left/right, front/back) using only two speakers or a pair of headphones. This technology also supports interactive 3D applications to get a real-time placement of sounds via API (application programming interface) such as Microsoft DirectSound3D™. We can also use this technology to simulate Multi-speaker Surround with two physical speakers to deliver five "virtual" speakers in the air, surrounding the listener and creating home theater sound environment. This is the most economical and the easiest solution to people who would like to get high performance surround sound but don't want to spend money in adding extra speakers.

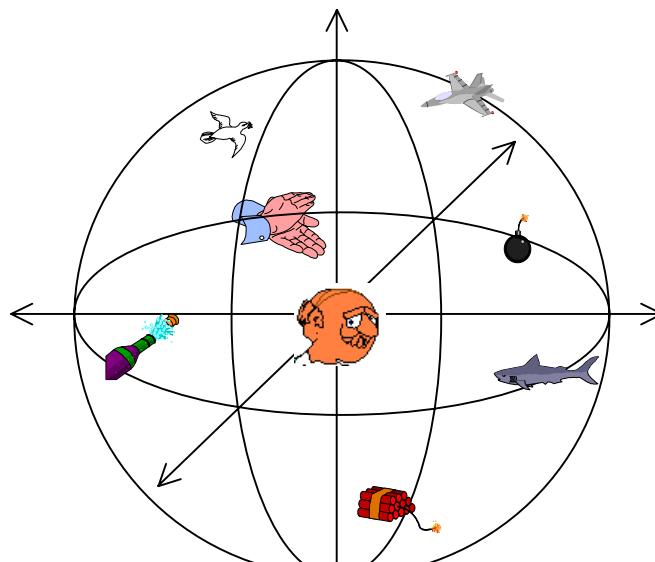
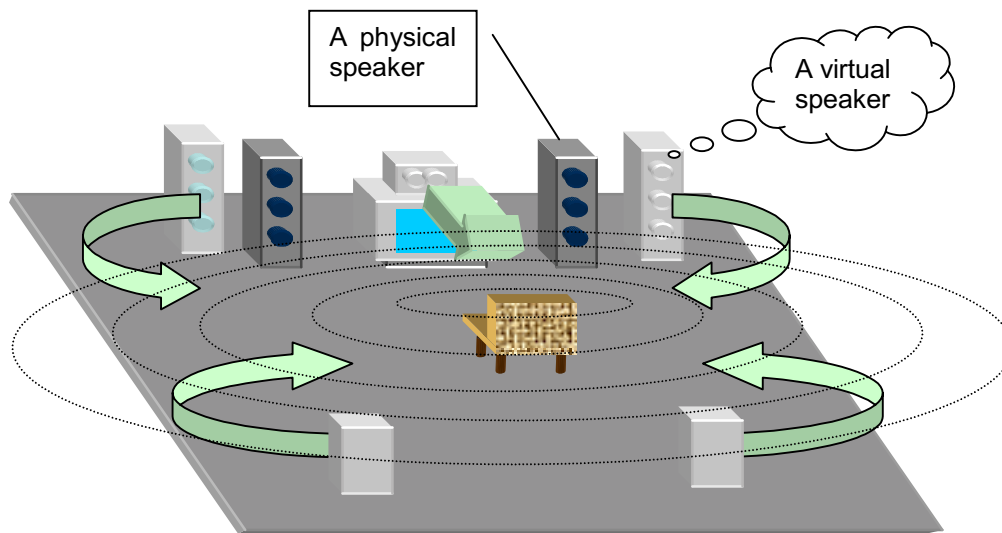

5. HRTF 3D Extension Positional (C-Media 3DX)

3D illusion exists because traditional 3D positional audio system assumes the user's position as the sweet spot to design crosstalk-cancellation circuit; therefore, if the user wants to have 3D positional audio effects, he can't move his head or position out of sweet spot. Another 3D illusion fails because half the population are compulsive "head-turners" who will never get 3D audio from two speakers. To remedy this, C-Media utilizes HRTF 3D extension technology (C3DX) to enhance traditional HRTF 3D positional audio by substituting two-speaker system by four-speaker one. Therefore, at least one or two speakers should be placed behind the listener's head to complement the rear-side effect, thus creating compelling realistic sound. This technology greatly improves HRTF 3D positional audio quality, and successfully eliminates the sweet spot limitation. Users can enjoy the real 3D audio gaming effects, and don't have to worry about the environmental confinement any more.

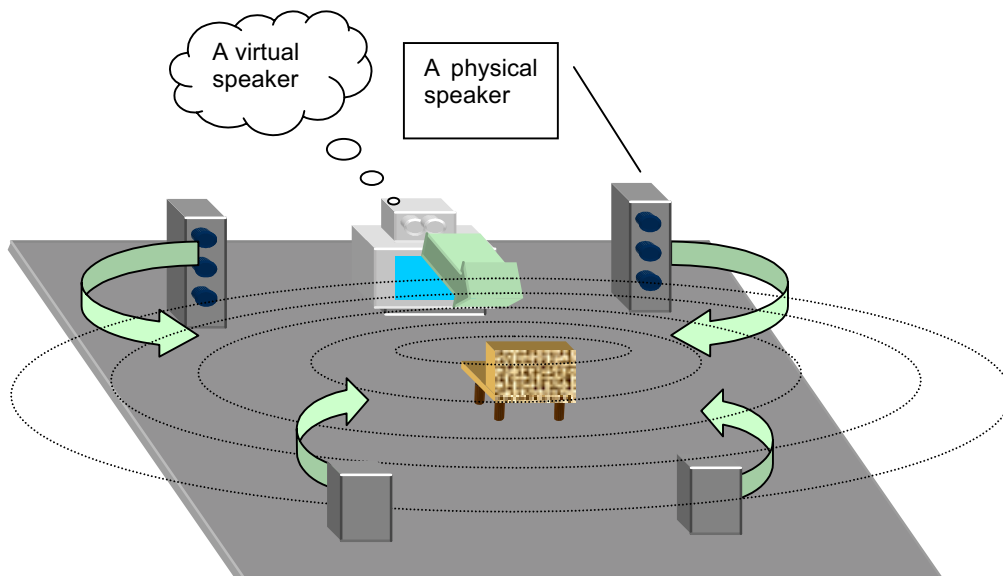

C3D HRTF Positional Audio Technology

C3D technology uses an audio filter called Head Related Transfer Functions (HRTFs), which is licensed from CRL®(Central Research Lab). The basic concept of C3D is: since we can hear sound three dimensionally in the real world using our two ears, it must be possible to regenerate the same sound effect from two loud speakers.

What is HRTF ?

HRTF (Head Related Transfer Functions) is a set of audio filters which can vary locations of sound effects (spatial hearing cues) in three-dimension measured from the listener's eardrum.

People can use this technology and special digital signal processing to re-create spatial hearing cues, so as to makes the ears hear a realistic and three-dimensional sounds coming from a pairs of loud speakers or headphones.

There are several listening cues which allow people to hear sounds three-dimensionally :

(I). Spatial Hearing : Primary 3D-cues

1. IAD

The head shadowing effect creates differences in the amplitudes of the sound signals arriving at each ear from the source. The effects of diffraction are most noticeable in the range between about 700 Hz to 8 KHz, where the A and S functions periodically converge and diverge gently. This Inter-aural Amplitude difference (IAD) is one of the primary 3D sound cues.

HRTF 3D Positional Audio Technology White-Paper

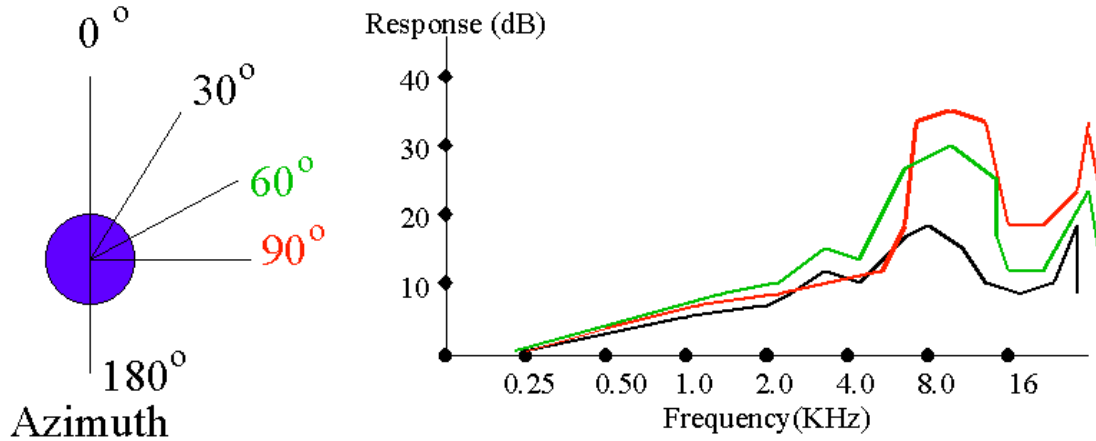

2. ITD

In addition to IAD, there is also a time-of-arrival difference between the left and right ears(unless the sound source is in one of the pole positions, such as directly in front, behind, above and below): this is known as the Inter-aural Time Delay (ITD).

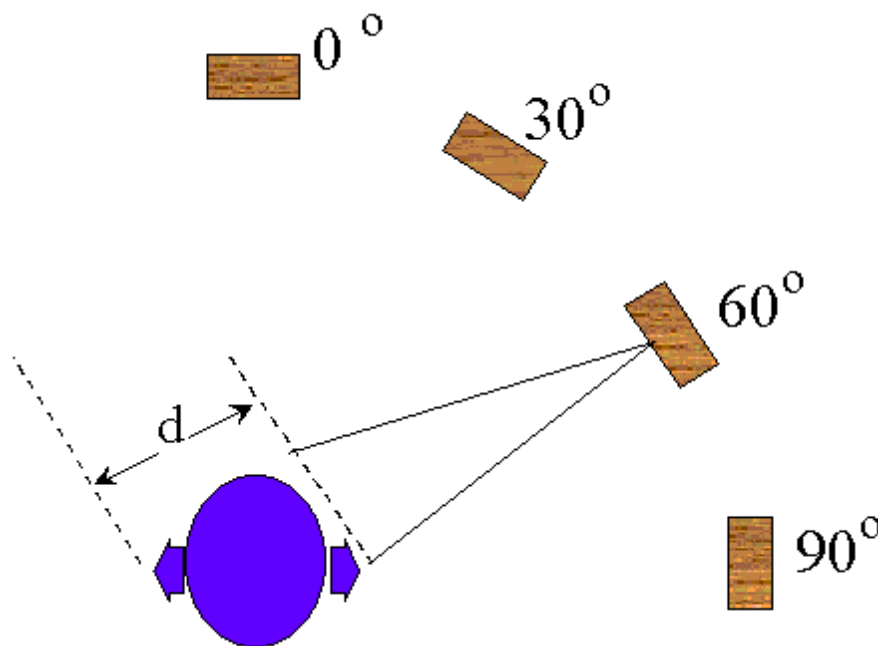

3. Pinna Effects

It has been presumed by several researchers that the convolutions of the pinna create the spectral features which constitute the 'height' cues. In practical experiments by Gardner, in which different parts of the pinna were occluded, and then the ability of a number of subjects to identify sound source positions at different heights was tested, it was shown that the different features all contributed by different amounts. For example, if the fossa is excluded, then height localization capability is impaired, but not totally extinguished. It would be reasonable to conclude that it is the combined effect of the pinna convolutions which create the various localization cues, and it is not valid - or logical - to attempt to assign particular spatial capabilities with individual physical features.

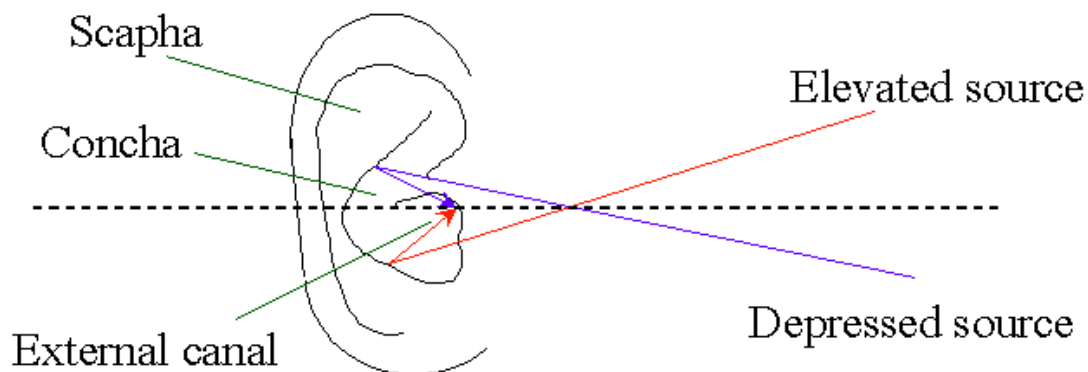

(II). Spatial Hearing : Secondary 3D-cues (shoulder & local reflections)

In addition to the 'primary' 3D sound cues (IAD, ITD and pinna effects), there are several additional cues which do contribute to the localization capability; these will be referred to here as 'secondary' cues, and include shoulder/torso reflections, local room reflections, and psychological cues.

1. Shoulder / Torso reflections

The presence of a torso attached to an artificial head has the effect of increasing the pressure in the vicinity of the ear up to frequencies of around 2 kHz. The effect is greater for frontal sources than lateral ones. In experience, the presence of the torso does not appear to contribute much to spatial accuracy. However, shoulders are located very close to the ears, and their effect is greater, this time, in respect of

lateral sounds. If one listens to an artificial head first without - and then with - shoulder fitments, then it is clear that the shoulders do contribute to spatial effects in certain positions. The shoulders provide a strong reflection from lateral sources, with a short path-length of around 10 cm between direct sound and reflection. The effects are most important for side-positioned sources, especially for "height" effects, where the shoulders tend to mask sources which move below about 30 degree depression.

2. Local, Room Reflections

In simulations, it is clear that the incorporation of first-order simulated room reflections can help in the creation of sound images which have a "solid" nature. However, the effects - if accurately simulated - are relatively slight. Experience has shown that it is primarily the quality of the HRTFs themselves which determine the quality and solidity of the sound image. The further addition of second-order reflections does not help significantly, because in reality, there is a great number of reflections in the average room. A method which does help to recreate the acoustic experience of a room, however, is to use approximate simulations of lateral reverb, using either 2 or 4 laterally placed "virtual" sources at, say, ± 70 degrees and 80 degrees azimuth.

- The quality of the sound image relates to the HRTFs used.
- The quality of the room image relates to addition of reflections and reverb.

3. Psychological Cues

There are clearly psychological cues present in everyday life which work together with the audio cues to tell us about the world around us. For example, if you hear the sound of a helicopter flying, you expect it to be up in the air, and not downwards. If a dog is barking nearby, you would expect it to be downwards.

How to listen to C3D sound correctly and properly?

1. Use Headphones to Have Much Better Effect

When you use headphones in listening, there will be less interference such as outside voices or room reflections comparing to using speakers.

2. Choose Correct Output Devices

Choose the correct output devices in the options of demo program in accordance with what listening devices you want to listen to. Listening through speakers must be proceeded by crosstalk-cancellation, so if you choose the wrong output devices, there won't be any 3D positional audio effect.

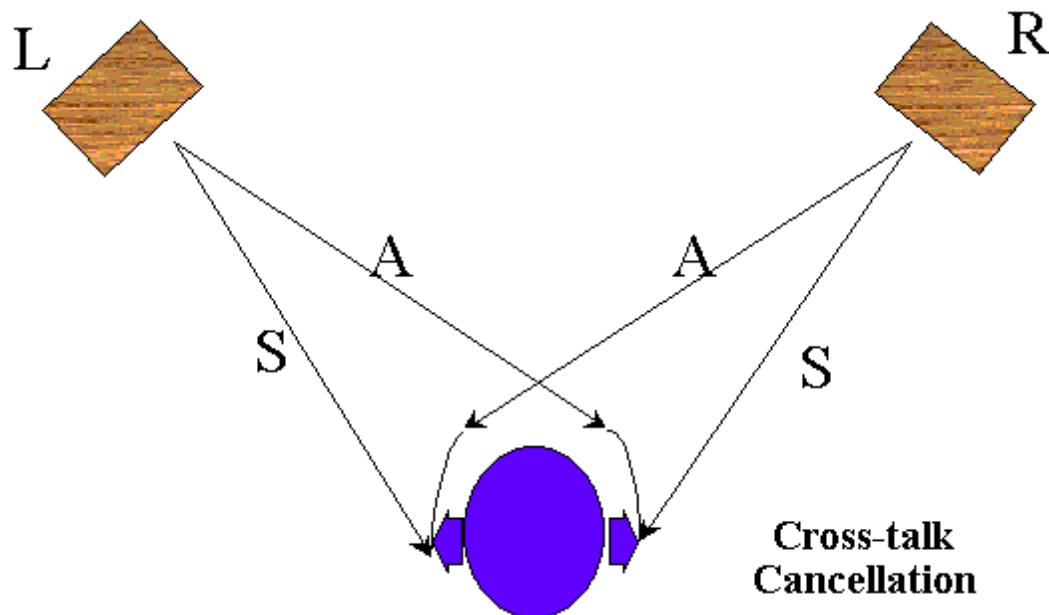

3. Position of Speakers

If you listen from speakers, please do not reverse the left and right speakers, which should be put in equal distance from the listener. That is, the listener, the left, and the right speaker must be in the topmost of a right triangle. The position of the listener is called the “sweet spot”. In addition, the height of the listener’s ears must be equal to that of the speakers.

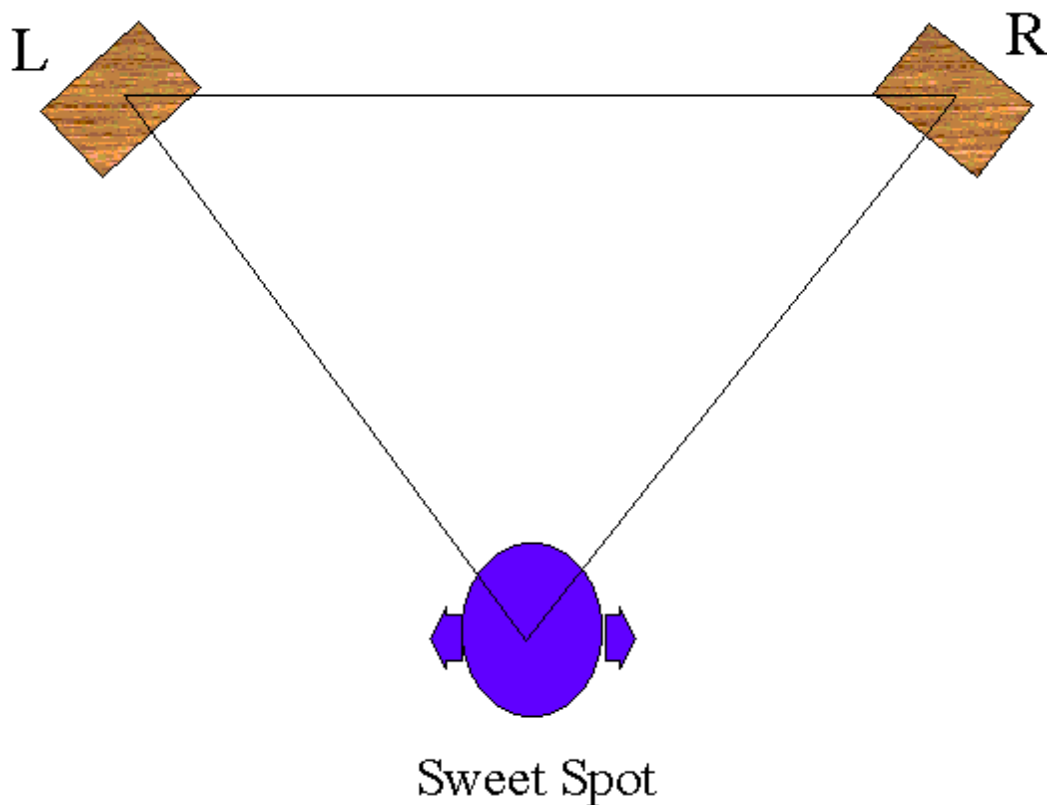

4. Turn Surround Sound Functions off

When the surround sound effect is enabled, it will cause confusion with C3D sound, and make positional sound effect invalid.

CMI8738 PCI Audio Adapter Layout Notes

1. The wires of analog circuits(chip pin64-80) must be wider than 12mil.
2. Placing digital signals such as SPDIF IN/OUT(pin86, 98) and TXD/RXD(pin88,89) near the analog signals should be avoided. However, if these signals have to be adjacent, please place ground between these digital and analog signal wires to isolate noises.
3. The whole PCB grounding should be well-organized(The ground must be placed as much as possible. Also, the ground of both the component and the solder sides should be drilled as much as possible.).
4. The grounding under CMI8738 should be well-organized as mentioned above.
5. The regulator(78L05) must be placed near the chip as much as possible.
6. The chip and the circuits need independent power supply regulators to prevent insufficient currents.