

HITACHI

SERVICE MANUAL

YK

No.009E-1

CMP420V1 / CMP420V2
42EDT41
(PW1A)

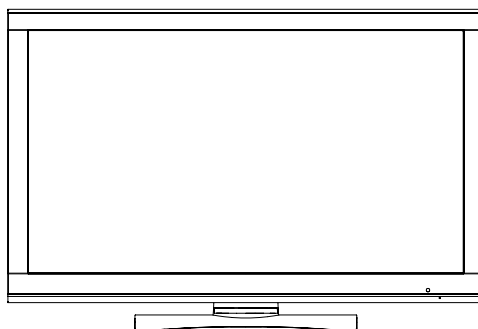

Caution

Be sure to read this manual before servicing. To assure safety from fire, electric shock, injury, harmful radiation and materials, various measures have been provided for in this HITACHI Plasma display service manual. Be sure to read all cautionary items described in the manual to maintain safety before servicing.

Service Warning

1. Since the Panel Module and front Filter are made of glass, handle a broken Module and/or Filter with sufficient care, in order not to be injured.
2. Repair work should not be started until after the Panel Module and the AC/DC Power supply have cooled sufficiently.
3. Special care should be exercised in the proximity of the display area in order not to damage its surface.
4. The Panel Module should not be touched with bare hands, as this will protect its surface from stains.
5. It is recommended to use clean soft gloves during the repair work in order to protect not only the display area of the Panel Module but also the technician.
6. The Chip Tube of the Panel Module (located in the upper left corner of the back of the glass panel) is very fragile; as well, the flat cables connecting the Panel to the drive circuit PWBs are very weak. Take care not to damage these, otherwise, the panel will never light again.

Contents

1. Features -----	3	8. Connector Diagram ..CH.4.....	40
2. Specifications-----	4	9. Wiring Diagram CH 2, CH 3	41
3. Component Names -----	5	10. Basic Circuit Diagram	43
4. Service point-----	6	11. Printed Wiring Board Diagram	47
5. Service Modes -----	7	12. Disassembly Diagram	50
6. Troubleshooting-CH 1	34	13. Replacement Parts List	51
7. Block Diagram -----	37	14. DC Voltages	53

SPECIFICATIONS AND PARTS ARE SUBJECT TO CHANGE FOR IMPROVEMENT.

Plasma Display



August 2004 Digital Media Division



Version 009E-1.4



CAUTION FOR SAFETY







Please read this page before making repairs to the monitor.

This page explains certain safety items found in this manual which are intended to ensure the safety of the technician and to prevent accidents during any repair work.

	Warning	This symbol means " Personnel Electrical Safety Hazard "
	Caution	This symbol means " Equipment Operational Hazard "

	This symbol means " CAUTION "
	This symbol means " POSSIBILITY OF ELECTRIC SHOCK "

	This symbol means " DO IT! "
	This symbol means " DON'T DO IT! "

 WARNING	
<p>■ Special Instructions</p> <p style="text-align: center;"></p> <p>This indicates cabinet, chassis or parts which require special attention. Please follow any notes as well as all safety precautions.</p>	<p>■ Keep the same wiring dress for boards.</p> <p>This monitor uses insulated spacers which are intended to isolate metal parts from electrical components.</p> <p style="text-align: center;"></p> <p>Internal wiring is isolated from components by using clamps, retainers, etc., so please return to original condition for prevention of electrical shock or fire.</p>
<p>■ Prevent electrical shock</p> <p>Please use care and caution when servicing this product. High voltages exist in the set which can cause injury or death.</p> <p style="text-align: center;"></p> <p>Please disconnect the AC power during repair to prevent serious shock or death.</p>	<p>■ Safety check should be done after finished.</p> <p>Every part (removed screws, component and wiring) should be returned to previous condition.</p> <p style="text-align: center;"></p> <p>Check around the repaired area for any damage by mistake. Measure the insulated impedance of AC by ohm meter. Confirm that the value of impedance is greater than 4M ohm. It is possible for electric shock or fire to occur if the value is less than 4M ohm.</p>
<p>■ Use only recommended components.</p> <p style="text-align: center;"></p> <p>Please use the same characteristic components, which is same as previous for your safety. To ensure reliability, specially marked parts (△) should be OEM when replaced. These parts are also safety related, so electrical shock and/or fire could result from using generic parts.</p>	<p>■ Repair to the HDCP circuit is limited.</p> <p style="text-align: center;"></p> <p>Never remove the shield case, which is assembled to code with the HDCP circuit</p>

CMP420V1/CMP420V2/42EDT41 (PW1A)

PRECAUTIONS

- **How to clean the plasma panel screen (front glass) of the monitor**

Before cleaning the monitor, turn off the monitor and disconnect the power plug from the power outlet. To prevent scratching or damaging the plasma screen face, do not wipe the surface with sharp or hard objects. Clean the screen with a soft cloth moistened with warm water and dry with a soft cloth. If it is not clean enough, then use a cloth with glass cleaner. Do not use any harsh or abrasive chemicals.

- **How to clean the cabinet of the monitor**

Use a soft cloth to clean the cabinet and control panel of the monitor. When excessively soiled dilute a neutral detergent in water, wet and wring out the soft cloth and afterward wipe with a dry soft cloth. Never use acid/alkaline detergent, alcoholic detergent, abrasive cleaner, powder soap, OA cleaner, car wax, etc. because they could cause discoloration, scratches or cracks.

1. Features

- **Large-screen, high-definition plasma display panel**

The 42-inch color plasma display panel, with a resolution of 852 (H) x 480(V) pixels, creates a high-definition, large-screen (aspect ratio : 16:9) and low-profile flat display. Free from electromagnetic interferences from geomagnetic sources and ambient power lines, the panel produces medium-quality images free from any color misconvergence or corner focus distortion.

- **High Performance Digital Processor**

A wide range of personal computer signals can be handled, from 640 x 400, 640 x 480 VGA to 1600 x 1200 UXGA. (RGB analog input)

- **Easy-to-use remote control and on-screen-display system (OSD)**

The remote control included eases the setting of display controls. Furthermore, the on-screen-display (OSD), displays the input status control settings in an easy-to-view fashion.

- **Power saving system**

The International ENERGY STAR® power saver feature saves power consumption automatically when input signals are not available.

When connected to a VESA DPMS-compliant PC, the monitor cuts its power consumption while it is idle.

- **TruBass **

TruBass, SRS and  symbols are trademarks of SRS Labs, Inc.

TruBass technology is incorporated under license from SRS Labs, Inc.

[AV MONITOR model] CMP420V1, CMP420V2

- One mini D-sub terminal and one DVI-D terminal for RGB input.
(The D-sub terminal can also receive component RGB - selectable via customer OSD.)
- One composite/S-video input terminal and two component video input terminals, added with VIDEO board.
(One of the component inputs has the capability to select RGB via customer OSD.)
- One SCART terminal for European standard, added with VIDEO board.
(It operates as composite/S-video input and RGB input terminal, or composite video output terminal.)
- One composite video output terminal as a monitoring output, added with VIDEO board.
- Simple type remote (CP-RD4)

[TELEVISION model] 42EDT41

- Various input/output terminals, added with VIDEO board. (same features as above mentioned AV MONITOR)
- Tuner input added with VIDEO board
- Complex type remote (CLU-W900)

CMP420V1/CMP420V2/42EDT41 (PW1A)

2. Specifications

Panel	Display dimensions	Approx. 42 inches (920 (H) x 518 (V) mm, diagonal 1059mm)
	Resolution	852 (H) x 480 (V) pixels
Net dimensions (excluding Speakers/Stand)		1030 (W) x 636 (H) x 91 (D) mm
Net weight (excluding Speakers/Stand)		CMP420V1/V2:33.2kg 42EDT41:34.2kg
Ambient conditions	Temperature	Operating : 5°C to 35°C, Storage : -15°C to 60°C
	Relative humidity	Operating : 20% to 80%, Storage : 20% to 90% (non-condensing)
Power supply		AC100 - 240V, 50/60Hz
Power consumption/at standby		310W / <3W
Audio output		12W + 12W (6 Ω)
(RGB input)		
Input signals	Input terminals	RGB1 DVI input terminal (DVI-D) RGB1 audio input terminal (3.5mm Stereo Mini Jack) RGB2 analog RGB input terminal (D-sub 15-pin) RGB2 audio input terminal (3.5mm Stereo Mini Jack)
	Video signals	0.7 V/1.0 Vp-p, analog RGB (Recommended Signal) 480i, 576i, 480p, 576p, 1080i/50, 1080i/60, 720p/60
	Sync signals	H/V separate, TTL level [2KΩ] H/V composite, TTL level [2KΩ] Sync on green, 0.3 Vp-p [75Ω]
(Video input)		
Input signals	Input terminals	AV1: composite video input terminal (RCA) AV1: Y PB PR video input terminal (RCA) AV1: L/R audio input terminal (RCA) AV2: composite video input terminal (RCA) AV2: Y/G PB/B PR/R video input terminal (RCA) AV2: L/R audio input terminal (RCA) AV3: composite video input terminal (RCA) AV3: S video input terminal (RCA) AV3: L/R audio input terminal (RCA) AV4: composite video / S video / RGB / L/R audio input terminal (Scart)
	Video signals	AV1: NTSC-M, PAL-M, PAL-N AV1: 480i, 576i, 480p, 576p, 1080i/50, 1080i/60, 720p/60 AV2: NTSC-M, PAL-M, PAL-N AV2: 480i, 576i, 480p, 576p, 1080i/50, 1080i/60, 720p/60, RGB AV3: NTSC-M, PAL-M, PAL-N AV4: NTSC-M, PAL-M, PAL-N AV4: RGB
Video output Signal		OUTPUT (MONITOR): composite video monitor-output terminal (RCA) OUTPUT (MONITOR): L/R audio monitor- output terminal (RCA) AV4: composite video / L/R audio monitor-output terminal (SCART)
(RF input)		
Input signals	Input terminals	ANT : 75Ω unbalanced
	RF Video System	NTSC-M

Applicable video signals for each input terminal

Terminal	RCA/SCART				DVI		D-sub	
	CVBS	S-video	Component	RGB	PC	STB	RGB	Component
AV1	○		○					
AV2	○		○	○				
AV3	○	○						
AV4	○	○		○				
RGB1					○	○		
RGB2							○	○

(○ :Available)

3. Component names

[Main unit]

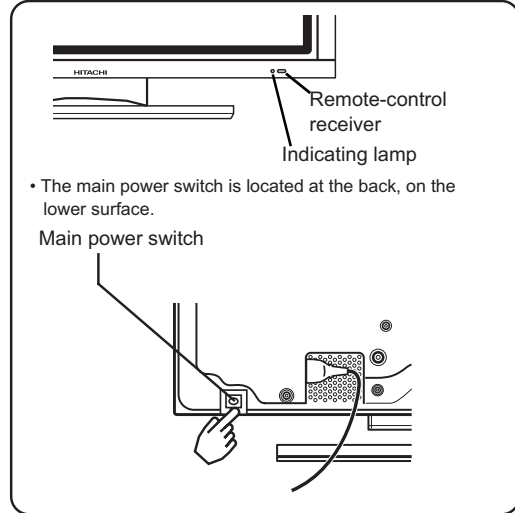
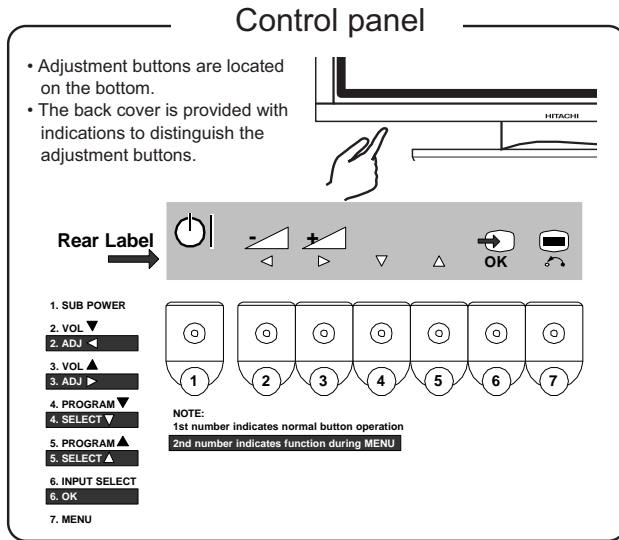

[Remote control]

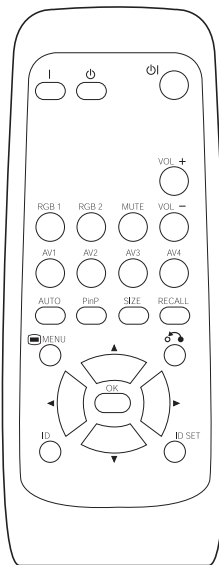

for
CMP420V1
CMP420V2

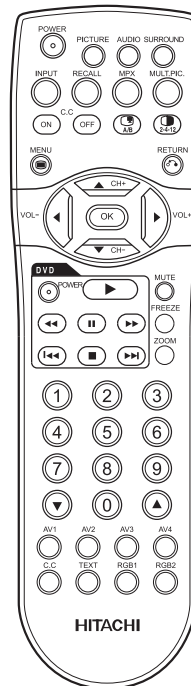

for
42EDT41

4. Service points

● Lead free solder

This product uses lead free solder (unleaded) to help preserve the environment. Please read these instructions before attempting any soldering work.

Caution: Always wear safety glasses to prevent fumes or molten solder from getting into the eyes. Lead free solder can splatter at high temperatures (600°C).

■ Lead free solder indicator

Printed circuit boards using lead free solder are engraved with an "F."

■ Properties of lead free solder

The melting point of lead free solder is 40-50°C higher than leaded solder.

■ Servicing solder

Solder with an alloy composition of Sn-3.0Ag-0.5Cu or Sn-0.7Cu is recommended.

Although servicing with leaded solder is possible, there are a few precautions that have to be taken. (Not taking these precautions may cause the solder to not harden properly, and lead to consequent malfunctions.)

Precautions when using leaded solder

- Remove all lead free solder from soldered joints when replacing components.
- If leaded solder should be added to existing lead free joints, mix in the leaded solder thoroughly after the lead free solder has been completely melted (do not apply the soldering iron without solder).

■ Servicing soldering iron

A soldering iron with a temperature setting capability (temperature control function) is recommended.

The melting point of lead free solder is higher than leaded solder. Use a soldering iron that maintains a high stable temperature (large heat capacity), and that allows temperature adjustment according to the part being serviced, to avoid poor servicing performance.

Recommended soldering iron:

- Soldering iron with temperature control function (temperature range: 320-450°C)

Recommended temperature range per part:

Part	Soldering iron temperature
Mounting (chips) on mounted PCB	320°C±30°C
Mounting (chips) on empty PCB	380°C±30°C
Chassis, metallic shield, etc.	420°C±30°C

— The PWB assembly which has used lead free solder —

- (1) FILTER PWB, SW PWB, LED/RECEIVER PWB, TACT SW PWB, SP TERMINAL(L/R) PWB
- (2) AUDIO PWB, JOINT PWB
- (3) VIDEO PWB
- (4) FORMATTER PWB
- (5) POWER BOARD

5. SERVICE MODE ACCESS

BURN-IN MODE

BURN-IN MODE

When the Burn-in feature is turned ON, the plasma panel operates normally on all inputs that have a signal. On inputs that do not have a signal, the plasma panel displays a cycling single color test pattern (see below) which is generated internally. This can be helpful to determine if the panel is capable of displaying anything.

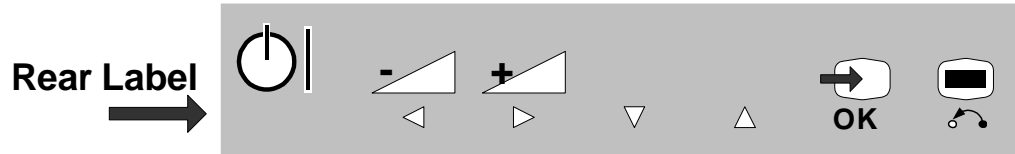

- 1. SUB POWER
- 2. VOL ▼
- 2. ADJ ◀
- 3. VOL ▲
- 3. ADJ ▶
- 4. PROGRAM ▼
- 4. SELECT ▼
- 5. PROGRAM ▲
- 5. SELECT ▲
- 6. INPUT SELECT
- 6. OK
- 7. MENU

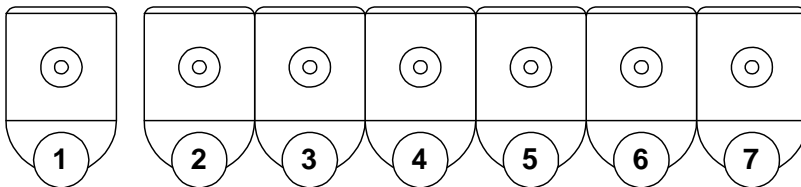

NOTE:
 1st number indicates normal button operation
 2nd number indicates function during MENU

BURN-IN MODE (ON)

With unit in standby mode (turned off), press and hold: >

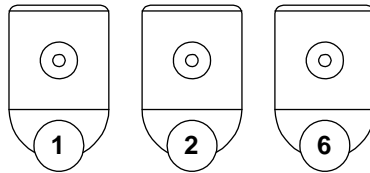

After the unit comes on, continue to hold the buttons down until the initial OSD goes away. OSD will then appear indicating that BURN-IN MODE is engaged. (OSD > **Burn In On**)

BURN-IN MODE (OFF)

With unit in standby mode (turned off), press and hold: >

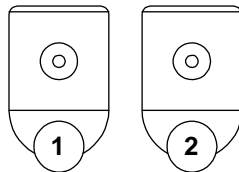

After the unit comes on, continue to hold the buttons down until the initial OSD goes away. OSD will then appear indicating that BURN-IN MODE is disengaged. (OSD > **Burn In Off**)

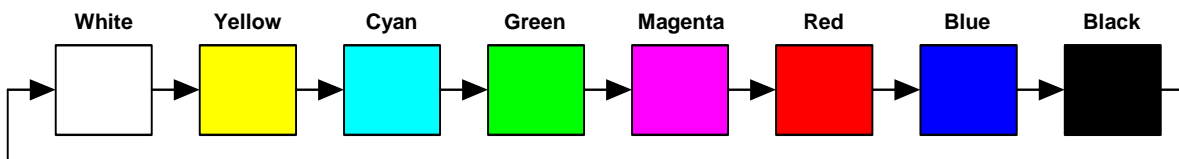

SERVICE MODE ACCESS

DEMO MODE

DEMO MODE

When the DEMO feature is turned ON, both the remote and the plasma panel front panel buttons (with the exception of the SUB POWER button) are non-operational. This can be useful for the Sales / Dealers to prevent anyone from playing with any of the settings.

NOTE: This is the front panel shortcut to parameter #175 in the I2C ADJUSTMENT MODE.

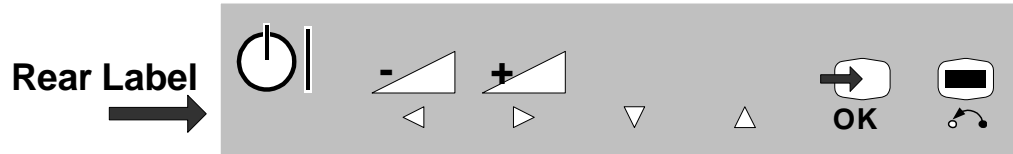

- 1. SUB POWER
- 2. VOL ▼
- 2. ADJ ◀
- 3. VOL ▲
- 3. ADJ ▶
- 4. PROGRAM ▼
- 4. SELECT ▼
- 5. PROGRAM ▲
- 5. SELECT ▲
- 6. INPUT SELECT
- 6. OK
- 7. MENU

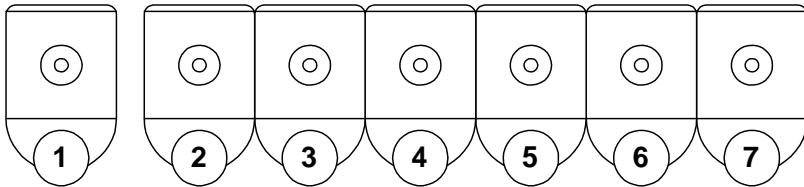

NOTE:
 1st number indicates normal button operation
 2nd number indicates function during MENU

DEMO MODE (ON)

With unit in standby mode (turned off), press and hold: >

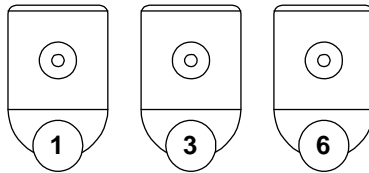

After the unit comes on, continue to hold the buttons down until the initial OSD goes away. **DEMO MODE** is now engaged, although you will not see any OSD confirmation.

DEMO MODE (OFF)

With unit in standby mode (turned off), press and hold: >

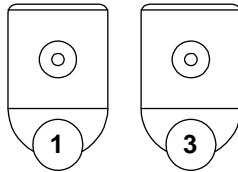

After the unit comes on, continue to hold the buttons down until the initial OSD goes away. **DEMO MODE** is now disengaged, although you will not see any OSD confirmation.

SERVICE MODE ACCESS

I2C ADJUSTMENT MODE

I²C ADJUSTMENT MODE

When the set is in the I2C Adjustment mode, use the cursor buttons ▼ ▲ for selecting the adjustment parameter, and ◀ ▶ for changing the parameter's value. Use the **OK** button to confirm. After adjustments are complete, press the **MENU** button to return the set to normal operating condition.

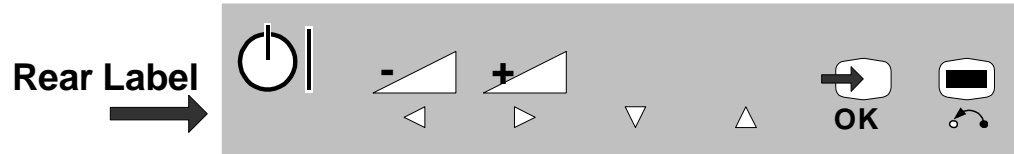

1. SUB POWER

2. VOL ▼

2. ADJ ◀

3. VOL ▲

3. ADJ ▶

4. PROGRAM ▼

4. SELECT ▼

5. PROGRAM ▲

5. SELECT ▲

6. INPUT SELECT

6. OK

7. MENU

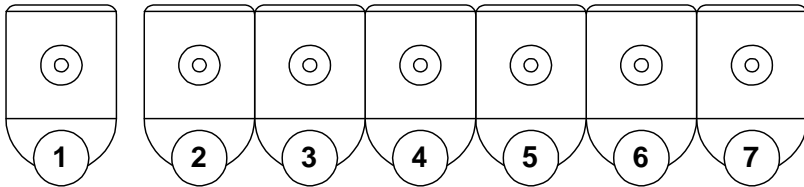

NOTE:

1st number indicates normal button operation

2nd number indicates function during MENU

I2C Adjustment Mode

With unit in standby mode (turned off), press and hold: >

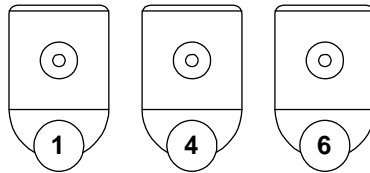

After the unit comes on, continue to hold the buttons down until the initial OSD goes away. OSD will then appear indicating that **I2C ADJUSTMENT MODE** is engaged.

MEMORY INITIALIZATION

Don't indiscriminately perform this procedure as it can result in a loss of data if the old values were not recorded.

1. Engage I2C Adjustment mode.
2. Select parameter #744. Change the data value from "0" to "1".
3. Activate MEMORY INITIALIZATION by holding down the **OK** button for at least three seconds.
4. Select parameter #374. Change the data value from "1" to "0".
5. Check that the set changes input to AV1, indicating that the preset values have been loaded.

SERVICE MODE ACCESS

FACTORY RESET

FACTORY RESET

Occasionally, it becomes necessary to perform a factory reset. This is different than the Memory Initialization, only customer settings are affected by Factory Reset.

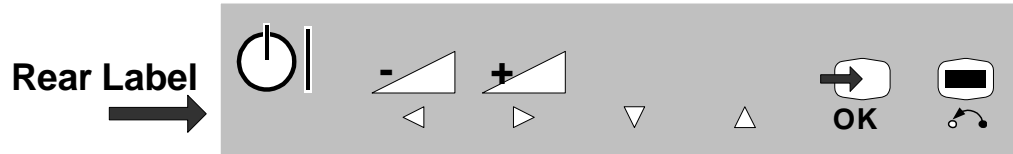

1. SUB POWER
2. VOL ▼
2. ADJ ◀
3. VOL ▲
3. ADJ ▶
4. PROGRAM ▼
4. SELECT ▼
5. PROGRAM ▲
5. SELECT ▲
6. INPUT SELECT
6. OK
7. MENU

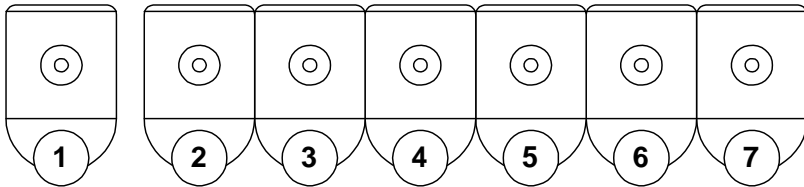

NOTE:
 1st number indicates normal button operation
 2nd number indicates function during MENU

Factory Reset

With unit in standby mode (turned off), press and hold: >

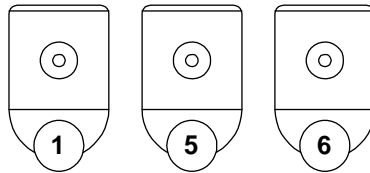

After the unit comes on, continue to hold the buttons down until the initial OSD goes away. **Factory Reset** has now engaged, although you will not see any OSD confirmation.

SERVICE MODE ACCESS

DIAGNOSIS MODE

DIAGNOSIS MODE

This chassis has a limited self-diagnosis mode. When activated, the microprocessor generates a series of internal communication checks and outputs the results via OSD, as seen on the table below. Since it uses the OSD to display the results, any circuit failures which result in a “no display” or “no picture” condition will not be able to be seen, obviously. ANY operation (volume, channel, menu, input, etc.) will cause the unit to exit from the Diagnosis mode.

Diagnosis Mode

With unit in standby mode (turned off), press and hold: >

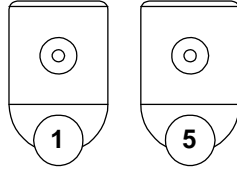

After the unit comes on, continue to hold the buttons down until the initial OSD goes away. OSD will then appear indicating that the **DIAGNOSIS MODE** is engaged.

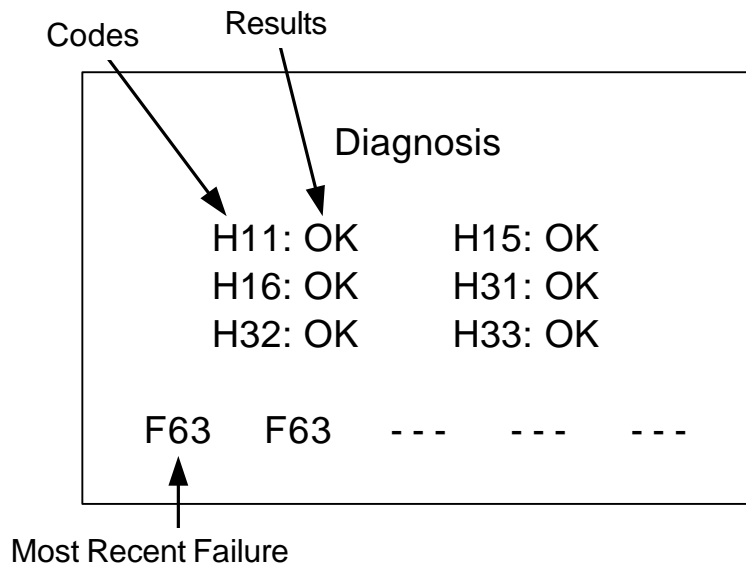

Code	Problem	Phenomenon	Cause
H11*	Tuner problem	Can not receive the main signal from antenna	U101 error
H15	Composite video SW IC problem	Can not receive picture and audio - can not change input mode	I201 error
H16	Component video SW IC problem	No component picture - can not change input mode	I202 error
H31	Color Demodulator IC problem	Abnormal color - dark picture	I501 error
H32	Sync separator IC problem	Unsynchronized picture	I601 error
H33	3D Y/C separator problem	Abnormal color - dark picture/no picture	I302 error
F63	I2C Bus latch problem	Can't store data settings	SDA3/SCL3 latched up
* Only with units having a tuner circuit			

CMP420V1/CMP420V2/42EDT41 (PW1A)

● **Service adjustment items by I²C-bus control**

O : Should be adjusted
 Δ : Should be followed previous data

Adj. No.	Function		Maximum Value	Default	Changed Component			
	Adjust Items	Mode			Formatter PWB	VIDEO PWB	TUNER PWB	PDP PANEL
0	R DRIVE1 [TV/VIDEO/DSUB-COMP]	COOL	255	224	Δ			O
1	G DRIVE1 [TV/VIDEO/DSUB-COMP]	COOL	255	224	Δ			O
2	B DRIVE1 [TV/VIDEO/DSUB-COMP]	COOL	255	224	Δ			O
3	R DRIVE2 [TV/VIDEO/DSUB-COMP]	NORMAL	255	224	Δ			O
4	G DRIVE2 [TV/VIDEO/DSUB-COMP]	NORMAL	255	224	Δ			O
5	B DRIVE2 [TV/VIDEO/DSUB-COMP]	NORMAL	255	224	Δ			O
6	R DRIVE3 [TV/VIDEO/DSUB-COMP]	WARM	255	224	Δ			O
7	G DRIVE3 [TV/VIDEO/DSUB-COMP]	WARM	255	224	Δ			O
8	B DRIVE3 [TV/VIDEO/DSUB-COMP]	WARM	255	224	Δ			O
9	R DRIVE4 [TV/VIDEO/DSUB-COMP]	BLACK & WHITE	255	224	Δ			O
10	G DRIVE4 [TV/VIDEO/DSUB-COMP]	BLACK & WHITE	255	224	Δ			O
11	B DRIVE4 [TV/VIDEO/DSUB-COMP]	BLACK & WHITE	255	224	Δ			O
12	R DRIVE1 [DVI-PC/DVI-STB/DSUB-RGB]	COOL	255	224	Δ			O
13	G DRIVE1 [DVI-PC/DVI-STB/DSUB-RGB]	COOL	255	224	Δ			O
14	B DRIVE1 [DVI-PC/DVI-STB/DSUB-RGB]	COOL	255	224	Δ			O
15	R DRIVE2 [DVI-PC/DVI-STB/DSUB-RGB]	NORMAL	255	224	Δ			O
16	G DRIVE2 [DVI-PC/DVI-STB/DSUB-RGB]	NORMAL	255	224	Δ			O
17	B DRIVE2 [DVI-PC/DVI-STB/DSUB-RGB]	NORMAL	255	224	Δ			O
18	R DRIVE3 [DVI-PC/DVI-STB/DSUB-RGB]	WARM	255	224	Δ			O
19	G DRIVE3 [DVI-PC/DVI-STB/DSUB-RGB]	WARM	255	224	Δ			O
20	B DRIVE3 [DVI-PC/DVI-STB/DSUB-RGB]	WARM	255	224	Δ			O
21	R DRIVE4 [DVI-PC/DVI-STB/DSUB-RGB]	BLACK & WHITE	255	224	Δ			O
22	G DRIVE4 [DVI-PC/DVI-STB/DSUB-RGB]	BLACK & WHITE	255	224	Δ			O
23	B DRIVE4 [DVI-PC/DVI-STB/DSUB-RGB]	BLACK & WHITE	255	224	Δ			O
24	Black Level(RGB_AMP)	TV/VIDEO	254	127				
25	Black Level(RGB_AMP)	PC	254	127				
26	Reference Amplitude(RGB_AMP)	TV/VIDEO	254	127				
27	Reference Amplitude(RGB_AMP)	PC	254	127				
28	Display for Max. Amplitude Level	Main	-	-				
29	Display for Max. Amplitude Level	SUB	-	-				
30	SUB_CONTRAST(RF)	MAIN	15	7				
31	SUB_CONTRAST (AV1)	MAIN/SUB COMPOSITE mode	15	7				
32	SUB_CONTRAST(RF)	SUB	15	7				
33	SUB_CONTRAST (AV4)	MAIN/SUB COMPOSITE mode	15	7				
34	SUB_COLOR(VIDEO-PAL/SECAM)	MAIN	15	10				
35	SUB_COLOR(RF-PAL/SECAM)	MAIN	3	8				
36	SUB_COLOR(VIDEO-NTSC)	MAIN	15	10				
37	SUB_COLOR(RF-NTSC)	MAIN	15	6				
38	SUB_COLOR(VIDEO-PAL/SECAM)	SUB	15	10				
39	SUB_COLOR(RF-PAL/SECAM)	SUB	3	8				
40	SUB_COLOR(VIDEO-NTSC)	SUB	15	10				
41	SUB_COLOR(RF-NTSC)	SUB	15	8				
42	TINT(VIDEO)	MAIN	63	33	Δ	O		
43	TINT(RF)	MAIN	63	33	Δ	O		
44	TINT(VIDEO)	SUB	63	33	Δ	O		
45	TINT(RF)	SUB	63	33	Δ	O		
46	S_B-Y_ADJ	MAIN	15	8				
47	S_R-Y_ADJ	MAIN	15	8				
48	S_B-Y_ADJ	SUB	15	8				
49	S_R-Y_ADJ	SUB	15	8				
50	BPF_Q (4.43MHz)	MAIN	3	3				
51	BPF_f0 (4.43MHz)	MAIN	3	1				
52	Y_DL (4.5MHz) For Asia	MAIN	10	5				
53	Y_DL (5.5MHz PAL/NTSC4.43) For Asia	MAIN	10	3				
54	Y_DL (5.5MHz SECAM) For Asia	MAIN	10	0				
55	Y_DL (6.0PAL/NTSC4.43) For Asia	MAIN	10	9				
56	Y_DL (6.0SECAM) For Asia	MAIN	10	9				
57	Y_DL (VIDEO PAL/NTSC4.43)	MAIN	10	6				
58	Y_DL (VIDEO SECAM)	MAIN	10	8				
59	Y_DL (VIDEO NTSC)	MAIN	10	6				
60	BELL_f0	MAIN	1	0				
61	Y_OUT_LEVEL (VIDEO)	MAIN	63	13				
62	Initialize function for EEPROM of Video PWB board		1	0				
63	Y_OUT_LEVEL (TEXT)	MAIN	63	0				
64	C_OUT_LEVEL (VIDEO)	MAIN	63	7				
65	Check condition of EEPROM of Video PWB board	0:Normal, 1:Abnormal(Fail or no assembly)	1	-				
66	C_OUT_LEVEL (TEXT)	MAIN	63	0				
67	Y_OUT_LEVEL (TEXT)	SUB	63	12				

CMP420V1/CMP420V2/42EDT41 (PW1A)

○ : Should be adjusted
△ : Should be followed previous data

Adj. No.	Function		Maximum Value	Default	Changed Component			
					Formatter PWB	VIDEO PWB	TUNER PWB	PDP PANEL
	Adjust Items	Mode						
68	Y_OUT_LEVEL (VIDEO)	SUB	63	13				
69	Dispersion Time of Sustain current 0: 2 Times, 1: 4 times	For Dynamic (Day) mode	1	0				
70	C_OUT_LEVEL (TEXT)	SUB	63	7				
71	C_OUT_LEVEL (VIDEO)	SUB	63	7				
72	Dispersion Time of Sustain current 0: 2 Times, 1: 4 times	For Natural (Night) mode	1	1				
73	BPF_Q (4.43MHz)	SUB	3	3				
74	BPF_f0 (4.43MHz)	SUB	3	1				
75	Y_DL (4.5MHz) For Asia	SUB	10	5				
76	Y_DL (5.5MHz PAL/NTSC4.43) For Asia	SUB	10	2				
77	Y_DL (5.5MHz SECAM) For Asia	SUB	10	0				
78	Y_DL (6.0PAL/NTSC4.43) For Asia	SUB	10	7				
79	Y_DL (6.0SECAM) For Asia	SUB	10	10				
80	Y_DL (VIDEO PAL/NTSC4.43)	SUB	10	8				
81	Y_DL (VIDEO SECAM)	SUB	10	6				
82	Y_DL (VIDEO NTSC)	SUB	10	5				
83	BELL_f0	SUB	1	0				
84	C_TRAP_SW (COMB=OFF-PAL/NTSC4.43/NTSC3.58)	MAIN	1	0				
85	C_TRAP_SW (COMB=OFF-PAL/NTSC4.43/NTSC3.58)	SUB	1	0				
86	MVM(VIDEO)	-	1	0				
87	AFC_GAIN (AV00)	-	3	0				
88	AFC_GAIN (AV1)	-	3	0				
89	AFC_GAIN (AV2)	-	3	0				
90	AFC_GAIN (AV3)	-	3	0				
91	AFC_GAIN (AV4)	-	3	0				
92	S_INHBT	-	1	0				
93	S_ID	-	1	0				
94	S_GP	-	3	0				
95	S_V_ID	-	1	0				
96	BELL/HPF	-	3	3				
97	Cb offset1	MAIN	15	8				
98	Cr offset1	MAIN	15	8				
99	Cb offset1	SUB	15	8				
100	Cr offset1	SUB	15	8				
101	Sharpness Gain(VIDEO) PAL	MAIN	15	10				
102	Sharpness Gain(RF)	MAIN	5	8				
103	Sharpness EQ(4.5MHz)	MAIN	3	1				
104	Sharpness EQ(5.5MHz)	MAIN	3	1				
105	Sharpness EQ(6.0/6.5MHz)	MAIN	3	1				
106	Sharpness EQ(VIDEO)	MAIN	3	1				
107	Sharpness f0(VIDEO) PAL	MAIN	3	2				
108	Sharpness f0(RF)	MAIN	3	2				
109	Sharpness Gain(VIDEO) PAL	SUB	15	9				
110	Sharpness Gain(RF)	SUB	5	10				
111	Sharpness EQ(4.5MHz)	SUB	3	1				
112	Sharpness EQ(5.5MHz)	SUB	3	1				
113	Sharpness EQ(6.0/6.5MHz)	SUB	3	1				
114	Sharpness EQ(VIDEO)	SUB	3	1				
115	Sharpness f0(VIDEO) PAL	SUB	3	2				
116	Sharpness f0(RF)	SUB	3	2				
117	LPF	MAIN	1	0				
118	LPF	SUB	1	0				
119	SECAM D-Trap	MAIN/SUB	1	1				
120	FILTER SW(RF)	MAIN	1	0				
121	FILTER SW(RF)	SUB	1	0				
122	NTSC Comb(Comb off)	SUB	1	1				
123	HS Phase	MAIN	1	0				
124	HS Phase	SUB	1	0				
125	P/N ID	MAIN	1	0				
126	P/N ID	SUB	1	0				
127	Y/C_SEP_MODE (COMB=OFF-PAL)	-	3	0				
128	Y-Pf0	-	1	0				
129	Y-EQ_GAIN	-	3	2				
130	Y-EQ/N.C_LIM	-	3	0				
131	Y-LPF	-	1	0				
132	V-EMPH_GAIN	-	7	3				
133	V-EMPH_N.L	-	7	3				
134	V-EMPH_CORE	-	3	1				
135	D RANGE	-	1	0				
136	DY_GAIN	MAIN NTSC mode	15	9				

CMP420V1/CMP420V2/42EDT41 (PW1A)

O : Should be adjusted
 Δ : Should be followed previous data

Adj. No.	Function		Maximum Value	Default	Changed Component			
	Adjust Items	Mode			Formatter PWB	VIDEO PWB	TUNER PWB	PDP PANEL
137	DC_GAIN	MAIN NTSC mode	15	6				
138	VAP_GAIN	MAIN NTSC mode	7	5				
139	VAP_INV	MAIN NTSC mode	31	10				
140	YH_CORE	MAIN NTSC mode	3	0				
141	YHCGAIN	MAIN NTSC mode	1	1				
142	CDL	MAIN NTSC mode	7	3				
143	YNRK	MAIN NTSC mode	1	1				
144	YNRINV	MAIN NTSC mode	1	0				
145	YNRLIM	MAIN NTSC mode	3	1				
146	CNRK		1	1				
147	CNRINV		1	0				
148	CNRLIM		3	1				
149	YPPG		15	10				
150	SEPA_LEVEL	480i/576i	3	2				
151	SEPA_LEVEL	480p/576p	3	2				
152	SEPA_LEVEL	1080i_50	3	2				
153	SEPA_LEVEL	1080i_60/720p	3	2				
154	AUTO_FM/AM(D11-D8)	-	15	2				
155	AUTO_FM/AM(D7-D0)	-	254	189				
156	A2_THRESHOLD(D11-D8)	-	15	0				
157	A2_THRESHOLD(D7-D0)	-	254	112				
158	PRE_AM	Except 4.5MHz (Except Dual/Stereo mode)	254	17				
159	VOL_SCART1 (D15-D8)	-	254	115				
160	VOL_SCART1 (D7-D5)	-	7	0				
161	PRE_SCART	-	254	31				
162	PRE_FM	4.5MHz(JAPAN)	254	34				
163	PRE_FM	4.5MHz(Except BTSC-SAP mode)	254	32				
164	PRE_FM	4.5MHz(BTSC-SAP)	254	60				
165	PRE_FM	4.5MHz(Except KOREA-Dual/Stereo mode)	254	19				
166	PRE_FM	4.5MHz(KOREA-Dual/Stereo)	254	34				
167	PRE_FM	Except 4.5MHz(Except Dual/Stereo mode)	254	17				
168	PRE_FM	Except 4.5MHz(Dual/Stereo mode)	254	27				
169	PRE_NICAM	-	254	57				
170	Screen Saver-Picture shift amount 0:1pixel 1:2pixel 2:3pixel		2	0				
171	Thermo sensor function available or not 0 : None, 1 : Yes		1	0				
172	Video Input function available or not at RGB1 & RGB2 mode	0 : Not available, 1 : Available	1	1				
173	Screen Saver-Picture shift direction 0:dia 1:cross 2:up/down 3:left/right		3	0				
174	AUDIO Function available 0:No , 1:Yes		1	1				
175	Remote Function available 0:No , 1:Yes		1	1				
176	Power Save On/Off Setting at Initialize,Reset and Shipping	0:Change 1: Don't Change	2	0				
177	DVI-STB/RGB-COMPONENT Function available 0 : NO, 1 : YES		1	0				
178	Dynamic Backlight function 0:No, 1:Yes	For LCD model	1	1				
179	ISM Control for WVGA		1	1				
180	Terminal Mode Function available 0:Not Available, 1:Available	RS232C	1	0				
181	Black insert function 0:Not available, 1:Available	For Dynamic mode or Day mode (For LCD model only)	1	0				
182	AGC_LEVEL AGCL	ALL Mode	3	0				
183	TEXT H sync delay	-	127	0				
184	TEXT V sync delay	-	127	50				
185	TEXT_H_POSITION	-	254	42				
186	TEXT_V_POSITION	-	254	38				
187	Lower Limits value for Sync Detect of 2ms interval	For AFC at TV mode	254	25				
188	Upper Limits Value for Sync Detect of 2ms interval	For AFC at TV mode	254	40				
189	Lower Limits value for Sync Detect of 2ms interval	For Free Running at TV mode	254	30				
190	Upper Limits Value for Sync Detect of 2ms interval	For Free Running at TV mode	254	45				
191	Lower Limits value for Sync Detect of 2ms interval	For AUTO OFF at TV mode	254	25				
192	Upper Limits Value for Sync Detect of 2ms interval	For AUTO OFF at TV mode	254	35				
193	Lower Limits value for Sync Detect of 2ms interval	For Free Running at AV mode	254	30				
194	Upper Limits Value for Sync Detect of 2ms interval	For Free Running at AV mode	254	45				
195	Counting time for discrimination of fv	-	31	2				
196	Dispersion Time of Sustain current 0: 2 Times, 1: 4 times	For PC mode	1	1				
197	Counting time for discrimination of SYNC	-	31	2				
198	Input Source of fv/fH judgment(0:M30625/TA1370)	Component Mode	1	0				
199	Counting time for discrimination of fv(M30625/TA1370)	-	31	2				
200	Y_DL (6.5MHz PAL/NTSC4.43) For Asia	Main	10	7				
201	Y_DL (6.5MHz SECAM) For Asia	Main	10	10				
202	Y_DL (6.5MHz PAL/NTSC4.43) For Asia	Sub	10	4				
203	Y_DL (6.5MHz SECAM) For Asia	Sub	10	10				
204	PDP-BLK ON/OFF	1:ON, 0:OFF	1	0				
205	Counting time for discrimination of fh(M30625/TA1370)	-	31	2				

CMP420V1/CMP420V2/42EDT41 (PW1A)

○ : Should be adjusted
△ : Should be followed previous data

Adj. No.	Function		Maximum Value	Default	Changed Component			
	Adjust Items	Mode			Formatter PWB	VIDEO PWB	TUNER PWB	PDP PANEL
206	Sharpness f0(L)	Sub	3	2				
207	NJW1320_OUT1_GAIN	VIDEO PWB	1	0				
208	NJW1320_OUT2_GAIN	VIDEO PWB	1	0				
209	Sharpness f0(L')	Sub	3	2				
210	AFC_GAIN (Except AV00 mode)	Except AV00 mode	3	0				
211	Recovery to an error of OSC frequency of Ceramic resonator for timer		62	34				
212	Brightness Center (CM)	NT2/NT3/HD2/HD3/PAL2/PAL3/HD9/HD10/NT4/PAL4	254	128				
213	Brightness Center (CM)	HD1/HD4/HD5/HD6/HD7/HD8	254	128				
214	Brightness Center (CM)	MULTI PICTURE/NT1/PAL1	254	128				
215	Reset function of accumulation time for WVGA/LCD Panel	0:Normal 1:Reset	1	0				
216	Contrast Center (CM) Except WVGA & LCD	TV/VIDEO(AV3/AV4 mode)	254	137				
217	Power key function available or not (At Force AVC mode)	0:Available 1:Cannot	1	0				
218	Color Center (CM)	NT1/NT2/NT4/HD3/HD4/HD6/PAL4	127	85				
219	Color Center (CM)	PAL1/PAL2/HD8/HD9	127	85				
220	Color Center (CM)	NT3/HD1/HD2/HD5/PAL3/HD7/HD10	127	85				
221	Tint Center (CM)	PAL1	254	120				
222	Tint Center (CM)	NT1/NT2/NT4/HD3/HD4/HD6	254	113				
223	Tint Center (CM)	PAL2/HD8/HD10/PAL4	254	108				
224	Tint Center (CM)	NT3/HD1/HD2/HD5/PAL3/HD7/HD9	254	124				
225	Center of Sharpness (HV Enhancer Gain for Y) For Europe	TV	31	19				
226	Center of Sharpness (HV Enhancer Gain for Y) For Europe	VIDEO	31	18				
227	Center of Sharpness (HV Enhancer Gain for Y) For Europe	HD5/HD6	31	11				
228	Center of Sharpness (HV Enhancer Gain for Y) For Europe	HD1/HD4/HD7/HD8	31	7				
229	Center of Sharpness (HV Enhancer Gain for Y) For Europe	HD2/HD3/HD9/HD10	31	15				
230	Center of Sharpness (HV Enhancer Gain for Y) For Europe	NT2/NT3/PAL2/PAL3/NT4/PAL4	31	15				
231	Center of Sharpness (HV Enhancer Gain for Y) For Europe	TEXT(for split)	31	7				
232	Maximum Value of Contrast at REAL/NORMAL mode		254	188				
233	Offset Value of Contrast data at SPLIT mode		120	83				
234	Offset value of gain for Black Stretch function	Except OFF/LOW/HIGH mode	63	33				
235	Demonstration [White] 0-3:None,4:0,5:+10W,6:+20W,7:+30W	Mode(common)	7	5				
236	Demonstration 0:Normal, 1:Peak	Mode	1	1				
237	Demonstration [Middle] 0:+0W,1:+10W,2:+20W,3:+30W	Mode(common)	3	3				
238	Demonstration 0:Normal, 1:Peak	Mode	1	0				
239	Horizontal Enhance	TEXT	3	3				
240	YNR Input Level at Low level for DVI-STV Mode	1080i-60/1080i-50/720p-60	7	2				
241	YNR Input Level at Low level for DVI-STV Mode	480i/480p/576i/576p/VGA	7	2				
242	CNR Input Level at Low level for DVI-STV Mode	1080i-60/1080i-50/720p-60	7	2				
243	CNR Input Level at Low level for DVI-STV Mode	480i/480p/576i/576p/VGA	7	2				
244	Vertical Enhance	TEXT	3	3				
245	Demonstration Mode 0:(Off), 1:(On)		1	0				
246	WVGA sys_state	For WVGA	1	0				
247	WVGA BRIGHTNESS	For WVGA	1	0				
248	Enhancer gain of VH for C	TEXT	31	0				
249	YNR(NR) Input Level	RF Mode	7	3				
250	YNR Input Level at Low level for AV1-4 Mode	VIDEO	7	3				
251	YNR Input Level at Low level for AV1-4 Mode	NT2/NT3/PAL2/PAL3/NT4/PAL4	7	3				
252	YNR Input Level at Low level for AV1-4 Mode	HD1/HD4/HD5/HD6/HD7/HD8	7	3				
253	YNR Input Level at Low level for AV1-4 Mode	HD2/HD3/HD9/HD10	7	3				
254	CNR Input Level at Low level for AV1-4 Mode	VIDEO	7	3				
255	CNR Input Level at Low level for AV1-4 Mode	NT2/NT3/PAL2/PAL3/NT4/PAL4	7	3				
256	CNR Input Level at Low level for AV1-4 Mode	HD1/HD4/HD5/HD6/HD7/HD8	7	3				
257	CNR Input Level at Low level for AV1-4 Mode	HD2/HD3/HD9/HD10	7	3				
258	Heat APC function (HAPC) available		1	1				
259	yselect(0:1.0 1:2.2 2:2.8)	TV/VIDEO	2	1				
260	yselect(0:1.0 1:2.2 2:2.8)	DVI-PC/DVI-STB/DSUB-RGB	2	1				
261	Select for APC function		1	0				
262	"CCFMD" function	TV/VIDEO	1	0				
263	"CCFMD" function	DVI-PC/DVI-STB/DSUB-RGB	1	0				
264	NTSC/EBU(CCFORM)	NT1/NT2/HD3/HD4/HD6/HD8/HD10/PAL1/PAL2	1	0				
265	NTSC/EBU(CCFORM)	TV/VIDEO/NT3,4/PAL3,4/HD1,2,5,7,9	1	0				
266	NTSC/EBU(CCFORM)	DVI-PC/DVI-STB/DSUB-RGB	1	0				
267	Correction for Tracking (DCBON)	TV/VIDEO-Color Temp. : COOL	1	0				
268	Correction for Tracking (DCBON)	TV/AV-Col. Temp. : Nor/War	1	1				
269	Correction for Tracking (DCBON)	DVI-PC/DVI-STB/DSUB-RGB	1	1				
270	Color Temp. Correction		3	2				
271	Typical Value of Contrast OSD	DYNAMIC	31	31				
272	PC Power Save function (0:Impossible 1:Possible)		1	1				
273	Waite Time for POWER SAVE function (s)	VIDEO/PC	254	15				
274	Lower Limits value for Sync Detect of 2ms interval	For Power Save at AV mode	254	5				

CMP420V1/CMP420V2/42EDT41 (PW1A)

○ : Should be adjusted
△ : Should be followed previous data

Adj. No.	Function		Maximum Value	Default	Changed Component			
	Adjust Items	Mode			Formatter PWB	VIDEO PWB	TUNER PWB	PDP PANEL
275	Upper Limits Value for Sync Detect of 2ms interval	For Power Save at AV mode	254	200				
276	Horizontal Position of OSD	60Hz	15	7				
277	Vertical Position of OSD	60Hz	15	7				
278	PinP Function 0:PinP, 1:Infomation1, 2:Infomaiton Split		2	0				
279	Select for WIDE Mode		1	1				
280	Temperature for Fun start (Temp_High)		254	58				
281	Temperature for Fun stop (Temp_Low)		254	55				
282	Display of internal temperature °C(Temperature)		125	-				
283	Display of Panel map version		255	-				
284	accumulation time for Panel (hours)		65535	-				
285	Initialize function 0:Keep data, 1:Initialize	No.0-No.23,30-33,42-45,289,293,294,741-743	1	-				
286	L standard PLL gating HIGH [Europe model]		1	0				
287	Select for APC output [Except Europe model]	Main FE	2	1				
288	Q mode 0:Freeze, 1:Move 1, 2:Move 2	50Hz	2	1				
289	AGC adjustment (MFE) [Except Europe model]	MAIN	63	50	△		○	
290	AGC adjustment (MFE) [Europe model]	MAIN	63	20				
291	AGC INPUT(MFE)	MAIN	-	-				
292	Q mode 0:Freeze, 1:Move 1, 2:Move 2	70Hz(PC)	2	0				
293	SUB CONTRAST AV2	MAIN/SUB COMPOSITE mode	15	8				
294	SUB CONTRAST AV3	MAIN/SUB COMPOSITE mode	15	8				
295	Contrast Center (CM) Except WVGA & LCD	AV2	254	137				
296	Contrast Center (CM) Except WVGA & LCD	AV1	254	137				
297	Brightness center (CM) offset	AV2	254	127				
298	Brightness center (CM) offset	AV1	254	127				
299	Q mode 0:Freeze, 1:Move 1, 2:Move 2	60Hz	2	1				
300	3D ON/OFF 0:ON, 1:OFF(Through)		1	0				
301	Input Select of TA1370 0:HD1/VD1, 1:HD3/VD3	Main/Sub	1	0				
302	Sharpness Gain(RF/NR)	Main/Sub	15	3				
303	3Line Y/C Main- Sub SW	0:Main, 1: Sub	1	0				
304	Offset Value(+/-) of Upper Limit (for TB1274:SUB-CONT)	Single Picture mode	18	2				
305	Offset Value(+/-) of Upper Limit (for FC :RGB-AMP)	Multi Picture mode	18	2				
306	Reference Amplitude(RGB_AMP)	Multi Picture mode	254	90				
307	Component Frq.(fH) Setup (0:28/31/33/45KHz,1:28/31/45KHz)		1	0				
308	Target value of White peak Adj.	Single Picture mode	237	235				
309	Sharpness Gain(S VIDEO)	Main	15	7				
310	Sharpness Gain(S VIDEO)	Sub	15	7				
311	Select color control (0: Asia, 1: South America)	Main/Sub	1	0				
312	Sharpness Gain Main(N-PAL)		15	8				
313	Sharpness f0 Main(N-PAL)		3	2				
314	Sharpness Gain Sub (N-PAL)		15	9				
315	Sharpness f0 Sub (N-PAL)		3	2				
316	Delay Time ON/OFF for Lipsync circuit 0:Off, 1:On		1	1				
317	Sync Mode SW		7	0				
318	Set Sound System at Auto mode of Sound Sys. (0:auto,1:4.5MHz)	Main	1	0				
319	Power condition at power save mode of PC mode after done RESET function	0:Keep last condition, 1:Return to normal condition	1	0				
320	Switch to North USA model from Europe software. OSD change (Wide Mode...)	0:For Europe, 1:Foe USA (DAY/NIGHT,...)	1	0				
321	Count Source for ON/OFF Timer	0:MCU-250ms, 1:AC-50/60Hz	1	0				
322	Select Wide mode for Europe model (Normal= 5mode/ For Service= 10 mode)	0:Normal, 1:For service	1	0				
323	Forced AVC type available	0:Normal type , 1: Forced AVC type	1	0				
324	Sharpness Gain Main(M-PAL)		15	8				
325	Sharpness f0 Main(M-PAL)		3	2				
326	Sharpness Gain Sub (M-PAL)		15	9				
327	Sharpness f0 Sub (M-PAL)		3	2				
328	CNR Input Level at Low level for Dsub Comp. Mode	NT2/NT3/PAL2/PAL3/NT4/PAL4	7	2				
329	CNR Input Level at Low level for Dsub Comp. Mode	HD1/HD4/HD5/HD6/HD7/HD8	7	2				
330	CNR Input Level at Low level for Dsub Comp. Mode	HD2/HD3/HD9/HD10	7	2				
331	Sharpness Gain(VIDEO) NTSC3.58	MAIN	15	12				
332	Sharpness f0(VIDEO) NTSC3.58	MAIN	3	2				
333	Sharpness Gain(VIDEO) NTSC3.58	SUB	15	10				
334	Sharpness f0(VIDEO) NTSC3.58	SUB	3	2				
335	Sharpness Gain(VIDEO) SECAM,B/W	MAIN	15	10				
336	Sharpness f0(VIDEO) SECAM,B/W	MAIN	3	2				
337	Sharpness Gain(VIDEO) SECAM,B/W	SUB	15	8				
338	Sharpness f0(VIDEO) SECAM,B/W	SUB	3	2				
339	Sharpness Gain(VIDEO) NTSC4.43	MAIN	15	9				
340	Sharpness f0(VIDEO) NTSC4.43	MAIN	3	2				
341	Sharpness Gain(VIDEO) NTSC4.43	SUB	15	8				
342	Sharpness f0(VIDEO) NTSC4.43	SUB	3	2				
343	Brightness Limited Function of PANEL [APSON]		1	1				

CMP420V1/CMP420V2/42EDT41 (PW1A)

○ : Should be adjusted
△ : Should be followed previous data

Adj. No.	Function		Maximum Value	Default	Changed Component			
	Adjust Items	Mode			Formatter PWB	VIDEO PWB	TUNER PWB	PDP PANEL
344	VsVa WAIT TIMER [RISTIM]		15	5				
345	Initial value of Contrast	Panel life -Extend1	127	93				
346	Interval time of correction time	Panel life -Extend1	127	10				
347	Additional value of Contrast	Panel life -Extend1	127	1				
348	Initial value of Contrast	Panel life -Extend2	127	63				
349	Interval time of correction time	Panel life -Extend2	127	6				
350	Additional value of Contrast	Panel life -Extend2	127	1				
351	L_PLL.GAIN		1	0				
352	AS[YHECLPL0_P0]	RF/Multi	15	2				
353	AS[YHECLPL1_P0]	NT1-except RF/PAL1-except RF	15	2				
354	[YHECLPL2_P0]	HD	15	1				
355	AS[YHECLPL3_P0]	NT2,3,4/PAL2,3,4	15	10				
356	SEPA_LEVEL_DSUB	480i/576i	3	2				
357	SEPA_LEVEL_DSUB	480p/576p	3	2				
358	SEPA_LEVEL_DSUB	1080i_50	3	2				
359	SEPA_LEVEL_DSUB	1080i_60/720p	3	2				
360	HD-PHASE_DSUB	480i/576i	63	20				
361	HD-PHASE_DSUB	480p/576p	63	20				
362	HD-PHASE_DSUB	1080i_50	63	20				
363	HD-PHASE_DSUB	1080i_60/720p	63	20				
364	Y_DL (L)	MAIN	10	4				
365	Y_DL (L')	MAIN	10	4				
366	Y_DL (L)	Sub	10	1				
367	Y_DL (L')	Sub	10	1				
368	Sharpness Gain(L)	MAIN	15	10				
369	Sharpness Gain(L')	MAIN	15	10				
370	Sharpness Gain(L)	SUB	15	8				
371	Sharpness Gain(L')	SUB	15	8				
372	Sharpness f0(L)	MAIN	3	2				
373	Sharpness f0(L')	MAIN	3	2				
374	BURN-IN enable/ disenable	0:Disenable, 1:Enable	1	1				
375	BURN-IN mode		2	2				
376	CM_THRESHOLD (D15-D8)	-	254	0				
377	CM_THRESHOLD (D7 -D0)	-	254	36				
378	Sharpness Gain(RF M)	MAIN	15	11				
379	Sharpness Gain(RF M)	Sub	15	11				
380	Sharpness f0 (RF M)	Main	3	2				
381	Sharpness f0 (RF M)	SUB	3	2				
382	Counting value of 2ms Sync.Detect	MAIN	-	-				
383	Counting value of 2ms Sync.Detect	SUB	-	-				
384	TB1274 Read Data(00h)	Main	-	-				
385	TB1274 Read Data(01h)	Main	-	-				
386	TB1274 Read Data(00h)	Sub	-	-				
387	TB1274 Read Data(01h)	Sub	-	-				
388	MSP Read Data (CNTROL) (D15-D8)		-	-				
389	MSP Read Data (CNTROL) (D7 -D0)		-	-				
390	MSP Read Data (STANDARD_RES) (D15-D8)		-	-				
391	MSP Read Data (STANDARD_RES) (D7 -D0)		-	-				
392	MSP Read Data (STATUS) (D15-D8)		-	-				
393	MSP Read Data (STATUS) (D7 -D0)		-	-				
394	TA1370G Read Data(00h)	Video board side	-	-				
395	TA1370G Read Data(01h)	Video board side	-	-				
396	TA1370G Read Data(00h)	Formater side	-	-				
397	TA1370G Read Data(01h)	Formater side	-	-				
398	uPD64084 Read Data(00H)		-	-				
399	uPD64084 Read Data(01h)		-	-				
400	Language (Refer to below)		6	0				
401	Hotel Mode(0:No,1:Yes)		1	0				
402	Analog Data (0:Keep EEPROM,1:Not Keep to EEPROM)		1	0				
403	Maximum Volume Limit		63	63				
404	Power Mode(0>Last mode, 1:Pos1, 2:V1, 3:V2, 4:V3, 5:V4)		5	0				
405	Channel Select(0:CCIR, 1:CHINA)		1	0				
406	Auto_sound 4.5 (0:Korea, 1:BTSC, 2:Japan)		2	0				
407	T/TEXT(0: None, 1:Yes)		1	1				
408	TEXT Language		7	0				
409	IIC BUS Data/Clock Open(0:Close, 1:Open)		1	0				
410	Channel Preset(0:VESTEL, 1:GIFU, 2:HAMA, 3:HFD,4:AUSTRALIA)		4	1				
411	Detect and Display Tele-Cinema (0:normal 1:Tele Cinema)		-	-				
412	V FREQ 60Hz Force (0:None, 1:Yes)	Main/Sub	1	0				

CMP420V1/CMP420V2/42EDT41 (PW1A)

○ : Should be adjusted
△ : Should be followed previous data

Adj. No.	Function		Maximum Value	Default	Changed Component			
	Adjust Items	Mode			Formatter PWB	VIDEO PWB	TUNER PWB	PDP PANEL
413	COLOR SYSTEM CONTROL-MODE(0:BW, 2:3.58NTSC, 3:4.43NTSC, ...)	Main	-	-				
414	COLOR SYSTEM CONTROL-MODE(0:BW, 2:3.58NTSC, 3:4.43NTSC, ...)	Sub	-	-				
415	Horizontal Filter SW [HHPF0]	NTSC	1	0				
416	Enhancer Gain [HHPF1]	PAL	1	0				
417	Enhancer Gain [HHPF2]	HD	1	0				
418	Horizontal Coring Level(Enhancer Gain) AS[HECOR0_PO]	NT1-RF	15	1				
419	Horizontal Coring Level(Enhancer Gain) AS[HECOR1_PO]	PAL1-RF/multi	15	1				
420	Horizontal Coring Level(Enhancer Gain) [HECOR2_PO]	NT1-Video	15	1				
421	Horizontal Coring Level(Enhancer Gain) [HECOR3_PO]	PAL1-Video	15	1				
422	Horizontal Coring Level(Enhancer Gain) [HECOR4_PO]	NT2/NT3/NT4/PAL2/PAL3/PAL4	15	0				
423	Horizontal Coring Level(Enhancer Gain) [HECOR5_PO]	HD2/HD3/HD9/HD10	15	1				
424	Horizontal Coring Level(Enhancer Gain) [HECOR6_PO]	HD1/HD4/HD5/HD6/HD7/HD8	15	0				
425	Horizontal Coring Level(Enhancer Gain) [HECORPC_PO]	PC	15	1				
426	Horizontal Coring Level(Enhancer Gain) EU[HECORE_PO]	PAL1-RF/multi	15	1				
427	Vertical Coring Level(Enhancer Gain) AS[VECOR0_PO]	NT1-RF	15	1				
428	Vertical Coring Level(Enhancer Gain) AS[VECOR1_PO]	PAL1-RF/multi	15	1				
429	Vertical Coring Level(Enhancer Gain) [VECOR2_PO]	NT1-Video	15	1				
430	Vertical Coring Level(Enhancer Gain) [VECOR3_PO]	PAL1-Video	15	1				
431	Vertical Coring Level(Enhancer Gain) [VECOR4_PO]	NT2/NT3/NT4/PAL2/PAL3/PAL4	15	0				
432	Vertical Coring Level(Enhancer Gain) [VECOR5_PO]	HD2/HD3/HD9/HD10	15	0				
433	Vertical Coring Level(Enhancer Gain) [VECOR6_PO]	HD1/HD4/HD5/HD6/HD7/HD8	15	0				
434	Vertical Coring Level(Enhancer Gain) [VECORPC_PO]	PC	15	0				
435	Vertical Coring Level(Enhancer Gain) EU[VECORE_PO]	PAL1-RF/multi	15	0				
436	Horizontal Coring Level(Enhancer Gain) AS[HECOR0_P1]	NT1-RF	15	1				
437	Horizontal Coring Level(Enhancer Gain) AS[HECOR0_P2]	PAL1-RF/multi	15	1				
438	Horizontal Coring Level(Enhancer Gain) [HECOR0_P3]	NT1-Video	15	1				
439	Horizontal Coring Level(Enhancer Gain) [HECOR0_P4]	PAL1-Video	15	1				
440	Horizontal Coring Level(Enhancer Gain) [HECOR0_P5]	NT2/NT3/NT4/PAL2/PAL3/PAL4	15	0				
441	Horizontal Coring Level(Enhancer Gain) [HECOR0_P6]	HD2/HD3/HD9/HD10	15	1				
442	Horizontal Coring Level(Enhancer Gain) [HECOR0_P7]	HD1/HD4/HD5/HD6/HD7/HD8	15	0				
443	Horizontal Coring Level(Enhancer Gain) [HECORPC_P1]	PC	15	1				
444	Horizontal Coring Level(Enhancer Gain) EU[HECORE_P1]	PAL1-RF/multi	15	1				
445	Vertical Coring Level(Enhancer Gain) AS[VECOR0_P1]	NT1-RF	15	1				
446	Vertical Coring Level(Enhancer Gain) AS[VECOR0_P2]	PAL1-RF/multi	15	1				
447	Vertical Coring Level(Enhancer Gain) [VECOR0_P3]	NT1-Video	15	1				
448	Vertical Coring Level(Enhancer Gain) [VECOR0_P4]	PAL1-Video	15	1				
449	Vertical Coring Level(Enhancer Gain) [VECOR0_P5]	NT2/NT3/NT4/PAL2/PAL3/PAL4	15	0				
450	Vertical Coring Level(Enhancer Gain) [VECOR0_P6]	HD2/HD3/HD9/HD10	15	0				
451	Vertical Coring Level(Enhancer Gain) [VECOR0_P7]	HD1/HD4/HD5/HD6/HD7/HD8	15	0				
452	Vertical Coring Level(Enhancer Gain) [VECORPC_P1]	PC	15	0				
453	Vertical Coring Level(Enhancer Gain) EU[VECORE_P1]	PAL1-RF/multi	15	0				
454	YFRNR Input Gain (Main) 2pictures [MYNRG0]	except HD-HD	7	1				
455	HD-NTSC,HD-PAL(sub)[MYNRG1]	HD-HD	7	4				
456	4pictures[MYNRG2]	NT-*/PAL-*	7	1				
457	[MYNRG3]	HD-*	7	4				
458	YFRNR Input Gain(Sub) [YCNRG0]	2pictures	7	4				
459	[YCNRG1]	4pictures/12pictures	7	1				
460	CFRNR Input Gain 8Main 2pictures [MCNRG0]	except HD-HD	7	3				
461	<HD-NTSC,HD-PAL(Sub) [MCNRG1]	HD-HD	7	4				
462	[MCNRG2]		7	4				
463	[MCNRG3]	HD-*	7	4				
464	CFRNR Input Gain [SCNRG0]	2pictures	7	3				
465	[SCNRG1]	4pictures/12pictures	7	4				
466	YFRNR Transition Level [MYNRP0]	NT1/PAL1/multi	7	1				
467	[MYNRP5]	NT1/PAL1-Video	7	0				
468	[MYNRP6]	NT2/NT3/NT4/PAL2/PAL3/PAL4	7	0				
469	[MYNRP7]	HD2/HD3/HD9/HD10	7	0				
470	[MYNRP8]	HD1/HD4/HD5/HD6/HD7/HD8	7	0				
471	YFRNR Transition Level (Main/Sub) [MCNRP0]	NT1/PAL1/multi	7	2				
472	[MCNRP5]	NT1/PAL1-video	7	2				
473	[MCNRP6]	NT2/NT3/NT4/PAL2/PAL3/PAL4	7	2				
474	[MCNRP7]	HD2/HD3/HD9/HD10	7	2				
475	[MCNRP8]	HD1/HD4/HD5/HD6/HD7/HD8	7	0				
476	Vertical Enhancer [YVEG0_PO]	NTSC/PAL(-except RF)	15	8				
477	[YVEG1_PO]	HD2/HD3/HD9/HD10	15	12				
478	[YVEG2_PO]	HD1/HD4/HD5/HD6/HD7/HD8	15	8				
479	AS[YVEG3_PO]	PAL1-RF/multi	15	8				
480	EU[YVEG0_E_PO]	PAL1-RF/multi	15	8				
481	Vertical RGB Gain For Y/G [YVDSBG0_PO]	NTSC/PAL/multi	3	0				

CMP420V1/CMP420V2/42EDT41 (PW1A)

○ : Should be adjusted
△ : Should be followed previous data

Adj. No.	Function		Maximum Value	Default	Changed Component			
	Adjust Items	Mode			Formatter PWB	VIDEO PWB	TUNER PWB	PDP PANEL
482	[YVDSBG1_P0]	HD2/HD3/HD9/HD10	3	0				
483	[YVDSBG2_P0]	HD1/HD4/HD5/HD6/HD7/HD8	3	0				
484	Vertical RGB Coring For Y/G [YVDSBG0_P0]	NTSC/PAL/multi	7	0				
485	[YVDSBG1_P0]	HD	7	3				
486	Vertical Enhancer Clip for Y/G [YVECLP0_P0]	NTSC/PAL/multi	1	1				
487	[YVECLP1_P0]	HD	1	1				
488	Vertical Clip Offset level [YVECLP0_P0]	NTSC/PAL/multi	15	7				
489	[YVECLP1_P0]	HD	15	1				
490	Vertical Non Linear Peaking for Y/G [YVNLPO_P0]	NTSC/PAL/multi	63	0				
491	[YVNLPO_P0]	HD	63	0				
492	Horizontal HPF Peak Freq SW for Y/G [YHHPF0_P0]	NTSC/PAL/multi	3	2				
493	[YHHPF1_P0]	HD2/HD3/HD9/HD10	3	1				
494	[YHHPF2_P0]	HD1/HD4/HD5/HD6/HD7/HD8	3	1				
495	Horizontal Enhancer Gain for Y/G [YHEG0_P0]	NTSC/PAL(except -RF)	15	15				
496	[YHEG1_P0]	HD2/HD3/HD9/HD10	15	15				
497	[YHEG2_P0]	HD1/HD4/HD5/HD6/HD7/HD8	15	0				
498	AS[YHEG3_P0]	PAL1-RF/multi	15	15				
499	EU[YHEG0_E_P0]	PAL1-RF/multi	15	15				
500	Horizontal DSB Gain for Y/G [YHDSBG0_P0]	NTSC/PAL/multi	3	3				
501	[YHDSBG1_P0]	HD2/HD3/HD9/HD10	3	0				
502	[YHDSBG2_P0]	HD1/HD4/HD5/HD6/HD7/HD8	3	0				
503	Horizontal DSB Coring for Y/G [YHDSBC0_P0]	NTSC/PAL/multi	7	1				
504	[YHDSBC1_P0]	HD	7	0				
505	Horizontal Enhancer Clip for Y/G [YHECLP0_P0]	NTSC/PAL/multi	1	0				
506	[YHECLP1_P0]	HD	1	0				
507	Horizontal Clip Offset Level for Y/G AS[YHECLPL0_P0]	RF/multi	15	2				
508	AS[YHECLPL1_P0]	NT1-except RF/PAL1-except RF	15	2				
509	[YHECLPL2_P0]	HD	15	1				
510	EU[YHECLPL0_E_P0]	RF/multi	15	4				
511	EU[YHECLPL1_E_P0]	NT1-except RF/PAL1-except RF	15	4				
512	Horizontal Non Linear Peaking for Y/G [YHNLPO_P0]	NTSC/PAL/multi	63	0				
513	[YHNLPO_P0]	HD	63	0				
514	Coring Amplitude for Y/G [YCOR0_P0]	NT1-RF/PAL1-RF/multi	7	7				
515	[YCOR1_P0]	NT1-Video/PAL1-Video	7	5				
516	[YCOR2_P0]	NT2/NT3/NT4/PAL2/PAL3/PAL4	7	3				
517	[YCOR3_P0]	HD2/HD3/HD9/HD10	7	1				
518	[YCOR4_P0]	HD1/HD4/HD5/HD6/HD7/HD8	7	1				
519	Vertical Enhancer Gain for Y/G [YVEG0_P1]	NTSC/PAL(-RF以外)	15	8				
520	[YVEG1_P1]	HD2/HD3/HD9/HD10	15	12				
521	[YVEG2_P1]	HD1/HD4/HD5/HD6/HD7/HD8	15	8				
522	AS[YVEG3_P1]	PAL1-RF/multi	15	8				
523	EU[YVEG0_E_P1]	PAL1-RF/multi	15	8				
524	Vertical DSB Gain for Y/G [YVDSBG0_P1]	NTSC/PAL/multi	3	0				
525	[YVDSBG1_P1]	HD2/HD3/HD9/HD10	3	0				
526	[YVDSBG2_P1]	HD1/HD4/HD5/HD6/HD7/HD8	3	0				
527	Vertical DSB Coring for Y/G [YVDSBC0_P1]	NTSC/PAL/multi	7	0				
528	[YVDSBC1_P1]	HD	7	3				
529	Vertical Enhancer Clip for Y/G [YVECLP0_P1]	NTSC/PAL/multi	1	1				
530	[YVECLP1_P1]	HD	1	1				
531	Vertical Clip Offset Level for Y/G [YVECLP0_P1]	NTSC/PAL/multi	15	7				
532	[YVECLP1_P1]	HD	15	1				
533	Vertical Non Linear Peaking for Y/G [YVNLPO_P1]	NTSC/PAL/multi	63	0				
534	[YVNLPO_P1]	HD	63	0				
535	Horizontal HPF Peak Freq SW for Y/G [YHHPF0_P1]	NTSC/PAL/multi	3	2				
536	[YHHPF1_P1]	HD2/HD3/HD9/HD10	3	1				
537	[YHHPF2_P1]	HD1/HD4/HD5/HD6/HD7/HD8	3	1				
538	Horizontal Enhancer Gain for Y/G [YHEG0_P1]	NTSC/PAL(except-RF)	15	10				
539	[YHEG1_P1]	HD2/HD3/HD9/HD10	15	10				
540	[YHEG2_P1]	HD1/HD4/HD5/HD6/HD7/HD8	15	0				
541	AS[YHEG3_P1]	PAL1-RF/multi	15	10				
542	EU[YHEG0_E_P1]	PAL1-RF/multi	15	10				
543	Horizontal DSB Gain for Y/G [YHDSBG0_P1]	NTSC/PAL/multi	3	2				
544	[YHDSBG1_P1]	HD2/HD3/HD9/HD10	3	0				
545	[YHDSBG2_P1]	HD1/HD4/HD5/HD6/HD7/HD8	3	0				
546	Horizontal DSB Coring for Y/G [YHDSBC0_P1]	NTSC/PAL/multi	7	1				
547	[YHDSBC1_P1]	HD	7	0				
548	Horizontal Enhancer Clip for Y/G [YHDSBC0_P1]	NTSC/PAL/multi	1	0				
549	[YHDSBC1_P1]	HD	1	0				
550	Horizontal Clip Offset Level for Y/G AS[YHCLPL0_P1]	RF/multi	15	1				

CMP420V1/CMP420V2/42EDT41 (PW1A)

○ : Should be adjusted
△ : Should be followed previous data

Adj. No.	Function		Maximum Value	Default	Changed Component			
	Adjust Items	Mode			Formatter PWB	VIDEO PWB	TUNER PWB	PDP PANEL
551	AS[YHCLPL1_P1]	except NT1-RF/PAL1-except RF	15	1				
552	[YHECLPL2_P1]	HD	15	0				
553	EU[YHECLPL0_E_P1]	RF/multi	15	4				
554	EU[YHECLPL1_E_P1]	NT1-RF以外/PAL1-except RF	15	4				
555	Horizontal Non Linear Peaking for Y/G [YHNLPO_P1]	NTSC/PAL/multi	63	0				
556	[YHNLPL1_P1]	HD	63	0				
557	Coring Amplitude for Y/G [YC0R0_P1]	NT1-RF/PAL1-RF/multi	7	7				
558	[YC0R1_P1]	NT1-video/PAL1-video	7	5				
559	[YC0R2_P1]	NT2/NT3/NT4/PAL2/PAL3/PAL4	7	3				
560	[YC0R3_P1]	HD2/HD3/HD9/HD10	7	1				
561	[YC0R4_P1]	HD1/HD4/HD5/HD6/HD7/HD8	7	1				
562	Vertical enhancer Gain for B-Y/B, R-Y/R [CVEG0]	NTSC/PAL/multi	15	15				
563	[CVEG1]	HD	15	9				
564	DSB Gain of Vertical for B-Y/B, R-Y/R [CVDSBG0]	NTSC/PAL/multi	3	0				
565	[CVDSBG1]	HD	3	0				
566	DSB coring of Vertical for B-Y/B, R-Y/R [CVDSBC0]	NTSC/PAL/multi	7	0				
567	[CVDSBC1]	HD	7	0				
568	Vertical enhancer Clip for B-Y/B, R-Y/R [CVECLP0]	NTSC/PAL/multi	1	0				
569	[CVECLP1]	HD	1	0				
570	Horizontal HPF Peak Freq. SW for B-Y/B, R-Y/R [CHHPF0]	NTSC/PAL/multi	3	2				
571	[CHHPF1]	HD	3	2				
572	Horizontal Enhancer Gain for B-Y/B, R-Y/R [CHEG0]	NTSC/PAL/multi	15	15				
573	[CHEG1]	HD	15	9				
574	Horizontal DSB Gain for B-Y/B, R-Y/R [CHDSBG0]	NTSC/PAL/Multi Picture	3	0				
575	[CHDSBG1]	HD	3	0				
576	Horizontal DSB Coring for B-Y/B, R-Y/R [CHDSBC0]	NTSC/PAL/Multi Picture	7	0				
577	[CHDSBC1]	HD	7	0				
578	Horizontal Enhancer Clip fo B-Y/B, R-Y/R [CHECLP0]	NTSC/PAL/Multi Picture	1	0				
579	[CHECLP1]	HD	1	0				
580	Coring Amplitude for B-Y/B, R-Y/R [CC0R0]	NTSC/PAL/Multi Picture	7	1				
581	[CC0R1]	HD	7	1				
582	B-Y Clamp offset [Except D Sub Component]	NT1/2/3,HD2/3,PAL1/2/3,HD9/10	255	128				
583	R-Y Clamp offset [Except D Sub Component]	NT1/2/3,HD2/3,PAL1/2/3,HD9/10	255	128				
584	B-Y Clamp offset [Except D Sub Component]	HD1/4,HD7/8	255	128				
585	R-Y Clamp offset [Except D Sub Component]	HD1/4,HD7/8	255	128				
586	B-Y Clamp offset [Except D Sub Component]	HD5/6	255	128				
587	R-Y Clamp offset [Except D Sub Component]	HD5/6	255	128				
588	B-Y Clamp offset [D Sub Component]	NT1/2/3,HD2/3,PAL1/2/3,HD9/10	255	128				
589	R-Y Clamp offset [D Sub Component]	NT1/2/3,HD2/3,PAL1/2/3,HD9/10	255	128				
590	B-Y Clamp offset [D Sub Component]	HD1/4,HD7/8	255	128				
591	R-Y Clamp offset [D Sub Component]	HD1/4,HD7/8	255	128				
592	B-Y Clamp offset [D Sub Component]	HD5/6	255	128				
593	R-Y Clamp offset [D Sub Component]	HD5/6	255	128				
594	B-Y Clamp offset [DVI-STB]	480i/576i/480p/576p/VGA	255	128				
595	R-Y Clamp offset [DVI-STB]	480i/576i/480p/576p/VGA	255	128				
596	B-Y Clamp offset [DVI-STB]	1080i-50/1080i-60	255	128				
597	R-Y Clamp offset [DVI-STB]	1080i-50/1080i-60	255	128				
598	B-Y Clamp offset [DVI-STB]	720p-60	255	128				
599	R-Y Clamp offset [DVI-STB]	720p-60	255	128				
600	Y OUT LEVEL M (4.5) For Asia	Main	63	15				
601	Y OUT LEVEL B/G (5.5) For Asia	Main	63	13				
602	Y OUT LEVEL D/K (6.5) For Asia	Main	63	16				
603	Y OUT LEVEL I (6.0) For Asia	Main	63	14				
604	Y OUT LEVEL B/G (5.5) For Europe	Main	63	13				
605	Y OUT LEVEL D/K (6.5) For Europe	Main	63	16				
606	Y OUT LEVEL I (6.0) For Europe	Main	63	19				
607	Y OUT LEVEL L (6.5) For Europe	Main	63	13				
608	Y OUT LEVEL L' (6.1) For Europe	Main	63	12				
609	Y OUT LEVEL M (4.5) For US	Main	63	13				
610	C OUT LEVEL M (4.5) For Asia	Main	63	7				
611	C OUT LEVEL B/G (5.5) For Asia	Main	63	13				
612	C OUT LEVEL D/K (6.5) For Asia	Main	63	13				
613	C OUT LEVEL I (6.0) For Asia	Main	63	13				
614	C OUT LEVEL B/G (5.5) For Europe	Main	63	8				
615	C OUT LEVEL D/K (6.5) For Europe	Main	63	8				
616	C OUT LEVEL I (6.0) For Europe	Main	63	3				
617	C OUT LEVEL L (6.5) For Europe	Main	63	8				
618	C OUT LEVEL L' (6.1) For Europe	Main	63	8				
619	C OUT LEVEL M (4.5) For US	Main	63	13				

CMP420V1/CMP420V2/42EDT41 (PW1A)

O : Should be adjusted
 Δ : Should be followed previous data

Adj. No.	Function		Maximum Value	Default	Changed Component			
	Adjust Items	Mode			Formatter PWB	VIDEO PWB	TUNER PWB	PDP PANEL
620	Y OUT LEVEL M (4.5) For Asia	Sub	63	14				
621	Y OUT LEVEL B/G (5.5) For Asia	Sub	63	13				
622	Y OUT LEVEL D/K (6.5) For Asia	Sub	63	15				
623	Y OUT LEVEL I (6.0) For Asia	Sub	63	13				
624	Y OUT LEVEL B/G (5.5) For Europe	Sub	63	13				
625	Y OUT LEVEL D/K (6.5) For Europe	Sub	63	16				
626	Y OUT LEVEL I (6.0) For Europe	Sub	63	20				
627	Y OUT LEVEL L (6.5) For Europe	Sub	63	13				
628	Y OUT LEVEL L' (6.1) For Europe	Sub	63	13				
629	Y OUT LEVEL M (4.5) For US	Sub	63	13				
630	C OUT LEVEL M (4.5) For Asia	Sub	63	7				
631	C OUT LEVEL B/G (5.5) For Asia	Sub	63	13				
632	C OUT LEVEL D/K (6.5) For Asia	Sub	63	13				
633	C OUT LEVEL I (6.0) For Asia	Sub	63	13				
634	C OUT LEVEL B/G (5.5) For Europe	Sub	63	13				
635	C OUT LEVEL D/K (6.5) For Europe	Sub	63	13				
636	C OUT LEVEL I (6.0) For Europe	Sub	63	13				
637	C OUT LEVEL L (6.5) For Europe	Sub	63	13				
638	C OUT LEVEL L' (6.1) For Europe	Sub	63	13				
639	C OUT LEVEL M (4.5) For US	Sub	63	13				
640	Contrast Center (CM) ((Contrast Offset (CM) for only WVGA& LCD model))	DVI-PC	254	128				
641	Contrast Center (CM) ((Contrast Offset (CM) for only WVGA& LCD model))	DVI-STB (With Setup)	254	149				
642	Contrast Center (CM) ((Contrast Offset (CM) for only WVGA& LCD model))	DVI-STB (Without Setup)	254	128				
643	Contrast Center (CM) ((Contrast Offset (CM) for only WVGA& LCD model))	DSUB-RGB	254	128				
644	Contrast Center (CM) ((Contrast Offset (CM) for only WVGA& LCD model))	Expand DSUB-RGB (Reserved)	254	128				
645	Contrast Center (CM) ((Contrast Offset (CM) for only WVGA& LCD model))	DSUB-COMP	254	137				
646	Brightness Center (CM)	DVI-PC	254	128				
647	Brightness Center (CM)	DVI-STB	254	128				
648	Brightness Center (CM)	DSUB-RGB	254	128				
649	Brightness Center (CM)	Expand DSUB-RGB (Reserved)	254	128				
650	Brightness Center Offset	DSUB-COMP	254	127				
651	Color Center (CM)	DVI-PC	127	64				
652	Color Center (CM)	DVI-STB (480i/576i/480p/576p)	127	82				
653	Color Center (CM)	DVI-STB (720p-60/1080i-60/1080i-50)	127	82				
654	Color Center (CM)	DVI-STB (VGA)	127	82				
655	Color Center (CM)	DSUB-RGB	127	64				
656	Tint Center (CM)	DVI-PC	254	128				
657	Tint Center (CM)	DVI-STB (480i/576i/480p/576p)	254	128				
658	Tint Center (CM)	DVI-STB (720p-60/1080i-60/1080i-50)	254	128				
659	Tint Center (CM)	DVI-STB (VGA)	254	128				
660	Tint Center (CM)	DSUB-RGB	254	128				
661	Center of Sharpness (HV Enhance Gain for Y)	DVI-STB (480i/576i)	31	14				
662	Center of Sharpness (HV Enhance Gain for Y)	DVI-STB (480p/576p)	31	10				
663	Center of Sharpness (HV Enhance Gain for Y)	DVI-STB (720p-60)	31	6				
664	Center of Sharpness (HV Enhance Gain for Y)	DVI-STB (1080i-60/1080i-50)	31	10				
665	Center of Sharpness (HV Enhance Gain for Y)	DVI-STB (VGA)	31	10				
666	DVI-STB Setup 0:None VGA/Others Yes, 1:All none 2:All have	DVI-STB mode	2	0				
667	HSYNC De-Jitter 0:Low (Disabled), 1:(High (Enabled)	DVI-PC	1	0				
668	HSYNC De-Jitter 0:Low (Disabled), 1:(High (Enabled)	DVI-STB	1	0				
669	HSYNC De-Jitter 0:Low (Disabled), 1:(High (Enabled)	AVC	1	0				
670	Offset level of Horizontal CLIP for Y/G AS[YHECLPL3_P0]	NT2,3,4/PAL2,3,4	15	10				
671	EU[YHECLPL3_E_P0]	NT2,3,4/PAL2,3,4	15	10				
672	Offset level of Horizontal CLIP for Y/G AS[YHCLPL3_P1]	NT2,3,4/PAL2,3,4	15	10				
673	EU[YHCLPL3_E_P1]	NT2,3,4/PAL2,3,4	15	10				
674	Y_DL (4.5MHz) For US	Main	10	7				
675	Y_DL (4.6MHz) For US	Sub	10	7				
676	Y_DL (5.5MHz PAL/NTSC4.43) For Europe	Main	10	4				
677	Y_DL (5.5MHz SECAM) For Europe	Main	10	1				
678	Y_DL (6.0PAL/NTSC4.43) For Europe	Main	10	8				
679	Y_DL (6.0SECAM) For Europe	Main	10	5				
680	Y_DL (5.5MHz PAL/NTSC4.43) For Europe	Sub	10	2				
681	Y_DL (5.5MHz SECAM) For Europe	Sub	10	0				
682	Y_DL (6.0PAL/NTSC4.43) For Europe	Sub	10	4				
683	Y_DL (6.0SECAM) For Europe	Sub	10	0				
684	Y_DL (6.5MHz PAL/NTSC4.43) For Europe	Main	10	5				
685	Y_DL (6.5MHz SECAM) For Europe	Main	10	5				
686	Y_DL (6.5MHz PAL/NTSC4.43) For Europe	Sub	10	2				
687	Y_DL (6.5MHz SECAM) For Europe	Sub	10	0				
688	Center of Sharpness (HV Enhancer Gain for Y) For Asia/US	TV	31	19				

CMP420V1/CMP420V2/42EDT41 (PW1A)

O : Should be adjusted
 Δ : Should be followed previous data

Adj. No.	Function		Maximum Value	Default	Changed Component			
	Adjust Items	Mode			Formatter PWB	VIDEO PWB	TUNER PWB	PDP PANEL
689	Center of Sharpness (HV Enhancer Gain for Y) For Asia/US	VIDEO	31	24				
690	Center of Sharpness (HV Enhancer Gain for Y) For Asia/US	HD5/HD6	31	11				
691	Center of Sharpness (HV Enhancer Gain for Y) For Asia/US	HD1/HD4/HD7/HD8	31	7				
692	Center of Sharpness (HV Enhancer Gain for Y) For Asia/US	HD2/HD3/HD9/HD10	31	15				
693	Center of Sharpness (HV Enhancer Gain for Y) For Asia/US	NT2/NT3/PAL2/PAL3/NT4/PAL4	31	9				
694	Center of Sharpness (HV Enhancer Gain for Y) For Asia/US	TEXT(2pictures)	31	15				
695	Contrast mode<Dynamic> SW (TV) 0:Dynamic 1:Dynamic+Auto	TV	1	0				
696	V detection(FORMATTER PWB) 0:out of range 128: NO V (or out of spec) 255:interrupt	50/60Hz	255	-				
697	H detection(FORMATTER PWB) 0:out of range 128: NO V (or out of spec) 255:interrupt	15/28/31/33/45kHz	255	-				
698	V detection (VIDEO PWB) 0:out of range 128:NO V 255 interrupt	50/60Hz	255	-				
699	H detection (VIDEO PWB) 0:out of range 128:NO V 255 interrupt	15/28/31/33/45kHz	255	-				
700	Q mode 0:Freeze, 1:Move 1, 2:Move 2 For 55V	50Hz[Natural/Night] mode	2	1				
701	Q mode 0:Freeze, 1:Move 1, 2:Move 2 For 55V	60Hz[Natural/Night] mode	2	1				
702	Dispersion Time of Sustain current 0: 2 Times, 1: 4 times	For PC-Movie mode	1	1				
703	SMPLING	For CCD	255	0				
704	POLLING	For CCD	255	15				
705	START	For CCD	7	2				
706	TIMEOUT	For CCD	30	5				
707	STATUS	For CCD	7	2				
708	CCD-HP	For CCD	79	40				
709	CCD-CLK	For CCD	79	57				
710	Sharpness Gain	For Main 480i/576i	15	10				
711	Sharpness EQ	For Main 480i/576i	3	1				
712	Sharpness f0	For Main 480i/576i	3	1				
713	Cb Offset1	For Main 480i/576i	15	8				
714	Cr Offset1	For Main 480i/576i	15	8				
715	Y out level	For Main 480i/576i	63	15				
716	C out level	For Main 480i/576i	63	15				
717	Sharpness Gain	For Sub 480i/576i	15	10				
718	Sharpness EQ	For Sub 480i/576i	3	1				
719	Sharpness f0	For Sub 480i/576i	3	1				
720	Cb Offset1	For Sub 480i/576i	15	8				
721	Cr Offset1	For Sub 480i/576i	15	8				
722	Y out level	For Sub 480i/576i	63	15				
723	C out level	For Sub 480i/576i	63	15				
724	Offset value of adjusted TINT for impact to No.42-45	For COMPAL factory	20	11				
725	Use item No.724 0:NO , 1:Yes	For COMPAL factory	1	0				
726	Free		31	17				
727	Free		31	20				
728	Free		31	1				
729	Free		31	1				
730	Free		53	12				
731	Free		31	1				
732	Free		-	-				
733	Free		-	-				
734	Free		-	-				
735	Free		-	-				
736	Free		-	-				
737	Free		-	-				
738	Free		-	-				
739	Free		-	-				
740	Gain adjustment of RGB amplifier (FLAON)	Main	-	-	O			O
741	Gain adjustment of RGB amplifier	Sub	-	-	O			O
742	Automatic White Peak Adj.	Single Picture mode	-	-	O			O
743	Automatic White Peak Adj.	Multi Picture mode	-	-	O			O
744	EEPROM Initialize(0:No, 1:Yes)		1	0				
745	Enter to service menu of sub mi-con		-	-				

CMP420V1/CMP420V2/42EDT41 (PW1A)

● Acceptable Signal Formats

PAL1: S and Composite of PAL/SECAM
 PAL2: Component of PAL (YCBCR)
 PAL3: Component of PAL (YPBPR)
 PAL4: Component of PAL (YCBCR-SCART)
 PAL: PAL1-4
 NT1: S and Composite of NTSC
 NT2: Component of NTSC (YCBCR)
 NT3: Component of NTSC (YPBPR)
 NT4: Component of NTSC (YCBCR-SCART)
 NTSC: NTSC1-4
 HD1-6: Component (shown in the table→)
 HD7: Component of 1080i/50 (YPBPR)
 HD8: Component of 1080i/50 (YCBCR)
 HD9: Component of 576p (YPBPR)
 HD10: Component of 576p (YCBCR)
 HD: HD1-10 of Component
 TV: NTSC / HD
 PC: PC signal

Video Input	System	Judgment of H.Frequency	Video Input Setup	Mode
AV1 AV2	PAL	15.75kHz (576i)	Auto	PAL2
			SDTV/DVD	PAL2
			HDTV	PAL3
	NTSC	15.75kHz (480i)	Auto	NT2
			SDTV/DVD	NT2
			HDTV	NT3
	PAL	31.25kHz (576p)	Auto	HD10
			SDTV/DVD	HD10
			HDTV	HD9
	NTSC	31.50kHz (480p)	Auto	HD3
			SDTV/DVD	HD3
			HDTV	HD2
	NTSC	45.00kHz (720p)	Auto	HD5
			SDTV/DVD	HD6
			HDTV	HD5
	PAL	28.125kHz (1080i)	Auto	HD7
			SDTV/DVD	HD8
			HDTV	HD7
NTSC	33.75kHz (1080i)	Auto	HD1	
		SDTV/DVD	HD4	
		HDTV	HD1	

CMP420V1/CMP420V2/42EDT41 (PW1A)

Item	Power Unit Vs, Va Adjustment	Adj. point	Refer the figure below
	Adjustment Preparations	Adjustment Procedures	Remarks
(1)	Turn on the set and perform pre-heat run more than 1 min with burn-in screen.	(1) Turn Vs ADJ to adjust Vs voltage to be within $\pm 0.1V$ of the value specified in the label on the panel.	Permissive level of voltage in sufficient time of heat-run performed is: Vs: within $\pm 0.45V$ Va: within $\pm 0.55V$ Label position (Reference) Upper right If it's hard to read the voltage value because of the wiring, highlight it in advance to be visible.
(2)	Receive full back pattern signal (or Video silence signal; it will be automatically turned off after a few seconds by power save function.)	(2) Turn Va ADJ to adjust Va voltage to be within $\pm 0.2V$ of the value specified in the label on the panel.	
(3)	Connect voltmeter leads to Vs (or Va) and GND test points of the power unit.	(3) Reconfirm that Vs voltage remains within $\pm 0.1V$ of the specified value. Readjust if it's outside of the margin. Label example <div style="border: 1px solid black; padding: 5px; width: fit-content; margin: 10px auto;"> <LOT>N6 Vs= 185.0V Va=65.0V </div>	

Power unit for WVGA

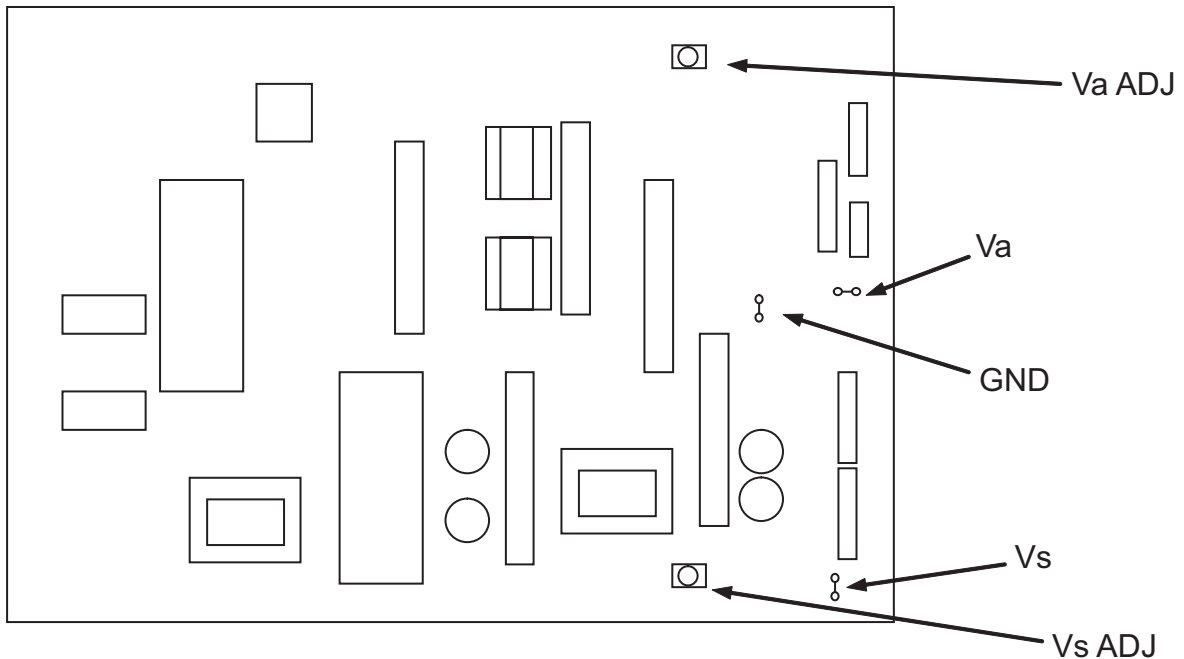

CMP420V1/CMP420V2/42EDT41 (PW1A)

Item	AGC Adjustment (Tuner built-in Model for Asia only)	Adj. point	I ² C
	Adjustment Preparations	Adjustment Procedures	Remarks
(1)	Turn on the set and perform pre-heat run more than 20 min.	(1) Receive AGC adjustment signal. Indicate Service adjustment menu.	No.289(AGC Adjustment) : AGC Adjustment control
(2)	Receive AGC adjustment signal. Internal : (175.25MHz) PAL B/G PHILIPS Field : -50dBm	(2) Display the following signals at the same time. Service adjustment No.289 (AGC adjustment) No.291 (AGC Input)	No.291(AGC Input): AGC Voltage Data
		(3) Raise No.289 data value until No.291 data is saturated (This point: AGC-MAX)	Default Settings No.289:" 50"
		(4) With monitoring No.291 reduce No.289 data value and press [OK] key at the point when No.291 data comes down.	No.291 AGC Voltage: Saturation level

CMP420V1/CMP420V2/42EDT41 (PW1A)

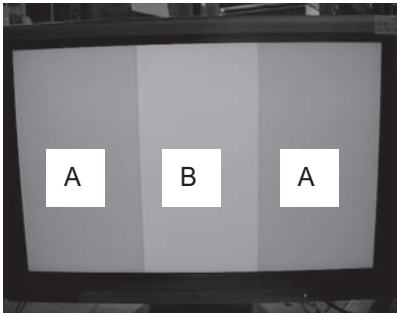
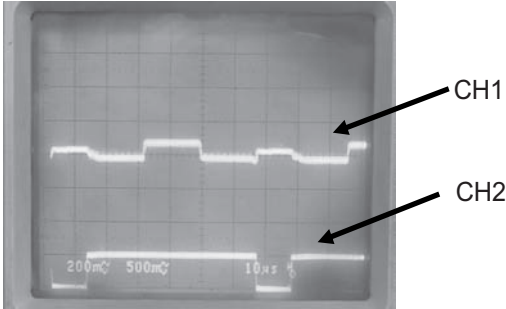
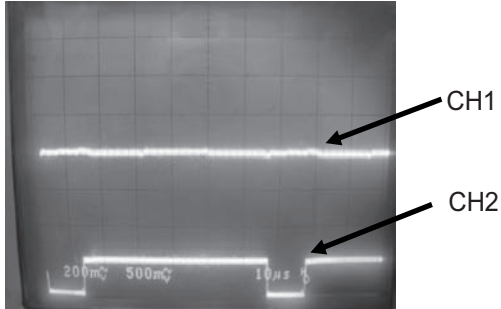
Item	TV-Video Sub-tint Adjustment(Main/Sub)													
Preparation		Procedure												
(1)	Receive Sub-tint adjustment signal of NTSC by AV1 input. (composit) Refer to the following for the details of a signal.	TV Video Sub-tint Adjustment (Main) (1) The waveform of #1pin(Cr output) and #5pin(Y output) of [PYM] Connector is seen. 1pin is connected to CH1. 5pin is connected to CH2. A trigger is applied to CH2.												
<p align="center">Sub-tint adjustment signal</p>  <table border="1" data-bbox="215 1388 726 1512"> <thead> <tr> <th></th> <th>A</th> <th>B</th> </tr> </thead> <tbody> <tr> <td>Luminance</td> <td>40% (0.28V)</td> <td>40% (0.28V)</td> </tr> <tr> <td>Chroma Phase</td> <td>0 degree</td> <td>180 degree</td> </tr> <tr> <td>Chroma level</td> <td>40%</td> <td>40%</td> </tr> </tbody> </table>			A	B	Luminance	40% (0.28V)	40% (0.28V)	Chroma Phase	0 degree	180 degree	Chroma level	40%	40%	(2) It checks that a waveform is like fig.A. (3) The data of No.42 is adjusted so that a waveform of CH1 may be set to fig.B. Press [OK] button after the adjustment. (4) Check that No.42 data is the same as No.43. TV Video Sub-tint Adjustment (Sub) (1) Sub-tint adjustment signal is put into the right-hand side of two screens. 1.Push AV2 of remote control. 2.Push MULTI PICTURE (PinP) Button of remote control, It become two screens. 3.It checks that left-hand side of two screens is AV2. 4.After push yellow button of remote control, and push AV1 of remote control. 5.It checks that right-hand side of two screens is sub -tint adjustment signal. (2) The waveform of #1pin(Cr output) and #5pin(Y output) of [PYS] Connector is seen. 1pin is connected to CH1. 5pin is connected to CH2. A trigger is applied to CH2. (3) It checks that a waveform of is like fig.A. (4) The data of No. 44 is adjusted so that a waveform of CH1 may be set to fig.B (5) Press [OK] button after the adjustment. (6) Check that No. 44 data is the same as No45.
	A	B												
Luminance	40% (0.28V)	40% (0.28V)												
Chroma Phase	0 degree	180 degree												
Chroma level	40%	40%												
<p align="center">Waveform of CH1 and CH2.</p>  <p align="center">Fig.A Before adjustment</p>		 <p align="center">Fig.B After adjustment</p>												

CMP420V1/CMP420V2/42EDT41 (PW1A)

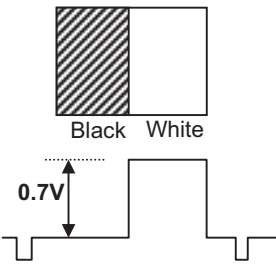
Item	AUTOMATIC SIGNAL LEVEL ADJUSTMENT –RGB (1)	
	Preparation	Procedure
(1)	<p>Input the adjustment signal of VGA (60Hz) format into RGB2 [D-sub] input terminal.</p> <p><u>the adjustment signal</u></p> <div style="border: 1px dashed black; padding: 5px;"> <p>The signal level of black area should be pedestal level. This signal must not be inserted characters etc.</p>  </div>	<p>(1) Select RGB2 and enter the service adjustment mode.</p> <p>(2) Select No.740 “RGB Amp. Gain ADJ.” and press OK button for more than 2 seconds to start the adjustment. It will complete the adjustment after the OSD of “AUTO MODE” disappeared.</p>

[Note] Never adjust without use of the specified signal.

If that were done by mistake, the picture would become abnormal in black level, contrast and color. In this case, it will be recovered by re-adjustment in the specified way.

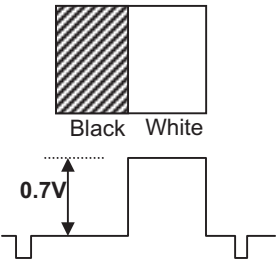
Item	AUTOMATIC SIGNAL LEVEL ADJUSTMENT –RGB (2)	
	Preparation	Procedure
(1)	<p>Input the adjustment signal of 576p or 480p format into AV1 input terminal.</p> <p><u>the adjustment signal</u></p> <div style="border: 1px dashed black; padding: 5px;"> <p>The signal level of black area should be pedestal level. This signal must not be inserted characters etc.</p>  </div>	<p>(1) Select AV1 and enter the service adjustment mode.</p> <p>(2) Select No.740 “RGB Amp. Gain ADJ.” and press OK button for more than 2 seconds to start the adjustment. It will complete the adjustment after the OSD of “AUTO MODE” disappeared.</p> <p>(3) Select No.741 “RGB Amp. Gain ADJ.” and press OK button for more than 2 seconds to start the adjustment. It will complete the adjustment after the OSD of “AUTO MODE” disappeared.</p>

[Note] Never adjust without use of the specified signal.

If that were done by mistake, the picture would become abnormal in black level, contrast and color. In this case, it will be recovered by re-adjustment in the specified way.

CMP420V1/CMP420V2/42EDT41 (PW1A)

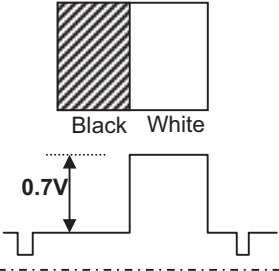
Item	AUTOMATIC SIGNAL LEVEL ADJUSTMENT –VIDEO	
Preparation		Procedure
(1)	<p>Input the adjustment signal of 576p or 480p format into AV1 input terminal. <u>the adjustment signal</u></p> <div style="border: 1px dashed black; padding: 10px; margin: 10px 0;"> <p>The signal level of black area should be pedestal level. This signal must not be inserted characters etc.</p> <div style="text-align: center;">  <p>Black White</p> <p>0.7V</p> </div> </div>	<p>(1) Select AV1 and enter the service adjustment mode.</p> <p>(2) Select No.743 “Automatic White peak Adj. (Multi)” and press OK button for more than 2 seconds to start the adjustment. It will complete the adjustment after the OSD of “AUTO MODE” disappeared.</p>

[Note] Never adjust without use of the specified signal.

If that were done by mistake, the picture would become abnormal in black level, contrast and color.
In this case, it will be recovered by re-adjustment in the specified way.

CMP420V1/CMP420V2/42EDT41 (PW1A)

Item	Video Color Temperature Adjustment (Cool)	Adj. point	I ² C
Adjustment Preparations		Adjustment Procedures	
		Remarks	
(1)	Set the output of signal generator to white raster. (Ratio:100%)	(1)	Perform the following adjustment with the remote control.
(2)	Component signal (480i) Video level:0.714Vp-p SYNC:0.286Vp-p Set-up level:0V	(2)	Set the CRT color analyzer (CA100) at the center of the panel.
(3)	Set Picture MENU to [RESET].	(3)	Ensure that adjustment No. 0, 1, 2 are all set as 224.
(4)	Set into Factory adjustment mode.	(4)	After receiving Video signal, step down the two (or one) among adjustment No. 0, 1, 2 and adjust the value as shown below. At least one of the data should be 224.
			<div style="border: 1px solid black; padding: 5px; margin: 10px 0;"> <p align="center">< Specification > Video color temperature (Cool)</p> <p align="center">x=0.268±0.005</p> <p align="center">y=0.283±0.005</p> <p align="center">(Color temp:12000°K±10MPCD)</p> </div>
			<p>Color temperature should be adjusted under the condition in which the screen is the brightest, thus the initial value of adjustment is it's maximum value.</p> <p>Only reducing the brightness controls the adjustment, thus weaken the brighter color to adjust.</p> <p>Color temperature is at Cool mode while the following No. is selected.</p> <p>Adjustment No. 00, 01, 02.</p>

CMP420V1/CMP420V2/42EDT41 (PW1A)

Item	Video Color Temperature Adjustment (Normal)	Adj. point	I ² C
Adjustment Preparations		Adjustment Procedures	
		Remarks	
(1)	Set the output of signal generator to white raster. (Ratio : 100%)	(1)	Perform the following adjustment with the remote control.
(2)	Component signal (480i) Video level : 0.714Vp-p SYNC : 0.286Vp-p Set-up level : 0V	(2)	Set the CRT color analyzer (CA100) at the center of the panel.
(3)	Set Picture MENU to [RESET]	(3)	Ensure that adjustment No. 3, 4, 5 are all set as 224.
(4)	Set into Factory adjustment mode.	(4)	After receiving Video signal, step down the two (or one) among adjustment No. 3, 4, 5 and adjust the value as shown below. At least one of the data should be 224.
		<div style="border: 1px solid black; padding: 5px;"> <p align="center">< Specification > Video color temperature (Normal)</p> <p align="center">x=0.285±0.005</p> <p align="center">y=0.293±0.005</p> <p align="center">(Color Temp:9300°K±0MPCD)</p> </div>	
		<p>Color temperature should be adjusted under the condition in which the screen is the brightest, thus the initial value of adjustment is it's maximum value.</p> <p>Only reducing the brightness controls the adjustment, thus weaken the brighter color to adjust.</p> <p>Color temperature is at Normal mode while the following No. is selected.</p> <p>Adjustment No. 03, 04, 05</p>	

CMP420V1/CMP420V2/42EDT41 (PW1A)

Item	Video Color Temperature Adjustment (Warm)	Adj. point	I ² C
Adjustment Preparations		Adjustment Procedures	
		Remarks	
(1)	Set the output of signal generator to white raster. (Ratio : 100%)	(1)	Perform the following adjustment with the remote control.
(2)	Component signal (480i) Video level : 0.714Vp-p SYNC : 0.286Vp-p Set-up level : 0V	(2)	Set the CRT color analyzer (CA100) at the center of the panel.
(3)	Set Picture MENU to [RESET]	(3)	Set Color Temperature of PICTURE MENU to[WARM].
(4)	Set into Factory adjustment mode.	(4)	Ensure that adjustment No. 6, 7, 8 are all set as 224.
		(5)	After receiving Video signal, step down the two (or one) among adjustment No. 6, 7, 8 and adjust the value as shown below. At least one of the data should be 224.
			<div style="border: 1px solid black; padding: 5px; margin: 10px 0;"> <p align="center">< Specification > Video color temperature (WARM)</p> <p align="center">x=0.314±0.005</p> <p align="center">y=0.327±0.005</p> <p align="center">(Color Temp:6500°K±0MPCD)</p> </div>
			Color temperature should be adjusted under the condition in which the screen is the brightest, thus the initial value of adjustment is it's maximum value.
			Only reducing the brightness controls the adjustment, thus weaken the brighter color to adjust.
			Color temperature is at Warm mode while the following No. is selected. Adjustment No. 06, 07, 08

CMP420V1/CMP420V2/42EDT41 (PW1A)

Item	PC Color Temperature Adjustment		Adj. point	I ² C
Adjustment Preparations		Adjustment Procedures		Remarks
(1)	This adjustment should be done after video color temperature adjustment.	(1)	Perform the following adjustment with the remote control.	Environment : 20 lux or less Color temperature should be adjusted under the condition in which the screen is the brightest, thus the initial value of adjustment is it' s maximum value. Only reducing the brightness controls the adjustment, thus weaken the brighter color to adjust. Color temperature is at Cool mode while the following No. is selected. Adjustment No. 12, 13, 14
(2)	Set into Factory Adjustment mode.	(2)	Set the CRT color analyzer (CA100) at the center of the panel.	
(3)	Input : RGB2 [D-sub] Signal : VGA (75) 0.7V (No set up) Window ratio : 100%	(3)	Ensure that the adjustments No. 12, 13, 14 are all set as 224.	
(4)	Confirm that the screen size is 'Full' .	(4)	After receiving PC signal, step down the two (or one) among adjustments No. 12, 13, 14 and adjust the value as shown below. At least one of the data should be 224. <div style="border: 1px solid black; padding: 5px; margin: 5px 0;"> <p align="center">< Specification > PC color temperature (Cool)</p> <p align="center">x=0.268±0.005</p> <p align="center">y=0.283±0.005</p> <p align="center">(Color temp:12000°K±10MPCD)</p> </div>	

(5) Write adjustment value of video color temperature to the following NO.

Video Color Temperature		PC Color Temperature
No.3 Data	⇒	No.15 Data
No.4 Data	⇒	No.16 Data
No.5 Data	⇒	No.17 Data
No.6 Data	⇒	No.18 Data
No.7 Data	⇒	No.19 Data
No.8 Data	⇒	No.20 Data
No.9 Data	⇒	No.21 Data
No.10 Data	⇒	No.22 Data
No.11 Data	⇒	No.23 Data

● Flow Chart

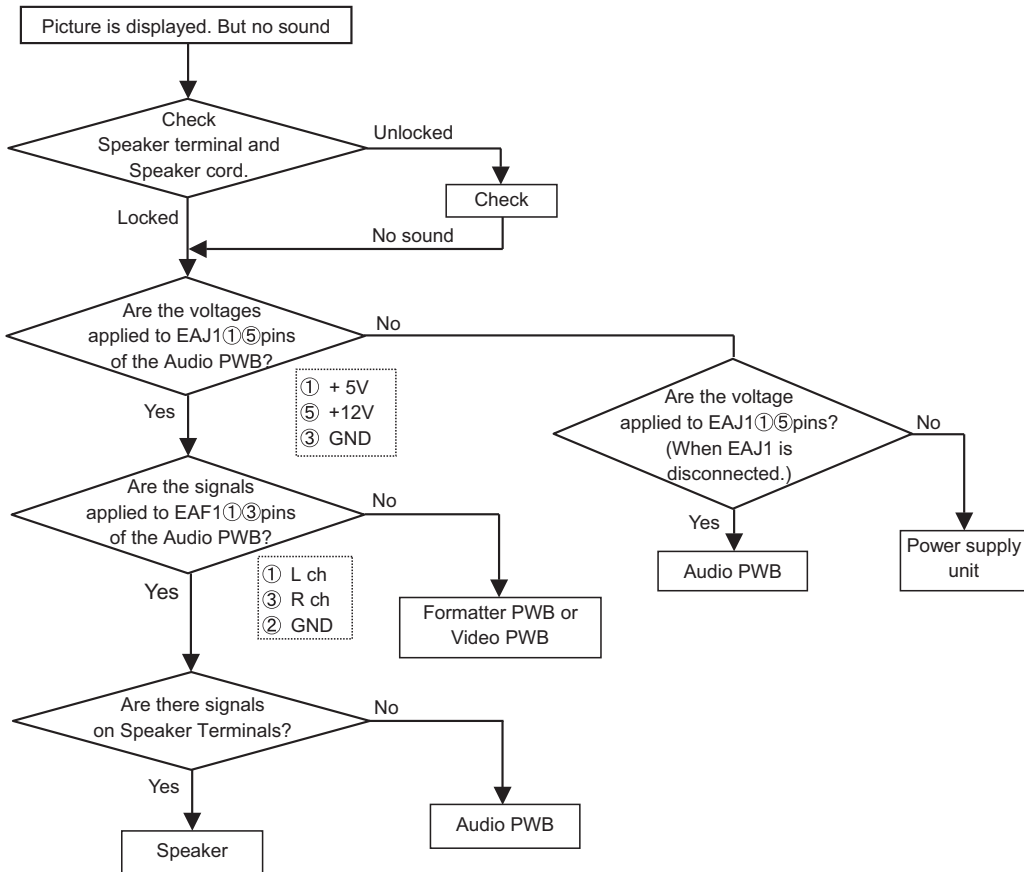
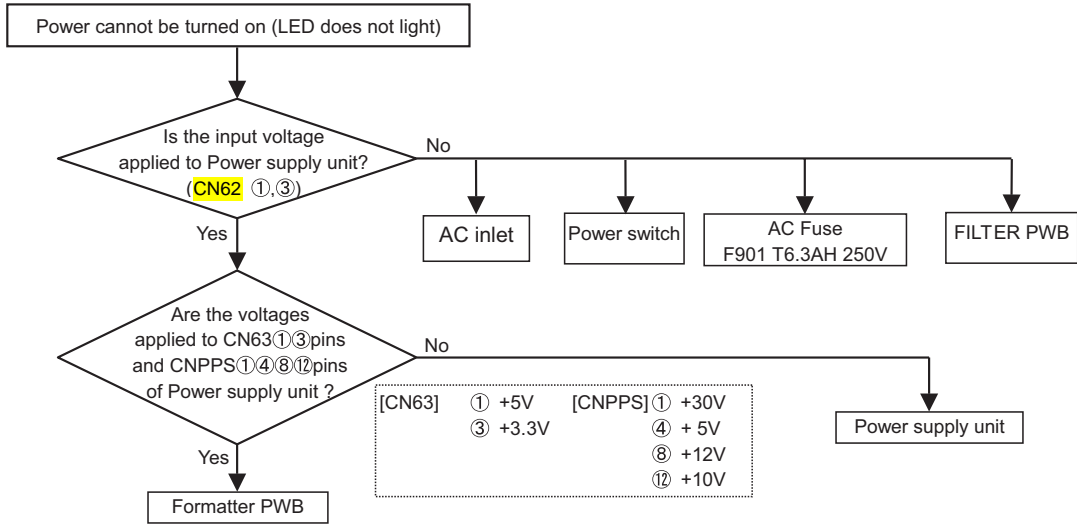

CMP420V1/CMP420V2/42EDT41 (PW1A)

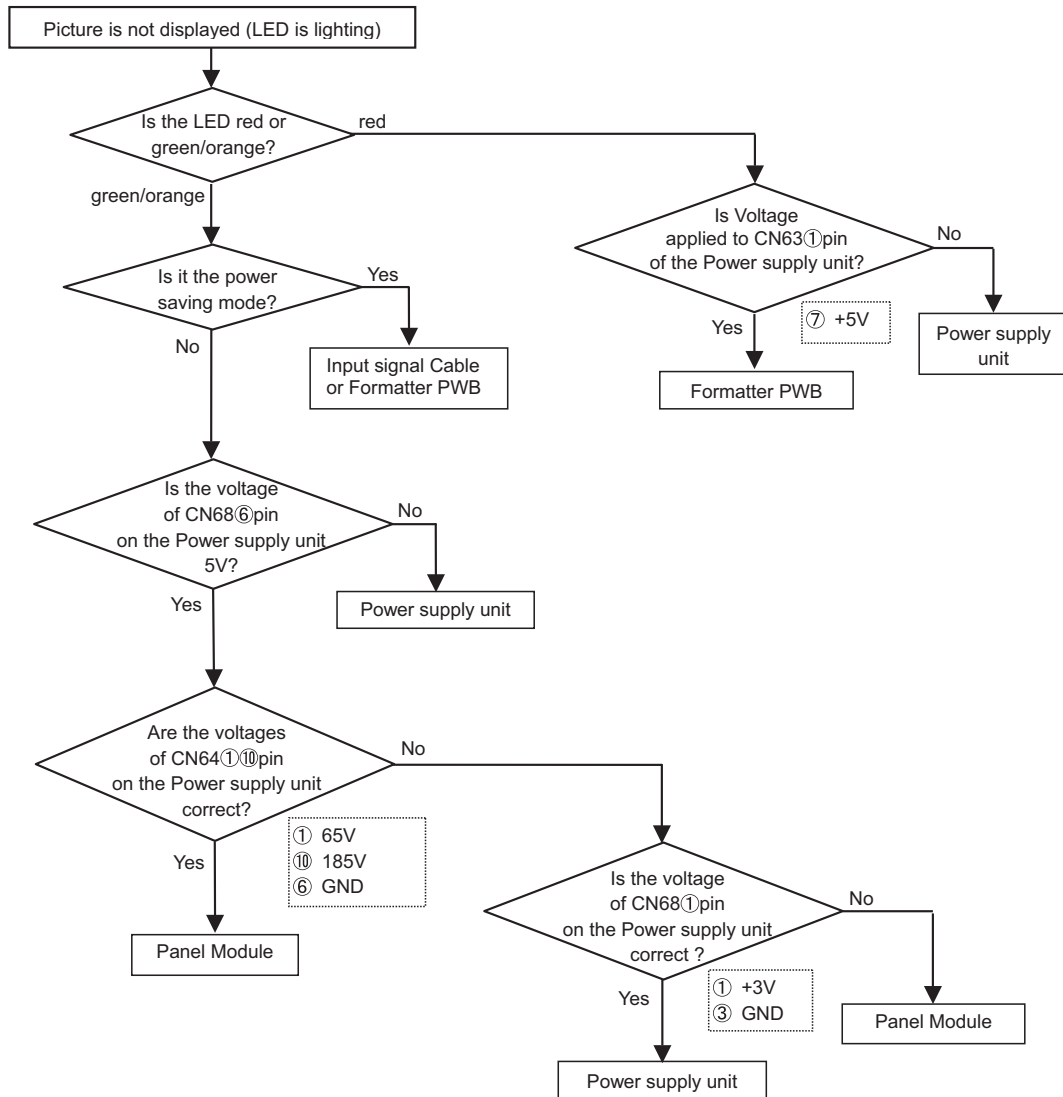

CMP420V1/CMP420V2/42EDT41 (PW1A)

[POWER BOARD]

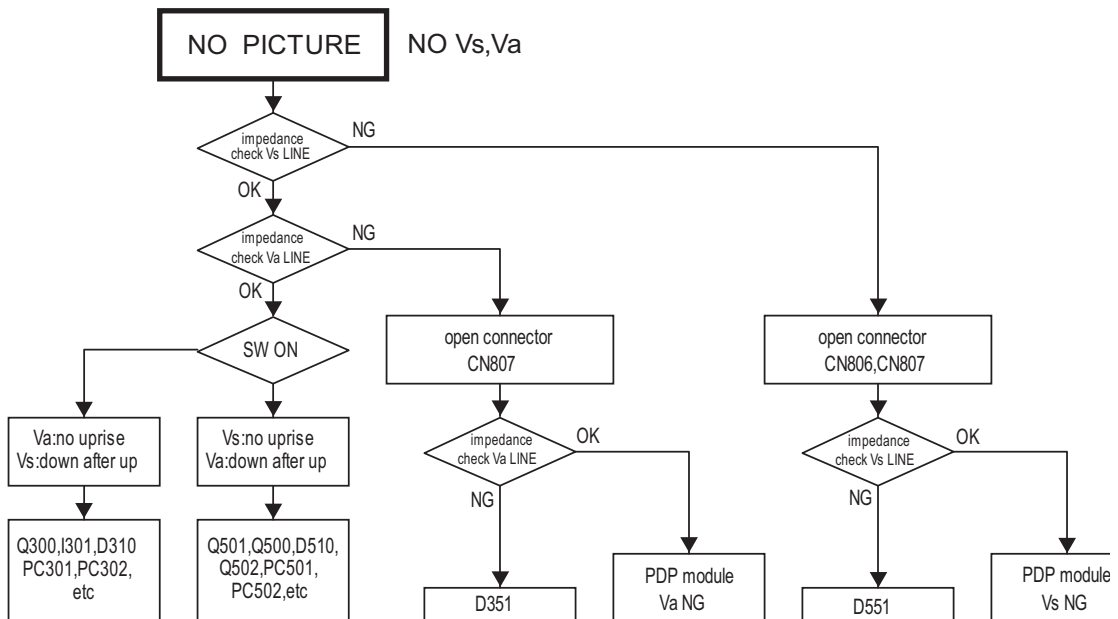
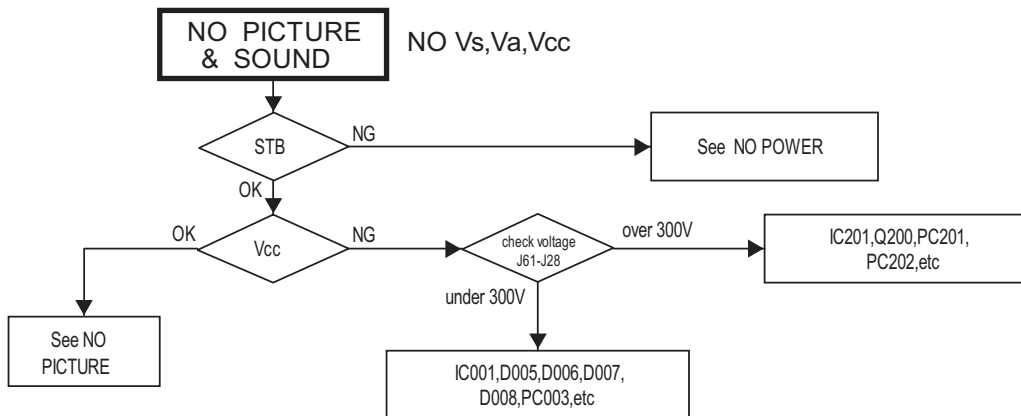
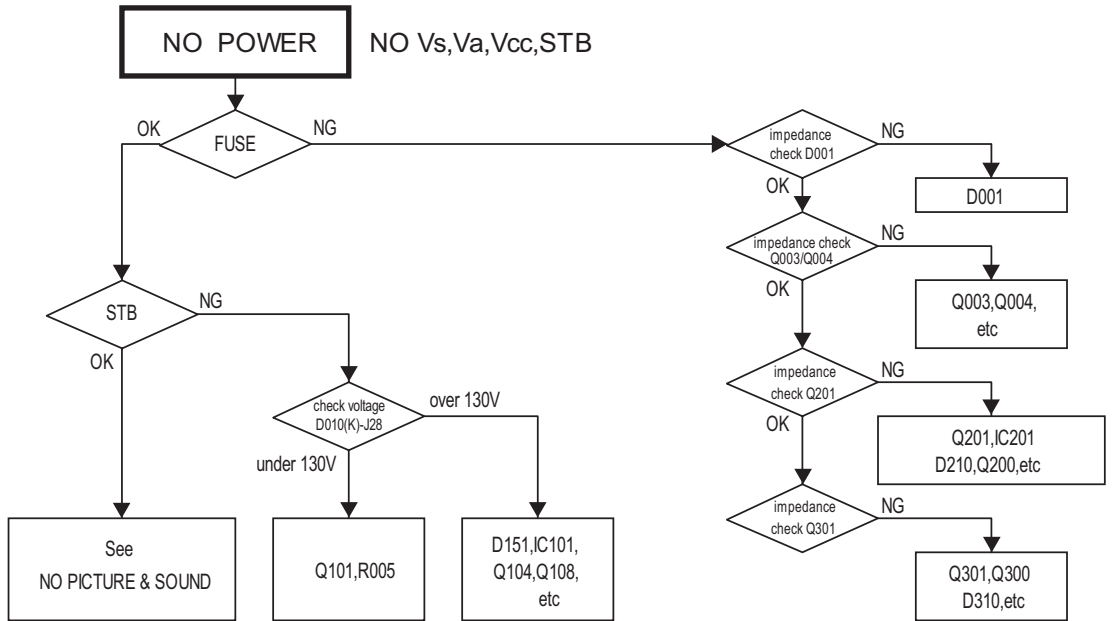

7. Block diagram

[Block diagram 1]

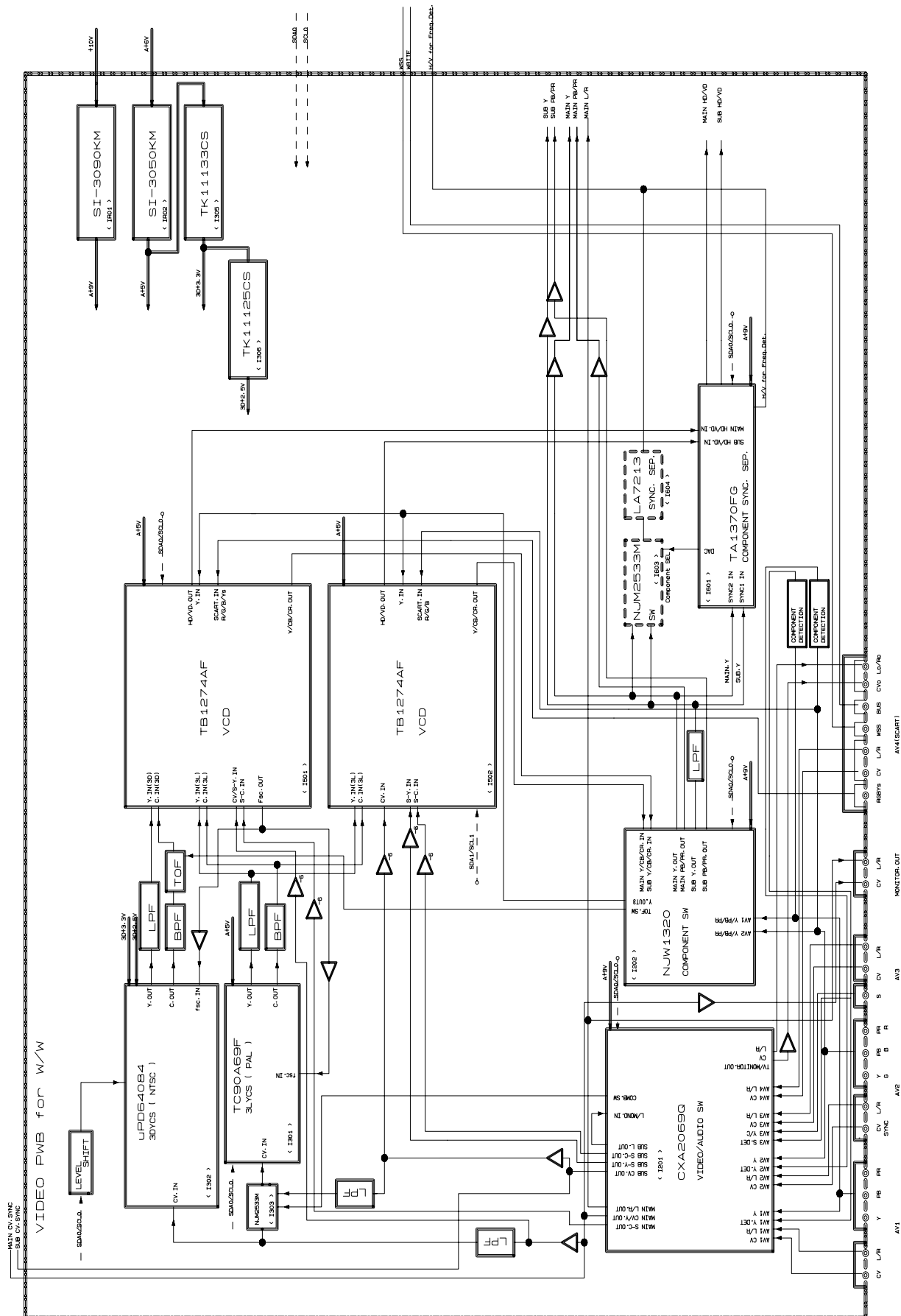

[Block diagram 2]

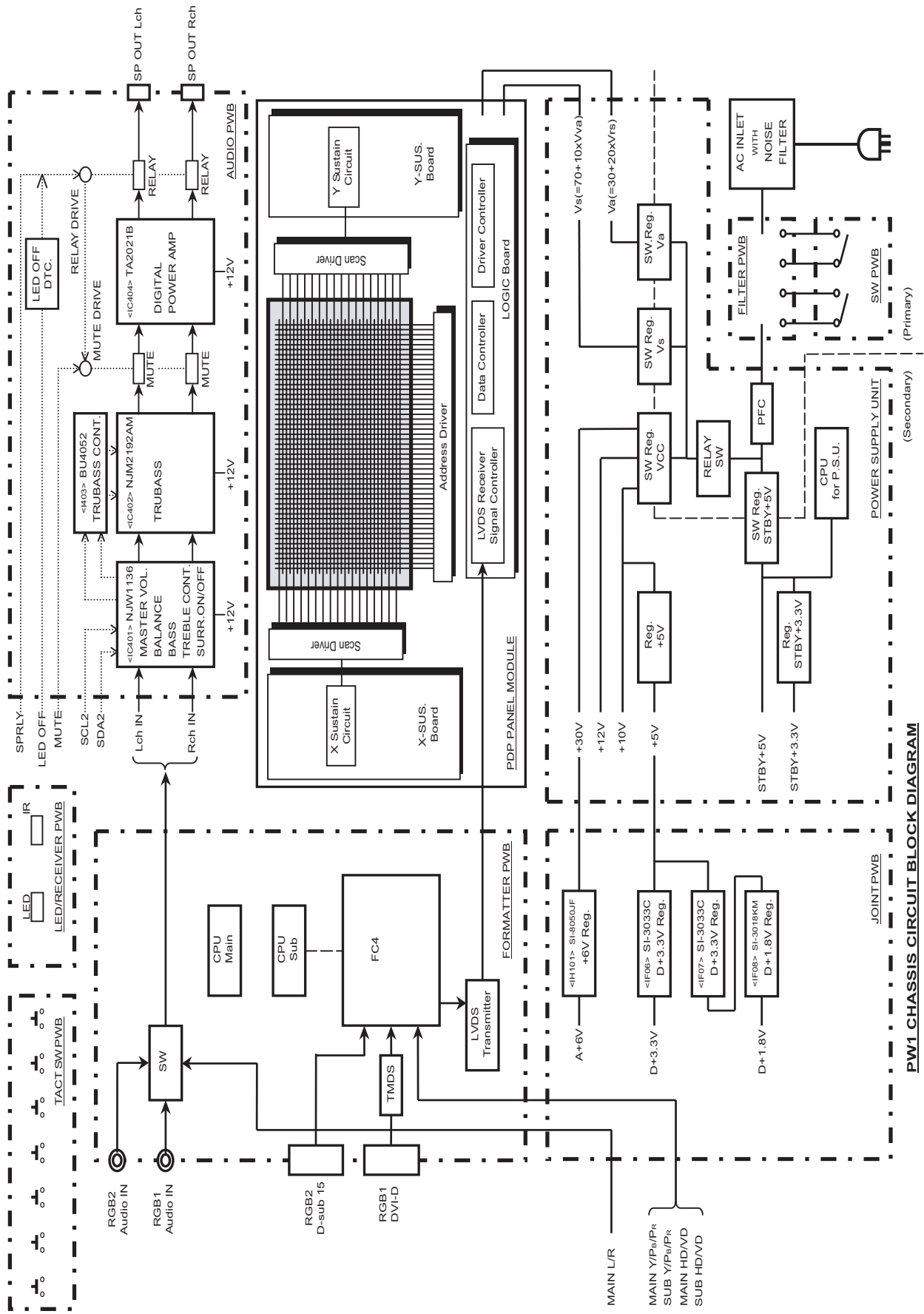

PW1 CHASSIS CIRCUIT BLOCK DIAGRAM

8. Connector connection diagram

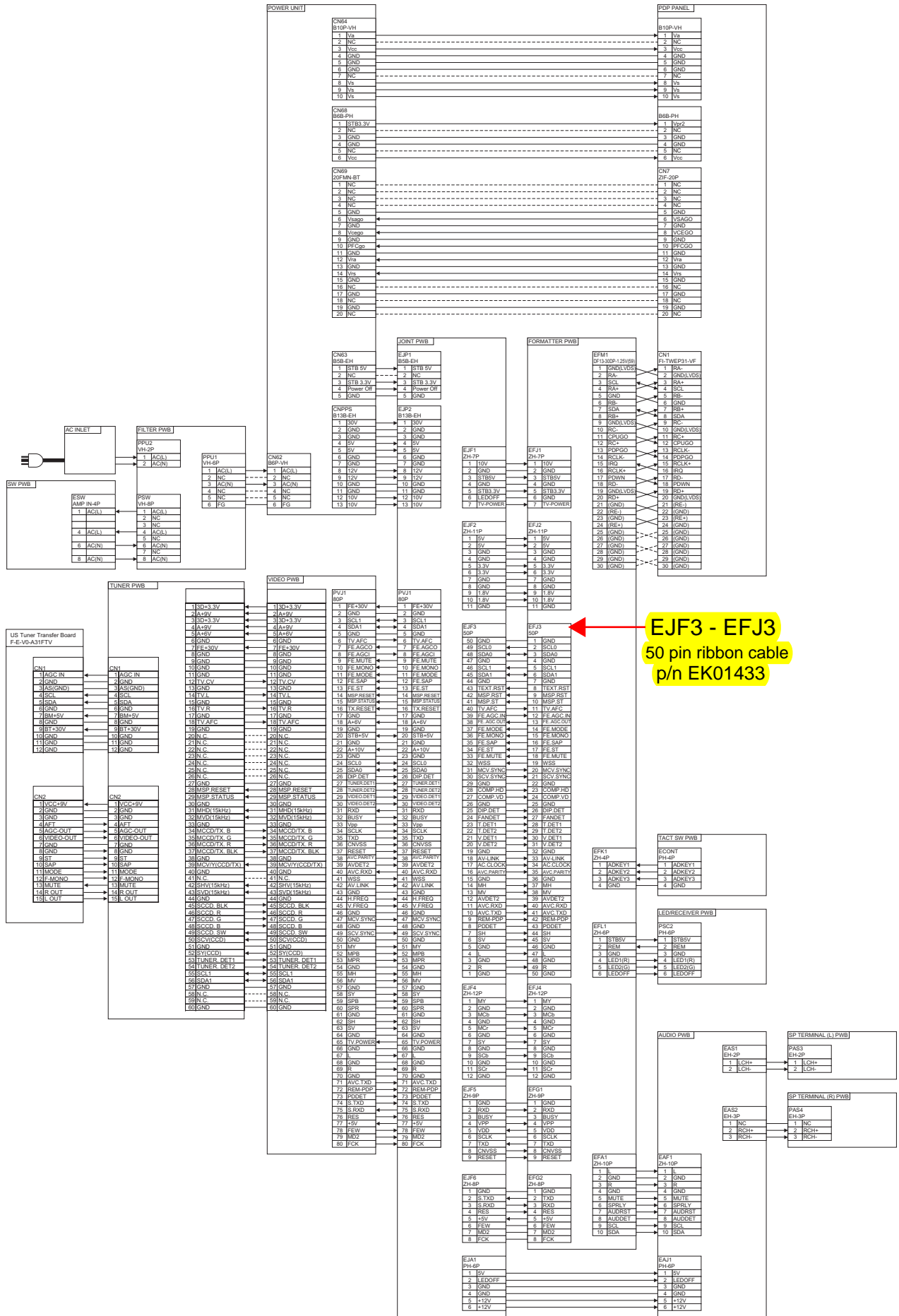

9. Wiring diagram

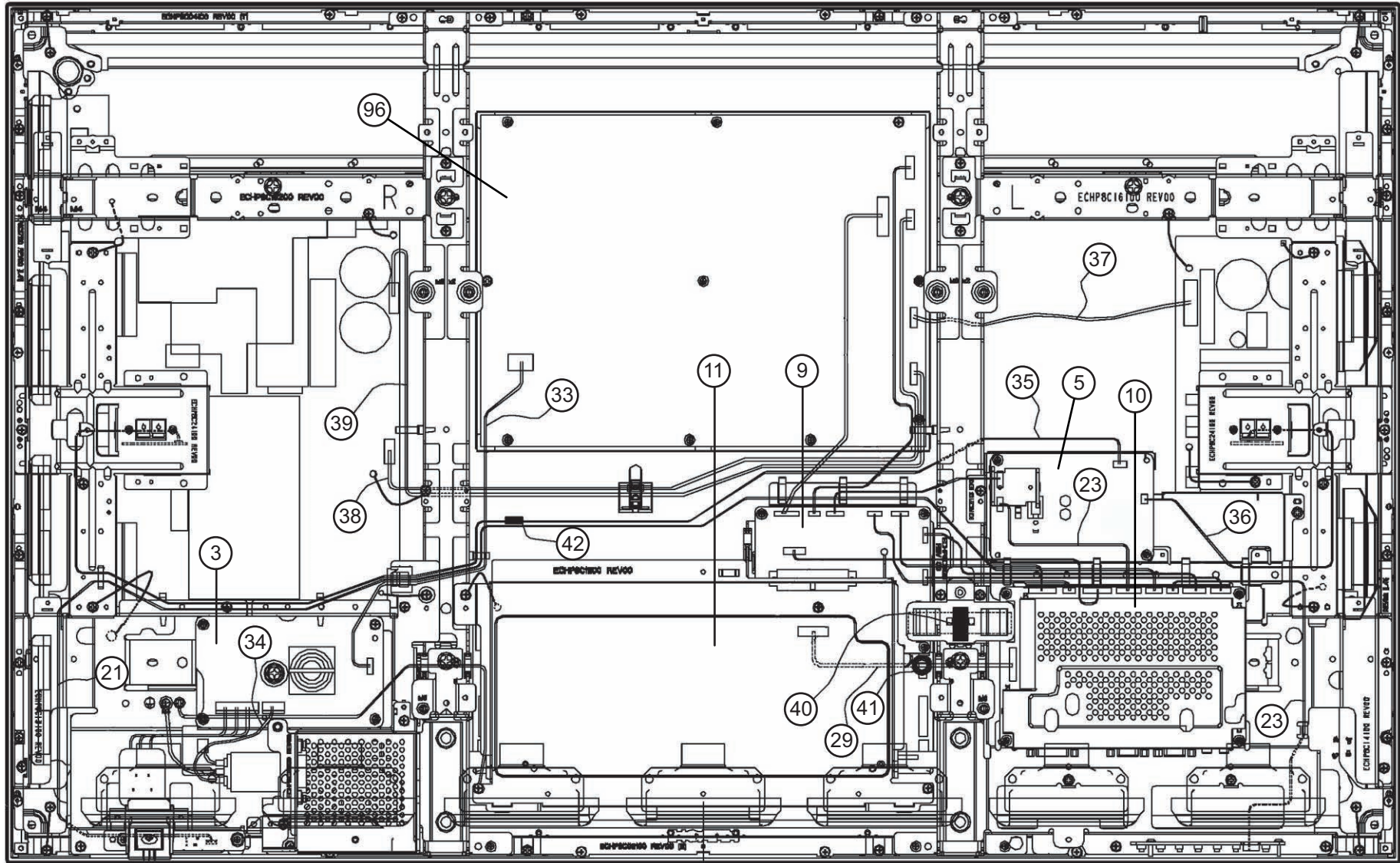

Circuit Board Part Numbers - Top Layer (Chassis Boards)

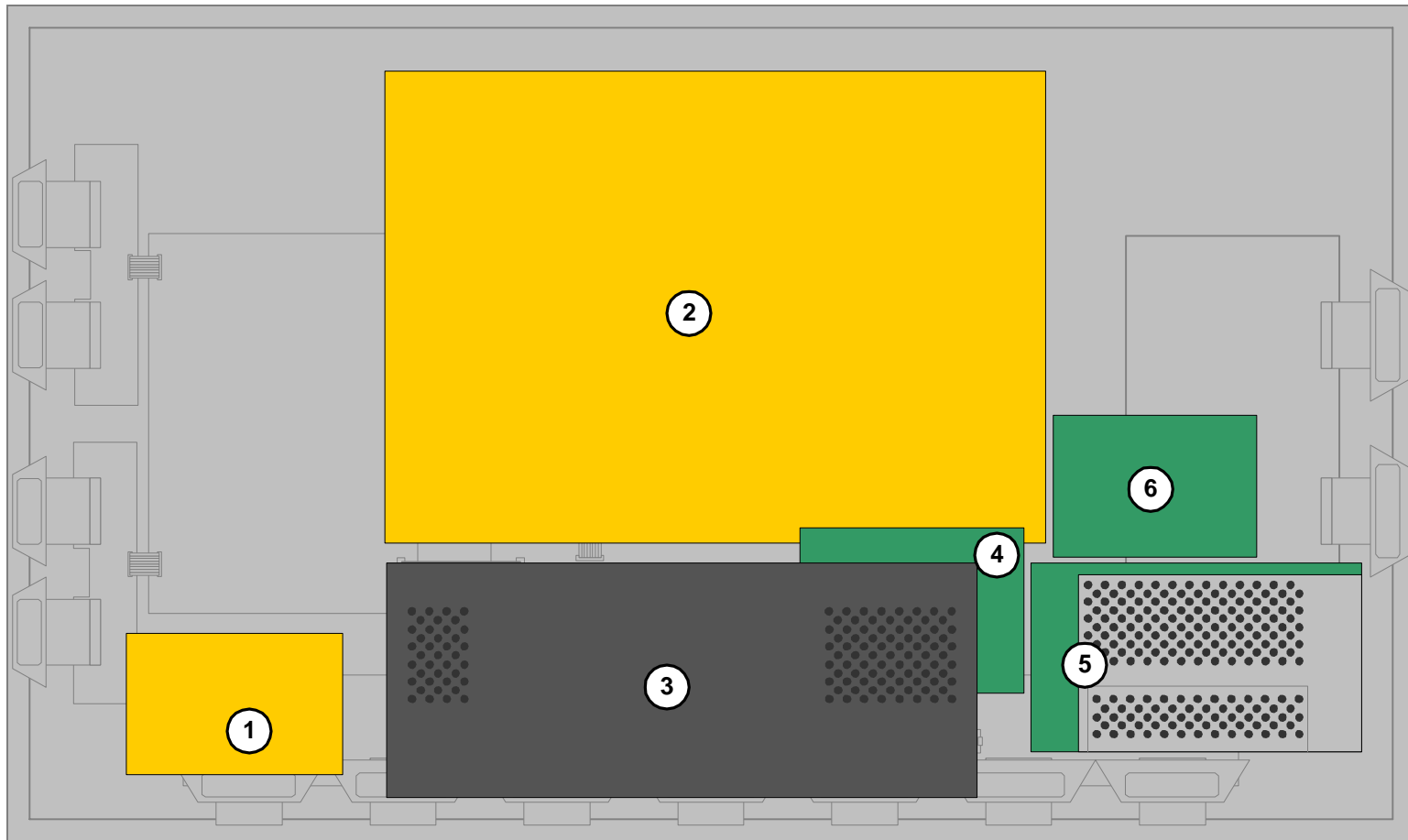

#	Description	42EDT41	42EDT41A
①	AC Filter PWB	TS05423	TS05423
②	Power Unit	HA01361	HA01361
③	Video Card	UX23571	UX23571
④	Joint PWB	TS05428	TS05428
⑤	Formatter PWB	TS05429	CS00891
⑥	Audio PWB	TS05263	TS05263

CMP420V1 and CMP420V2 use parts for 41EDT42

CMP420V1A and CMP420V2A use parts for 41EDT42A

Circuit Board Part Numbers - Bottom Layer (Panel Boards)

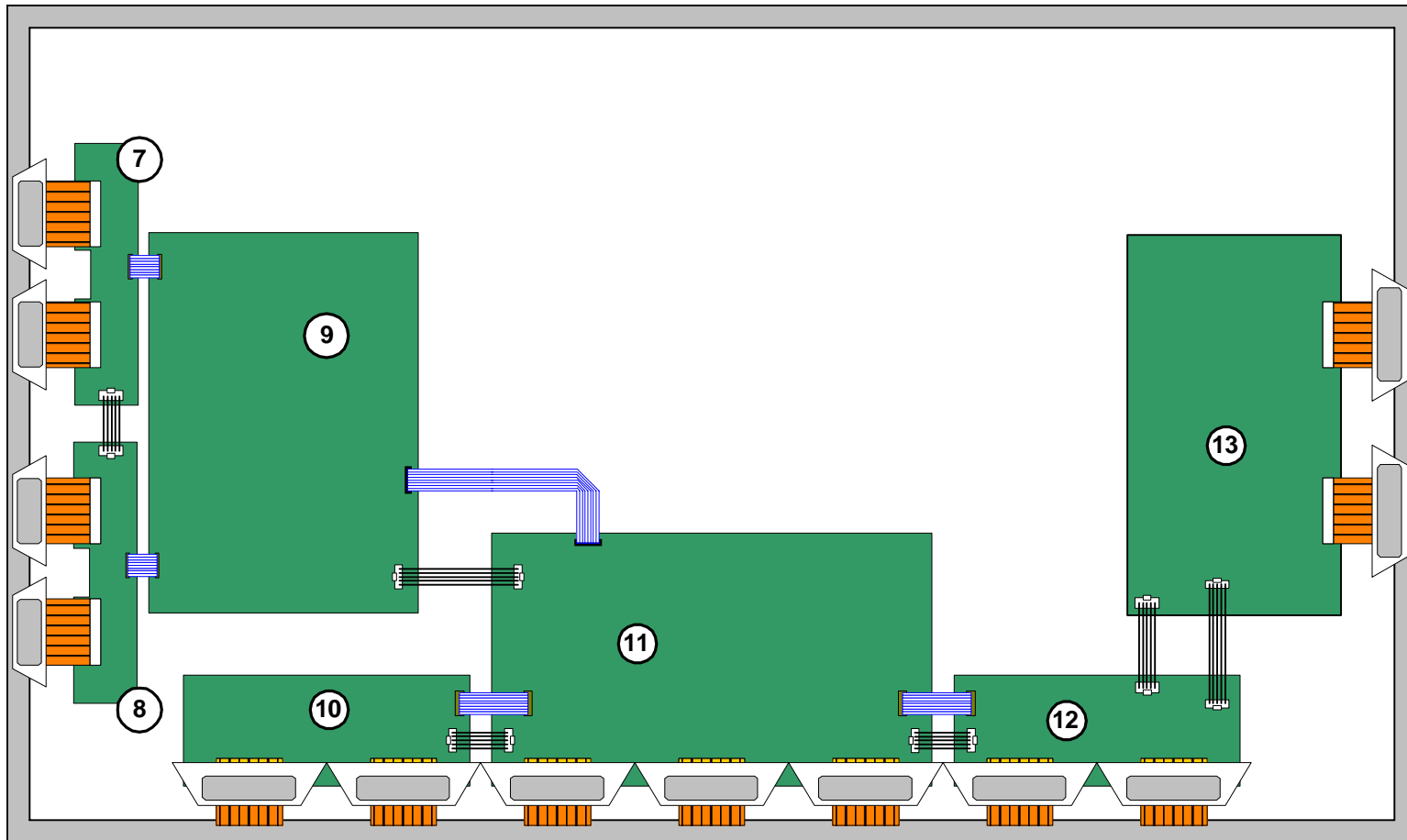

#	Description	All Models
⑦	Y-Driver Upper PWB	TS05672
⑧	Y-Drive Lower PWB	TS05673
⑨	Y-SUS PWB	TS05679
⑩	X-Drive Left PWB	TS05683
⑪	Control (LVDS) PWB	TS05678
⑫	X-Drive Right PWB	TS05682
⑬	Z-SUS PWB	TS05681

#	Description	All Models
Not Shown	Tact Key PWB	TS05422
	SW PWB	TS05424
	LED PWB	TS05425
	SP(L) PWB	TS05426
	SP(R) PWB	TS05427

Chassis Boards

Ribbon and Wire Assemblies

Circuit Board Part Numbers - Interconnect Cables

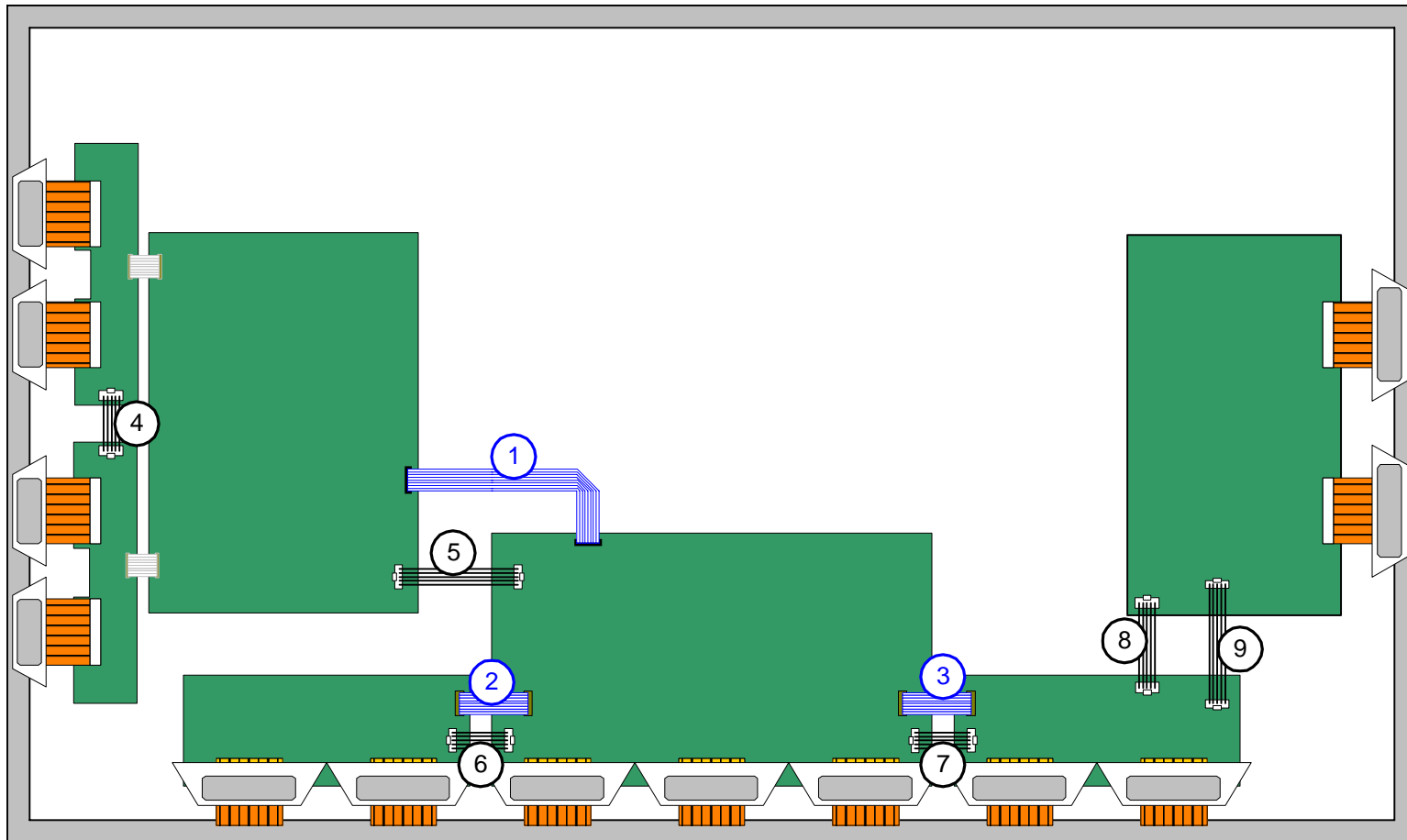

#	Description	All Models	#	Description	All Models
①	Ribbon Cable, Control PWB to Y-SUS PWB	TE05041	⑥	Wire Ass'y, Control PWB to X-Drive Left PWB	TE05051
②	Ribbon Cable, Control PWB to X-Drive Left PWB	TE05042	⑦	Wire Ass'y, Control PWB to X-Drive Right PWB	TE05051
③	Ribbon Cable, Control PWB to X-Drive Right PWB	TE05042	⑧	Wire Ass'y, X-Drive Right to Z-SUS PWB (short)	TE05053
④	Wire Ass'y, Y-Drive Upper PWB to Y-Drive Lower PWB	TE05051	⑨	Wire Ass'y, X-Drive Right to Z-SUS PWB (long)	TE05052
⑤	Wire Ass'y, Control PWB to Y-SUS PWB	TE05052			

10. Basic circuit diagram

[POWER BOARD Basic circuit diagram 1]

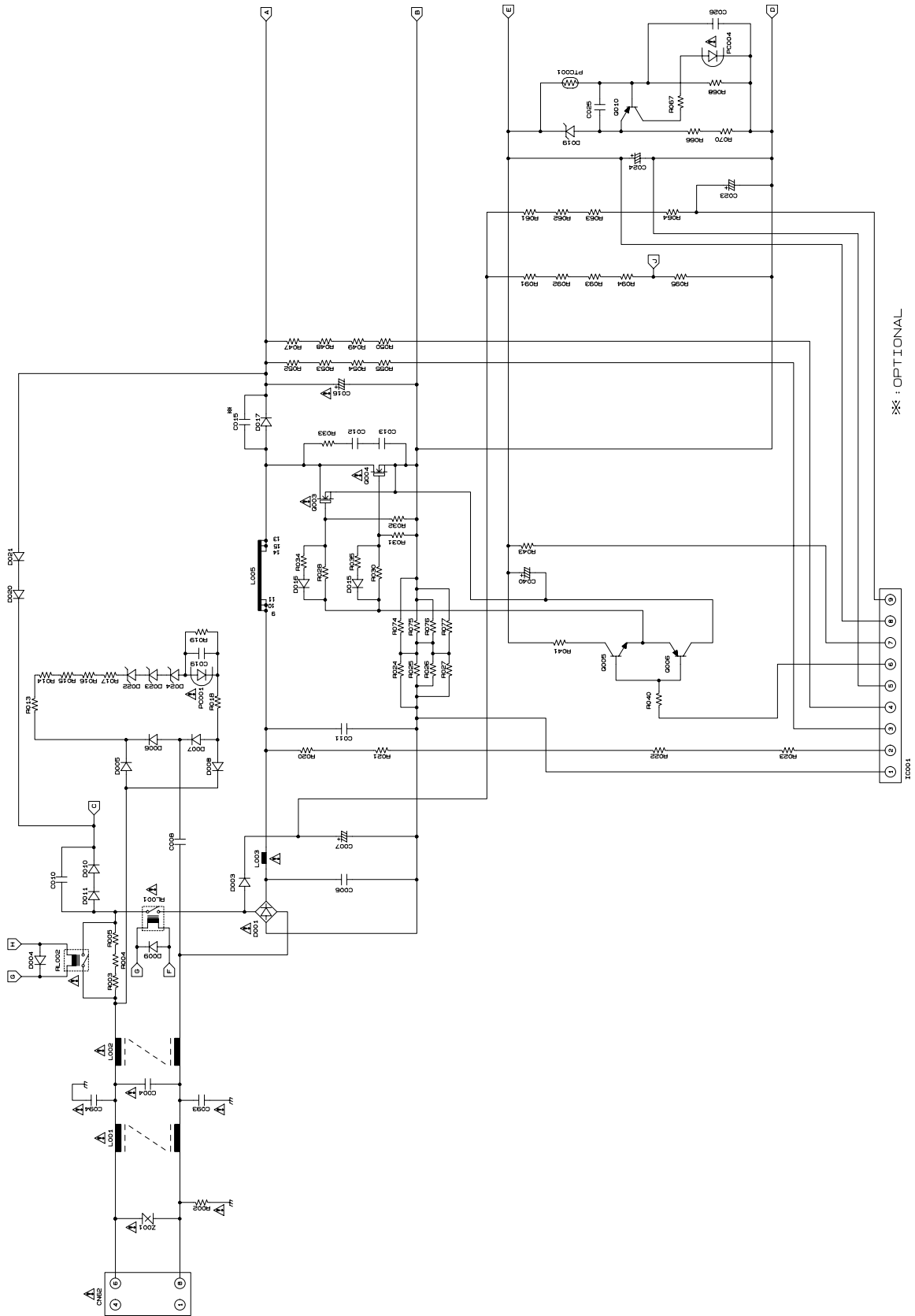

CMP420V1/CMP420V2/42EDT41 (PW1A)

[POWER BOARD Basic circuit diagram 3]

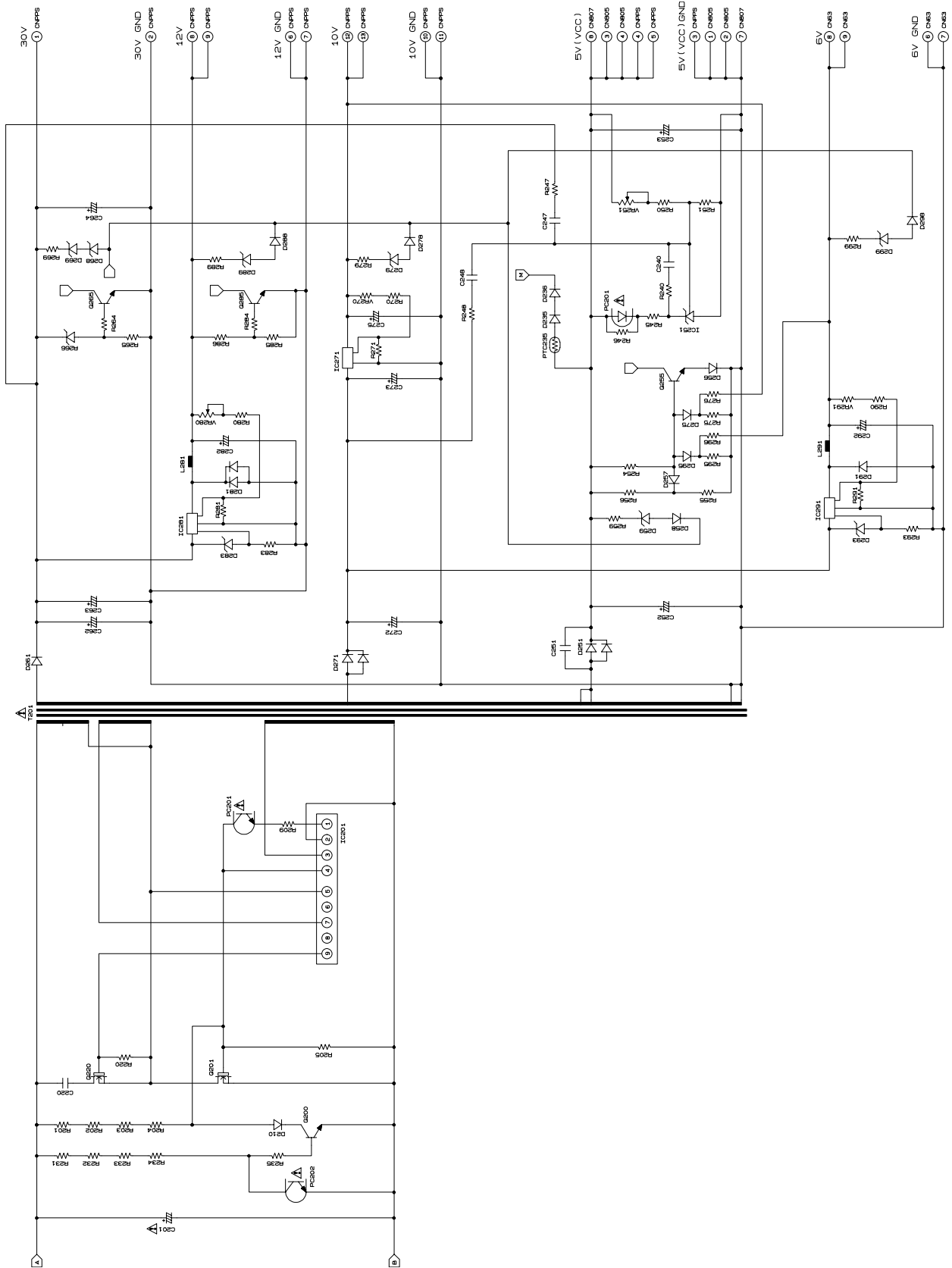

CMP420V1/CMP420V2/42EDT41 (PW1A)

[POWER BOARD Basic circuit diagram 4] [POWER BOARD Basic circuit diagram 5]

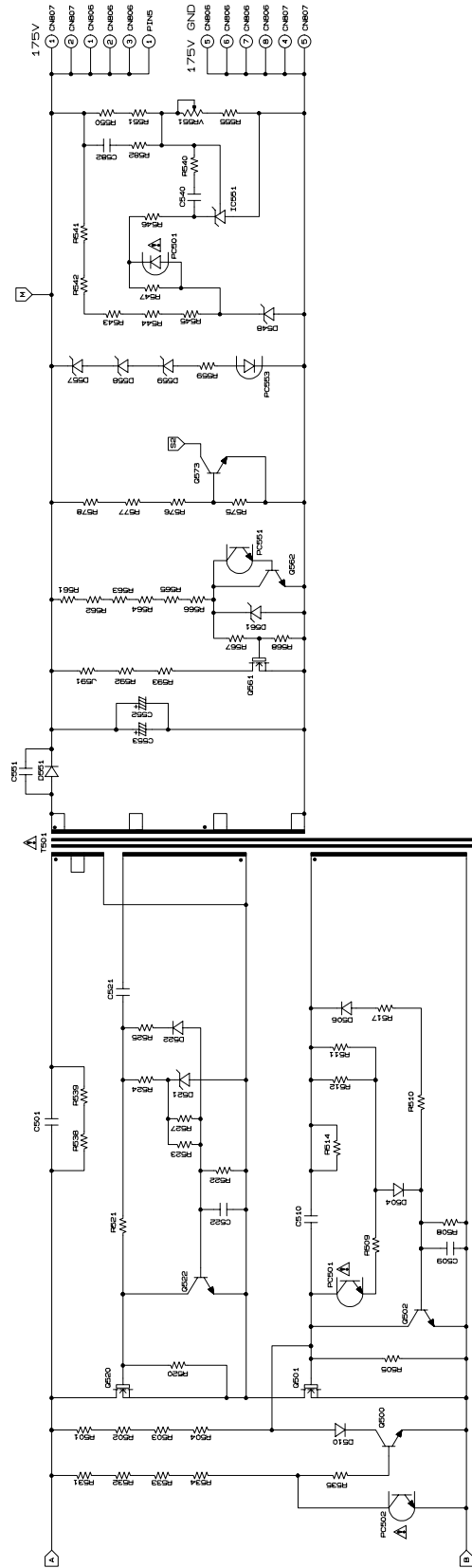
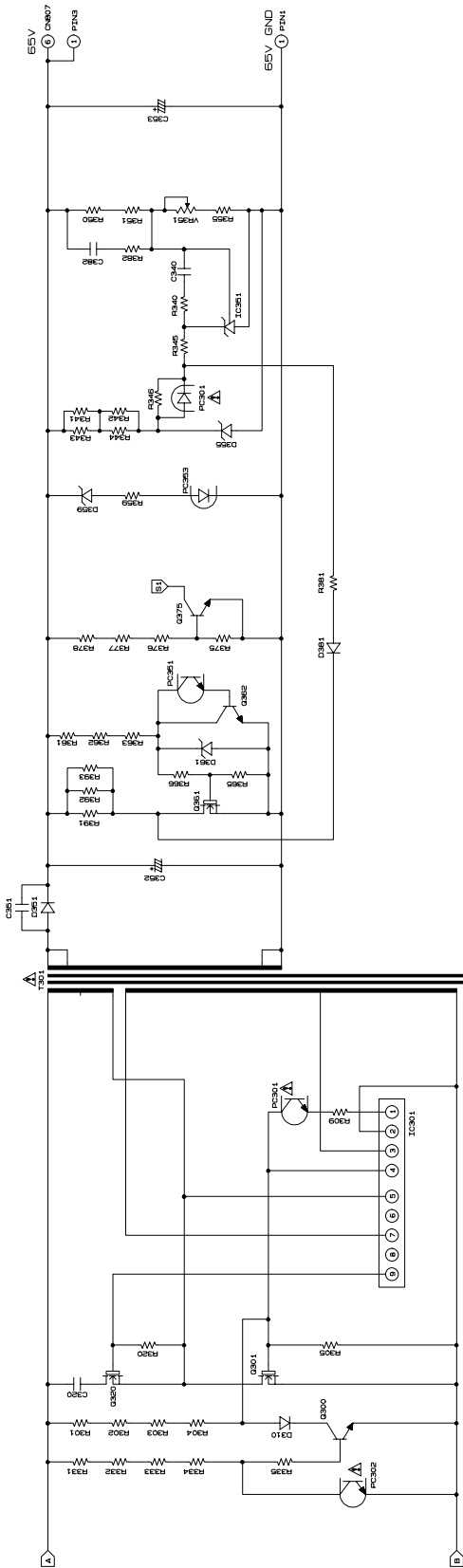

11. Printed wiring board diagram

[POWER BOARD Printed wiring board diagram 1]

UL MAKER MARK "UL" MARK "▲" MARK

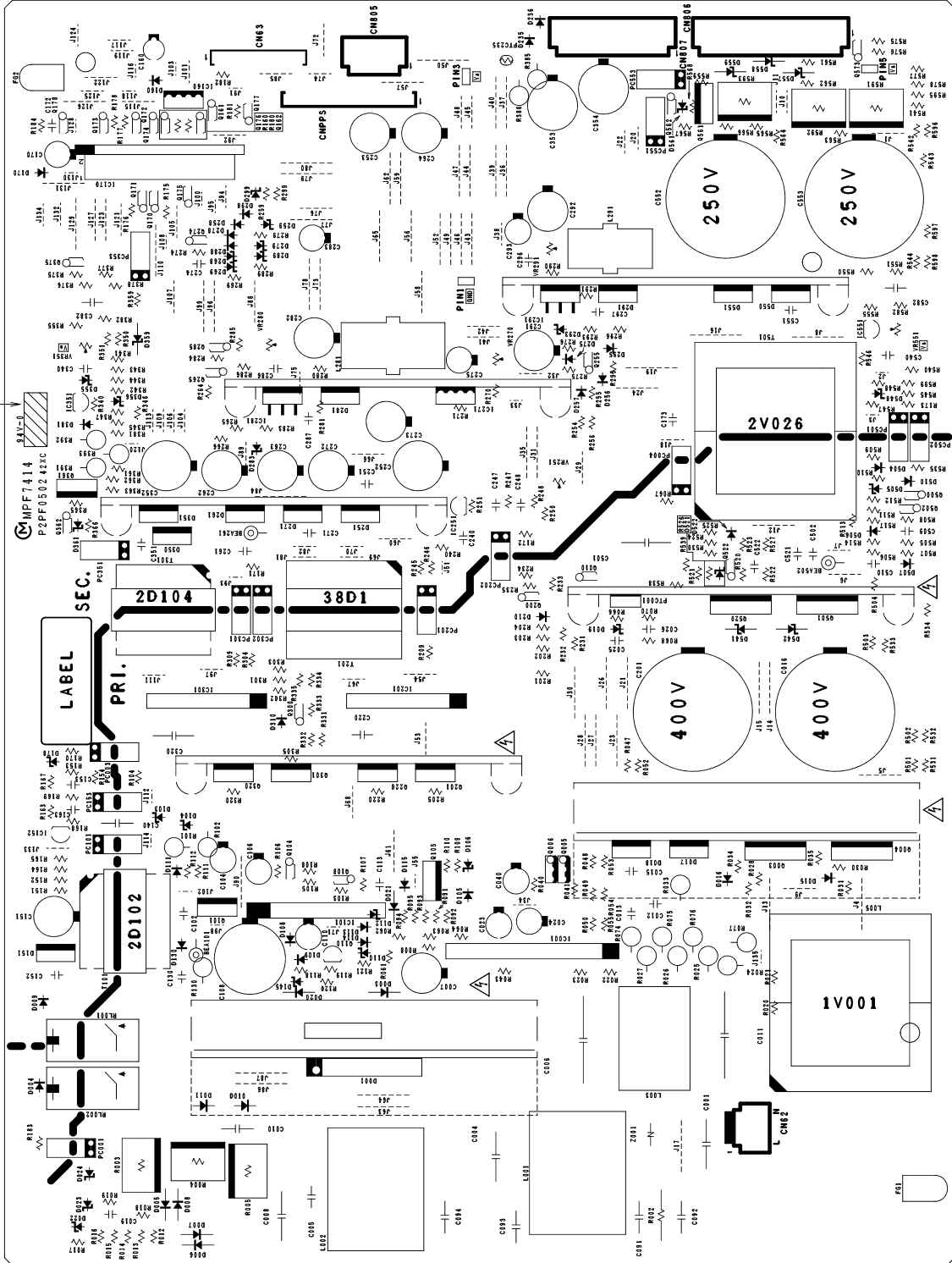

[POWER BOARD Printed wiring board diagram 2]

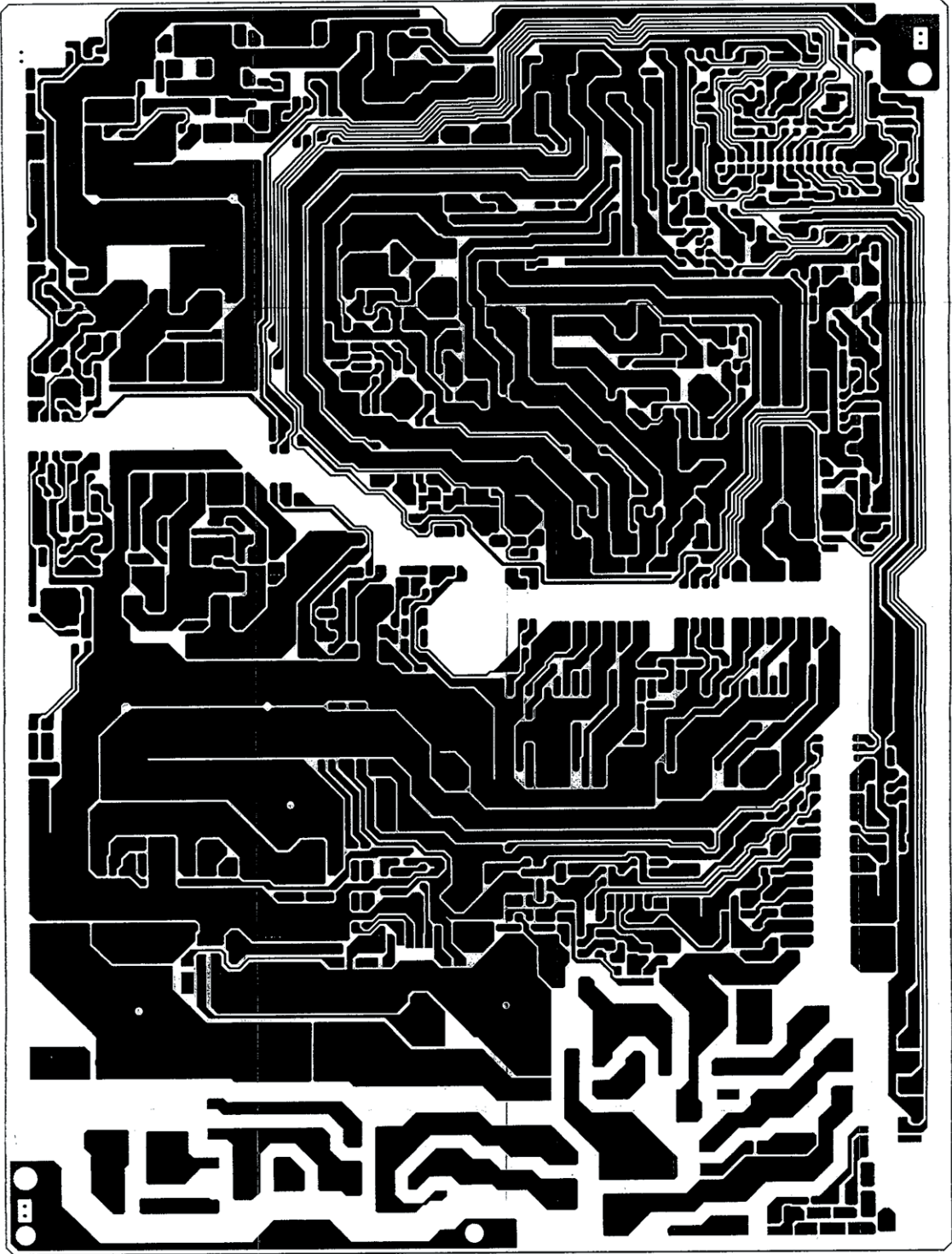

CMP420V1/CMP420V2/42EDT41 (PW1A)

[POWER BOARD Printed wiring board diagram 3]

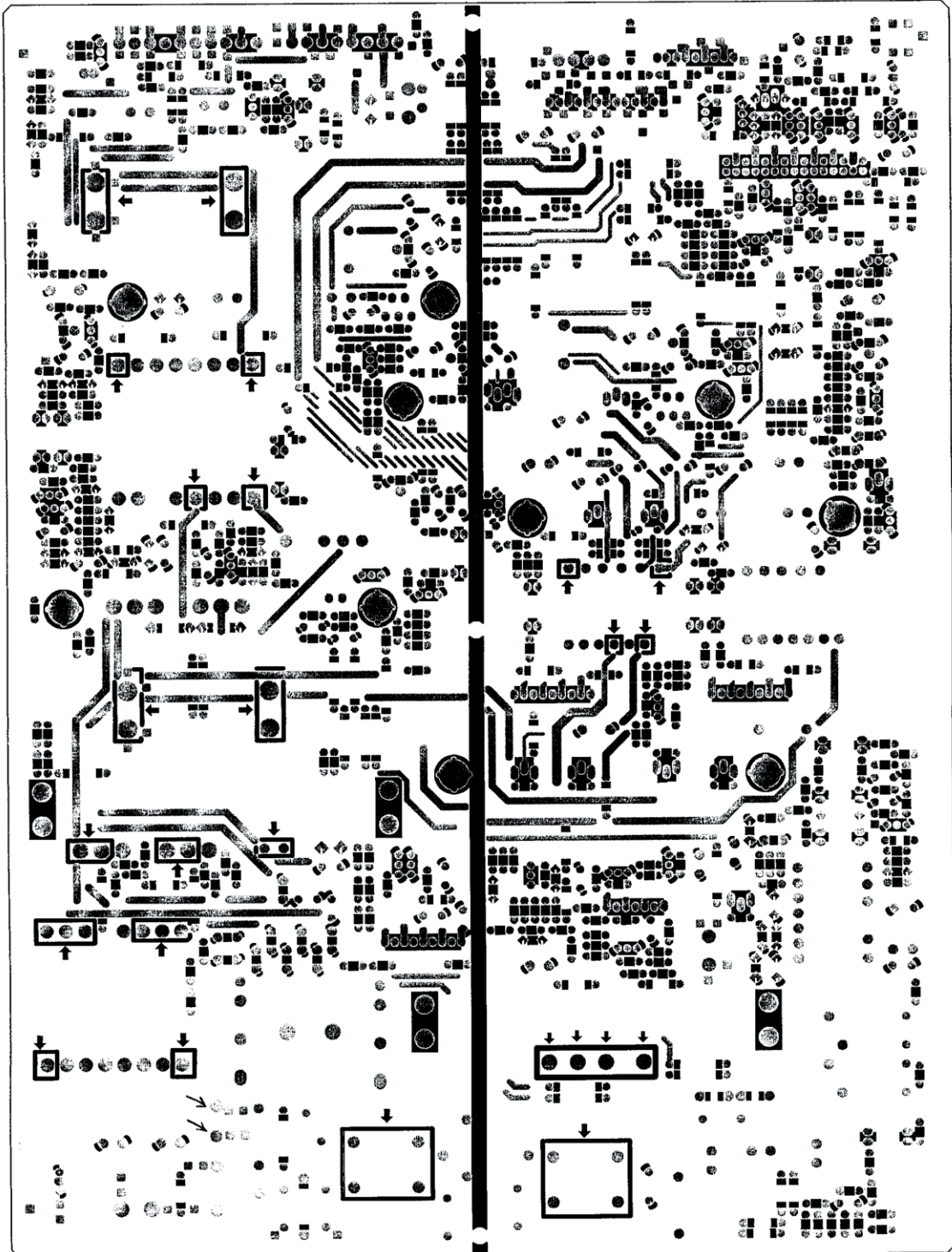

13. Replacement Parts list

PRODUCT SAFETY NOTE : Components marked with a \triangle have special characteristics important to safety. Before replacing any of these components, read carefully, the CAUTION FOR SAFETY of this Service Manual. Don't degrade the safety of the receiver through improper servicing.

SYMBOL No.	PART No.	DESCRIPTION	Specification	CMP420V2	CMP420V1	42EDT41
				Usage	Usage	Usage
1	TS05421	PDP FILT (*from Japan)	42 BRIDGESTONE PD4	○	○	○
2	TS05422	PCBA TACT KEY/B	VPD-K421 HP8C	○	○	○
3	TS05423	PCBA FILTER/B	VPD-P421 HP8C	○	○	○
4	TS05424	PCBA SW/B	VPD-421PW HP8C	○	○	○
5	TS05263	PCBA AUDIO/B	VPD-421AU HP8C	○	○	○
6	TS05425	PCBA LED/B	VPD-421LED HP8C	○	○	○
7	TS05426	PCBA SPL/B	VPD-421SPL HP8C	○	○	○
8	TS05427	PCBA SPR/B	VPD-421SPR HP8C	○	○	○
9	TS05428	PCBA JOINT/B	VPD-J421 HP8C	○	○	○
10	TS05429	FIRMWARE FORMATTER/B	VPD-L421 HP8A J88	○	○	○
11	TS05515	TUNER BOX ASSY J88	WHP8A MSV49 USA	-	-	○
12	TS05516	PCBA VIDEO/B	VPD-V421 SHT828	-	-	○
13	TS05517	PCBA TUNER-US/B	VPD-N421US WHP8AG	-	-	○
14	TS05518	PCBA US-T/B	VPD-T421US WHP8AG	-	-	○
15	TS05519	TUNER	HC00494 NTSC HIT HP8A	-	-	○
16	TS05531	SPEAKER	20 W 60HM CMPAS04S (R+L) 42"	-	-	○
17	TS05439	BEZEL (SILVER)	MCG28+MSV50 ABS 94	○	-	-
18	TS05441	BEZEL (BLACK)	MCG28+MBK33 ABS 94	-	○	-
19	TS05532	BEZEL	MCG28+MSV50 ABS 94HB	-	-	○
20	TS05442	LINE FILT	HP8C SUP-C14608F 8	○	○	○
21	TS05443	H-CON SET	HP8C FORMATTER EFL	○	○	○
22	TS05444	H-CON SET	HP8C FORMATTER EFK	○	○	○
23	TS05445	H-CON SET	HP8C FORMATTER EFA	○	○	○
24	TS05446	H-CON SET	HP8C FORMATTER EFJ	○	○	○
25	TS05447	H-CON SET	HP8C FORMATTER EFJ	○	○	○
26	TS05448	H-CON SET	HP8C FORMATTER EFJ	○	○	○
27	TS05449	H-CON SET	HP8C FORMATTER EFG	○	○	○
28	TS05451	H-CON SET	HP8C FORMATTER EFG	○	○	○
29	TS05452	H-CON SET	HP8C FORMATTER EFM	○	○	○
30	TS05453	H-CON SET	HP8C JOINT EJP1-PO	○	○	○
31	TS05454	H-CON SET	HP8C JOINT EJP2-PO	○	○	○
32	TS05455	H-CON SET	HP8C JOINT EJA1-AU	○	○	○
33	TS05456	H-CON SET	HP8C FILTER PPU1-P	○	○	○
34	TS05457	H-CON SET	HP8C FILTER PPU2-E	○	○	○
35	TS05458	H-CON SET	HP8C AUDIO EAS2-SP	○	○	○
36	TS05459	H-CON SET	HP8C AUDIO EAS1-SP	○	○	○
37	TS05461	H-CON SET	HP8C PANEL P1-POWE	○	○	○
38	TS05462	H-CON SET	HP8C PANEL P6-POWE	○	○	○
39	TS05463	H-CON SET	HP8C PANEL P5-POWE	○	○	○
40	TS05464	CORE	KC K5B FS 31X5X12-	○	○	○
41	TS05465	CLIP CORE	TDK ZCAT3035-1330	○	○	○
42	TS05466	CLIP CORE	TDK ZCAT2032-0930	○	○	○
43	TS05467	POWER PWB MTL	HP8C15 SECC T=0.8	○	○	○
44	TS05468	FITLER SUPPORT MTL	HP8C21 SUS304 T=0.	○	○	○
45	TS05469	AC MTL (A)	HP8C36 SECC T=0.8	○	○	○
46	TS05471	POWER SW HOLDER	HP8C46 SECC T=1.0	○	○	○
47	TS05472	CONTROL HOLDER	MBK32 ABS 94V0	○	○	○
48	TS05473	POWER BUTTON HOLDER	MCG64 ABS 94V0	○	○	○
49	TS05474	PANEL SUPPORT (A)	HP8C43	○	○	○
50	TS05475	PANEL SUPPORT (B)	HP8C44	○	○	○

CMP420V1/CMP420V2/42EDT41 (PW1A)

PRODUCT SAFETY NOTE : Components marked with a \triangle have special characteristics important to safety. Before replacing any of these components, read carefully, the CAUTION FOR SAFETY of this Service Manual. Don't degrade the safety of the receiver through improper servicing.

SYMBOL No.	PART No.	DESCRIPTION	Specification	CMP420V2	CMP420V1	42EDT41
				Usage	Usage	Usage
51	TS05476	PANEL SUPPORT (C)	HP8C45	○	○	○
52	TS05533	STAND SET	SMPG-218+MSV49 (HP8C)	-	-	○
53	TS05477	RC LENS	HM8C41 PMMA	○	○	○
54	TS05478	CONTROL BOTTON	MBK32 ABS 94V0	○	○	○
55	TS05479	POWER BUTTON	MCG64 ABS 94V0	○	○	○
56	TS05481	HANDGRIP	FOR CARTON R1	○	○	○
57	TS05482	AIR FILTER (T/B)	HP8C3A PU FOAM 10X	○	○	○
58	TS05483	AIR FILTER (L/R)	HP8C3A PU FOAM 10X	○	○	○
59	TS05484	GASKET	HP8C49 6X6X80	○	○	○
60	TS05485	GASKET	HP8C4A 6X10X80	○	○	○
61	TS05486	GASKET	HP8C4B 4X2X115	○	○	○
62	TS05487	GASKET	HP8C4C 4X2X175	○	○	○
63	TS05488	GASKET	HP8C4E 4X2X26	○	○	○
64	TS05489	EPE FOAM (B/L)	HP8C18	○	○	○
65	TS05491	EPE FOAM (B/R)	HP8C19	○	○	○
66	TS05492	EPE FOAM (T/L)	HP8C1A	○	○	○
67	TS05493	EPE FOAM (T/R)	HP8C1B	○	○	○
68	TS05534	EPE FOAM	HP8C3B	-	-	○
69	TS05535	EPE FOAM	HP8C3C	-	-	○
70	TS05494	PWR CORD	SP305X1.8MXIS14 SV	○	○	○
71	TS05495	BATT	LR6(SN) 2P X WHM 1	○	○	○
72	TS05496	CARTON-CMP420V1	C-HP8C-J88 FOR US	○	○	-
73	TS05538	CARTON-42EDT41	C-HP8C-J88 FOR US TV SILVER	-	-	○
74	TS05497	USER'S MANUAL	U-HP8C-J88 E+F+S F	○	○	-
75	TS05542	USER'S MANUAL	U-HP8C-J88 E+F+S FOR US TV	-	-	○
76	TS05498	IMAGE RETENTION NOTE	HP8C-L007 FOR CARTON	○	○	○
77	TS05499	MODEL LABEL-CMP720V1	HP8C-L006	-	○	-
78	TS05501	MODEL LABEL-CMP720V2	HP8C-L007 FOR CAR	○	-	-
79	TS05545	MODEL LABEL-42EDT41	HP8C-L007 FOR CARTON	-	-	○
80	TS05502	EPE BAG	HP8C-K001 42"PDP L	○	○	○
81	TS05503	PLASTIC RIVET	PR-04A BLACK N66	○	○	○
82	TS05504	PANEL PC FILM (B)	HP8C25 L=940	○	○	○
83	TS05505	PANEL PC FILM (R)	HP8C27 L=530	○	○	○
84	TS05506	CORE HOLDER	HP8C39 PC FILM T=0	○	○	○
85	TS05507	TL CLAMP	HV2847 NL66	○	○	○
86	TS05508	SCREW	M4X0.7+10P-ZK+2 WA	○	○	○
87	TS05369	SCREW SPECIAL	4#-40UNCX12.7 WASH	○	○	○
88	TS05509	WIRE SET	W7.6X90X4.1D(LOCK)	○	○	○
89	TS05511	FFC	50P G P0.5 PAD 0.5	○	○	○
90	TS05512	PWR MODU	MURATA MPF7414 PDP	○	○	○
91	HL01903	REMO CTRL	SMK (HL01903) BLK	○	○	-
92	HL02042	REMO CTRL	HOSIDEN PDP (HL02042)	-	-	○
93	TS05548	NET WIRE SET	4.3DX95X4.3D 144C/.12 TUBE	○	○	○
94	TS05549	NET SET	4.3DX45X4.3D 144C/.12 TUBE	○	○	○
95	TS05551	NET WIR SET	4.3DX15X4.3D 144C/.12 TUBE	○	○	○
96	HA01361	PCBA POWER BOARD	HPF7414	○	○	○

14. DC Voltages

BOARD	CONN	PIN	Vdc	NOTE	TO/FROM
Power PWB	CN63	1	4.97	Pink	Joint PWB, EJP1
		2	0.0		
		3	1.97		
		4	0.0		
		5	0.0		
		6	0.0		
		7	0.0		
		8	5.91		
		9	5.91		
	CNPPS	1	34.64	Orange	Joint PWB, EJP2
		2	0.0		
		3	0.0		
		4	5.17		
		5	5.17		
		6	0.0		
		7	0.0		
		8	12.54		
		9	12.54		
		10	0.0		
		11	0.0		
		12	10.18		
		13	10.18		
	CN805	1	0.0	Black	Y-SUS PWB, P6
		2	0.0	Brown	
		3	5.17	Red	
		4	5.17	Orange	
	CN807	1	190.7	White	Z-SUS PWB, P1
		2	190.7		
		3	0.0		
		4	0.0		
		5	0.0		
		6	65.2		
		7	0.0		
		8	5.17		
	CN806	1	190.7	White	Y-SUS PWB, P5
		2	190.7		
		3	190.7		
		4	0.0		
		5	0.0		
		6	0.0		
		7	0.0		
		8	0.0		
		9	0.0		
10		0.0			

BOARD	CONN	PIN	Vdc	NOTE	TO/FROM
Joint PWB	EJP1	1	4.97	Pink	Power PWB, CN63
		2	0.0		
		3	1.97		
		4	0.0		
		5	0.0		
		6	0.0		
		7	0.0		
		8	5.91		
		9	5.91		
	EJP2	1	34.64	Orange	Power PWB, CNPPS
		2	0.0		
		3	0.0		
		4	5.17		
		5	5.17		
		6	0.0		
		7	0.0		
		8	12.54		
		9	12.54		
		10	0.0		
		11	0.0		
		12	10.18		
		13	10.18		
	EJA1	1	5.9	Blue	Audio PWB, EAJ1
		2	0.0		
		3	0.0		
		4	0.0		
		5	12.54		
		6	12.54		
	EJF1	1	9.81	Black	Formatter PWB, EFJ1
		2	0.0		
		3	4.95		
		4	0.0		
		5	1.96		
		6	0.0		
		7	4.34		
	EJF2	1	5.89		Formatter PWB, EFJ2
		2	5.89		
		3	0.0		
		4	0.0		
		5	3.29		
		6	3.29		
		7	0.0		
		8	0.0		
9		1.79			
10		1.79			
11		0.0			

14. DC Voltages

BOARD	CONN	PIN	Vdc	NOTE	TO/FROM	BOARD	CONN	PIN	Vdc	NOTE	TO/FROM	
Joint PWB	EJF5	1	0.0	White	Formatter PWB, EFG1	Formatter PWB	EFA1	1	3.6	Purple	Audio PWB, EAF1	
		2	4.88					2	0.0			
		3	0.0					3	3.6			
		4	0.0					4	0.0			
		5	4.88					5	0.0			
		6	0.471					6	0.0			
		7	4.88					7	4.85			
		8	0.0					8	4.85			
		9	4.88					9	4.85			
	10	4.85		10	4.85							
	EJF6	1	0.0	Gray	Formatter PWB, EFG2	EFG1	1	0.0	White	Joint PWB, EJF1		
		2	4.99				2	4.88				
		3	4.99				3	0.0				
		4	4.99				4	0.0				
5		4.99		5			4.88					
6		0.0		6			0.471					
7		4.99		7			4.88					
8		4.99		8			0.0					
Audio PWB	EJA1	1	5.9	Blue	Joint PWB, EJA1		EFG2	1	0.0		Gray	Joint PWB, EJF2
		2	0.0			2		4.99				
		3	0.0			3		4.99				
		4	0.0			4		4.99				
		5	12.54			5		4.99				
		6	12.54			6		0.0				
	EAF1	1	3.6	Purple	Formatter PWB, EFA1	EFJ1		1	9.81	Black	Joint PWB, EJF5	
		2	0.0					2	0.0			
		3	3.6				3	4.95				
		4	0.0				4	0.0				
		5	0.0				5	1.96				
		6	0.0				6	0.0				
Formatter PWB	EFG1	7	4.85		Joint PWB, EJF6		EFJ2	1	0.0	Gray		Joint PWB, EJF6
		8	4.85			2		4.99				
		9	4.85			3		4.99				
		10	4.85			4		4.99				
		1	0.0	Gray		5		4.99				
		2	4.99			6		0.0				
		3	4.99			7		4.99				
		4	4.99			8		4.99				
	EFA1	1	9.81	Black	Control Panel	EFK1	1	4.86	Yellow	Control Panel		
		2	0.0				2	4.86				
		3	4.95				3	4.86				
		4	0.0				4	0.0				
	EFL1	1	4.86		Front Panel indicators	EFL1	1	4.86		Front Panel indicators		
		2	4.21				2	4.21				
3		0.0		3			0.0					
4		4.03		4			4.03					
5		0.0		5			0.0					
6		0.0		6			0.0					

Joint PWB—DC Voltages

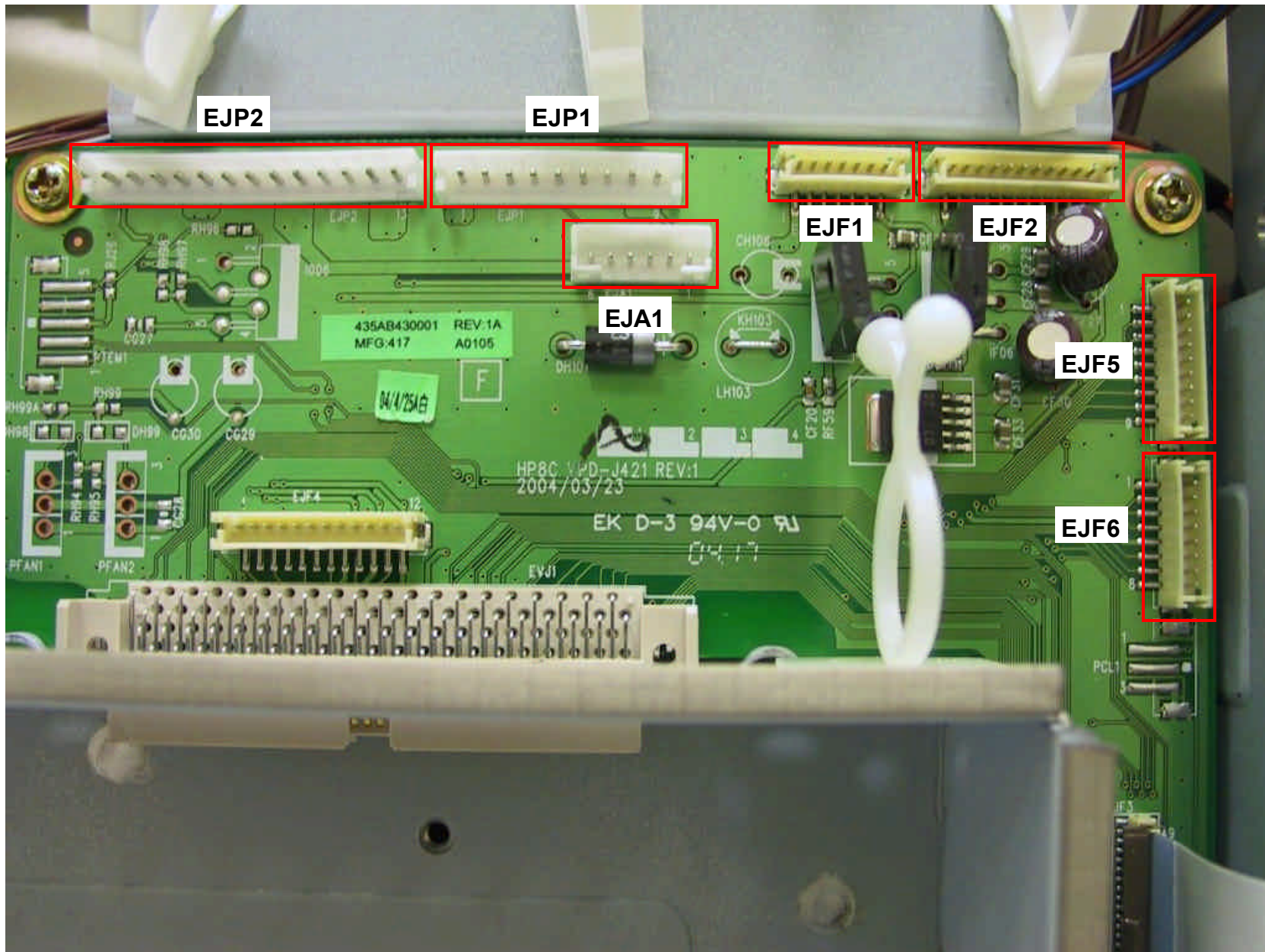

Audio PWB—DC Voltages

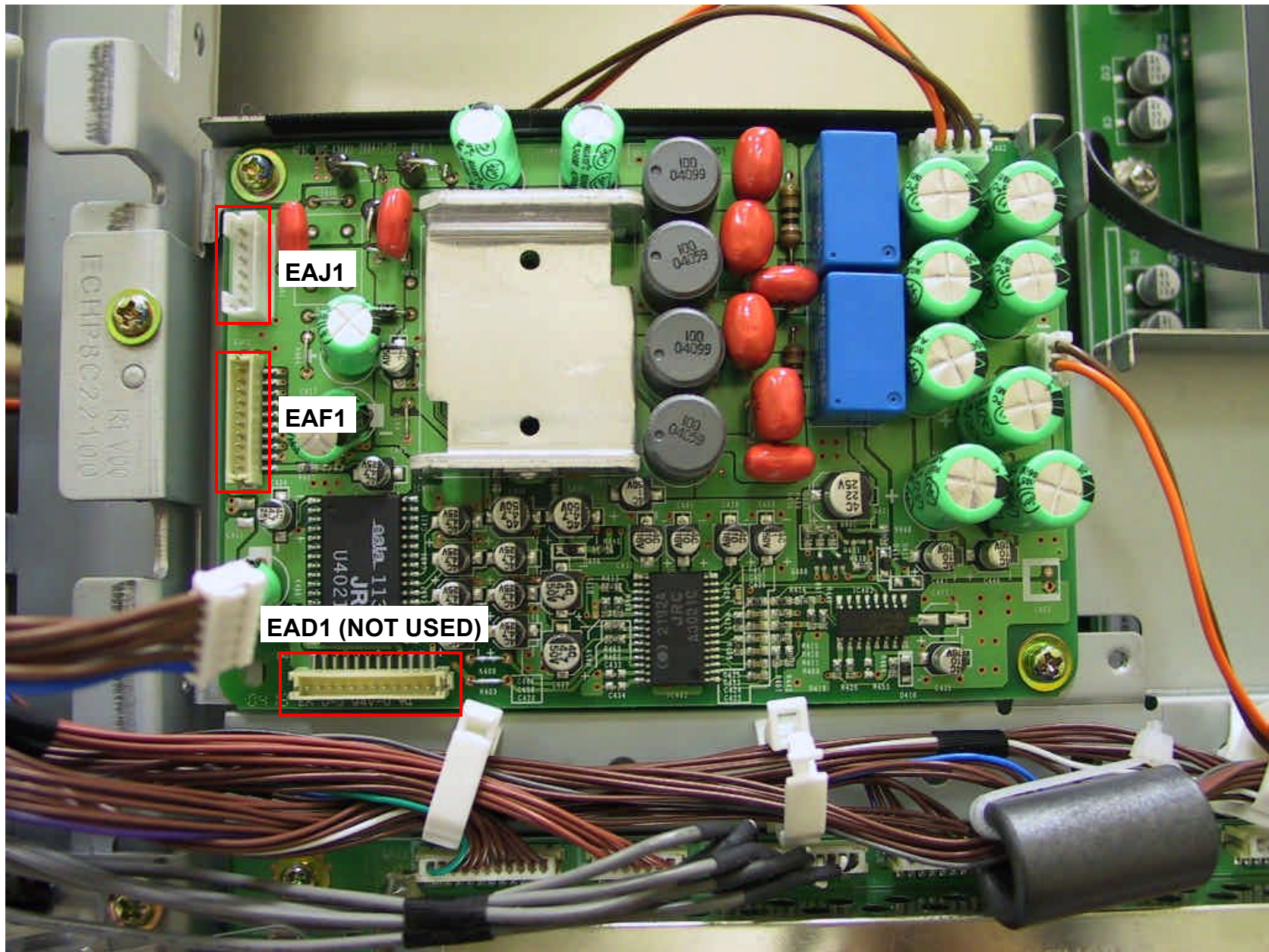

Formatter PWB—DC Voltages

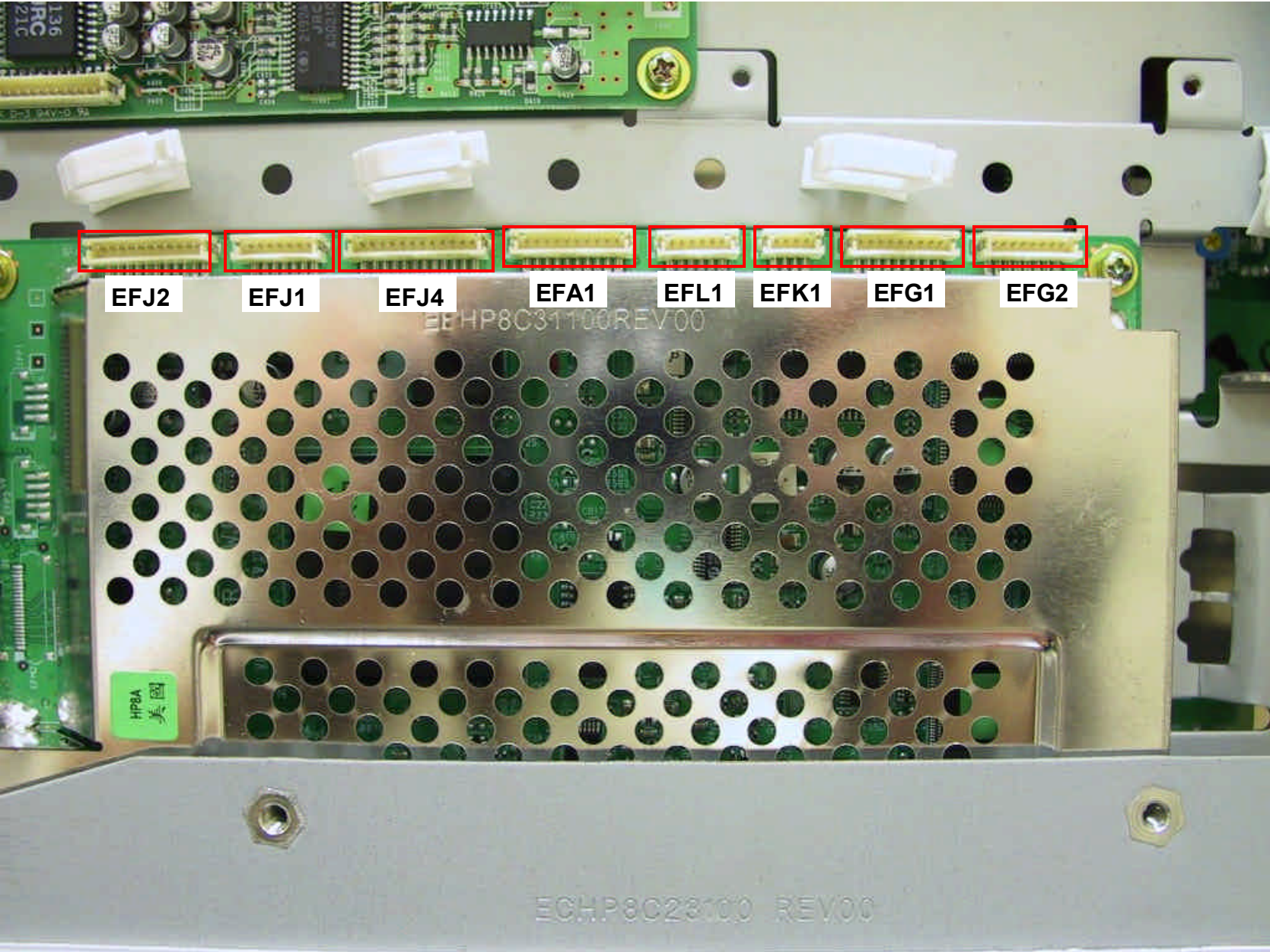

ZSUS PWB—DC Voltages

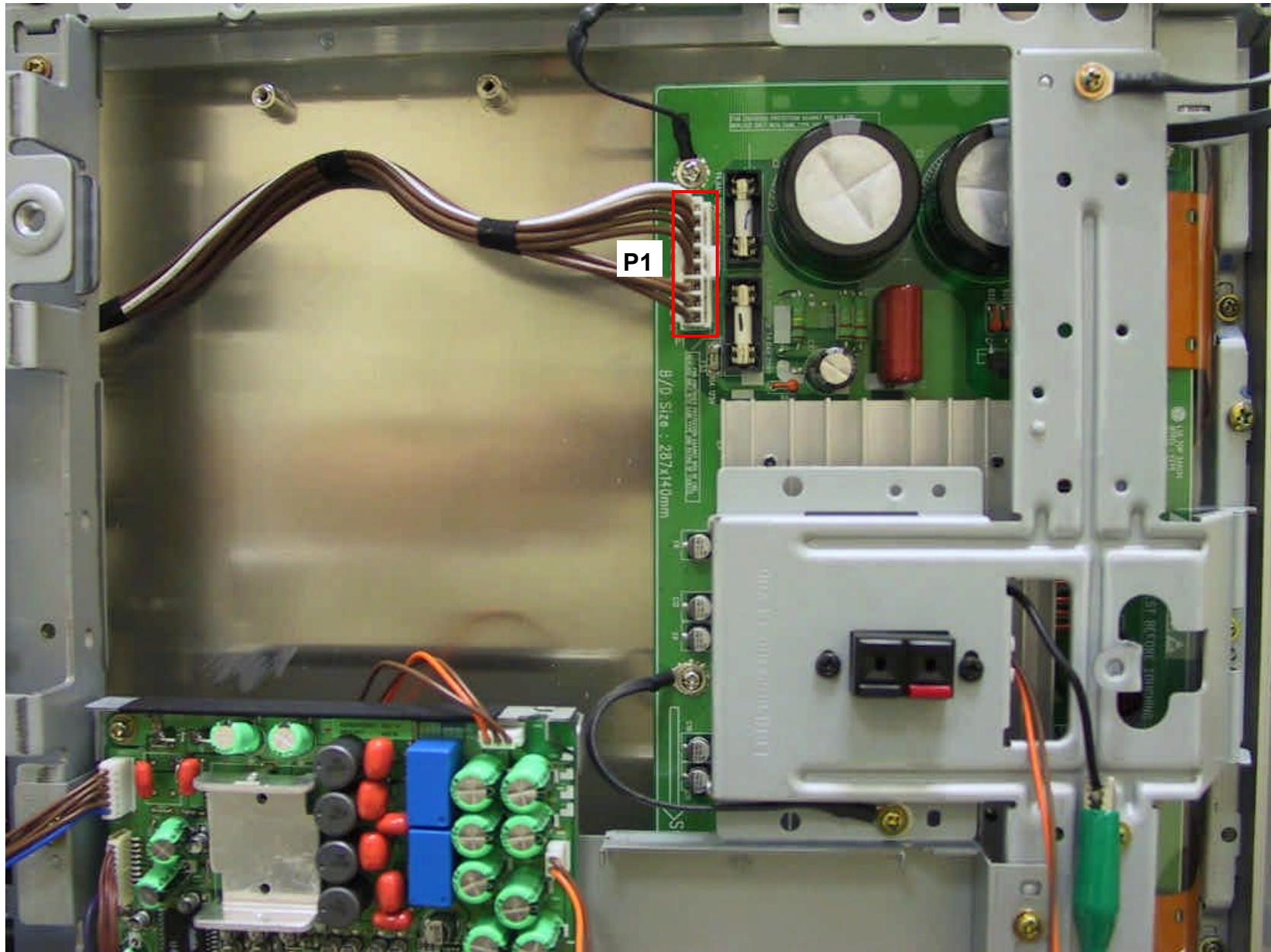

Caution

Make sure the monitor power is switched off (with the standby/ receive lamp switched off or red) before you connect or disconnect the speaker cables.

Attach the speaker systems to the monitor.

1 Attach the speaker brackets to the speaker systems.

Attach the screws in a position that allows you to read the speaker holder orientation markers (R), (L).

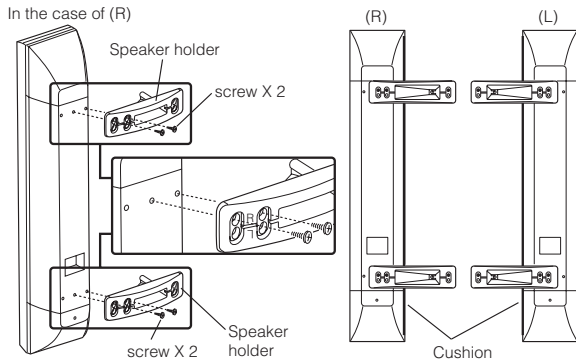

Notice

Use of cushions

In some cases, there can be a gap between the main unit and the speaker. You can attach the cushions provided to the side of the speaker system, if desired, to eliminate the gap.

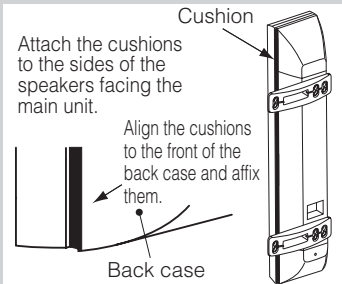

2 Attach the speaker systems to the monitor.

Remove two screws on each side of the monitor as shown and keep them for re-install. Loosen two screws on each side of the monitor as shown so that the speaker holders can be slide on to them. Insert the loosened screws into the engaging holes of the speaker holders that are attached to the speaker system, and slide the screws downwards. Next, use the previously-removed screws to fasten the speaker holders into the mounting holes in the monitor. Tighten the four screws to secure.

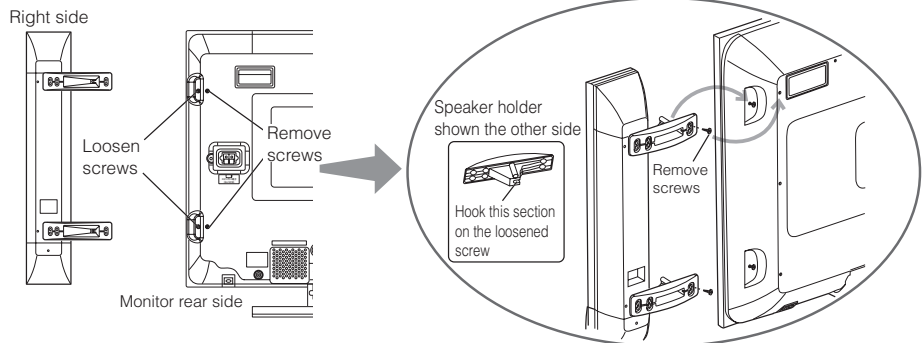

3 Attach the connection cables to the speaker system.

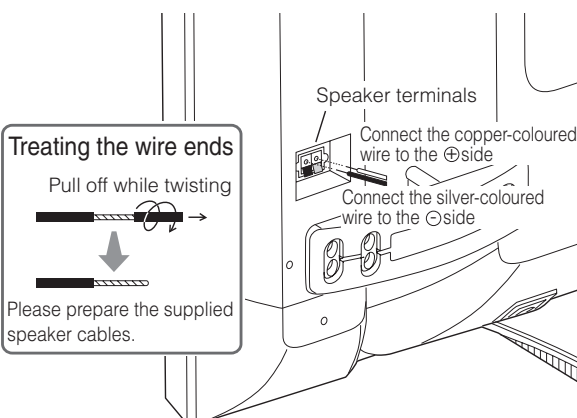

Treating the wire ends
Pull off while twisting
Please prepare the supplied speaker cables.

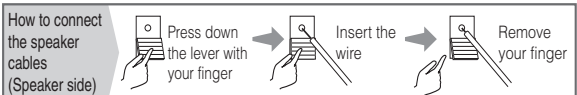

4 Attach the speaker connection cables to the monitor.

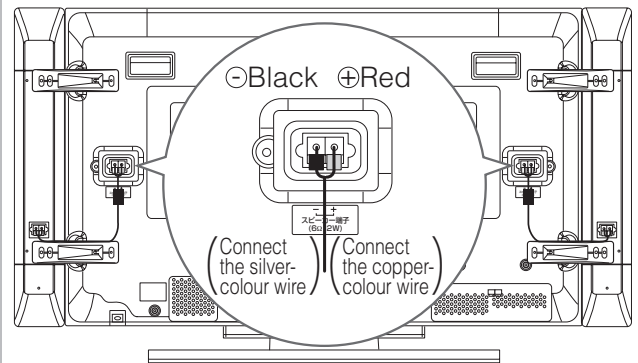

Caution required

Be sure to insert the speaker cables securely. Lock the connection terminal level securely.

HITACHI

Hitachi Plasma Display Tabletop Stand

Model

CMPAD15

Installation Instructions

Thank you for purchasing the Hitachi Plasma Display Tabletop Stand.
To ensure correct usage, please read this instruction manual thoroughly. After reading, please store this manual in a safe place for future reference.

This plasma display tabletop stand is for use only with the following models:

CMP4201* CMP4202* CMP4203* 42PMA400*

- Request an installation specialist to install this unit.
- This company assumes absolutely no responsibility for injuries and damages that may occur due to improper installation and handling.

Parts Configuration Chart

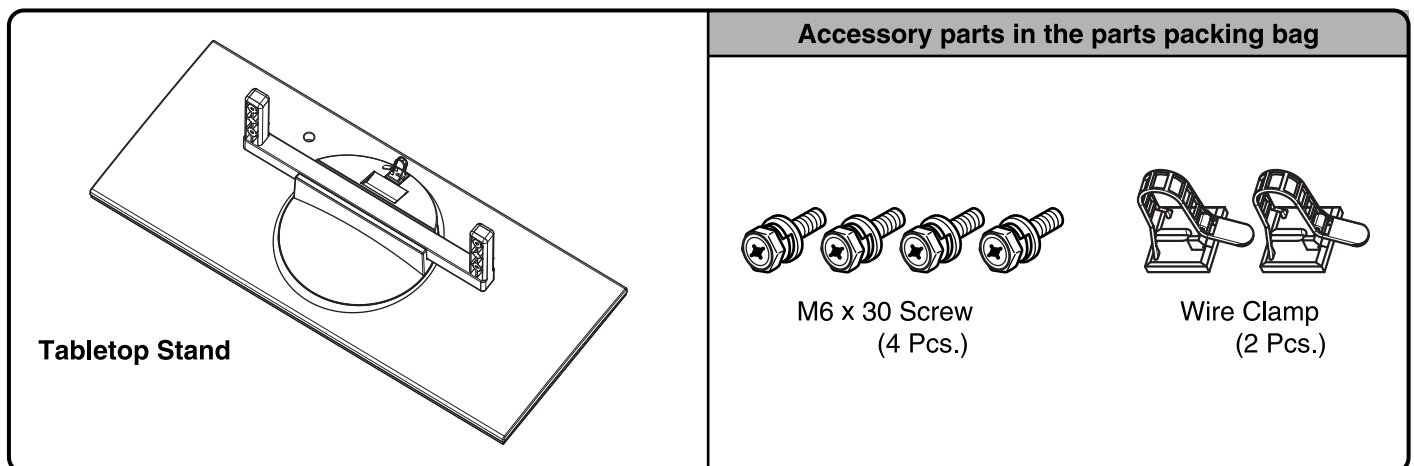

Usage cautions to ensure correct usage

Symbols

- The following symbols are used to ensure safe usage of the product, to prevent danger to yourself and other parties and to prevent damage to property.



WARNING

- This symbol indicates that incorrect handling due to ignoring this symbol can result in the possibility of personal injury or even death.



CAUTION

- This symbol indicates that incorrect handling due to ignoring this symbol can result in the possibility of personal injury and physical damage.



- This symbol indicates additional cautions (including warnings).



- This symbol indicates forbidden actions.



- This symbol indicates required actions.

Dimensions of After Assembly

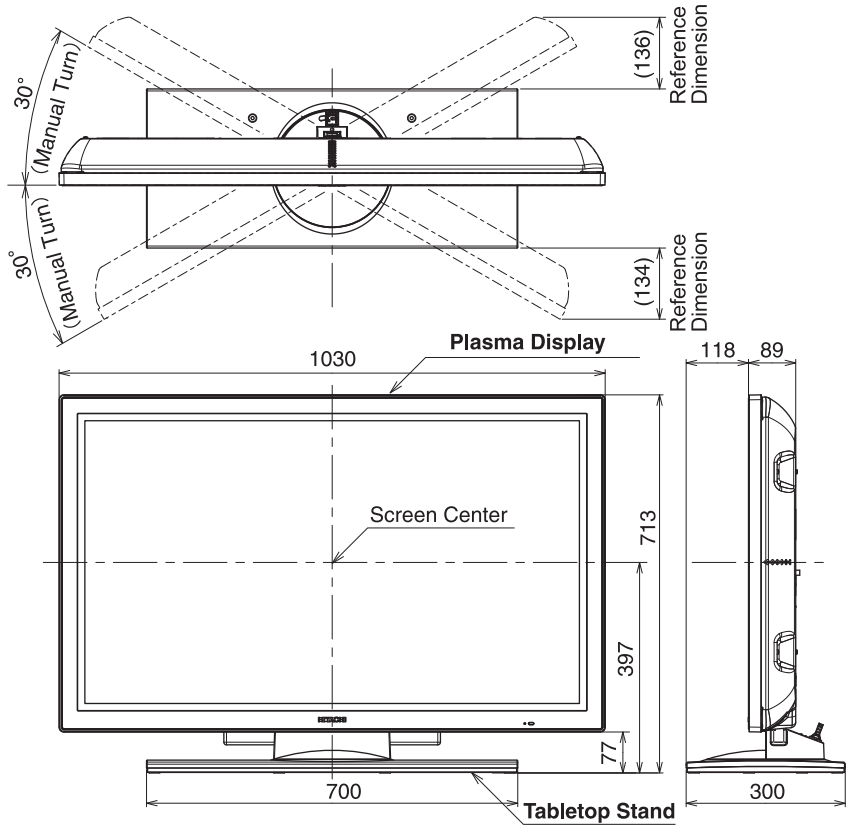

Product Specifications

External Dimensions	700 (W) x 185 (H) x 300 (D) mm
Mass	5.6 kg
Main Material (Surface Treatment)	Base Cover and Turn Cap: ABS (Painting) Support: Aluminum Bottom Cover: Steel (Plating)

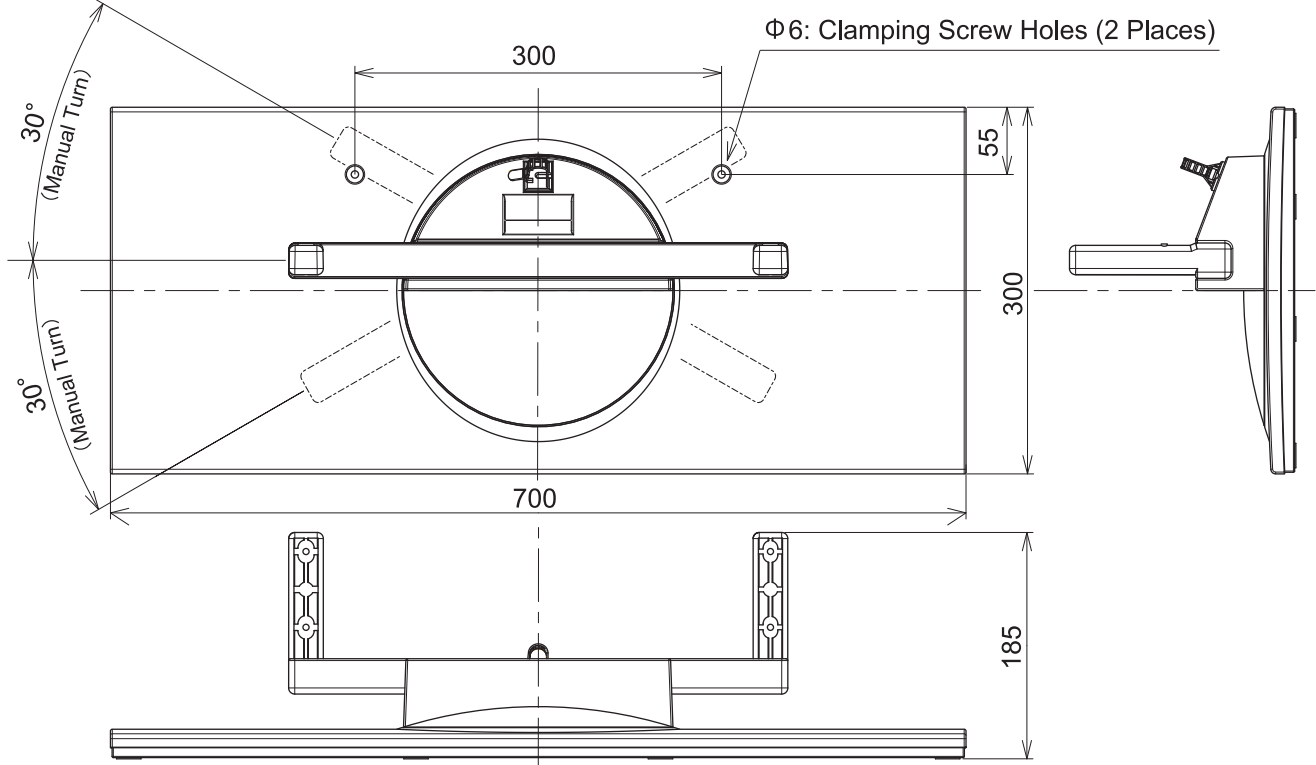

MEMO

HITACHI

**CMP420V1/CMP420V2 YK No.009E
42EDT41**

Digital Media Division