

300mA SmartOR™ Regulator with V_{AUX} Drive

Features

- Automatic detection of V_{CC} input supply
- Glitch-free output during supply transitions
- Built-in hysteresis during supply selection
- 300mA output maximum load current
- Overload current protection
- Short circuit current protection
- Operates from either V_{CC} or V_{OUT}
- 8-pin SOIC package

Applications

- PCI adapter cards
- Network Interface Cards (NIC's)
- Dual power systems
- Systems with standby capabilities

Product Description

The SmartOR™ CMPWR130 is a low dropout regulator that delivers up to 300mA of load current at a fixed 3.3V output. An internal threshold level (TYP 4.1V) is used to prevent the regulator from being operated below dropout voltage. The device continuously monitors the input supply and will automatically disable the regulator when V_{CC} falls below the threshold level. When the regulator is disabled, the control signal "Drive" (Active Low) is enabled, which allows an external PMOS switch to power the load from an auxiliary 3.3V supply.

When V_{CC} is restored to a level above the select threshold, the control signal for the external PMOS switch is disabled and the regulator is once again enabled.

All the necessary control circuitry needed to provide a smooth and automatic transition between the supplies has been incorporated. This allows V_{CC} to be dynamically switched without loss of output voltage.

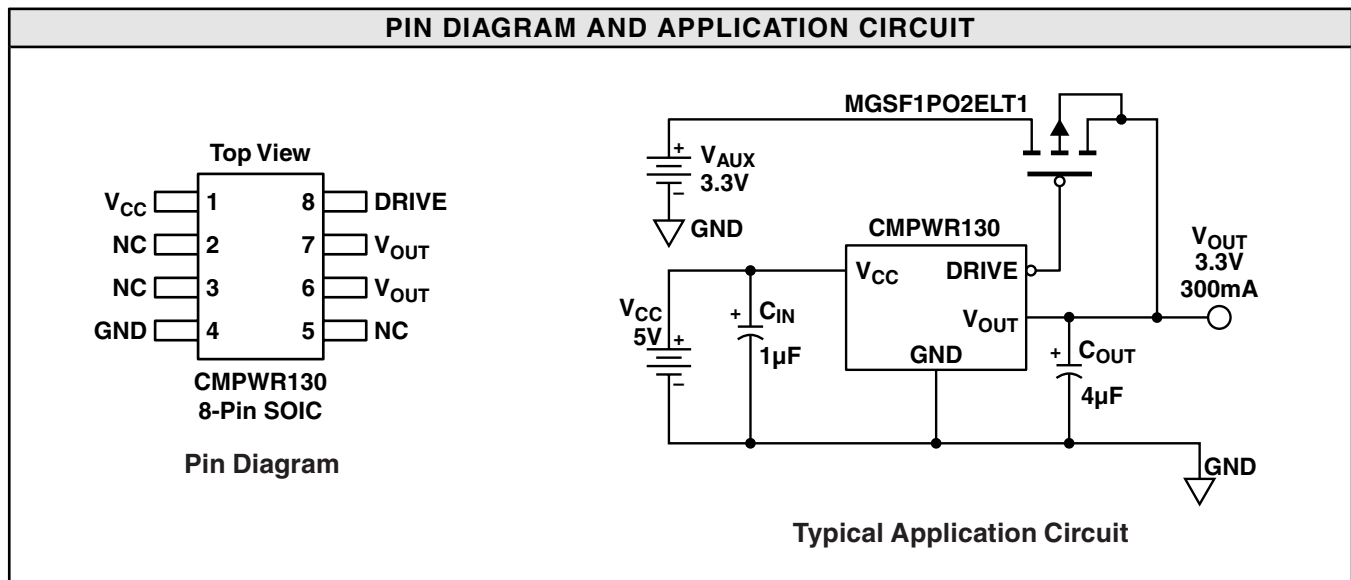

STANDARD PART ORDERING INFORMATION

Package		Ordering Part Number		
Pins	Style	Tubes	Tape & Reel	Part Marking
8	SOIC	CMPWR130S/T	CMPWR130S/R	CMPWR130S

ABSOLUTE MAXIMUM RATINGS		
Parameter	Rating	Unit
ESD Protection (HBM)	2000	V
V _{CC} , V _{OUT} Voltages	6.0, GND -0.5	V
Drive Logic Voltage	V _{CC} + 0.5, GND -0.5	V
Temperature: Storage	-40 to 150	°C
Operating Ambient	0 to 70	°C
Operating Junction	0 to 125	°C
Power Dissipation (Note 1)	0.6	W

OPERATING CONDITIONS		
Parameter	Range	Unit
V _{CC}	5 ± 0.5	V
Temperature (Ambient)	0 to 70	°C
Load Current	0 to 300	mA
C _{EXT}	4.7 ± 20%	µF

ELECTRICAL OPERATING CHARACTERISTICS (over operating conditions unless specified otherwise)						
Symbol	Parameter	Conditions	MIN	TYP	MAX	UNIT
V _{OUT}	Regulator Output Voltage	0mA < I _{LOAD} < 300mA	3.10	3.30	3.50	V
V _{CCSEL}	Select Voltage	Regulator Enabled		4.30	4.45	V
V _{CCDES}	Deselect Voltage	Regulator Disabled	3.90	4.10		V
V _{CHYST}	Hysteresis Voltage	Hysteresis (Note 2)		0.20		V
I _{S/C}	Short Circuit Output Current	V _{CC} = 5V, V _{OUT} = 0V	310			mA
I _{RCC}	V _{CC} Pin Reverse Leakage	V _{OUT} = 3.3V, V _{CC} = 0V		2	50	µA
V _{R LOAD}	Load Regulation	V _{CC} = 5V, I _{LOAD} = 30 to 300mA		50		mV
V _{R LINE}	Line Regulation	V _{CC} = 4.5V to 5.5V, I _{LOAD} = 5mA		50		mV
I _{CC}	Quiescent Supply Current	V _{CC} > V _{CCSEL} , I _{LOAD} = 0mA		0.6	0.8	mA
		V _{CCDES} > V _{CC} > V _{OUT}		0.2		mA
		V _{OUT} > V _{CC}		0.01	0.02	mA
I _{GND}	Ground Current (Note 3)	V _{CCSEL} > V _{CC} (Regulator Disabled)		0.2	0.4	mA
		V _{CC} = 5V, I _{LOAD} = 5mA		0.6	0.8	mA
		V _{CC} = 5V, I _{LOAD} = 300mA		0.7	1.4	mA
R _{OH}	Drive Pull-up Resistance	R _{PULLUP} to V _{CC} , V _{CC} > V _{CCSEL}		4.0	8.0	kΩ
R _{OL}	Drive Pull-down Resistance	R _{PULLDOWN} to GND, V _{CCDES} > V _{CC}		0.1	0.4	kΩ

Note 1: The power rating is based on a printed circuit board heat spreading capability equivalent to 2 square inches of copper connected to the GND pins. Typical multilayer boards using power plane construction will provide this heat spreading ability without the need for additional dedicated copper area. (Please consult with factory for thermal evaluation assistance.)

Note 2: The hysteresis defines the maximum level of acceptable disturbance on V_{CC} during switching. It is recommended that the V_{CC} source impedance be kept below 0.25Ω to ensure the switching disturbance remains below the hysteresis during select/deselect transitions. An input capacitor may be required to help minimize the switching transient.

Note 3: Ground pin current consists of controller current (0.15mA) and regulator current if enabled. The controller always draws 0.15mA from either V_{CC} or V_{OUT}, whichever is greater. All regulator current is supplied exclusively from V_{CC}. At high load currents a small increase occurs due to current limit protection circuitry.

Interface Signals

V_{CC} is the power source for the internal regulator and is monitored continuously by an internal controller circuit.

Whenever V_{CC} exceeds V_{CCSEL} (4.30V TYP), the internal regulator (300mA MAX) will be enabled and deliver a fixed 3.3V at V_{OUT} . When V_{CC} falls below V_{CCDES} (4.10V TYP) the regulator will be disabled.

Internal loading on this pin is typically 0.6mA when the regulator is enabled, which reduces to 0.2mA whenever the regulator is disabled. If V_{CC} falls below the voltage on the V_{OUT} pin the V_{CC} loading will further reduce to only a few microamperes.

During a V_{CC} power up sequence, there will be an effective step increase in V_{CC} line current when the regulator is enabled. The amplitude of this step increase will depend on the DC load current and any necessary current required for charging/discharging the load capacitance. This line current transient will cause a voltage disturbance at the V_{CC} pin. The magnitude of the disturbance will be directly proportional to the effective power supply source impedance being delivered to the V_{CC} input.

To prevent chatter during Select and Deselect transitions, a built-in hysteresis voltage of 200mV has been incorporated. It is recommended that the power supply connected to the V_{CC} input should have a source resistance of less than 0.25Ω to minimize the event of chatter during the enabling/disabling of the regulator.

An input filter capacitor in close proximity to the V_{CC} pin will reduce the effective source impedance and help minimize any disturbances. If the V_{CC} pin is within a few inches of the main input filter, a capacitor may not be

necessary. Otherwise an input filter capacitor in the range of $1\mu F$ to $10\mu F$ will ensure adequate filtering.

GND is the negative reference for all voltages. This current that flows in the ground connection is very low (TYP $550\mu A$) and has minimal variation over all load conditions.

V_{OUT} is the regulator output voltage connection used to power the load. An output capacitor of $4.7\mu F$ is used to provide the necessary phase compensation, thereby preventing oscillation. The capacitor also helps to minimize the peak output disturbance during power supply changeover.

When V_{CC} falls below V_{OUT} , then V_{OUT} will be used to provide the necessary quiescent current for the internal reference circuits. This ensures excellent start-up characteristics for the regulator.

DRIVE is an active LOW logic output intended to be used as the control signal for driving an external PFET whenever the regulator is disabled. This will allow the voltage at V_{OUT} to be powered from an auxiliary supply voltage (3.3V).

The Drive pin is pulled HIGH to V_{CC} whenever the regulator is enabled, this ensures the auxiliary remains isolated during normal regulator operation.

The output current sinking ability of this logic signal is equivalent to a 100Ω resistor. The current sourcing ability is equivalent to a $4k\Omega$ resistor.

NC pins are electrically isolated from the internal circuitry. These pins can be connected to any external voltage level without impacting the device functionality.

PIN FUNCTIONS		
Pin	Symbol	Description
1	V_{CC}	Positive (5V) supply input for regulator. ($V_{CC} > V_{CCSEL}$)
6, 7	V_{OUT}	Continuous output voltage (3.3V) is derived from either the internal regulator or low impedance switch connected to the auxiliary supply input.
8	DRIVE	Output drive signal to control external MOSFET switch
4	GND	Negative reference for all voltages
2, 3, 5	NC	Unconnected pin which is electrically isolated from internal circuitry.

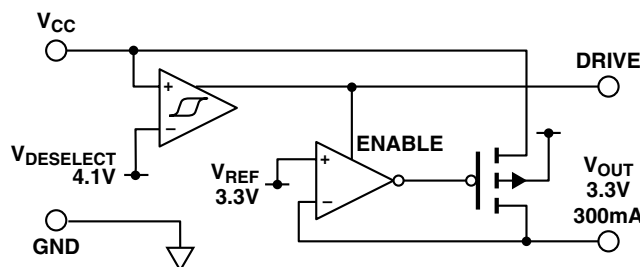

Simplified Electrical Schematic

Typical DC Characteristics (nominal conditions unless specified otherwise)

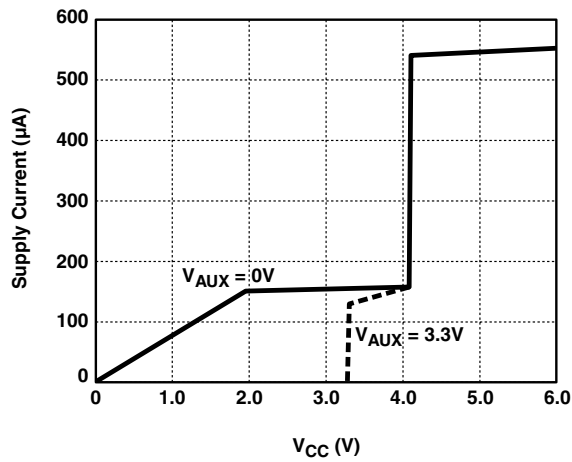

Figure 1. Supply Current vs Voltage ($V_{AUX} = 3.3V$)

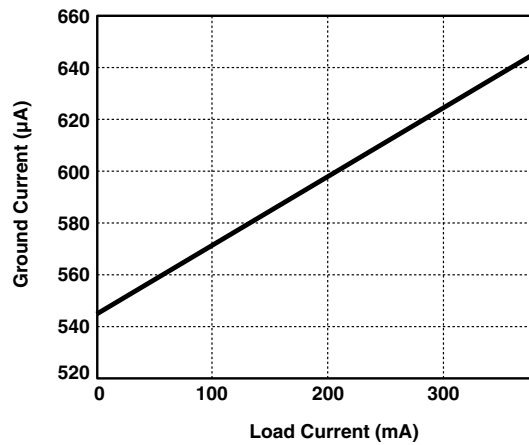

Figure 2. Ground Current vs Output Load

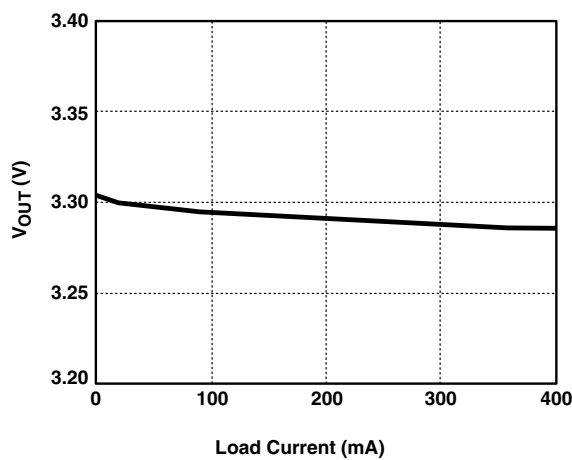

Figure 3. Load Regulation

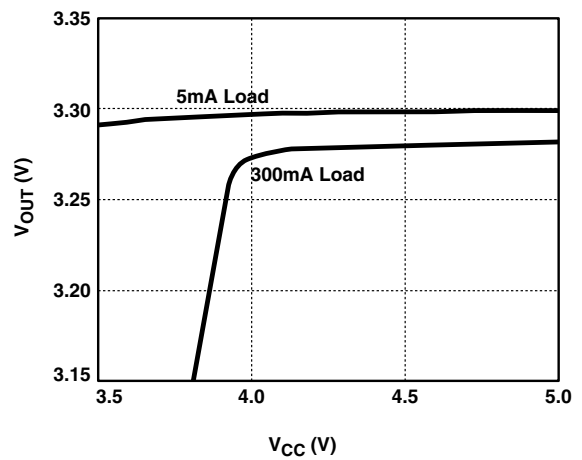

Figure 4. Line Regulation

Typical Transient Characteristics (Supply source resistance set to 0.2Ω)

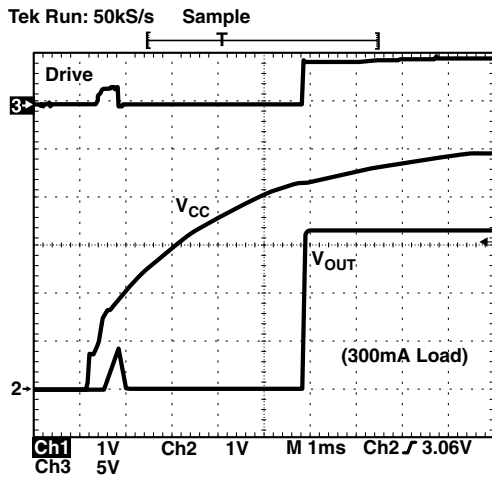

Figure 5. V_{CC} Cold Start Power UP ($V_{AUX} = 0V$)

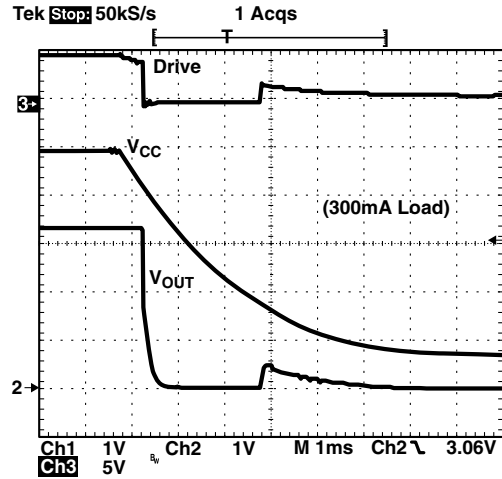

Figure 6. V_{CC} Complete Power Down ($V_{AUX} = 0V$)

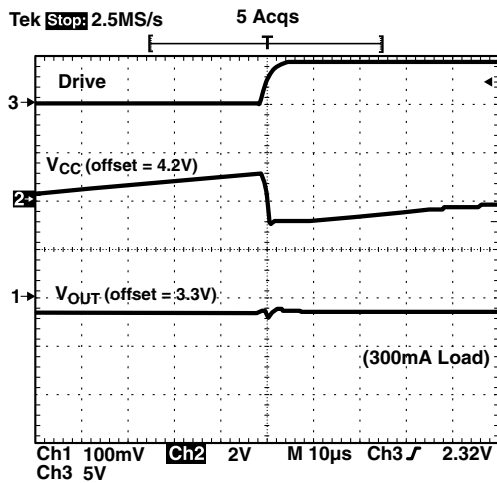

Figure 7. V_{CC} Power UP ($V_{AUX} = 3.3V$)

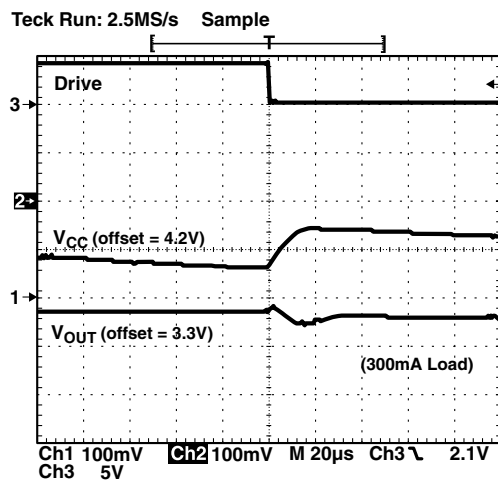

Figure 8. V_{CC} Power Down ($V_{AUX} = 3.3V$)

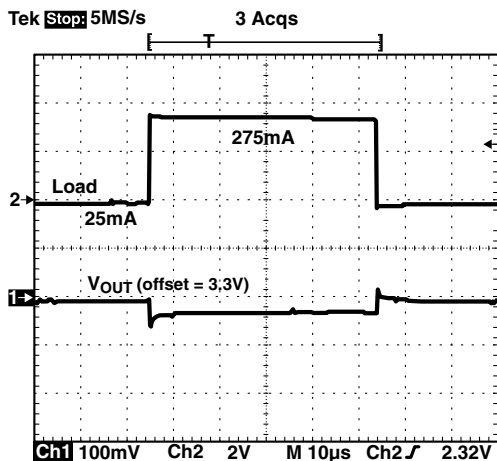

Figure 9. Load Transient (10% to 90%) Step Response

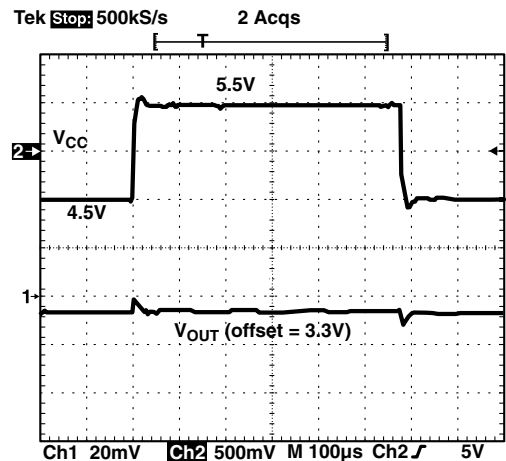

Figure 10. Line Transient ($1V_{pp}$) Step Response

Typical Thermal Characteristics

The overall junction to ambient thermal resistance (θ_{JA}) for device power dissipation (P_D) consists primarily of two paths in series. The first path is the junction to the case (θ_{JC}) which is defined by the package style, and the second path is case to ambient (θ_{CA}) thermal resistance which is dependent on board layout. The final operating junction temperature for any set of conditions can be estimated by the following thermal equation:

$$T_{JUNC} = T_{AMB} + P_D (\theta_{JC}) + P_D (\theta_{CA})$$

$$= T_{AMB} + P_D (\theta_{JA})$$

The CMPWR130 uses a standard SOIC package. When this package is mounted on a double sided printed circuit board with two square inches of copper allocated for "heat spreading", the resulting overall θ_{JA} is 85°C/W.

Based on maximum power dissipation of 0.51W (1.7V x 300mA) with an ambient of 70°C the resulting junction temperature will be:

$$T_{JUNC} = T_{AMB} + P_D (\theta_{JA})$$

$$= 70^\circ\text{C} + 0.51\text{W} (85^\circ\text{C/W})$$

$$= 70^\circ\text{C} + 43^\circ\text{C}$$

$$= 113^\circ\text{C}$$

Thermal characteristics were measured using a double sided board with two square inches of copper area connected to the GND pins for "heat spreading".

Measurements showing performance up to junction temperature of 125°C were performed under light load conditions (5mA). This allows the ambient temperature to be representative of the internal junction temperature.

Note: The use of multi-layer board construction with power planes will further enhance the thermal performance of the package. In the event of no copper area being dedicated for heat spreading, a multi-layer board construction, using only the minimum size pad layout, will typically provide the CMPWR130 with an overall θ_{JA} of 100°C/W, which allows up to 0.55W to be safely dissipated.

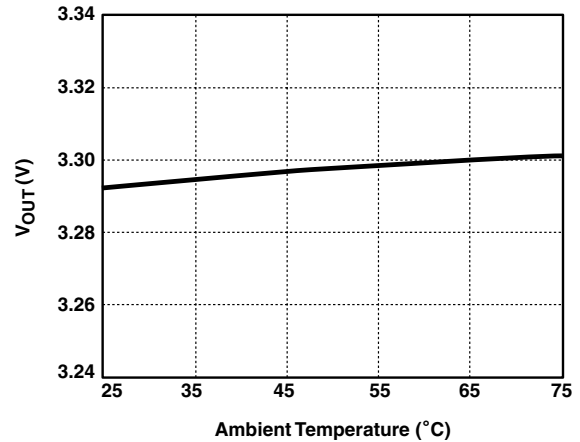

Figure 11. Regulator V_{OUT} vs T_{AMB} (300mA Load)

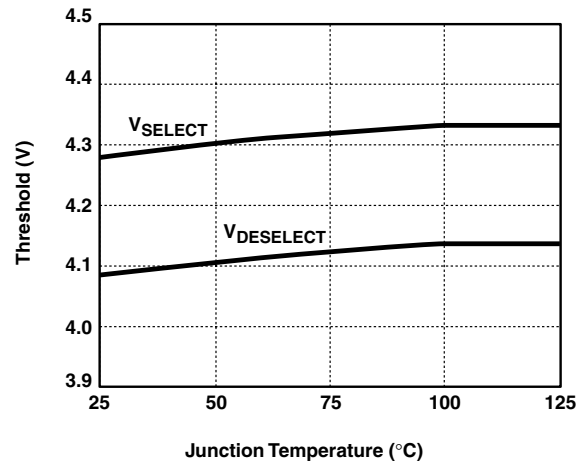

Figure 12. Select and Deselect Threshold vs T_{JUNC}