

# CMPWR150

## 500 mA/3.3 V SmartOR™ Power Regulator

### Product Description

The CMPWR150 is a low dropout regulator that delivers up to 500 mA of load current at a fixed 3.3 V output. An internal threshold level (typically 4.1 V) is used to prevent the regulator from being operated below dropout voltage. The device continuously monitors the input supply and will automatically disable the regulator when  $V_{CC}$  falls below the threshold level. When the regulator is disabled, the control signal “Drive” (Active Low) is enabled, which allows an external PMOS switch to power the load from an auxiliary 3.3 V supply.

When  $V_{CC}$  is restored to a level above the select threshold, the control signal for the external PMOS switch is disabled and the regulator is once again enabled.

All the necessary control circuitry needed to provide a smooth and automatic transition between the supplies has been incorporated. This allows  $V_{CC}$  to be dynamically switched without loss of output voltage.

The CMPWR150 is housed in an 8-pin SOIC thermally enhanced package which is ideal for space critical applications. The CMPWR150 is available with RoHS compliant lead-free finishing.

### Features

- Automatic Detection of  $V_{CC}$  Input Supply
- Drive Output Logic to Control External Switch
- Glitch-Free Output During Supply Transitions
- 500 mA Output Maximum Load Current
- Built-In Hysteresis During Supply Selection
- Controller Operates from Either  $V_{CC}$  or  $V_{OUT}$
- 8-Pin Power SOIC Thermal Package
- These Devices are Pb-Free and are RoHS Compliant

### Applications

- PCI Adapter Cards
- Network Interface Cards (NICs)
- Dual Power Systems
- Systems with Standby Capabilities
- USB Powered Devices Such as Printers, Scanners, MP3 Players and Zip Drives
- See Application Note AP-211



ON Semiconductor®

<http://onsemi.com>

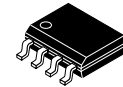

SOIC 8  
SF SUFFIX  
CASE 751BD

### MARKING DIAGRAM

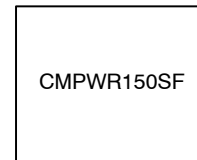

CMPWR150SF = Specific Device Code

### ORDERING INFORMATION

Device	Package	Shipping†
CMPWR150SF	SOIC (Pb-Free)	2500/Tape & Reel

†For information on tape and reel specifications, including part orientation and tape sizes, please refer to our Tape and Reel Packaging Specification Brochure, BRD8011/D.

# CMPWR150

## TYPICAL APPLICATION CIRCUIT

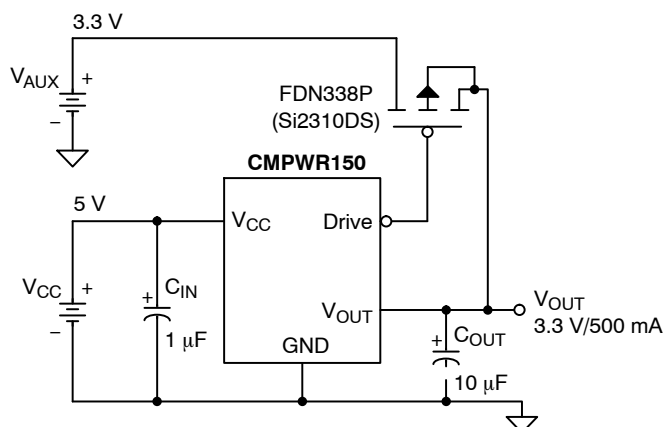

## SIMPLIFIED ELECTRICAL SCHEMATIC

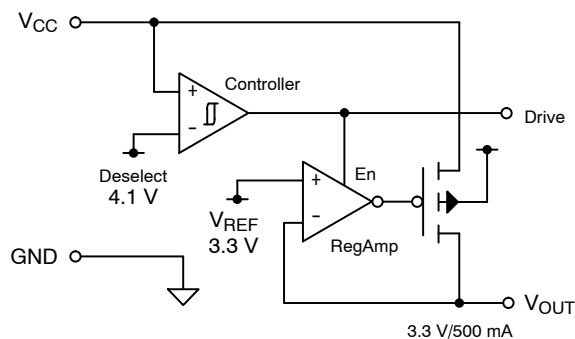

## PACKAGE / PINOUT DIAGRAM

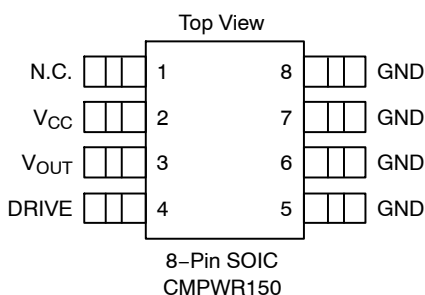

**Table 1. PIN DESCRIPTIONS**

Pin(s)	Name	Description
1	N.C.	This is a no-connect pin.
2	V <sub>CC</sub>	V <sub>CC</sub> is the power source for the internal regulator and is monitored continuously by an internal controller circuit. Whenever V <sub>CC</sub> exceeds V <sub>CCSEL</sub> (4.35 V typically), the internal regulator (500 mA max) will be enabled and deliver a fixed 3.3 V at V <sub>OUT</sub> . When V <sub>CC</sub> falls below V <sub>CCDES</sub> (4.10 V typically) the regulator will be disabled. Internal loading on this pin is typically 1.0 mA when the regulator is enabled, which decreases to 0.15 mA whenever the regulator is disabled. If V <sub>CC</sub> falls below the voltage on the V <sub>OUT</sub> pin the V <sub>CC</sub> loading will further decrease to only a few microamperes. During a V <sub>CC</sub> power up sequence, there will be an effective step increase in V <sub>CC</sub> line current when the regulator is enabled. The amplitude of this step increase will depend on the DC load current and any necessary current required for charging/discharging the load capacitance. This line current transient will cause a voltage disturbance at the V <sub>CC</sub> pin. The magnitude of the disturbance will be directly proportional to the effective power supply source impedance being delivered to the V <sub>CC</sub> input. To prevent chatter during Select and Deselect transitions, a built-in hysteresis voltage of 250 mV has been incorporated. It is recommended that the power supply connected to the V <sub>CC</sub> input have a source resistance of less than 0.25 Ω to minimize the event of chatter during the enabling/disabling of the regulator. An input filter capacitor in close proximity to the V <sub>CC</sub> pin will reduce the effective source impedance and help minimize any disturbances. If the V <sub>CC</sub> pin is within a few inches of the main input filter, a capacitor may not be necessary. Otherwise an input filter capacitor in the range of 1 µF to 10 µF will ensure adequate filtering.
3	V <sub>OUT</sub>	V <sub>OUT</sub> is the regulator output voltage connection used to power the load. An output capacitor of ten microfarads is used to provide the necessary phase compensation, thereby preventing oscillation. The capacitor also helps to minimize the peak output disturbance during power supply changeover. When V <sub>CC</sub> falls below V <sub>OUT</sub> , then V <sub>OUT</sub> will be used to provide the necessary quiescent current for the internal reference circuits. This ensures excellent start-up characteristics for the regulator.
4	DRIVE	DRIVE is an active LOW logic output intended to be used as the control signal for driving an external PFET whenever the regulator is disabled. This will allow the voltage at V <sub>OUT</sub> to be powered from an auxiliary supply voltage (3.3 V). The Drive pin is pulled HIGH to V <sub>CC</sub> whenever the regulator is enabled. This ensures that the auxiliary remains isolated during normal regulator operation.
5-8	GND	GND is the negative reference for all voltages. The current that flows in the ground connection is very low (typically 1.0 mA) and has minimal variation over all load conditions.

# CMPWR150

## SPECIFICATIONS

**Table 2. ABSOLUTE MAXIMUM RATINGS**

Parameter	Rating	Units
ESD Protection (HBM)	±2000	V
Pin Voltages V <sub>CC</sub> DRIVE	[GND - 0.5] to [+6.0] [GND - 0.5] to [V <sub>CC</sub> + 0.5]	V
Storage Temperature Range	-40 to +150	°C
Operating Temperature Range Ambient Junction	0 to +70 0 to +125	°C
Power Dissipation SOIC (Note 1)	1.0	W

Stresses exceeding Maximum Ratings may damage the device. Maximum Ratings are stress ratings only. Functional operation above the Recommended Operating Conditions is not implied. Extended exposure to stresses above the Recommended Operating Conditions may affect device reliability.

1. The SOIC package used is thermally enhanced through the use of a fused integral leadframe. The power rating is based on a printed circuit board heat spreading capability equivalent to 2 square inches of copper connected to the GND pins. Typical multi-layer boards using power plane construction will provide this heat spreading ability without the need for additional dedicated copper area. (Please consult factory for thermal evaluation assistance.)

**Table 3. STANDARD OPERATING CONDITIONS**

Parameter	Rating	Units
V <sub>CC</sub> Input Voltage	4.5 to 5.5	V
Ambient Operating Temperature Range	0 to +70	°C
Load Current	0 to 500	mA
C <sub>EXT</sub>	10 ±10%	µF

# CMPWR150

## SPECIFICATIONS (Cont'd)

**Table 4. ELECTRICAL OPERATING CHARACTERISTICS** (Note 2)

Symbol	Parameter	Conditions	Min	Typ	Max	Units
$V_{OUT}$	Regulator Output Voltage	$0\text{ mA} < I_{LOAD} < 500\text{ mA}$	3.135	3.300	3.465	V
$I_{OUT}$	Regulator Output Current		500	800		mA
$V_{CCSEL}$	Select Voltage	Regulator Enabled		4.35	4.45	V
$V_{CCDES}$	Deselect Voltage	Regulator Disabled	3.90	4.10		V
$V_{CCHYST}$	Hysteresis Voltage	Hysteresis (Note 3)		0.25		V
$I_{SC}$	Short-Circuit Output Current	$V_{CC} = 5\text{ V}, V_{OUT} = 0\text{ V}$		1200		mA
$I_{RCC}$	$V_{CC}$ Pin Reverse Leakage	$V_{OUT} = 3.3\text{ V}, V_{CC} = 0.0\text{ V}$		5	50	$\mu\text{A}$
$V_{R\text{ LOAD}}$	Load Regulation	$V_{CC} = 5\text{ V}, I_{LOAD} = 50\text{ to }500\text{ mA}$		75		mV
$V_{R\text{ LINE}}$	Line Regulation	$V_{CC} = 4.5\text{ to }5.5\text{ V}, I_{LOAD} = 5\text{ mA}$		2		mV
$I_{CC}$	Quiescent Supply Current	$V_{CC} > V_{CCDES}, I_{LOAD} = 0\text{ mA}$ $V_{CCDES} > V_{CC} > V_{OUT}$ $V_{OUT} > V_{CC}$		1.0 0.15 0.01	3.0 0.25 0.02	mA
$I_{GND}$	Ground Pin Current	Regulator Disabled (Note 4) $V_{CC} = 5\text{ V}, I_{LOAD} = 5\text{ mA}$ (Note 4) $V_{CC} = 5\text{ V}, I_{LOAD} = 500\text{ mA}$ (Note 4)		0.15 1.0 1.2	0.30 2.5 3.0	mA
$R_{OH}$	DRIVE Pull-up Resistance	$R_{PULLUP}$ to $V_{CC}$ , $V_{CC} > V_{CCSEL}$		100	400	$\Omega$
$R_{OL}$	DRIVE Pull-down Resistance	$R_{PULLDOWN}$ to GND, $V_{CCDES} > V_{CC}$		200	400	$\Omega$
$T_{DH}$	Drive High Delay	$C_{DRIVE} = 1\text{ nF}, V_{CC} T_{RISE} < 100\text{ ns}$		1.0		$\mu\text{S}$
$T_{DL}$	Drive Low Delay	$C_{DRIVE} = 1\text{ nF}, V_{CC} T_{FALL} < 100\text{ ns}$		0.2		$\mu\text{S}$

2. Operating Characteristics are over Standard Operating Conditions unless otherwise specified.

3. The hysteresis defines the maximum level of acceptable disturbance on  $V_{CC}$  during switching. It is recommended that the  $V_{CC}$  source impedance be kept below  $0.25\ \Omega$  to ensure the switching disturbance remains below the hysteresis during select/deselect transitions. An input capacitor may be required to help minimize the switching transient.

4. Ground pin current consists of controller current (0.15 mA) and regulator current if enabled. The controller always draws 0.15 mA from either  $V_{CC}$  or  $V_{OUT}$ , whichever is greater. All regulator current is supplied exclusively from  $V_{CC}$ . At high load currents a small increase occurs due to current limit protection circuitry.

TYPICAL DC CHARACTERISTICS

Unless stated otherwise, all DC characteristics were measured at room temperature with a nominal  $V_{CC}$  supply voltage of 5.0 V and an output capacitance of 10  $\mu$ F. The external PMOS switch was present and resistive load conditions were used.

The test data shown here was obtained from engineering samples. The device was modified to allow the regulator to function below the dropout threshold for the purpose of obtaining test data. During normal operation, production parts will shutdown the regulator below a 4.1 V supply.

**Dropout Characteristics** of the regulator are shown in Dropout Characteristics. At maximum rated load conditions (500 mA), a 100 mV drop in regulation occurs when the line voltage collapses below 4.1 V. For light load conditions (50 mA), regulation is maintained for line voltages as low as 3.5 V

In normal operation, the regulator is deselected at 4.1 V, which ensures a regulation output droop of less than 100 mV is maintained.

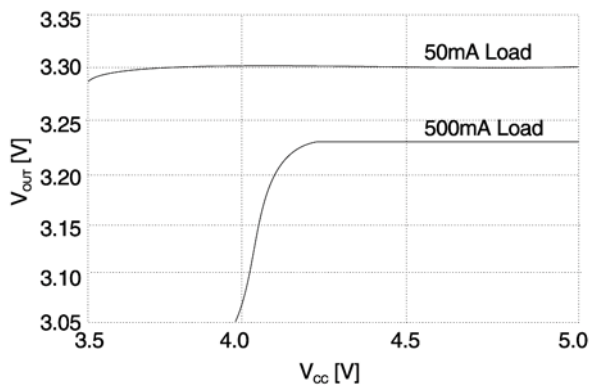

Figure 1. Dropout Characteristics

**Load Regulation** performance is shown from zero to maximum rated load in Load Regulation. A change in load from 10% to 100% of rated, results in an output voltage change of less than 75 mV. This translates into an effective output impedance of approximately 0.15  $\Omega$ .

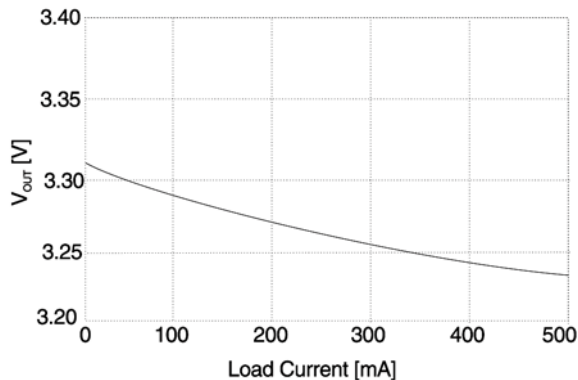

Figure 2. Load Regulation

**Ground Current** is shown across the entire range of load conditions in Ground Current. The ground current has minimal variation across the range of load conditions and shows only a slight increase at maximum load. This slight increase at rated load is due to the current limit protection circuitry becoming active.

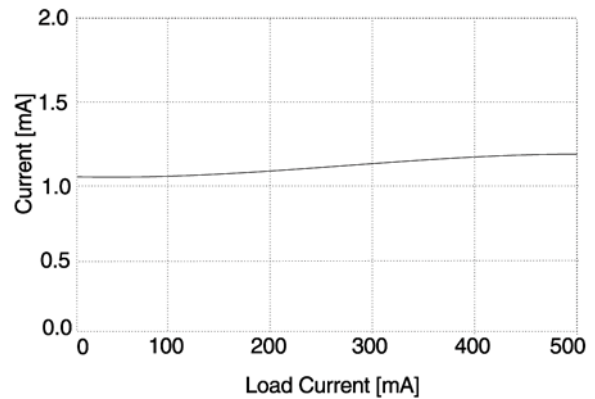

Figure 3. Ground Current

**$V_{CC}$  Supply Current** of the device is shown across the entire  $V_{CC}$  range for both  $V_{AUX}$  present (3.3 V) and absent (0 V) in V

In the absence of  $V_{AUX}$ , the supply current remains fixed at approximately 0.15 mA until  $V_{CC}$  reaches the Select voltage threshold of 4.35 V. At this point the regulator is enabled and a supply current of 1.0 mA is conducted.

When  $V_{AUX}$  is present, the  $V_{CC}$  supply current is less than 10 mA until  $V_{CC}$  exceeds  $V_{AUX}$ , at which point  $V_{CC}$  then powers the controller (0.15 mA). When  $V_{CC}$  reaches  $V_{SELECT}$ , the regulator is enabled.

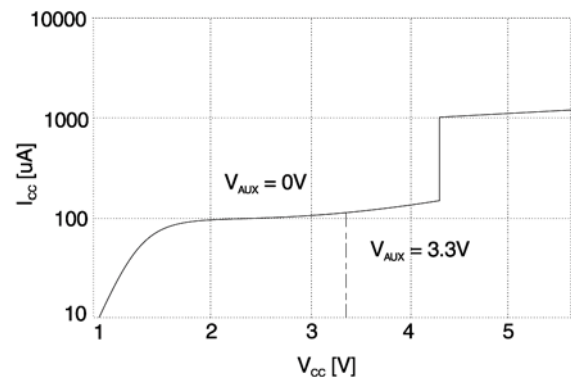

Figure 4.  $V_{CC}$  Supply Current (No Load)

TYPICAL TRANSIENT CHARACTERISTICS

The transient characterization test set-up shown below includes the effective source impedance of the  $V_{CC}$  supply ( $R_S$ ). This was measured to be approximately  $0.2 \Omega$ . It is recommended that this effective source impedance be no greater than  $0.25 \Omega$  to ensure precise switching is maintained during  $V_{CC}$  selection and deselection.

Both the rise and fall times during  $V_{CC}$  power-up/down sequencing were controlled at a 20 millisecond duration. This is considered to represent worst case conditions for most application circuits.

A maximum rated load current of 500 mA was used during characterization, unless specified otherwise.

During a selection or deselection transition, the DC load current is switching from  $V_{AUX}$  to  $V_{CC}$  and vice versa. In addition to the normal load current, there may also be an in-rush current for charging/discharging the load capacitor. The total current pulse being applied to either  $V_{AUX}$  or  $V_{CC}$  is equal to the sum of the DC load and the corresponding in-rush current. Transient currents in excess of 1.0 amps can readily occur for brief intervals when either supply commences to power the load.

The oscilloscope traces of  $V_{CC}$  power-up/down show the full bandwidth response at the  $V_{CC}$  and  $V_{OUT}$  pins under full load (500 mA) conditions.

See Application Note AP-211 for more information.

**$V_{CC}$  Power-up Cold Start.** Figure 5 shows the output response during an initial  $V_{CC}$  power-up with  $V_{AUX}$  not

present. When  $V_{CC}$  reaches the select threshold, the regulator turns on. The uncharged output capacitor causes maximum in-rush current to flow, resulting in a large voltage disturbance at the  $V_{CC}$  pin of about 230 mV. The built-in hysteresis of 250 mV ensures the regulator remains enabled throughout the transient.

Prior to  $V_{CC}$  reaching an acceptable logic supply level (2 V), a disturbance on the Drive pin can be observed.

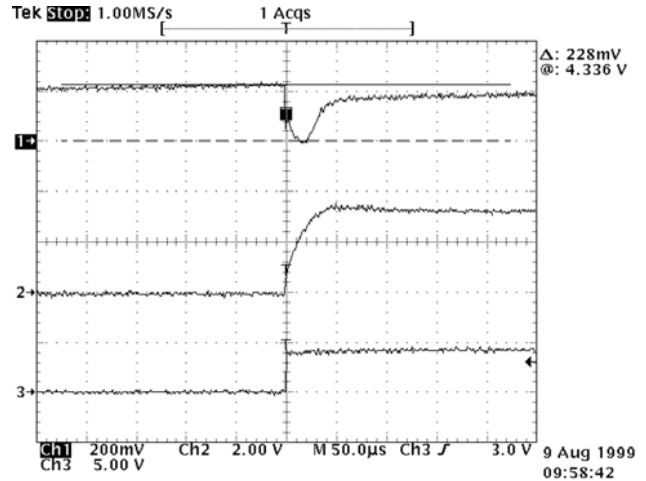

Figure 5.  $V_{CC}$  Power-up Cold Start

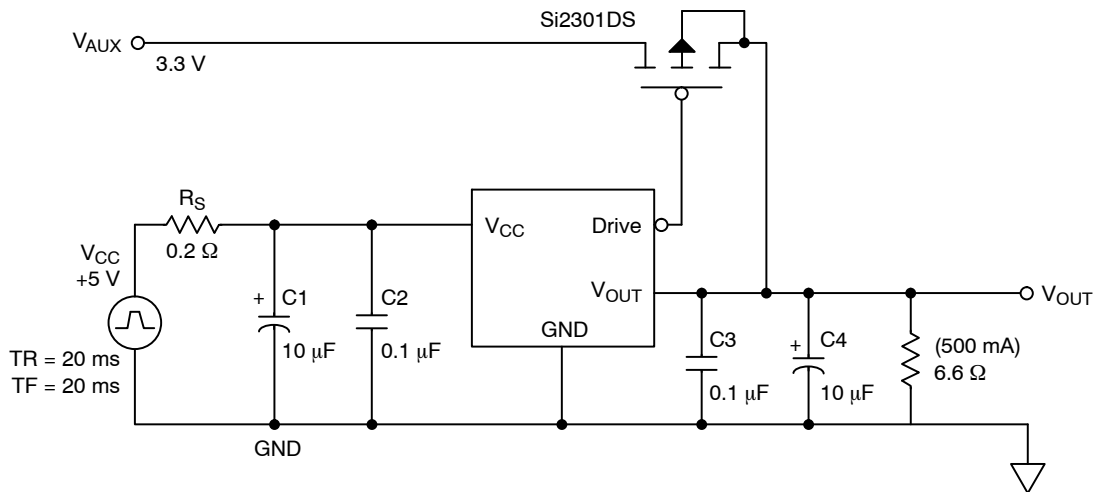

Figure 6. Transient Characteristics Test Set-Up

**V<sub>CC</sub> Power-up (V<sub>AUX</sub> = 3.3 V).** Figure 7 shows the output response as V<sub>CC</sub> approaches the select threshold during a power-up when V<sub>AUX</sub> is present (3.3 V). The output capacitor is already fully charged. When V<sub>CC</sub> reaches the select threshold, the in-rush current is minimal and the V<sub>CC</sub> disturbance is only 130 mV. The built-in hysteresis of 250 mV ensures the regulator remains enabled throughout the transient.

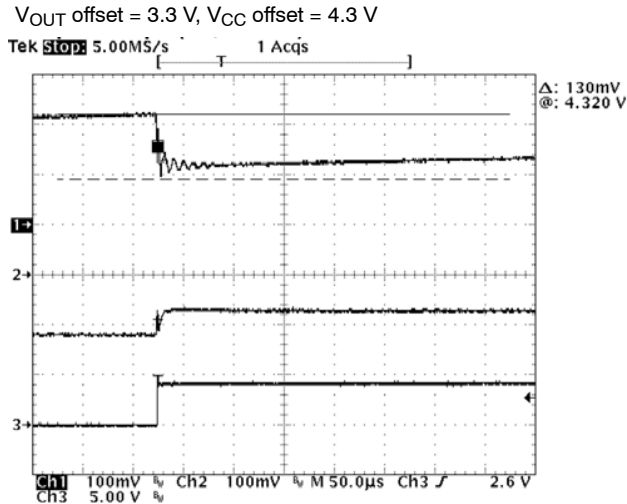

Figure 7. V<sub>CC</sub> Power-up (V<sub>AUX</sub> = 3.3 V)

**V<sub>CC</sub> Power-up (V<sub>AUX</sub> = 3.0 V).** Figure 8 shows the output response as V<sub>CC</sub> approaches the select threshold during power-up. The auxiliary voltage, V<sub>AUX</sub> is set to a low level of 3.0 V. When V<sub>CC</sub> reaches the select threshold, a modest level of in-rush current is required to further charge the output capacitor resulting in V<sub>CC</sub> disturbance of 200 mV. The built-in hysteresis of 250 mV ensures the regulator remains enabled throughout the transient.

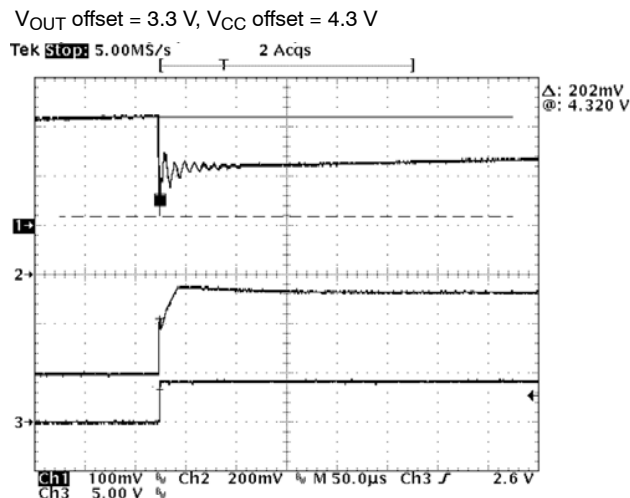

Figure 8. V<sub>CC</sub> Power-up (V<sub>AUX</sub> = 3.0 V)

**V<sub>CC</sub> Power-down (V<sub>AUX</sub> = 3.3V).** Figure 9 shows the output response as V<sub>CC</sub> approaches the deselect threshold

during a power-down transition. V<sub>AUX</sub> of 3.3 V remains present. When V<sub>CC</sub> reaches the deselect threshold (4.1 V), the regulator turns off. This causes a step change reduction in V<sub>CC</sub> current resulting in a small voltage increase at the V<sub>CC</sub> input. This disturbance is approximately 100 mV and the built-in hysteresis of 250 mV ensures the regulator remains disabled throughout the transient. The output voltage experiences a disturbance of approximately 100 mV during the transition.

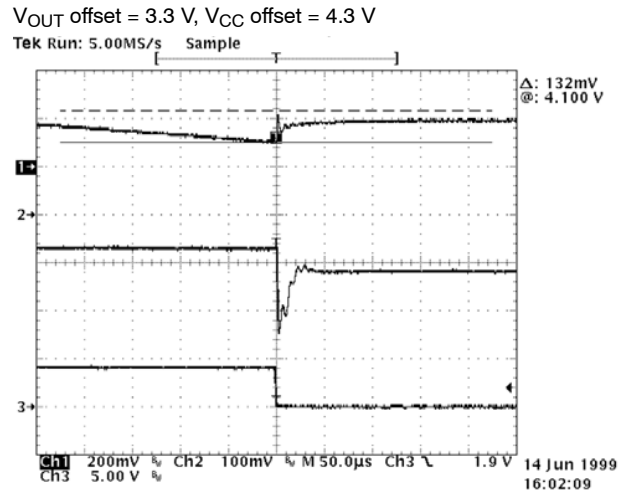

Figure 9. V<sub>CC</sub> Power-down (V<sub>AUX</sub> = 3.3 V)

**Load Step Response.** Figure 10 shows the output response of the regulator during a step load change from 5 mA to 500 mA (represented on Ch1). An initial transient overshoot of 50 mV occurs and the output settles to its final voltage within a few microseconds. The dc voltage disturbance on the output is approximately 75 mV, which demonstrates the regulator output impedance of 0.15 Ω.

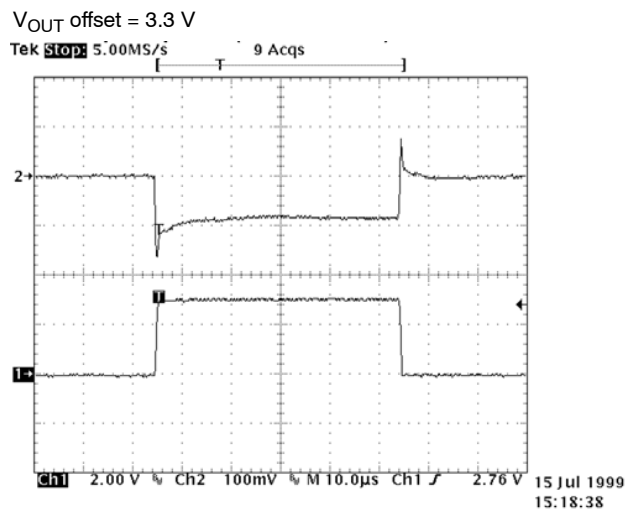

Figure 10. Load Step Response

**Line Step Response.** Figure 11 shows the output response of the regulator to a  $V_{CC}$  line voltage transient between 4.5 V and 5.5 V (1 V<sub>pp</sub> as shown on Ch1). The load condition during this test is 5 mA. The output response produces less than 10 mV of disturbance on both edges indicating a line rejection of better than 40 dB at high frequencies.

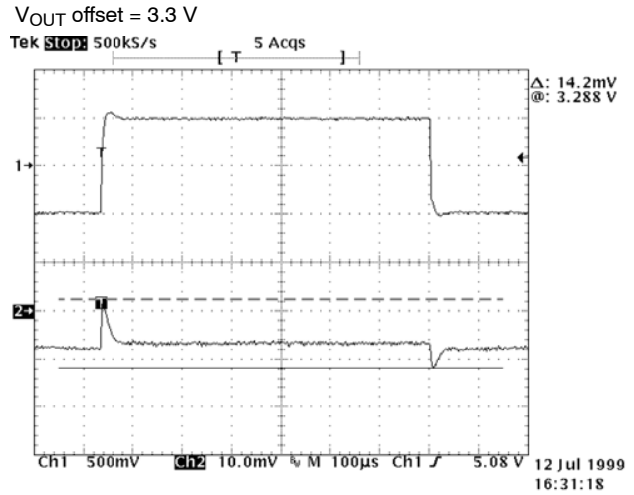

Figure 11. Line Step Response

**TYPICAL THERMAL CHARACTERISTICS**

Thermal dissipation of junction heat consists primarily of two paths in series. The first path is the junction to the case ( $\theta_{JC}$ ) thermal resistance, which is defined by the package style, and the second path is the case to ambient ( $\theta_{CA}$ ) thermal resistance, which is dependent on board layout.

For a given package style and board layout, the operating junction temperature is a function of junction power dissipation  $P_{JUNC}$  and the ambient temperature, resulting in the following thermal equation:

$$T_{JUNC} = T_{AMB} + T_{JUNC} (\theta_{JC}) + P_{JUNC} (\theta_{CA})$$

Measurements showing performance up to maximum junction temperature of 125°C were performed under light load conditions (5 mA). This allows the ambient temperature to be representative of the internal junction temperature.

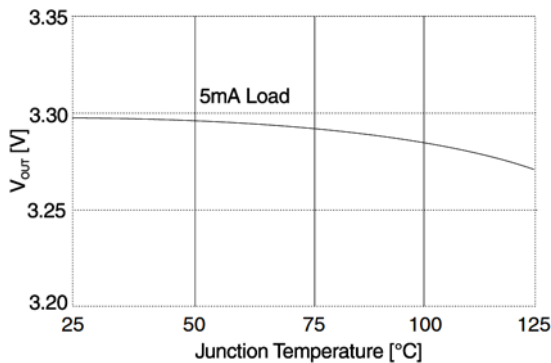

Figure 12. Output Voltage vs. Temperature

**Output Voltage vs. Temperature.** Figure 12 shows the regulator  $V_{OUT}$  performance up to the maximum rated junction temperature. The overall 100°C variation in junction temperature causes an output voltage change of about 30 mV, reflecting a voltage temperature coefficient of 90 ppm/°C.

**Output Voltage (500 mA) vs. Temperature.** Figure 13 shows the regulator steady state performance when fully loaded (500 mA) in an ambient temperature up to the rated maximum of 70°C. The output variation at maximum load is approximately 25 mV across the normal temperature range.

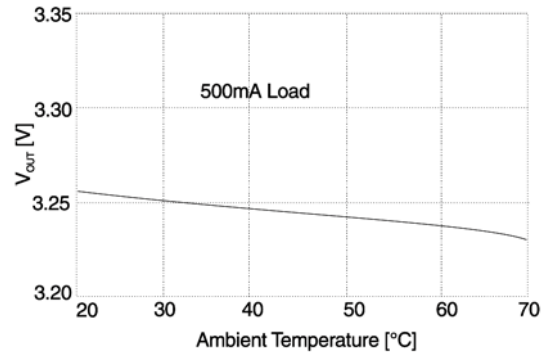
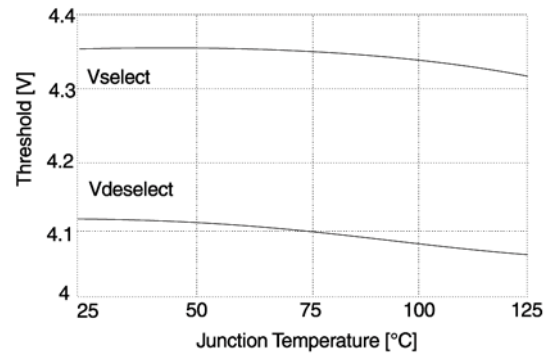

Figure 13. Output Voltage (500 mA) vs. Temperature



## CMPWR150

**Thresholds vs. Temperature.** Figure 14 shows the regulator select/deselect threshold variation up to the maximum rated junction temperature. The overall 100°C change in junction temperature causes a 30 mV variation in the select threshold voltage (regulator enable). The deselect threshold level varies about 50 mV over the 100°C change in junction temperature. This results in the built-in hysteresis having minimal variation over the entire operating junction temperature range.

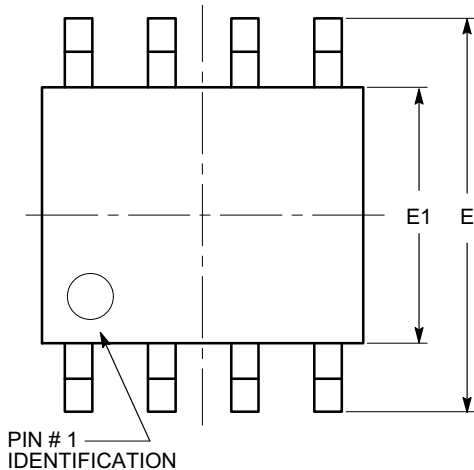

**Figure 14. Threshold vs. Temperature**

# CMPWR150

## PACKAGE DIMENSIONS

SOIC 8, 150 mils  
CASE 751BD-01  
ISSUE O



TOP VIEW

SYMBOL	MIN	NOM	MAX
A	1.35		1.75
A1	0.10		0.25
b	0.33		0.51
c	0.19		0.25
D	4.80		5.00
E	5.80		6.20
E1	3.80		4.00
e	1.27 BSC		
h	0.25		0.50
L	0.40		1.27
$\theta$	0°		8°

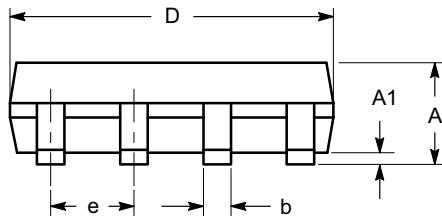

SIDE VIEW

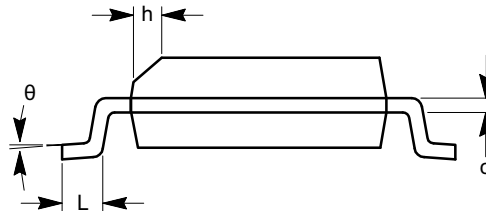

END VIEW

**Notes:**

- (1) All dimensions are in millimeters. Angles in degrees.
- (2) Complies with JEDEC MS-012.

SmartOR is a trademark of Semiconductor Components Industries, LLC (SCILLC).

**ON Semiconductor** and  are registered trademarks of Semiconductor Components Industries, LLC (SCILLC). SCILLC reserves the right to make changes without further notice to any products herein. SCILLC makes no warranty, representation or guarantee regarding the suitability of its products for any particular purpose, nor does SCILLC assume any liability arising out of the application or use of any product or circuit, and specifically disclaims any and all liability, including without limitation special, consequential or incidental damages. "Typical" parameters which may be provided in SCILLC data sheets and/or specifications can and do vary in different applications and actual performance may vary over time. All operating parameters, including "Typicals" must be validated for each customer application by customer's technical experts. SCILLC does not convey any license under its patent rights nor the rights of others. SCILLC products are not designed, intended, or authorized for use as components in systems intended for surgical implant into the body, or other applications intended to support or sustain life, or for any other application in which the failure of the SCILLC product could create a situation where personal injury or death may occur. Should Buyer purchase or use SCILLC products for any such unintended or unauthorized application, Buyer shall indemnify and hold SCILLC and its officers, employees, subsidiaries, affiliates, and distributors harmless against all claims, costs, damages, and expenses, and reasonable attorney fees arising out of, directly or indirectly, any claim of personal injury or death associated with such unintended or unauthorized use, even if such claim alleges that SCILLC was negligent regarding the design or manufacture of the part. SCILLC is an Equal Opportunity/Affirmative Action Employer. This literature is subject to all applicable copyright laws and is not for resale in any manner.

**PUBLICATION ORDERING INFORMATION**

**LITERATURE FULFILLMENT:**  
Literature Distribution Center for ON Semiconductor  
P.O. Box 5163, Denver, Colorado 80217 USA  
**Phone:** 303-675-2175 or 800-344-3860 Toll Free USA/Canada  
**Fax:** 303-675-2176 or 800-344-3867 Toll Free USA/Canada  
**Email:** orderlit@onsemi.com

**N. American Technical Support:** 800-282-9855 Toll Free USA/Canada  
**Europe, Middle East and Africa Technical Support:**  
Phone: 421 33 790 2910  
**Japan Customer Focus Center**  
Phone: 81-3-5773-3850

**ON Semiconductor Website:** [www.onsemi.com](http://www.onsemi.com)  
**Order Literature:** <http://www.onsemi.com/orderlit>  
For additional information, please contact your local Sales Representative