

GENERAL DESCRIPTION

This advanced high voltage MOSFET is designed to withstand high energy in the avalanche mode and switch efficiently. This new high energy device also offers a drain-to-source diode with fast recovery time. Designed for high voltage, high speed switching applications such as power supplies, converters, power motor controls and bridge circuits.

FEATURES

- ◆ Higher Current Rating
- ◆ Lower $R_{ds(on)}$
- ◆ Lower Capacitances
- ◆ Lower Total Gate Charge
- ◆ Tighter VSD Specifications
- ◆ Avalanche Energy Specified

PIN CONFIGURATION

TO-220/TO-220FP
Front View

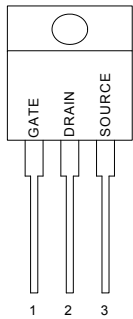

TO-252
Front View

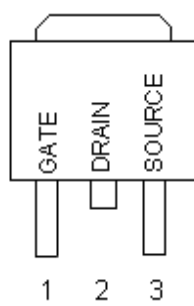

SYMBOL

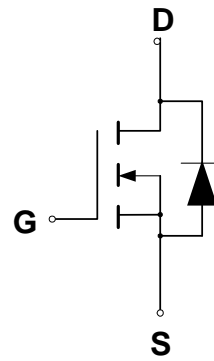

N-Channel MOSFET

ABSOLUTE MAXIMUM RATINGS

Rating	Symbol	Value	Unit
Drain to Current – Continuous	I_D	4.0	A
– Pulsed	I_{DM}	14	
Gate-to-Source Voltage – Continue	V_{GS}	± 30	V
– Non-repetitive	V_{GSM}	± 40	V
Total Power Dissipation	P_D		W
TO-220		83	
TO-220FP		30	
Operating and Storage Temperature Range	T_J, T_{STG}	-55 to 150	$^{\circ}C$
Single Pulse Drain-to-Source Avalanche Energy – $T_J = 25^{\circ}C$ ($V_{DD} = 100V, V_{GS} = 10V, I_L = 4A, L = 10mH, R_G = 25\Omega$)	E_{AS}	80	mJ
Thermal Resistance – Junction to Case	θ_{JC}	1.30	$^{\circ}C/W$
– Junction to Ambient	θ_{JA}	100	
Maximum Lead Temperature for Soldering Purposes, 1/8" from case for 10 seconds	T_L	260	$^{\circ}C$

ORDERING INFORMATION

Part Number	Package
CMT04N60GN220*	TO-220
CMT04N60XN220*	TO-220
CMT04N60GN220FP*	TO-220 Full Package
CMT04N60XN220FP*	TO-220 Full Package
CMT04N60GN252*	TO-252
CMT04N60XN252*	TO-252

*Note: G : Suffix for Pb Free Product

X : Suffix for Halogen and Pb Free Product

ELECTRICAL CHARACTERISTICS (Unless otherwise specified, T_J = 25°C.)

		CMT04N60			
Characteristic	Symbol	Min	Typ	Max	Units
Drain-Source Breakdown Voltage (V _{GS} = 0 V, I _D = 250 μA)	V _{(BR)DSS}	600			V
Drain-Source Leakage Current (V _{DS} = 600 V, V _{GS} = 0 V)	I _{DSS}			1	μA
Gate-Source Leakage Current-Forward (V _{gsf} = 30 V, V _{DS} = 0 V)	I _{GSSF}			100	nA
Gate-Source Leakage Current-Reverse (V _{gsr} = -30 V, V _{DS} = 0 V)	I _{GSSR}			100	nA
Gate Threshold Voltage (V _{DS} = V _{GS} , I _D = 250 μA)	V _{GS(th)}	2.0		4.0	V
Static Drain-Source On-Resistance (V _{GS} = 10 V, I _D = 2.0A) *	R _{DS(on)}			2.2	Ω
Forward Transconductance (V _{DS} = 50 V, I _D = 2.0 A) *	g _{FS}	2.5			mhos
Input Capacitance	C _{iSS} (V _{DS} = 25 V, V _{GS} = 0 V, f = 1.0 MHz)		540	760	pF
Output Capacitance		C _{oSS}	125	180	pF
Reverse Transfer Capacitance		C _{rSS}	8.0	20	pF
Turn-On Delay Time	t _{d(on)} (V _{DD} = 300 V, I _D = 4.0 A, V _{GS} = 10 V, R _G = 9.1Ω) *		12	20	ns
Rise Time		t _r	7.0	10	ns
Turn-Off Delay Time		t _{d(off)}	19	40	ns
Fall Time		t _f	10	20	ns
Total Gate Charge	Q _g (V _{DS} = 480 V, I _D = 4.0 A, V _{GS} = 10 V)*		5.0	10	nC
Gate-Source Charge		Q _{gs}	2.7		nC
Gate-Drain Charge		Q _{gd}	2.0		nC
Internal Drain Inductance (Measured from the drain lead 0.25" from package to center of die)	L _D		4.5		nH
Internal Drain Inductance (Measured from the source lead 0.25" from package to source bond pad)	L _S		7.5		nH
SOURCE-DRAIN DIODE CHARACTERISTICS					
Forward On-Voltage(1)	V _{SD} (I _S = 4.0 A, d _{IS} /d _t = 100A/μs)			1.5	V
Forward Turn-On Time		t _{on}	**		ns
Reverse Recovery Time		t _{rr}		655	

* Pulse Test: Pulse Width ≤ 300μs, Duty Cycle ≤ 2%

** Negligible, Dominated by circuit inductance

TYPICAL CHARACTERISTICS

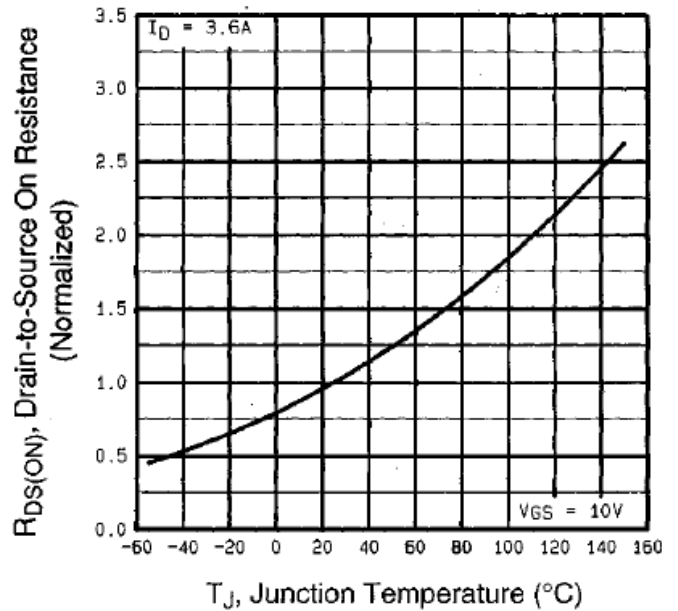
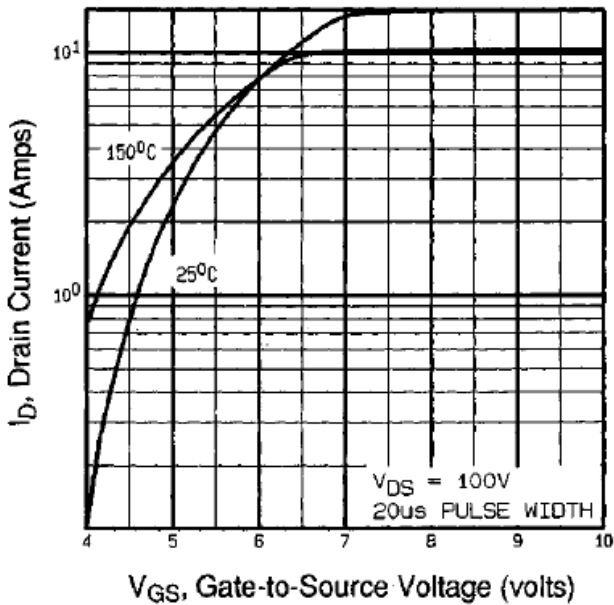
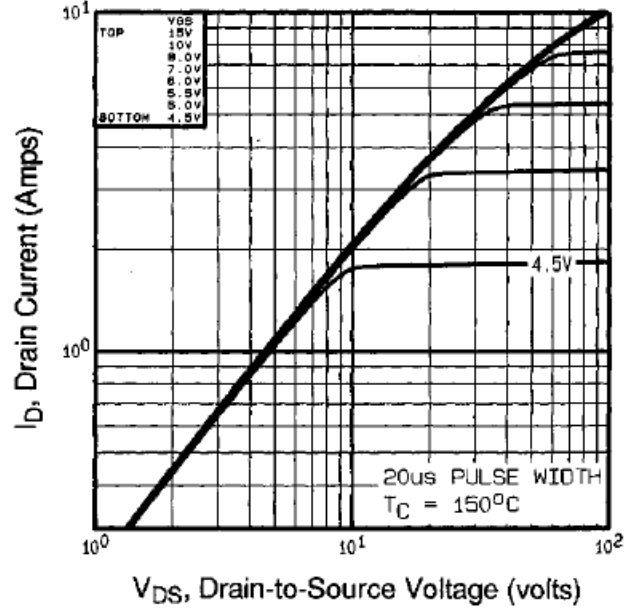
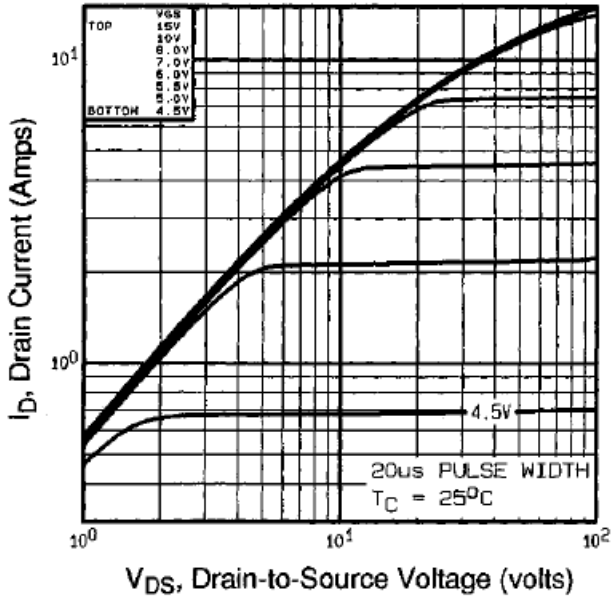

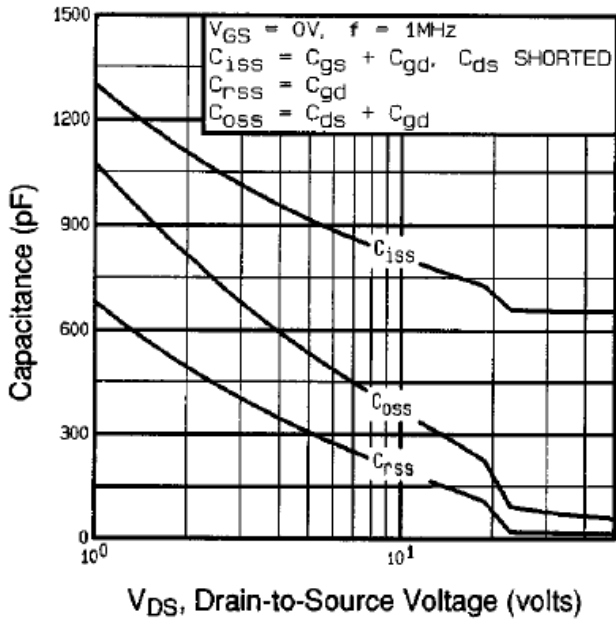

Fig 5. Typical Capacitance Vs. Drain-to-Source Voltage

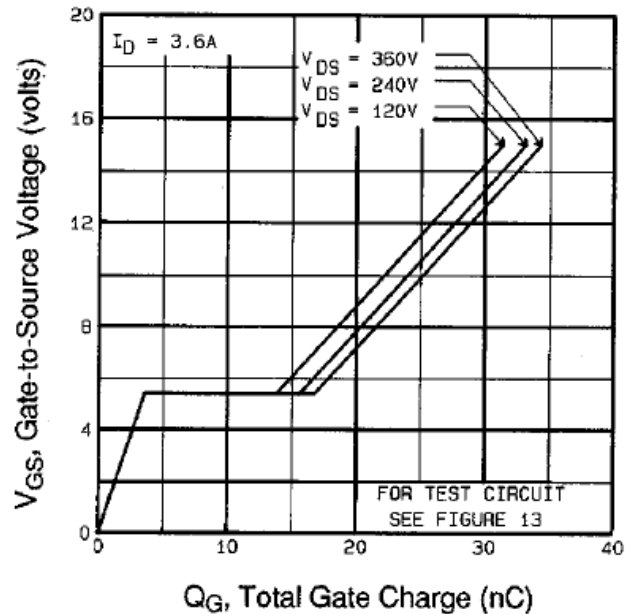

Fig 6. Typical Gate Charge Vs. Gate-to-Source Voltage

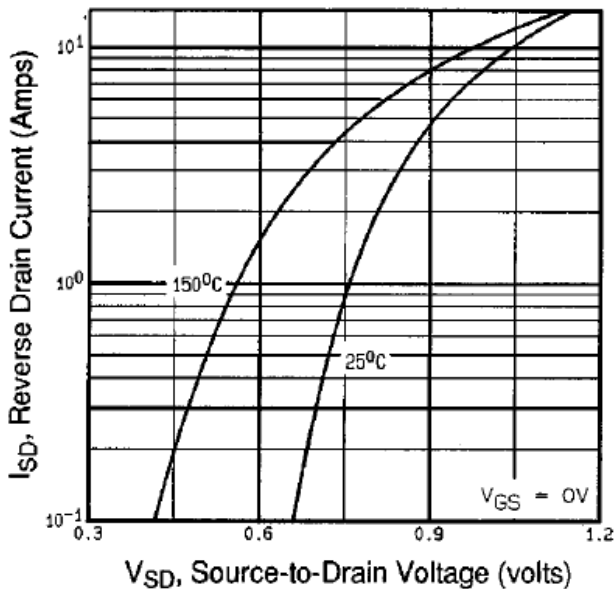

Fig 7. Typical Source-Drain Diode Forward Voltage

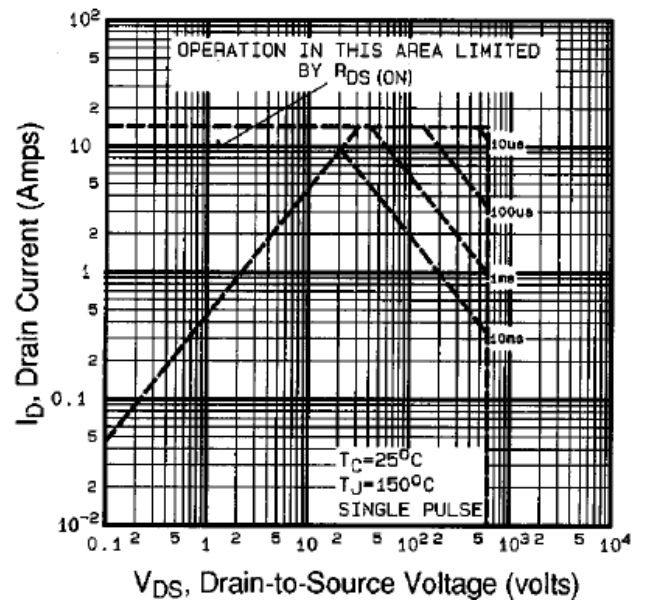
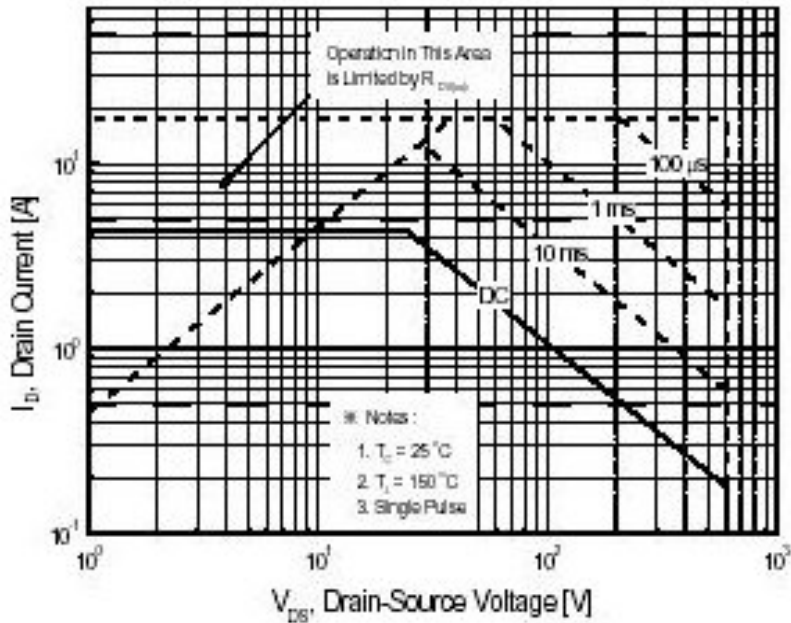
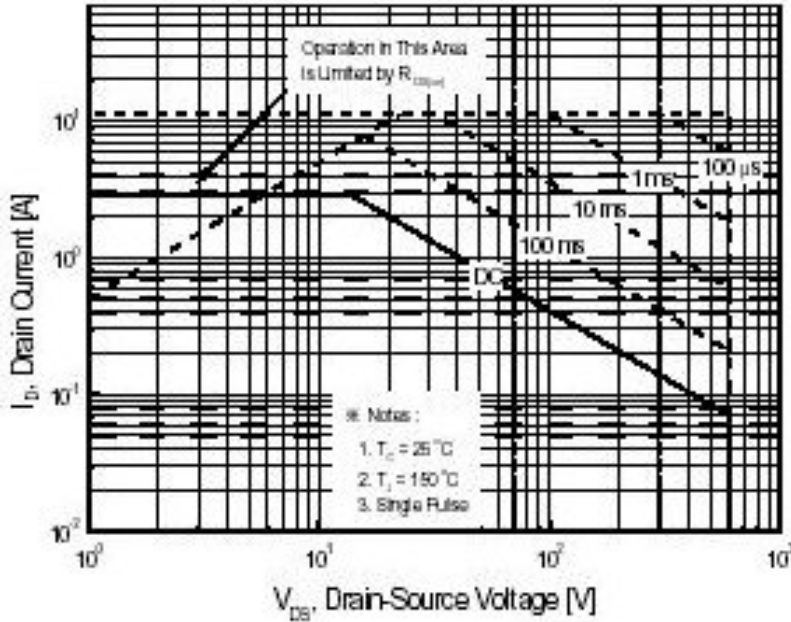

Fig 8. Maximum Safe Operating Area



Maximum Safe Operating Area

TO-220



Maximum Safe Operating Area

PACKAGE DIMENSION

TO-220

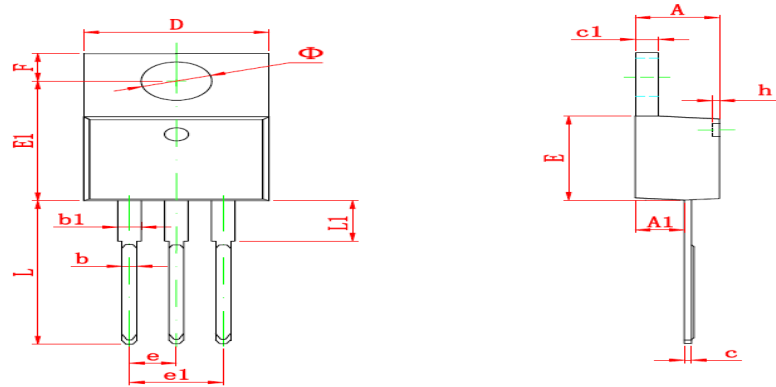

Symbol	Dimensions In Millimeters		Dimensions In Inches	
	Min	Max	Min	Max
A	4.470	4.670	0.176	0.184
A1	2.520	2.820	0.099	0.111
b	0.710	0.910	0.028	0.036
b1	1.170	1.370	0.046	0.054
c	0.310	0.530	0.012	0.021
c1	1.170	1.370	0.046	0.054
D	10.010	10.310	0.394	0.406
E	8.500	8.900	0.335	0.350
E1	12.060	12.460	0.475	0.491
e	2.540 TYP		0.100 TYP	
e1	4.980	5.180	0.196	0.204
F	2.590	2.890	0.102	0.114
h	0.000	0.300	0.000	0.012
L	13.400	13.800	0.528	0.543
L1	3.560	3.960	0.140	0.156
phi	3.735	3.935	0.147	0.155

TO-220FP

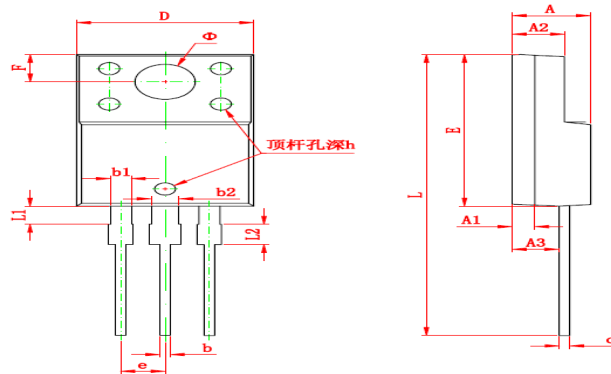

Symbol	Dimensions In Millimeters		Dimensions In Inches	
	Min	Max	Min	Max
A	4.300	4.700	0.169	0.185
A1	1.300 REF		0.051 REF	
A2	2.800	3.200	0.110	0.126
A3	2.500	2.900	0.098	0.114
b	0.500	0.750	0.020	0.030
b1	1.100	1.350	0.043	0.053
b2	1.500	1.750	0.059	0.069
c	0.500	0.750	0.020	0.030
D	9.960	10.360	0.392	0.408
E	14.800	15.200	0.583	0.598
e	2.540 TYP		0.100 TYP	
e1	2.700 REF		0.106 REF	
phi	3.500 REF		0.138 REF	
h	0.000	0.300	0.000	0.012
L	28.000	28.400	1.102	1.118
L1	1.700	1.900	0.067	0.075
L2	1.900	2.100	0.075	0.083

TO-252

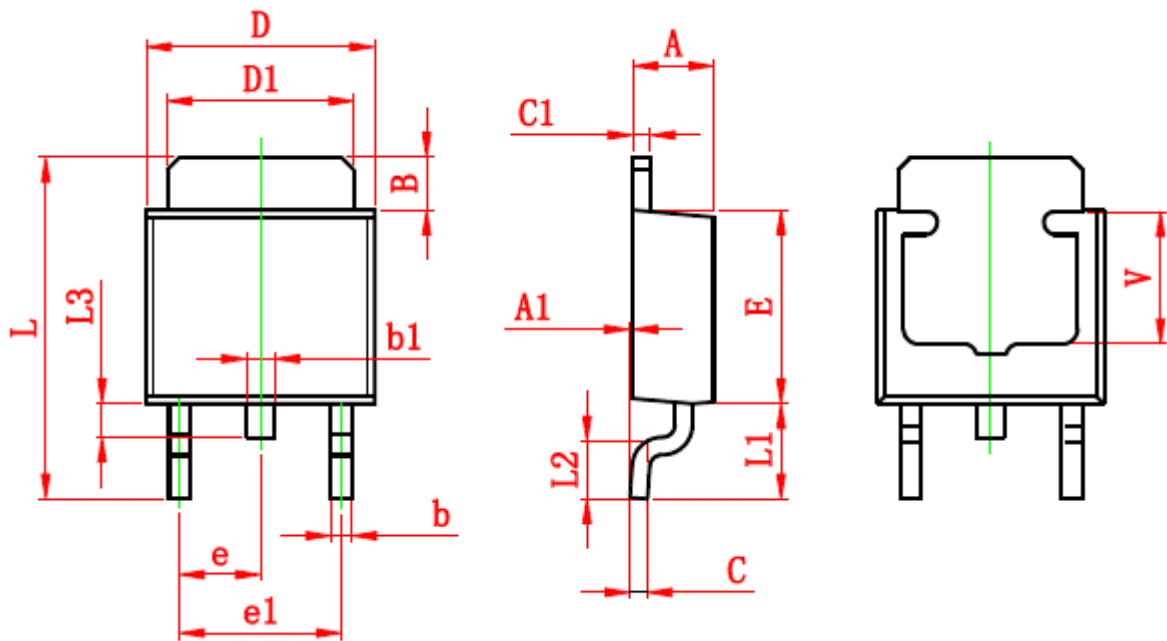

Symbol	Dimensions In Millimeters		Dimensions In Inches	
	Min.	Max.	Min.	Max.
A	2.200	2.400	0.087	0.094
A1	0.000	0.127	0.000	0.005
B	1.350	1.650	0.053	0.065
b	0.500	0.700	0.020	0.028
b1	0.700	0.900	0.028	0.035
c	0.430	0.580	0.017	0.023
c1	0.430	0.580	0.017	0.023
D	6.350	6.650	0.250	0.262
D1	5.200	5.400	0.205	0.213
E	5.400	5.700	0.213	0.224
e	2.300 TYP.		0.091 TYP.	
e1	4.500	4.700	0.177	0.185
L	9.500	9.900	0.374	0.390
L1	2.550	2.900	0.100	0.114
L2	1.400	1.780	0.055	0.070
L3	0.600	0.900	0.024	0.035
V	3.800 REF.		0.150 REF.	

IMPORTANT NOTICE

Champion Microelectronic Corporation (CMC) reserves the right to make changes to its products or to discontinue any integrated circuit product or service without notice, and advises its customers to obtain the latest version of relevant information to verify, before placing orders, that the information being relied on is current.

A few applications using integrated circuit products may involve potential risks of death, personal injury, or severe property or environmental damage. CMC integrated circuit products are not designed, intended, authorized, or warranted to be suitable for use in life-support applications, devices or systems or other critical applications. Use of CMC products in such applications is understood to be fully at the risk of the customer. In order to minimize risks associated with the customer's applications, the customer should provide adequate design and operating safeguards.

HsinChu Headquarter

5F, No. 11, Park Avenue II,
Science-Based Industrial Park,
HsinChu City, Taiwan
TEL: +886-3-567 9979
FAX: +886-3-567 9909

Sales & Marketing

21F., No. 96, Sec. 1, Sintai 5th Rd., Sijhih City,
Taipei County 22102,
Taiwan R.O.C
TEL: +886-2-2696 3558
FAX: +886-2-2696 3559
