

GENERAL DESCRIPTION

This high voltage MOSFET uses an advanced termination scheme to provide enhanced voltage-blocking capability without degrading performance over time. In addition, this advanced MOSFET is designed to withstand high energy in avalanche and commutation modes. The new energy efficient design also offers a drain-to-source diode with a fast recovery time. Designed for high voltage, high speed switching applications in power supplies, converters and PWM motor controls, these devices are particularly well suited for bridge circuits where diode speed and commutating safe operating areas are critical and offer additional and safety margin against unexpected voltage transients.

FEATURES

- ◆ Robust High Voltage Termination
- ◆ Avalanche Energy Specified
- ◆ Source-to-Drain Diode Recovery Time Comparable to a Discrete Fast Recovery Diode
- ◆ Diode is Characterized for Use in Bridge Circuits
- ◆ I_{DSS} Specified at Elevated Temperature

PIN CONFIGURATION

TO-220/TO-220FP
Front View

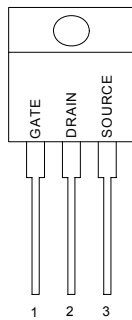

SYMBOL

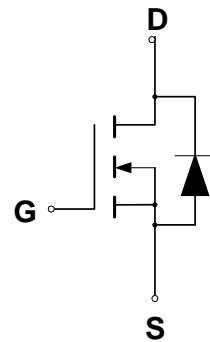

N-Channel MOSFET

ABSOLUTE MAXIMUM RATINGS

Rating	Symbol	Value	Unit
Drain to Current – Continuous	I_D	6.0	A
– Pulsed	I_{DM}	18	
Gate-to-Source Voltage – Continue	V_{GS}	± 20	V
– Non-repetitive	V_{GSM}	± 40	V
Total Power Dissipation	P_D		W
TO-220		125	
TO-220FP		45	
Operating and Storage Temperature Range	T_J, T_{STG}	-55 to 150	$^{\circ}C$
Single Pulse Drain-to-Source Avalanche Energy – $T_J = 25^{\circ}C$ ($V_{DD} = 100V, V_{GS} = 10V, I_L = 6A, L = 10mH, R_G = 25\Omega$)	E_{AS}	180	mJ
Thermal Resistance – Junction to Case	θ_{JC}	1.0	$^{\circ}C/W$
– Junction to Ambient	θ_{JA}	62.5	
Maximum Lead Temperature for Soldering Purposes, 1/8" from case for 10 seconds	T_L	260	$^{\circ}C$

- (1) $V_{DD} = 50V, I_D = 6A$
 (2) Pulse Width and frequency is limited by $T_{J(max)}$ and thermal response

ORDERING INFORMATION

Part Number	Package
CMT06N60N220	TO-220
CMT06N60N220FP	TO-220FP

TEST CIRCUIT

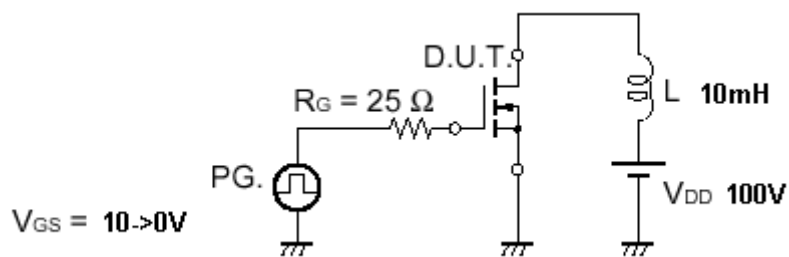

Test Circuit – Avalanche Capability

ELECTRICAL CHARACTERISTICS

Unless otherwise specified, $T_J = 25^\circ\text{C}$.

Characteristic	Symbol	CMT06N60			Units	
		Min	Typ	Max		
Drain-Source Breakdown Voltage ($V_{GS} = 0\text{ V}$, $I_D = 250\ \mu\text{A}$)	$V_{(BR)DSS}$	600			V	
Drain-Source Leakage Current ($V_{DS} = 600\text{ V}$, $V_{GS} = 0\text{ V}$) ($V_{DS} = 480\text{ V}$, $V_{GS} = 0\text{ V}$, $T_J = 125^\circ\text{C}$)	I_{DSS}			100 50	μA	
Gate-Source Leakage Current-Forward ($V_{gsf} = 20\text{ V}$, $V_{DS} = 0\text{ V}$)	I_{GSSF}			100	nA	
Gate-Source Leakage Current-Reverse ($V_{gsr} = 20\text{ V}$, $V_{DS} = 0\text{ V}$)	I_{GSSR}			100	nA	
Gate Threshold Voltage ($V_{DS} = V_{GS}$, $I_D = 250\ \mu\text{A}$)	$V_{GS(th)}$	2.0		4.0	V	
Static Drain-Source On-Resistance ($V_{GS} = 10\text{ V}$, $I_D = 3.5\text{A}$) *	$R_{DS(on)}$			1.2	Ω	
Forward Transconductance ($V_{DS} = 15\text{ V}$, $I_D = 3.0\text{A}$) *	g_{FS}	3.4			mhos	
Input Capacitance	$(V_{DS} = 25\text{ V}$, $V_{GS} = 0\text{ V}$, $f = 1.0\text{ MHz}$)	C_{iss}		1498	2100	pF
Output Capacitance		C_{oss}		158	220	pF
Reverse Transfer Capacitance		C_{rss}		29	60	pF
Turn-On Delay Time	$(V_{DD} = 300\text{ V}$, $I_D = 6.0\text{ A}$, $V_{GS} = 10\text{ V}$, $R_G = 9.1\Omega$) *	$t_{d(on)}$		14	30	ns
Rise Time		t_r		19	40	ns
Turn-Off Delay Time		$t_{d(off)}$		40	80	ns
Fall Time		t_f		26	55	ns
Total Gate Charge	$(V_{DS} = 300\text{ V}$, $I_D = 6.0\text{ A}$, $V_{GS} = 10\text{ V}$) *	Q_g		35.5	50	nC
Gate-Source Charge		Q_{gs}		8.1		nC
Gate-Drain Charge		Q_{gd}		14.1		nC
Internal Drain Inductance (Measured from the drain lead 0.25" from package to center of die)	L_D			4.5		nH
Internal Drain Inductance (Measured from the source lead 0.25" from package to source bond pad)	L_S			7.5		nH
SOURCE-DRAIN DIODE CHARACTERISTICS						
Forward On-Voltage(1)	$(I_S = 6.0\text{ A}$, $d_i/d_t = 100\text{A}/\mu\text{s}$)	V_{SD}		0.83	1.2	V
Forward Turn-On Time		t_{on}		**		ns
Reverse Recovery Time		t_{rr}		266		ns

* Pulse Test: Pulse Width $\leq 300\mu\text{s}$, Duty Cycle $\leq 2\%$

** Negligible, Dominated by circuit inductance

TYPICAL ELECTRICAL CHARACTERISTICS

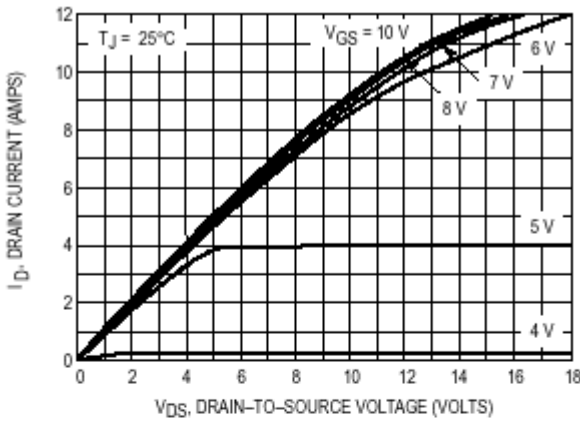

Figure 1. On-Region Characteristics

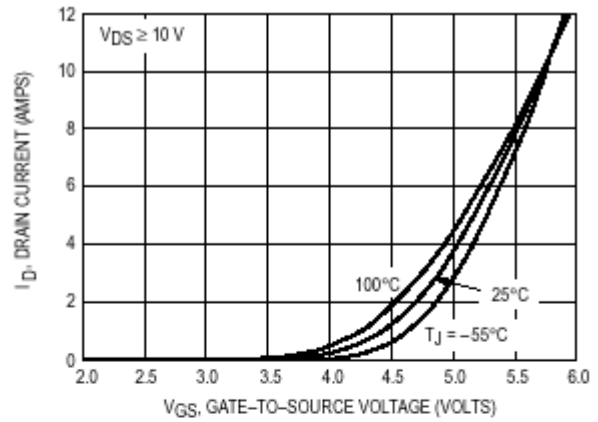

Figure 2. Transfer Characteristics

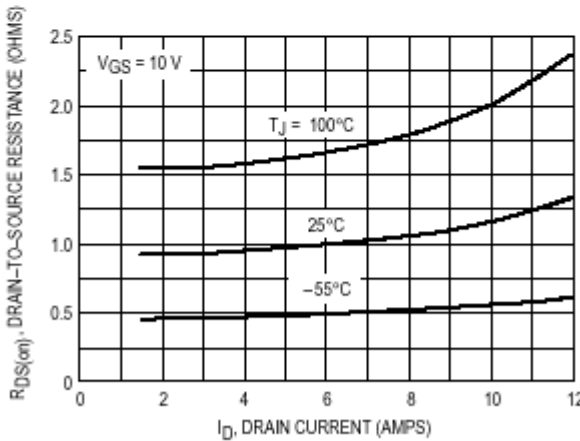

Figure 3. On-Resistance versus Drain Current and Temperature

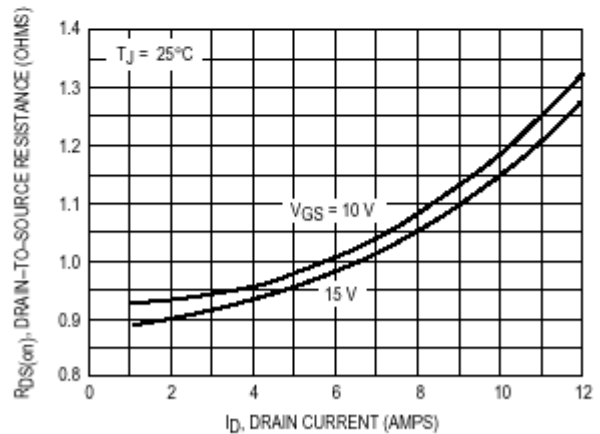

Figure 4. On-Resistance versus Drain Current and Gate Voltage

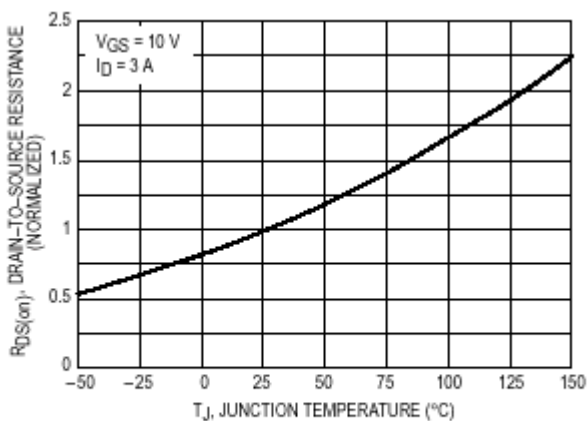

Figure 5. On-Resistance Variation with Temperature

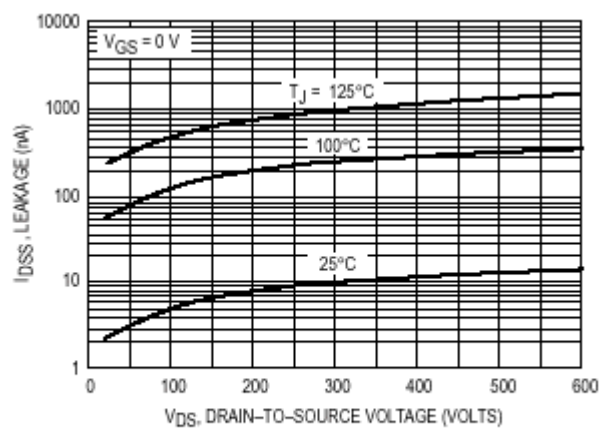
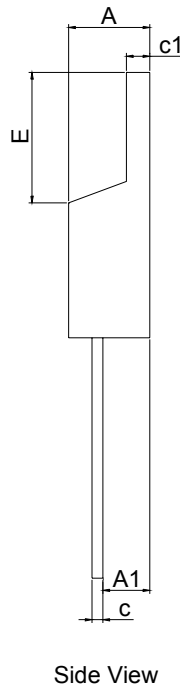
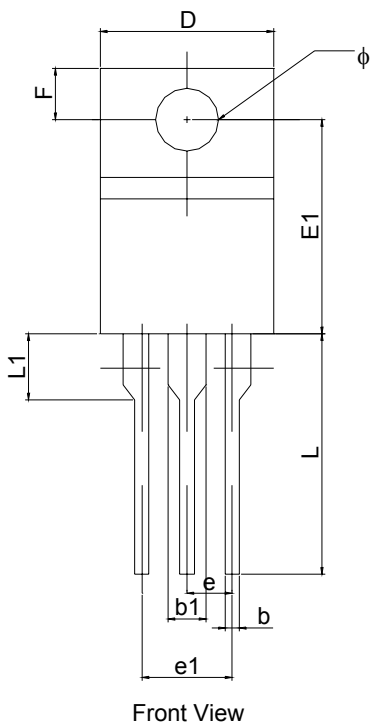

Figure 6. Drain-to-Source Leakage Current versus Voltage

PACKAGE DIMENSION

TO-220



PIN 1: GATE
PIN 2: DRAIN
PIN 3: SOURCE

SYMBOLS	DIMENSIONS IN MILLIMETERS			DIMENSIONS IN INCHES		
	MIN	NOM	MAX	MIN	NOM	MAX
A	4.47	---	4.67	0.176	---	0.184
A1	2.52	---	2.82	0.099	---	0.111
b	0.71	---	0.91	0.028	---	0.036
b1	1.17	---	1.37	0.046	---	0.054
c	0.31	---	0.53	0.012	---	0.021
c1	1.17	---	1.37	0.046	---	0.054
D	10.01	---	10.31	0.394	---	0.406
E	8.50	---	8.90	0.335	---	0.350
E1	12.06	---	12.46	0.475	---	0.491
e	---	2.54	---	---	0.100	---
e1	4.98	---	5.18	0.196	---	0.204
F	2.59	---	2.89	0.102	---	0.114
L	13.40	---	13.80	0.528	---	0.543
L1	3.56	---	3.96	0.140	---	0.156
φ	3.79	---	3.89	0.149	---	0.153

TO-220FP

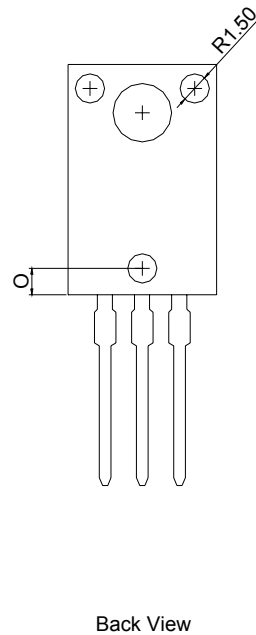
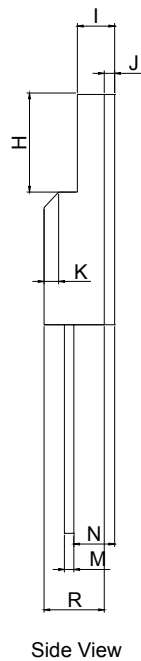
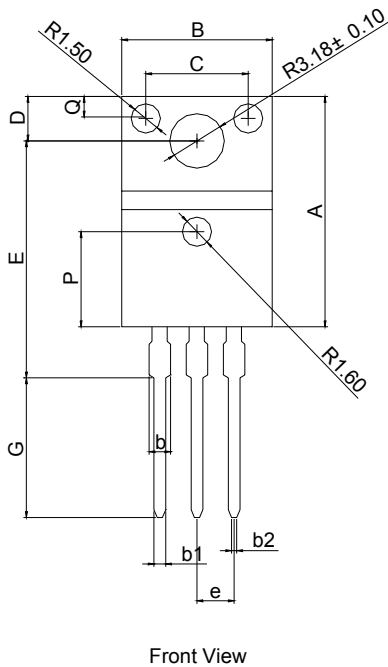

SYMBOLS	DIMENSIONS IN MILLIMETERS			DIMENSIONS IN INCHES		
	MIN	NOM	MAX	MIN	NOM	MAX
A	15.67	---	16.07	0.617	---	0.633
B	9.96	---	10.36	0.392	---	0.408
C	---	7.00	---	---	0.275	---
D	3.20	---	3.40	0.126	---	0.134
E	15.60	---	16.00	0.614	---	0.630
G	9.45	---	10.05	0.372	---	0.396
H	6.48	---	6.88	0.255	---	0.279
I	2.34	---	2.74	0.092	---	0.108
J	---	0.70	---	---	0.028	---
K	---	1.00	---	---	0.039	---
M	0.45	---	0.60	0.018	---	0.024
N	2.56	---	2.96	0.101	---	0.117
O	---	1.80	---	---	0.071	---
P	---	6.50	---	---	0.256	---
Q	---	1.50	---	---	0.059	---
R	4.50	---	4.90	0.177	---	0.193
b	---	---	1.47	---	---	0.058
b1	0.70	---	0.90	0.028	---	0.036
b2	0.25	---	0.45	0.010	---	0.018
e	---	2.54	---	---	0.100	---

IMPORTANT NOTICE

Champion Microelectronic Corporation (CMC) reserves the right to make changes to its products or to discontinue any integrated circuit product or service without notice, and advises its customers to obtain the latest version of relevant information to verify, before placing orders, that the information being relied on is current.

A few applications using integrated circuit products may involve potential risks of death, personal injury, or severe property or environmental damage. CMC integrated circuit products are not designed, intended, authorized, or warranted to be suitable for use in life-support applications, devices or systems or other critical applications. Use of CMC products in such applications is understood to be fully at the risk of the customer. In order to minimize risks associated with the customer's applications, the customer should provide adequate design and operating safeguards.

HsinChu Headquarter

5F, No. 11, Park Avenue II,
Science-Based Industrial Park,
HsinChu City, Taiwan
TEL: +886-3-567 9979
FAX: +886-3-567 9909

Sales & Marketing

7F-6, No.32, Sec. 1, Chenggong Rd., Nangang
District, Taipei City 115, Taiwan
TEL: +886-2-2788 0558
FAX: +886-2-2788 2985
