

Pioneer *sound.vision.soul*

COMPACT DISC PLAYER

CMX-3000

Operating Instructions

COMPACT
disc
DIGITAL AUDIO

COMPACT
disc
DIGITAL AUDIO
TEXT

Thank you for buying this Pioneer product. Please read through these operating instructions so you will know how to operate your model properly. After you have finished reading the instructions, put them away in a safe place for future reference. In some countries or regions, the shape of the power plug and power outlet may sometimes differ from that shown in the explanatory drawings. However the method of connecting and operating the unit is the same.

K015 En

CAUTION:
This product satisfies FCC regulations when shielded cables and connectors are used to connect the unit to other equipment. To prevent electromagnetic interference with electric appliances such as radios and televisions, use shielded cables and connectors for connections.

H012 En

IMPORTANT



The lightning flash with arrowhead symbol, within an equilateral triangle, is intended to alert the user to the presence of uninsulated "dangerous voltage" within the product's enclosure that may be of sufficient magnitude to constitute a risk of electric shock to persons.



CAUTION:
TO PREVENT THE RISK OF ELECTRIC SHOCK, DO NOT REMOVE COVER (OR BACK). NO USER-SERVICEABLE PARTS INSIDE. REFER SERVICING TO QUALIFIED SERVICE PERSONNEL.



The exclamation point within an equilateral triangle is intended to alert the user to the presence of important operating and maintenance (servicing) instructions in the literature accompanying the appliance.

IMPORTANT SAFETY INSTRUCTIONS

H003 En

READ INSTRUCTIONS — All the safety and operating instructions should be read before the product is operated.

RETAIN INSTRUCTIONS — The safety and operating instructions should be retained for future reference.

HEED WARNINGS — All warnings on the product and in the operating instructions should be adhered to.

FOLLOW INSTRUCTIONS — All operating and use instructions should be followed.

CLEANING — Unplug this product from the wall outlet before cleaning. The product should be cleaned only with a polishing cloth or a soft dry cloth. Never clean with furniture wax, benzene, insecticides or other volatile liquids since they may corrode the cabinet.

ATTACHMENTS — Do not use attachments not recommended by the product manufacturer as they may cause hazards.

WATER AND MOISTURE — Do not use this product near water — for example, near a bathtub, wash bowl, kitchen sink, or laundry tub; in a wet basement; or near a swimming pool; and the like.

ACCESSORIES — Do not place this product on an unstable cart, stand, tripod, bracket, or table. The product may fall, causing serious injury to a child or adult, and serious damage to the product. Use only with a cart, stand, tripod, bracket, or table recommended by the manufacturer, or sold with the product. Any mounting of the product should follow the manufacturer's instructions, and should use a mounting accessory recommended by the manufacturer.

CART — A product and cart combination should be moved with care. Quick stops, excessive force, and uneven surfaces may cause the product and cart combination to overturn.



VENTILATION — Slots and openings in the cabinet are provided for ventilation and to ensure reliable operation of the product and to protect it from overheating, and these openings must not be blocked or covered. The openings should never be blocked by placing the product on a bed, sofa, rug, or other similar surface. This product should not be placed in a built-in installation such as a bookcase or rack unless proper ventilation is provided or the manufacturer's instructions have been adhered to.

POWER SOURCES — This product should be operated only from the type of power source indicated on the marking label. If you are not sure of the type of power supply to your home, consult your product dealer or local power company.

LOCATION — The appliance should be installed in a stable location.

NONUSE PERIODS — The power cord of the appliance should be unplugged from the outlet when left unused for a long period of time.

GROUNDING OR POLARIZATION

- If this product is equipped with a polarized alternating current line plug (a plug having one blade wider than the other), it will fit into the outlet only one way. This is a safety feature. If you are unable to insert the plug fully into the outlet, try reversing the plug. If the plug should still fail to fit, contact your electrician to replace your obsolete outlet. Do not defeat the safety purpose of the polarized plug.

- If this product is equipped with a three-wire grounding type plug, a plug having a third (grounding) pin, it will only fit into a grounding type power outlet. This is a safety feature. If you are unable to insert the plug into the outlet, contact your electrician to replace your obsolete outlet. Do not defeat the safety purpose of the grounding type plug.

POWER-CORD PROTECTION — Power-supply cords should be routed so that they are not likely to be walked on or pinched by items placed upon or against them, paying particular attention to cords at plugs, convenience receptacles, and the point where they exit from the product.

OUTDOOR ANTENNA GROUNDING — If an outside antenna or cable system is connected to the product, be sure the antenna or cable system is grounded so as to provide some protection against voltage surges and built-up static charges. Article 810 of the National Electrical Code, ANSI/NFPA 70, provides information with regard to proper grounding of the mast and supporting structure, grounding of the lead-in wire to an antenna discharge unit, size of grounding conductors, location of antenna-discharge unit, connection to grounding electrodes, and requirements for the grounding electrode. See Figure A.

LIGHTNING — For added protection for this product during a lightning storm, or when it is left unattended and unused for long periods of time, unplug it from the wall outlet and disconnect the antenna or cable system. This will prevent damage to the product due to lightning and power-line surges.

POWER LINES — An outside antenna system should not be located in the vicinity of overhead power lines or other electric light or power circuits, or where it can fall into such power lines or circuits. When installing an outside antenna system, extreme care should be taken to keep from touching such power lines or circuits as contact with them might be fatal.

OVERLOADING — Do not overload wall outlets, extension cords, or integral convenience receptacles as this can result in a risk of fire or electric shock.

OBJECT AND LIQUID ENTRY — Never push objects of any kind into this product through openings as they may touch dangerous voltage points or short-out parts that could result in a fire or electric shock. Never spill liquid of any kind on the product.

SERVICING — Do not attempt to service this product yourself as opening or removing covers may expose you to dangerous voltage or other hazards. Refer all servicing to qualified service personnel.

DAMAGE REQUIRING SERVICE — Unplug this product from the wall outlet and refer servicing to qualified service personnel under the following conditions:

- When the power-supply cord or plug is damaged.
- If liquid has been spilled, or objects have fallen into the product.
- If the product has been exposed to rain or water.
- If the product does not operate normally by following the operating instructions. Adjust only those controls that are covered by the operating instructions as an improper adjustment of other controls may result in damage and will often require extensive work by a qualified technician to restore the product to its normal operation.
- If the product has been dropped or damaged in any way.
- When the product exhibits a distinct change in performance — this indicates a need for service.

REPLACEMENT PARTS — When replacement parts are required, be sure the service technician has used replacement parts specified by the manufacturer or have the same characteristics as the original part. Unauthorized substitutions may result in fire, electric shock, or other hazards.

SAFETY CHECK — Upon completion of any service or repairs to this product, ask the service technician to perform safety checks to determine that the product is in proper operating condition.

WALL OR CEILING MOUNTING — The product should not be mounted to a wall or ceiling.

HEAT — The product should be situated away from heat sources such as radiators, heat registers, stoves, or other products (including amplifiers) that produce heat.

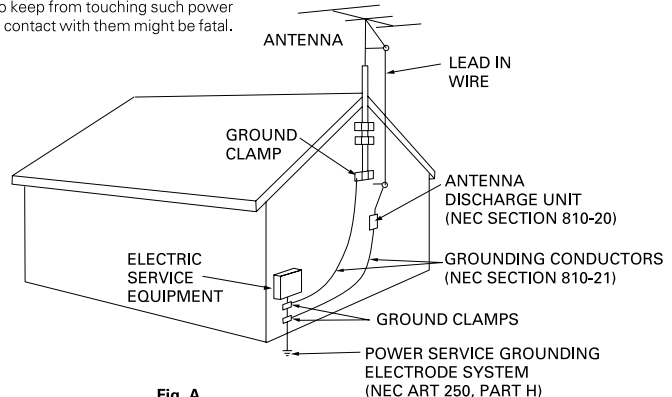

Fig. A

NEC — NATIONAL ELECTRICAL CODE

WARNING: THE APPARATUS IS NOT WATERPROOFS, TO PREVENT FIRE OR SHOCK HAZARD, DO NOT EXPOSE THIS APPLIANCE TO RAIN OR MOISTURE AND DO NOT PUT ANY WATER SOURCE NEAR THIS APPARATUS, SUCH AS VASE, FLOWER POT, COSMETICS CONTAINER AND MEDICINE BOTTLE ETC.

H001AEn

[For Canadian model]

CAUTION: TO PREVENT ELECTRIC SHOCK, DO NOT USE THIS (POLARIZED) PLUG WITH AN EXTENSION CORD, RECEPTACLE OR OTHER OUTLET UNLESS THE BLADES CAN BE FULLY INSERTED TO PREVENT BLADE EXPOSURE.

ATTENTION: POUR PREVENIR LES CHOCS ELECTRIQUES NE PAS UTILISER CETTE FICHE POLARISEE AVEC UN PROLONGATEUR UNE PRISE DE COURANT OU UNE AUTRE SORTIE DE COURANT, SAUF SI LES LAMES PEUVENT ETRE INSEREES A FOND SANS EN LAISSER AUCUNE PARTIE A DECOUVERT.

H007A2L

IMPORTANT NOTICE

The serial number for this equipment is located on the rear panel. Please write this serial number on your enclosed warranty card and keep it in a secure area. This is for your security.

[For Canadian model]

This Class B digital apparatus complies with Canadian ICES-003.

[Pour le modèle Canadien]

Cet appareil numérique de la classe B est conforme à la norme NMB-003 du Canada.

H009 2L

Information to User

Alteration or modifications carried out without appropriate authorization may invalidate the user's right to operate the equipment.

H011 En

NOTE: This equipment has been tested and found to comply with the limits for a Class B digital device, pursuant to Part 15 of the FCC Rules. These limits are designed to provide reasonable protection against harmful interference in a residential installation. This equipment generates, uses, and can radiate radio frequency energy and, if not installed and used in accordance with the instructions, may cause harmful interference to radio communications. However, there is no guarantee that interference will not occur in a particular installation. If this equipment does cause harmful interference to radio or television reception, which can be determined by turning the equipment off and on, the user is encouraged to try to correct the interference by one or more of the following measures:

- Reorient or relocate the receiving antenna.
- Increase the separation between the equipment and receiver.
- Connect the equipment into an outlet on a circuit different from that to which the receiver is connected.
- Consult the dealer or an experienced radio/TV technician for help.

H010 En

CAUTION : USE OF CONTROLS OR ADJUSTMENTS OR PERFORMANCE OF PROCEDURES OTHER THAN THOSE SPECIFIED HEREIN MAY RESULT IN HAZARDOUS RADIATION EXPOSURE.

CAUTION : THE USE OF OPTICAL INSTRUMENTS WITH THIS PRODUCT WILL INCREASE EYE HAZARD.

H013 En



Dear Customer:

Selecting fine audio equipment such as the unit you've just purchased is only the start of your musical enjoyment. Now it's time to consider how you can maximize the fun and excitement your equipment offers. This manufacturer and the Electronic Industries Association's Consumer Electronics Group want you to get the most out of your equipment by playing it at a safe level. One that lets the sound come through loud and clear without annoying blaring or distortion-and, most importantly, without affecting your sensitive hearing.

Sound can be deceiving. Over time your hearing "comfort level" adapts to higher volumes of sound. So what sounds "normal" can actually be loud and harmful to your hearing. Guard against this by setting your equipment at a safe level BEFORE your hearing adapts.

To establish a safe level:

- Start your volume control at a low setting.
- Slowly increase the sound until you can hear it comfortably and clearly, and without distortion.

Once you have established a comfortable sound level:

- Set the dial and leave it there.

Taking a minute to do this now will help to prevent hearing damage or loss in the future. After all, we want you listening for a lifetime.

We Want You Listening For A Lifetime

Used wisely, your new sound equipment will provide a lifetime of fun and enjoyment. Since hearing damage from loud noise is often undetectable until it is too late, this manufacturer and the Electronic Industries Association's Consumer Electronics Group recommend you avoid prolonged exposure to excessive noise. This list of sound levels is included for your protection.

Decibel

Level	Example
30	Quiet library, soft whispers
40	Living room, refrigerator, bedroom away from traffic
50	Light traffic, normal conversation, quiet office
60	Air conditioner at 20 feet, sewing machine
70	Vacuum cleaner, hair dryer, noisy restaurant
80	Average city traffic, garbage disposals, alarm clock at two feet.

THE FOLLOWING NOISES CAN BE DANGEROUS UNDER CONSTANT EXPOSURE

90	Subway, motorcycle, truck traffic, lawn mower
100	Garbage truck, chain saw, pneumatic drill
120	Rock band concert in front of speakers, thunderclap
140	Gunshot blast, jet plane
180	Rocket launching pad

Information courtesy of the Deafness Research Foundation.



CAUTIONS REGARDING HANDLING

Location

Install the player in a well-ventilated location where it will not be exposed to high temperatures or humidity.

Do not install the player in a location which is exposed to direct sunlight, or near stoves or radiators. Excessive heat can adversely affect the cabinet and internal components. Installation of the player in a damp or dusty environment may also result in a malfunction and can be hazardous. Avoid installation near cookers etc., where the player may be exposed to oily smoke, steam or heat.

Installation guidelines

- Placing and using the compact disc player for long periods on heat-generating sources such as amplifiers or near spotlights, etc. will affect product performance. Avoid placing the player on heat-generating sources.
- Install this compact disc player as far as possible away from tuners and TV sets. A compact disc player installed in close proximity to such equipment may cause noise or degradation of the picture.
- Noise may be noticeable when an indoor antenna is used. In such cases, make use of an outdoor antenna or turn off power to the compact disc player.
- When the unit is used in a loud-sound environment, e.g., near a speaker, sound skip may occur. Install the unit away from the speaker or reduce the listening volume.
- Place this unit on a level surface and a stable platform.
- Be sure the player, including its audio and power supply cords, does not touch vibrating materials. Any cause of vibration other than the insulators may cause the disc to skip. Take special care when using the player while it is installed in a carrying case.

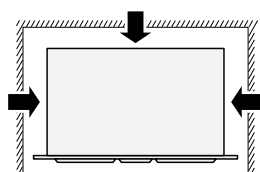
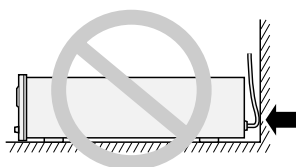

Do not place on or against vibrating materials!

Installing the CMX-3000 in an EIA rack

The screw holes on the front panel of the CMX-3000 are designed for use in attaching the unit to a 19-inch EIA rack.

- Remove the five legs on the unit before installing the unit in the rack.
- Attach the unit to the rack using screws of the appropriate size (screws not provided with the unit).

Note

- Never place this CD player directly above a power amplifier, as the heat given off by the amplifier might result in damage to the unit. Placing the CD player directly above a power amplifier might also result in ham radio signals being picked up or in other types of interference.
- Always be sure to remove the CD player from its rack before shipping.
- When moving the CD player while still installed in its rack, exercise caution to avoid subjecting the player to shocks or vibration.

Cleaning the player

To clean the PLAYER wipe with a polishing or a soft, dry cloth. For stubborn dirt, moisten a soft cloth with a weak solution of neutral detergent (diluted in five to six parts water), wring the cloth well, and wipe away the dirt. Use a dry cloth to wipe the surface dry. Do not use volatile liquids such as benzene or thinner which will damage to the unit.

CD lens cleaner

The player's pickup lens should not become dirty in normal use. If for some reason, the lens becomes soiled and malfunctions, contact your nearest PIONEER authorized service center. Lens cleaners for CD players are commercially available, but special care should be exercised in their use as some may cause damage to the lens.

Storing discs

- Discs are made of the same kinds of plastic used for conventional analog audio records. Be careful not to allow discs to warp. Always store discs in their cases vertically, avoiding locations with high heat, humidity, or extremely low temperatures. Avoid leaving discs in cars; the interior of a car in direct sunlight can become extremely hot.
- Always read and abide by the precautionary notes listed on disc labels.

Condensation

When this unit is brought into a warm room from previously cold surroundings or when the room temperature rises sharply, condensation may form inside the unit and impair its performance. In such cases, allow the unit to stand for about an hour or raise the room temperature gradually.

Cleaning and handling compact discs

- The presence of fingerprints or smudges on the surface of the disc will not directly affect the recorded signals, but, depending on the degree of contamination, the brightness of the light reflected from the signal surfaces may be reduced causing degradation of sound quality. Always keep your discs clean by wiping them gently with a soft cloth from the inner edge toward the outer edge.

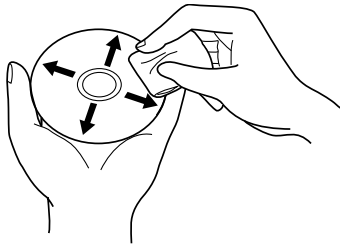

- If a disc becomes very dirty, dampen a soft cloth with water, (be sure to wring it out well) and wipe the away dirt gently. Remove any water drops with another soft, dry cloth.
- Do not use record cleaning sprays or anti-static agents on discs. Never clean discs with benzene, thinner, or other volatile solvents or damage to the disc surface may result.

- With this player, use only those discs which display the mark shown right (Optical audio digital discs).



- When holding discs, do not touch their signal surfaces. Hold by the edges, or by one edge and the center hole.
- Do not affix gummed labels or tape to the disc surface. Also, do not scratch or damage the label.
- Discs rotate at high speeds inside the player. Do not use damaged, cracked or warped discs.

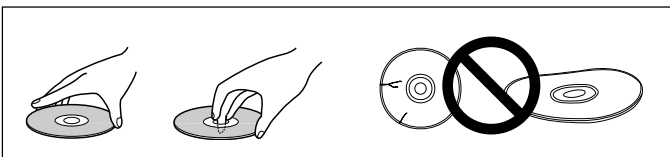

Do not play a CD with a special shape

Do not play a CD having other shape than a circular disc, such as heart shaped disc. Otherwise malfunction may occur.

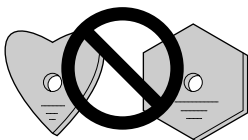

FORCED DISC EJECTION

If the EJECT button fails to work and it becomes impossible to eject a disc, the disc may be ejected by inserting the disc ejection pin in the manual disc ejection hole located on the front panel of the player.

Always be sure to observe the following points when manually ejecting discs.

- ① Be sure to turn off the power to the CD player and wait for 1 minute or more before ejecting the disc.



Manually ejecting a disc immediately after the power to the unit has been turned off may result in one of the following problems from occurring, and care should accordingly be taken never to eject discs immediately after the power has been turned off.

- The disc will still be spinning when it is ejected, thus resulting in cuts to the fingers or other forms of bodily injury.
 - The disc clamps will spin in an unstable state, thus resulting in scratching of discs.
- ② Be sure to use only the disc ejection pin included with your CMX-3000 (i.e., never use a paper clip or any other object). Inserting the disc ejection pin into the hole **until it encounters** resistance will cause the disc to be ejected some 5 to 10 millimeters from the insertion slot. The disc may then be removed by grasping it by hand and pulling.

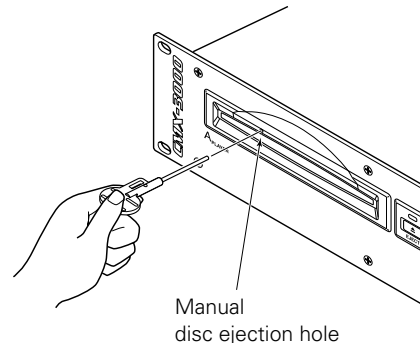

CONTENTS

Read before use

CAUTIONS REGARDING HANDLING	4
SPECIFICATIONS	6
FEATURES	7
PANEL FACILITIES	8
Player	8
Remote Control Unit	8
CONNECTIONS	10

Basic operation

DISC LOADING/UNLOADING	11
DJ PLAYER OPERATION	12
Auto Cueing	12
Starting Playback	12
Stopping Playback	12
Pausing Playback	12
Skipping Tracks	12
Fast Forward and Rewind	13
Cueing Point Settings	13
Changing Playback Speed	13
Setting a Master Tempo	13
Jog Dial Functions	14

Applications

ADVANCED OPERATIONS	15
Scratch Play	15
Hot Cue	15
Loop Playback	16
WAVE Display	16
CD TEXT Display	16
Mixing (Segueing) Different Tracks	17
Beat Synchro	17
Auto BPM Synchro	17
Fader Start Playback	18
Relay Play Using Two Players	18
Data Copy	18

Appendix

TROUBLESHOOTING	19
Error Message Display	20
Cleaning the Jog Dial	20

SPECIFICATIONS

1. General

System	Compact disc digital audio system
Discs used	Compact discs
Power requirements	AC 120 V, 60 Hz
Power consumption	49 W
Operating temperature	+5°C to +35°C (+41°F to +95°F)
Operating humidity	5% to 85%
	(There should be no condensation of moisture.)
Weight	
Remote controller	2.0 kg (4 lbs 7 oz)
Player	5.6 kg (12 lbs 6 oz)
Dimensions	
Remote controller	482 (W) x 132 (D) x 82 (H) mm 18-31/32 (W) x 5-3/16 (D) x 3-7/32 (H) in.
Player	482 (W) x 252 (D) x 90 (H) mm 18-31/32 (W) x 9-15/16 (D) x 3-9/16 (H) in.

2. Audio section

Frequency response	4 Hz to 20 kHz
Signal-to-noise ratio	115 dB or more
Distortion rate	0.006%

3. Accessories

● Operating instructions	1
● Power cord	1
● Audio cable	2
● Control cord	2
● Forced ejection pin	1
● Specialized connection cable for the remote controller	1
● Limited warranty	1

NOTE:

Specifications and design are subject to possible modification without notice.

FEATURES

The Pioneer CMX-3000 is a twin CD player designed for use by DJs which provides not only the features and performance required in a discotheque sound system in a CD player but also provides new features only possible in a CD player.

JOG DIAL

The large 110 mm diameter Jog dial enables better handling than an analog turntable.

● SCRATCH PLAY

When the jog dial is rotated in the SCRATCH mode, playback will occur in response to the direction and speed of jog-dial rotation.

● PITCH BEND

This function changes the music tempo depending on direction of Jog dial rotation and speed of movement.

● FRAME SEARCH

Moves the disc from pause position in frame increments (1/75 sec) when the Jog dial is rotated in pause mode.

● SUPER FAST SEARCH

You can search the disc faster than normal search or track search by holding down a SEARCH button or TRACK SEARCH button as you turn the Jog dial.

WAVE DISPLAY

This display makes it possible to find the breakpoint between tracks in advance and use it as mix point or end point in the same way as you can on an analog record by checking the position of the needle in the groove.

BPM SYNCHRO HOT CUE

Each of the players can be preset with up to three Hot Cue points (1, 2, 3), thus allowing you to begin play instantly from any of the points. Also, by setting the BPM with either auto or TAP button, that BPM value can be used for HOT CUE synchro playback.

TEMPO CONTROL

60 mm high-precision slider coupled with a 0.05% increment digital display (within a $\pm 6\%$ range) allows exact control of speed to make tempo adjustments easy and accurate.

● TEMPO CONTROL RANGE

The maximum variable range can be set to four variable ranges: $\pm 6\%$, $\pm 10\%$, $\pm 16\%$ and WIDE to facilitate adjustment.

● MASTER TEMPO

Changes music tempo without changing pitch.

CUE

● BACK CUE

After storing the Cue point in memory, press the CUE button while playing the unit to go back to the Cue point and start over.

● AUTO CUE

Auto cue automatically locates the song's start point even if it differs from the track's frame, allowing the player to start instantly at a press of the PLAY/PAUSE (▶||) button.

● CUE POINT SAMPLER

The sound from the memorized cue point can be reproduced by one touch, which can be used as the start point check and the sampler.

REAL TIME SEAMLESS LOOP

This function simplifies setting and releasing loops. This function lets you set a loop while you are playing a track. A loop can also be set at the end of the track so that the track does not stop. In addition, an ADJUST mode has been added to enable one-touch adjustment to the Loop-out point and facilitate loop operation.

RELOOP

Allows you to replay a loop any number of times.

Press the RELOOP button after releasing loop play to return to the loop start point. Clever use of on and off in combination with the rhythm make it possible to create new sound effects.

LOOP PLAY MEMORY

Loop information can be programmed in the HOT CUE button, so the desired loop play begins instantly when accessed.

EMERGENCY LOOP

When this function is used to designate a loop in-point, the loop out-point is automatically set and loop play begins.

PLAYING ADDRESS

This bar graph provides a visual representation of track playback progress that enables you to see current playback position just like you can on an analog record by checking needle position. The length of the bar shows current position and a flashing bar provides advance notice of track end.

SLOT IN

Discs are loaded directly without opening doors or trays, making track selection that much faster.

FADER START

QUICK START and BACK CUE can be performed using the fader function on DJ mixers DJM-500, DJM-600 and DJM-300 (all mixers are sold separately).

MULTI READ

CD-R, CD-RW discs can be replayed. (However, due to certain special characteristics of some discs, recorders as well as dirty or damaged discs, some discs may not replay properly.)

CD TEXT

CD TEXT informations are displayed if the CD includes the CD TEXT information.

PANEL FACILITIES

Operation buttons indicated by an asterisk (*) are not supported in digital mode.

Player

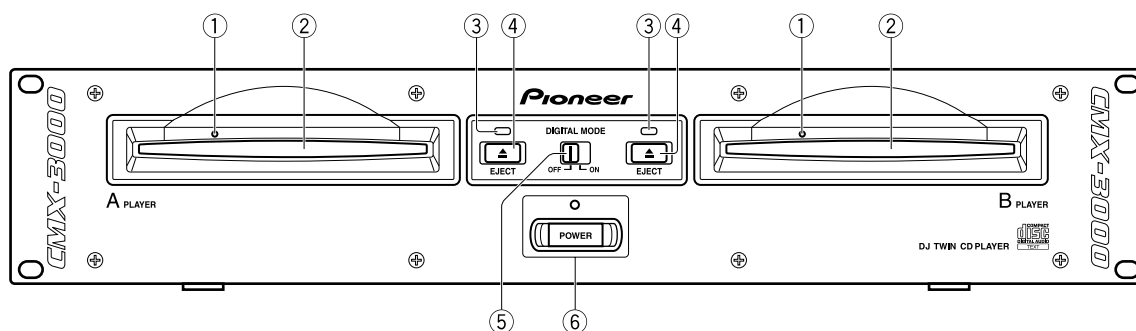

- ① **Manual ejection hole** (see p. 5)
- ② **Disc insertion slot** (see p. 11)
When using 3 inch/8 cm discs, discs must be inserted in the commercially available CD adapter before insertion.
- ③ **Disc loading indicator**
This indicator flashes when a disc is being inserted into or ejected from the disc insertion slot and lights up when a disc has been inserted.
- ④ **EJECT button (▲)**
Pressing this button while cueing is on standby or play is paused will eject the disc from the player.
- ⑤ **DIGITAL MODE switch** (see p. 11)
Set to On when the digital output is to be used. When set to On, the DJ functions do not function. (Functions marked * do not operate in this mode.) And the muted pause mode is used instead of the audible pause mode.
- ⑥ **POWER switch and indicator**
The following settings are maintained in the internal memory even when the power is turned off:
 - TEMPO RANGE
 - AUTO CUE
 - CD TEXT/WAVE
 - TIME MODE
 - MASTER TEMPO
 - AUTO CUE LEVEL

Remote Control Unit

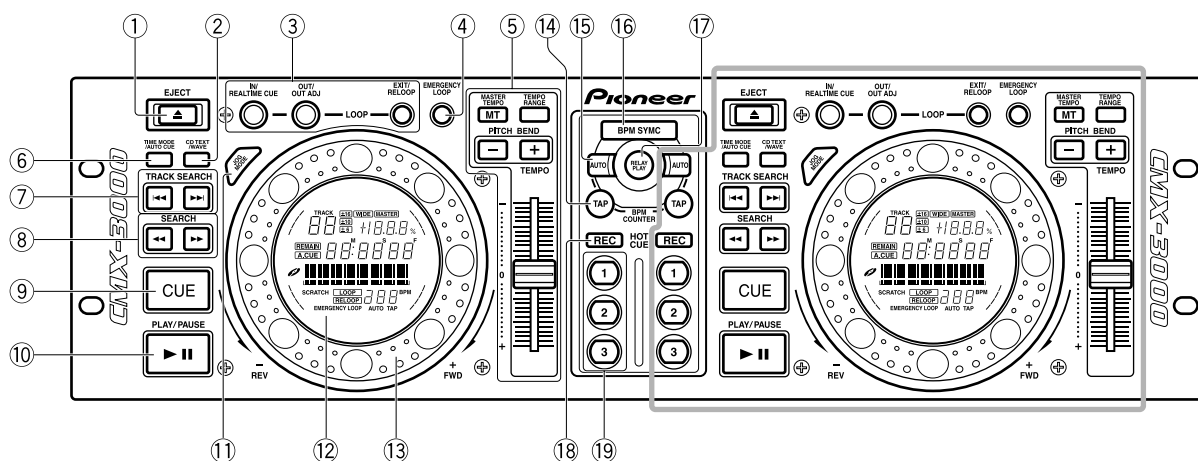

- ① **EJECT button (▲)**
- ② **CD TEXT/WAVE button** (see p. 16)
Each time the button is pressed the function changes alternately as follows:

→ WAVE display	→ CD TEXT	→ CD TEXT
	disc title display	track title display

 During digital mode, switches between
 CD TEXT ←→ CD TEXT
 disc title display track title display
- ③ **LOOP control buttons (*)** (see p. 16)
- ④ **EMERGENCY LOOP button (*)** (see p. 16)
When this button is pressed, the current point is set as the loop in-point, and loop play begins with an automatically set out-point.
- ⑤ **TEMPO controls (*)** (see p. 13)
 - Tempo control range button (TEMPO RANGE):**
Pressing this button causes the variable range of the tempo control slide to change each time the button is pressed.
 - MASTER TEMPO button and indicator:**
Pressing this button causes the master tempo feature to be powered on or off each time it is pressed.
 - Tempo control slide:**
Moving this slider in the positive (+) direction away from the center position (normal playback tempo) causes the tempo to become faster, and moving it in the negative (-) direction causes the tempo to become slower.
 - PITCH BEND buttons (+, -):**
When pressed during playback, causes pitch bend. Pressing the "+" button causes pitch to accelerate, while pressing the "-" button causes pitch to decelerate.

⑥ Time mode/Auto cueing button (*) (TIME MODE/AUTO CUE)

TIME MODE:

Pressing this button causes the elapsed time and remaining time (REMAIN) of the current track to be displayed in succession on the time display of the display unit.

AUTO CUE: (see p. 12)

⑦ TRACK SEARCH button (◀◀, ▶▶) (see p. 12)

⑧ SEARCH button (◀, ▶) (see p. 13)

⑨ CUE button and indicator (*)

Cueing point settings (see p. 13)

Cueing point sampler (see p. 13)

Back cueing (see p. 13)

Cueing point adjust (see p. 13)

⑩ PLAY/PAUSE button (▶ ||) and indicator (see p. 12)

⑪ JOG MODE button (*)

Each time this button is pressed, the jog mode switches alternately between CDJ jog mode and SCRATCH jog mode.

⑫ Display

⑬ Jog dial (+ FWD/- REV) (*) (see p. 14)

⑭ TAP button (*)

When pressed during playback, the BPM counter switches to manual mode, and the BPM value is calculated from the interval at which the TAP button is pressed. A BPM value in the range 40 to 199 BPM (varies with the tempo change rate) can be entered when the tempo change rate is 0%.

⑮ AUTO button (*)

Press for automatic BPM count

⑯ BPM synchro button (BPM SYNC) and indicator (*) (see p. 17)

Each time the button is pressed, switches BPM synchro function ON/OFF. BPM SYNC indicator flashes during ON, and lights steadily when OFF.

⑰ RELAY PLAY button and indicator (*) (see p. 18)

⑱ HOT CUE recording mode button (REC) and indicator (*) (see p. 15)

Press to switch the HOT CUE button's function (record/access). In the record mode, the indicator lights.

⑲ HOT CUE buttons (1, 2, 3) and indicator (*) (see p. 15)

Use to select the memory (1, 2, 3) into which you wish to program hot cue point information and loop information.

Display

① TRACK number display

Displays the track number of the track currently being played.

② Playback speed display

Tempo control range display (±6, ±10, ±16, WIDE)

Displays the variable range mode of the tempo control slide.

MASTER indicator

MASTER indicator on the master player lights during BPM synchro play.

Tempo change rate display

Displays the rate of change of the tempo as specified using the tempo control slide.

③ Ring display

During relay play, displays disc rotation status. During BPM synchro mode, the display occurs in rhythm with the beat.

④ Auto cueing indicator (A. CUE)

Lights up when auto cueing is turned on.

⑤ SCRATCH indicator

When jog mode is set to "SCRATCH," flashes during write to the scratch memory, and lights steadily when data is fully written to the memory.

⑥ EMERGENCY LOOP indicator

Flashes during loop play in the Emergency Loop mode.

⑦ RELOOP indicator

Lights to indicate loop play is possible, and during loop play.

⑧ LOOP indicator

Lights during loop play.

⑨ Automatic BPM Count indicator (AUTO)

Lights during automatic BPM count mode.

⑩ TAP mode indicator

Lights during TAP BPM count mode. Indicator goes out for approximately 0.2 second the instant TAP button is pressed.

⑪ Time display

Used to display the elapsed playback time (when the REMAIN indicator is unlit) or the remaining playback time (when the REMAIN indicator is lit) of the current track in minutes (M), seconds (S), and frames (F).

⑫ WAVE Display / Character Display

During WAVE display, indicates the volume level of the currently playing track. During character display, displays CD TEXT. Characters displayable are limited to alphabet, numerals, and certain symbols. The array displays either the disc title or the track title. When disc title is displayed, the  mark lights.

⑬ Playback position display

Used to display a full-scale bar graph for the track being played to make it possible to get an intuitive feel of the elapsed and remaining play time.

- Display as it appears when displaying elapsed time:
 - All indicators unlit and then indicators light up in sequence from left
- Display as it appears when displaying remaining time:
 - All indicators lit and then indicators are turned off in sequence from left
- Display as it appears when there are less than 30 seconds remaining in a track:
 - Slow flashing
- Display as it appears when there are less than 15 seconds remaining in a track:
 - Rapid flashing

⑭ BPM display

Used to display the number of BPM for the current track. Note that it may not be possible to count BPM in the automatic BPM count mode for some tracks. Then use the TAP BPM count mode to do this.

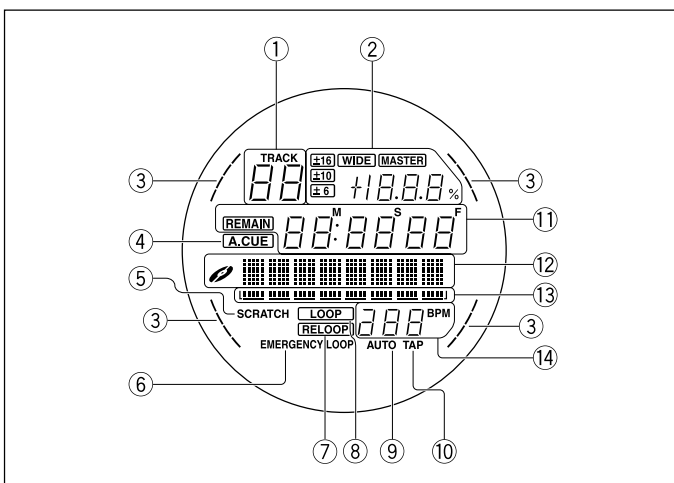

CONNECTIONS

Before connecting or disconnecting any cables, be sure to first turn off the power switch and remove the power cord from its socket. The CD player may be damaged if cables are connected when the power is on.

1. Connecting the player to the remote control unit

First connect the CD player to the remote control unit.

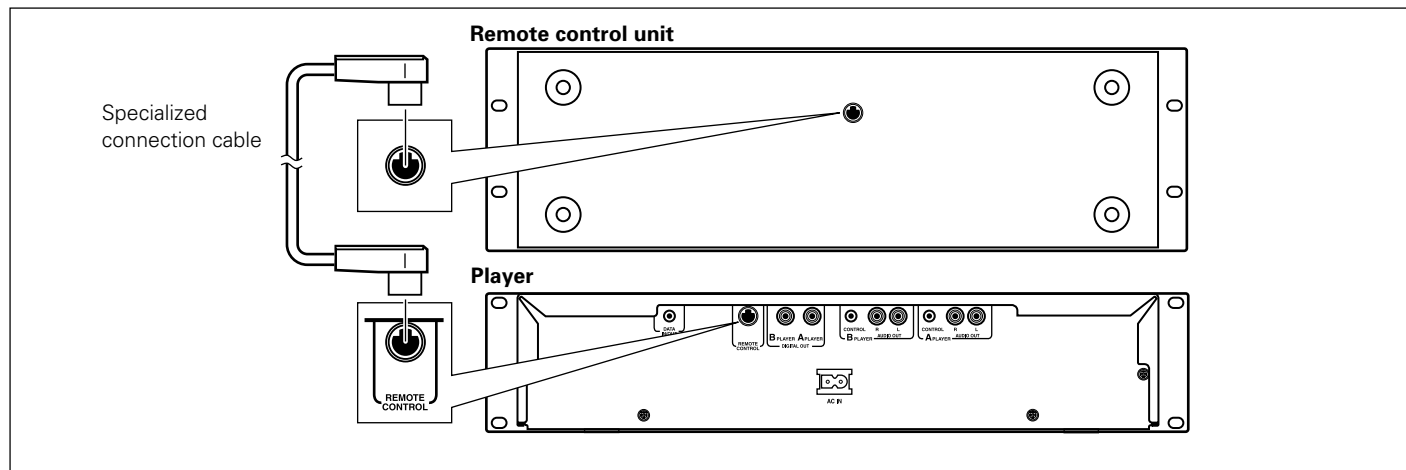

2. Connecting the system to a DJ mixer (DJM-300, DJM-500, or DJM-600) (connecting audio output and control jack cables)

Using the audio cables provided with your CMX-3000 CD player system, insert the white plugs into the left (L) jacks and the red plugs into the right (R) jacks. Note that it is also possible to use the CMX-3000 control cord to control the CMX-3000 from a mixer to make it possible to use fader startup or back cueing. (This does not apply, however, during relay playback.)

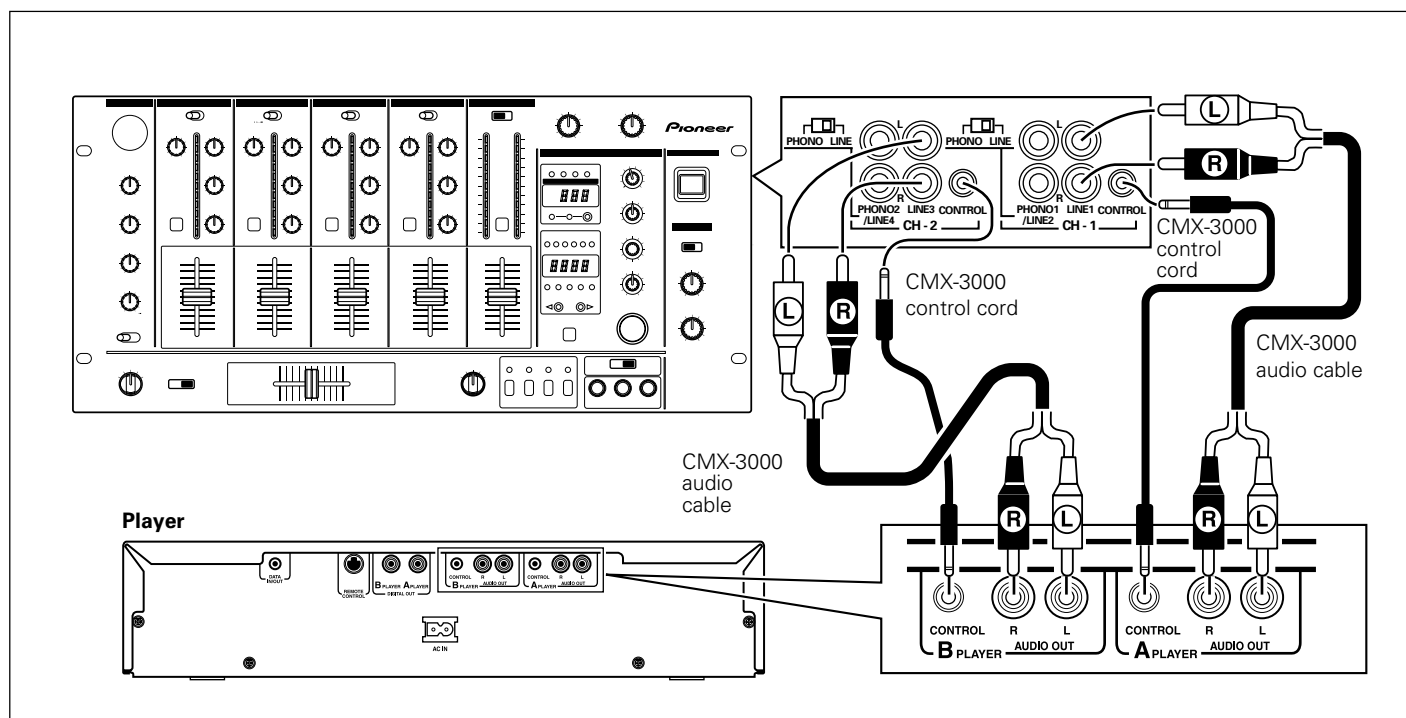

- When connecting to a DJM-300, DJM-500 or DJM-600 mixer, use the CMX-3000 audio cables to connect CD1 to A PLAYER and CD2 to B PLAYER as indicated in the diagram above.

3. Connecting the CMX-3000 to other devices

Ⓐ Connecting the CMX-3000 to other mixers

To connect the CMX-3000 to other mixers, connect the CMX-3000 AUDIO OUT jacks to the line input jacks or AUX jacks of the mixer. (Do not connect to PHONO jacks, as doing so would result in the sound being distorted and in being unable to obtain normal playback quality.)

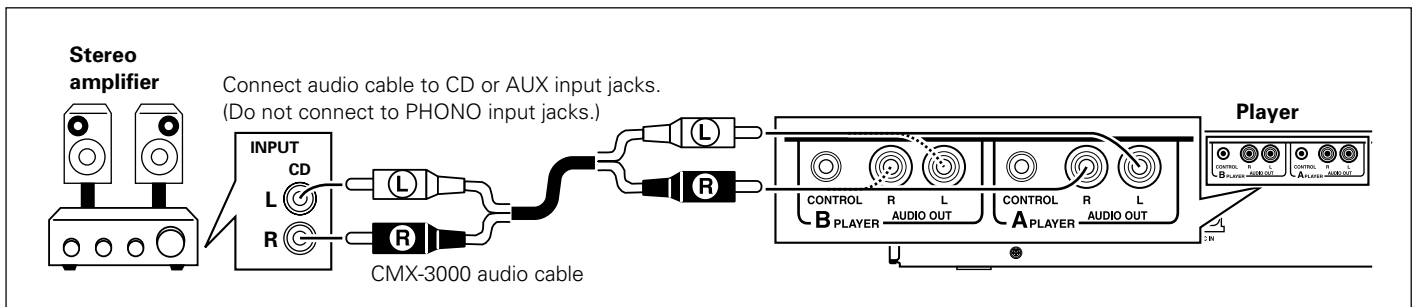
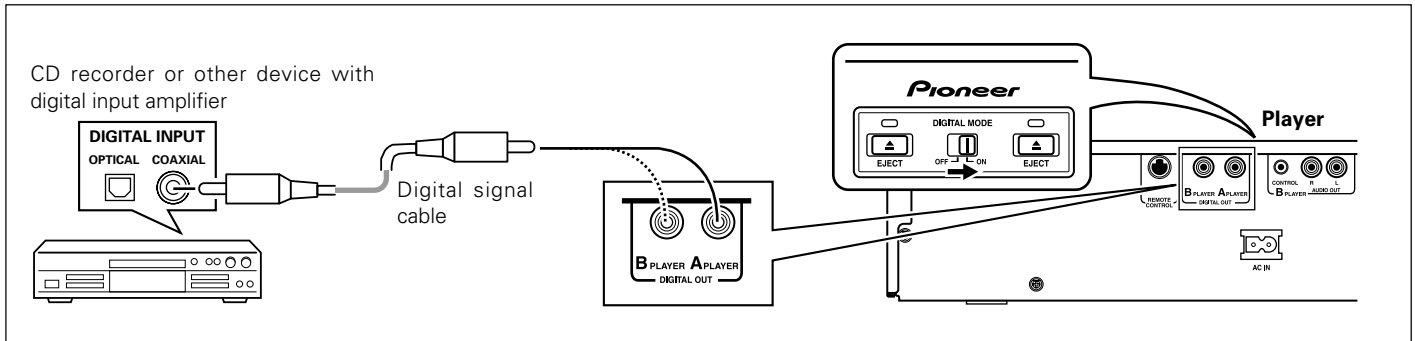
B Connecting the CMX-3000 to stereo amplifiers (when not using a DJ mixer)**C Connecting the CMX-3000 to devices with digital input jacks**

- When using the digital output jacks, the DIGITAL MODE switch must be set to 'ON'.

Note:

Turning the DIGITAL MODE switch 'ON' causes all DJ features (i.e., CUE, LOOP, RELOOP, TEMPO CONTROL, MASTER TEMPO, increase/reduce speed by the jog dial or HOT CUE) to be disabled. Also note that when using digital output pausing results not in a start playback pause but in a silent pause instead.

4. Connecting the power cord

When all connections have been made, connect the power cord to the AC inlet on the rear panel of the player and connect the power plug to an AC wall outlet or to a power receptacle on the rear panel of the amplifier.

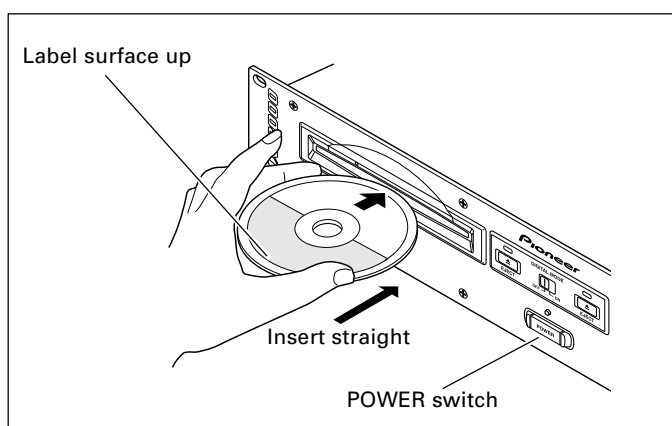
DISC LOADING/UNLOADING

1. Press **POWER** switch on front of player to turn power on.

Do not force a disc into the unit when the POWER switch is set to OFF as this may damage the disc and the unit.

2. Insert a disc.

- Hold the disc with label surface upwards, and insert into the front panel disc insertion slot.
- When playing an 3 inch/8 cm disc, place the disc in a commercially available CD adapter before inserting in the insertion slot.

- Each insertion slot can only accommodate one disc at a time. Never attempt to load more than one disc at the same time, or attempt to load a second disc when one disc has already been loaded.
- When loading a disc, do not place any twisting force on the disc, or try to force the disc into the slot. Also, do not attempt to interrupt or defeat the motion of the disc when the player begins to draw a disc into the slot or to eject a disc, since damage to the disc or player could occur.

3. During playback, press the PLAY/PAUSE button (▶||) or if a cue point has been specified press the CUE button to back-cue before pressing the EJECT button (▲) to eject a disc

- When the EJECT button is pressed, disc rotation stops and the disc is ejected from the loading slot.
- If the disc fails to be ejected when the EJECT button is pressed, the accessory forced eject pin can be inserted into the front-panel's forced eject hole to eject the disc. (see p. 5)

CAUTION:

Do not attempt to press a disc back into the slot when the EJECT indicator appears. Pressing a disc back into the slot while the EJECT indicator appears may cause the player to stop. In this case, press the EJECT button again and wait until the EJECT indicator goes out before reinserting the disc.

DJ PLAYER OPERATION

Operations indicated by * cannot be used when the DIGITAL MODE switch is set to on (and the digital output terminal is used).

Playing discs on Player A (Operation identical for Player B)

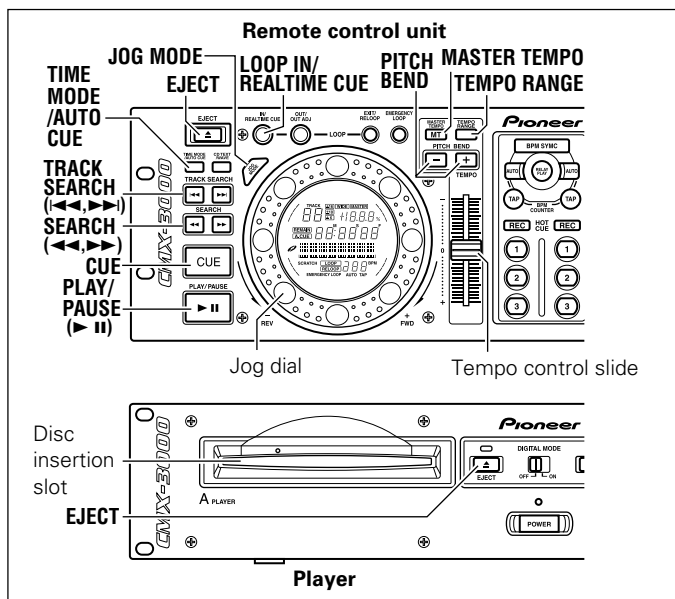

Once the first track has been played, the player will automatically search for the beginning of the next track to be played. The cueing indicator (CUE) will light up, the PLAY/PAUSE button indicator will flash, and the player will then wait for the PLAY/PAUSE button (▶||) to be pressed before beginning playback of the next track.

3. If auto cueing is off, playback will begin automatically from the first track.

- When auto cueing is off, playback will continue after the first track has been played, with all subsequent tracks being played in sequence.
- When playback of the final track is complete, playback will automatically come to an end.

Stopping Playback

During playback, press the PLAY/PAUSE button (▶||) or if a cue point has been specified press the CUE button to back-cue before pressing the EJECT button (▲) to eject the disc.

- Disc rotation stops and the disc is ejected.
- Note that the CMX-3000 does not come with a stop button.
- Pressing the EJECT button during playback has no effect.

Auto Cueing (*)

Auto cueing is used to automatically specify the cueing point (see p. 13) to be used before sound actually begins to play when inserting a disc or when performing track searching.

- Turning auto cueing on and off
Pressing the TIME MODE/AUTO CUE button and holding it down for a second or more causes auto cueing to be alternately turned on and off.
When auto cueing is on, the auto cueing indicator (A. CUE) will be lit up.
- **AUTO CUE** on/off status is stored in memory and persists even when the power is turned off.
- The Auto Cue level can be changed.

■ Varying the Auto Cue Level

1. Hold the TIME MODE/AUTO CUE button depressed for 5 seconds or more.
 - The display will show "A.CUE - 60" (when default setting).
2. Press the PITCH BEND buttons (+, -) to change the value.
 - The value can be changed to either -42 dB, -48 dB, -54 dB, or -60 dB.
 - Either press the TIME MODE/AUTO CUE button or else wait for 15 seconds; the variable level mode will be cancel.
 - This setting is written to non-volatile memory, and will not be changed when power is interrupted or disconnected.

Starting Playback

1. Insert a disc into Player A or Player B.
2. If auto cueing is on, press the PLAY/PAUSE button (▶||).
 - Wait for the CUE button indicator to light up before pressing the button. The silent portion at the beginning of the displayed track will be skipped and playback will begin instantaneously from the first bars of the track.

Pausing Playback

To pause playback, press the PLAY/PAUSE button (▶||).

- The PLAY/PAUSE button indicator and cueing indicator (CUE) will flash and playback will pause.
- Pressing the PLAY/PAUSE button again will then cause the button indicator to light up and for playback to be resumed.
- In the CDJ mode broken sound will still be audible during the standby mode; if you wish to stop all sound, lower the output sound volume on your audio mixer.
- If no operator whatsoever is performed for 80 minutes or more after pausing playback, the rotation of the disc will be automatically brought to a halt. Pressing the PLAY/PAUSE button at this time will then cause playback to be resumed.

Skipping Tracks

■ Skipping tracks using the TRACK SEARCH buttons (◀◀, ▶▶)

Press the forward or reverse TRACK SEARCH button (◀◀, ▶▶).

- Each time the button is pressed, the player will skip to the next track in the specified direction. (To skip to the previous track while a track is being played, press the reverse TRACK SEARCH button (◀◀) two times in succession.)
- Pressing the forward or reverse TRACK SEARCH button (◀◀, ▶▶) and holding down on the button will cause multiple tracks to be skipped in succession. Holding down the button for two seconds or more will cause the forward/reverse skipping speed to increase.
- Pressing the reverse TRACK SEARCH button (◀◀) at the beginning of the first track will cause the player to skip to the final track.
- Pressing the forward TRACK SEARCH button (▶▶) from the last track will cause the player to skip to the first track (i.e., Track No. 1).

■ Super-fast track searching

Turn the jog dial while pressing either TRACK SEARCH button (◀◀, ▶▶).

- Turning the jog dial in the direction you wish to skip while pressing the forward or reverse TRACK SEARCH button (◀◀, ▶▶) will cause the player to enter high-speed skipping mode, with the speed being adjusted in accordance with the degree to which the jog dial is turned.
- Tracks will be skipped in the same direction as that in which the jog dial is rotated. The direction indicated by the TRACK SEARCH button actually pressed will be ignored.
- Releasing the TRACK SEARCH button causes the player to leave high-speed skipping mode.

Fast Forward and Rewind

■ Using the SEARCH button (◀◀, ▶▶) to fast forward or rewind

During playback, press the forward or reverse SEARCH button (◀◀, ▶▶).

Pressing the forward SEARCH button (▶▶) and keeping it pressed will cause the CD to fast-forward. Pressing the reverse SEARCH button (◀◀) and keeping it pressed will cause the CD to rewind.

■ Super-fast searching

Turn the jog dial while pressing either SEARCH button (◀◀, ▶▶).

- Turning the jog dial in the direction you wish to search while pressing the forward or reverse SEARCH button (◀◀, ▶▶) will cause the player to enter high-speed fast-forward or high-speed reverse mode.
- CD will be searched in the same direction as that in which the jog dial is rotated. The direction indicated by the SEARCH button actually pressed will be ignored.
- Playback will resume when the jog dial is no longer being turned.
- Releasing the SEARCH button causes the player to leave high-speed search mode.

Cueing Point Settings (*)

Once a cueing point has been stored in memory, it can be used to place the player in a state where it is ready to begin playback from the cueing point by pressing the CUE button.

■ Manual cueing

1. During playback, press the PLAY/PAUSE button (▶||) to pause playback at the point from which you wish to begin playback.
2. Search for the precise position of the cueing point.

■ Using frame numbers to specify cueing points

Cueing points may be specified in 1-frame units (where 75 frames are equivalent to 1 second).

Use the jog dial or the forward or reverse SEARCH button (◀◀, ▶▶) to advance to the desired frame. Rotating the jog dial once causes the player to advance or rewind 75 frames in the specified direction. Similarly, pressing the forward or reverse SEARCH button causes the player to advance or rewind 1 frame in the specified direction.

■ Listen to the sound at the current frame to determine the cueing point

Turn the jog dial slowly and then return it to just before the point from which you wish to begin playback. (The cueing point thus defined will consist of that point directly after the sound which can be heard during a cueing pause.)

3. Press the CUE button when you reach the desired frame number or hear the sound at the point from which you wish to begin cueing.

- When the sound is muted and the cueing indicator (CUE) lights up, the cueing point will have been stored to memory.
- Each time a new cueing point is stored to memory, the previous cueing point will be cleared from memory.

■ Real-time cueing

During playback, press the LOOP IN/REALTIME CUE button at the desired cueing point.

This point will then be recorded as the new cueing point.

■ Checking cueing points (Cueing point sampler)

After specifying a cueing point, press the CUE button.

- The sound at the specified cueing point will continue to play as long as the CUE button is pressed.

■ Returning to a cueing point (Back cueing)

1. During playback, press the CUE button.

- The player will return to the specified cueing point.

2. Press the PLAY/PAUSE button (▶||).

- Playback will begin immediately from the specified cueing point.

■ Changing cueing points (Cueing point adjust)

1. During playback, press the CUE button.

- The player will return to the currently specified cueing point.

2. Press the forward or reverse SEARCH button (◀◀, ▶▶).

- The cueing point will be shifted forward or backward in 1-frame units.

- The cueing point may also be shifted forward or backward by pressing the forward or reverse SEARCH button (◀◀, ▶▶) and then turning the jog dial.

3. Press the CUE button.

- The point where the CUE button is pressed will become the new cueing point.

Changing Playback Speed (*)

Pull the tempo control slide towards you.

Slide the knob towards you (+) to increase the tempo and slide it away from you (-) to decrease it.

- The rate of change in playback speed (tempo) is shown in the display.
- The playback speed can be changed without changing the pitch (ⓘ "Setting a Master Tempo").

■ Selecting the tempo adjust range

Press the TEMPO RANGE button.

Each time the button is pressed, the range of adjustment possible with the tempo control slide changes (±6%, ±10%, ±16%, WIDE). At ±6%, the adjustment unit is 0.05%, at ±10% and ±16%, the adjustment unit is 0.1%. When set to WIDE and the tempo can be set in adjustment units of 0.5% in the range ±100%.

- The selected variable adjustment range is shown on the display.

Setting a Master Tempo (*)

During playback, press the MASTER TEMPO button.

When this is done, the MASTER TEMPO will light, and even if the tempo control slide is used to change the speed (tempo), the sound (key, pitch) will not change.

- Since sound is produced digitally in this mode, the sound quality will change.

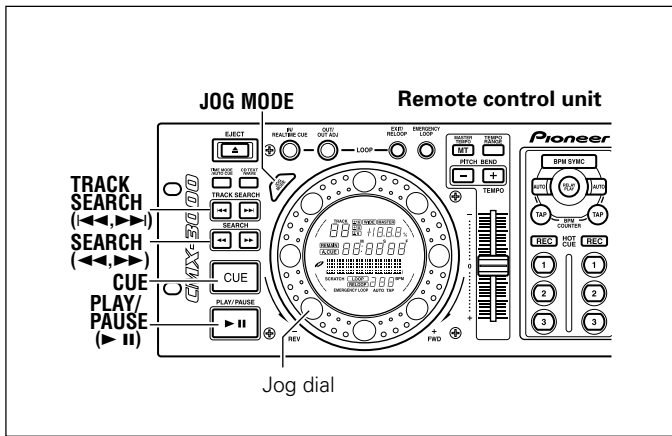

Jog Dial Functions (*)

1. Using the jog dial during playback (Pitch bend)

- Rotating the jog dial during playback causes the speed to be accelerated (when rotated in the FWD+ direction) or slowed down (when rotated in the REV- direction) in accordance with the degree to which the dial is turned.
- Once the jog dial is no longer being turned, playback resumes at its original speed.

2. Rotating the jog dial during playback (Scratch play)

See page 15: "Scratch Play".

3. Using the jog dial while playback is being paused (Frame searching)

- Rotating the jog dial causes the player to begin searching in 1-frame units.
- Rotate the jog dial at a fixed speed in the FWD+ direction for playback at normal speed.

4. Rotating the jog dial after pressing the SEARCH button while waiting for cueing (Cueing point search)

Pressing either of the SEARCH button (◀◀, ▶▶) while waiting for cueing causes the player to enter cueing pause mode, and rotating the jog dial at this time causes the player to search for possible cueing points. Pressing the CUE button after the player has advanced or rewound to a new cueing point will then cause the new cueing point to be entered into memory.

5. Rotating the jog dial while pressing the SEARCH button during playback (Super-fast searching)

Rotating the jog dial in the direction you wish to search while pressing the forward or reverse SEARCH button (◀◀, ▶▶) will cause the player to enter high-speed search mode.

6. Rotating the jog dial while pressing the TRACK SEARCH button (Super-fast track searching)

Turning the jog dial in the direction you wish to search while pressing the forward or reverse TRACK SEARCH button (◀◀, ▶▶) will cause the player to enter high-speed track search mode, with the direction and speed of searching being adjusted in accordance with the direction and degree in which the jog dial is turned.

ADVANCED OPERATIONS

Operations indicated by * cannot be used when the DIGITAL MODE switch is set to on (and the digital output terminal is used).

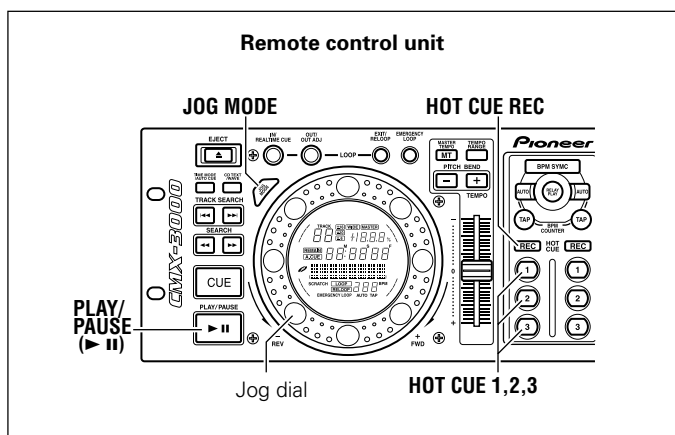

Scratch Play (*)

When the jog mode is set to SCRATCH, rotating the jog dial causes the disc to play in the direction and speed corresponding to the direction and speed in which the jog dial is turned.

1. Press the JOG MODE button.

- The SCRATCH indicator will flash and data is stored in the memory. When all data is stored in the memory, the SCRATCH indicator lights steadily. If the jog dial is moved harshly while the indicator is flashing, the sound may skip.

2. Rotate the jog dial in the direction and at the speed you wish playback to occur.

- Disc play will occur in response to the jog dial's direction and speed of rotation.

3. Stop jog dial operation.

- CD playback will return to its original status.
- When the SEARCH button is pressed during a pause in the SCRATCH jog mode, the playback mode changes from slow to normal playback and search depending on how long the button is held down.

Hot Cue (*)

Up to three Hot Cue points (1, 2, 3) can be programmed in the memory, allowing you to begin playback instantly from either of those points.

Cue points and loop points can also be programmed in the memory and recalled with one touch.

■ Setting a Hot Cue Point

1. Press the HOT CUE REC button to set the HOT CUE recording mode (the REC button lights).

2. During playback or playback pause, press either HOT CUE button 1, 2, or 3 at the place you wish to set as a Hot Cue point.

- The pressed button will flash for 2 seconds then light steadily.
- If Hot Cue is set during cueing pause or cue standby, the cue point and loop information (when LOOP indicator is lighted) will be recorded.

3. After completing the setting, press the HOT CUE REC button to switch to access mode (the button light goes out).

■ Hot Cue start

1. During playback, during pause, or during cue standby, press the HOT CUE button (1, 2, or 3) programmed with the desired start point.

- Playback will begin instantly from the programmed point.
- If loop information is programmed into the HOT CUE button, loop playback will begin.

■ Hot Cue Information Programming and Restoring

- Hot Cue information is programmed in the player's memory at the time a disc is removed from the player.
- A restore must be performed to use programmed Hot Cue setting information for the next disc. The Hot Cue button will flash when previously Hot Cue setting information is present upon the insertion of a disc. When the flashing HOT CUE button is pressed, the REC button will flash and the information will be restored. When the Hot Cue point has been restored, the REC button light will turn off, and the HOT CUE button will light steadily. If programmed Hot Cue information is not to be used, press the REC button to turn off the flashing HOT CUE button. To restore again, insert the disc again.
- The player's memory is non-volatile, so information programmed in the player's memory will be maintained even if power is interrupted or disconnected. Including WAVE information, the memory is capable of holding information on about 1000 CDs. If the memory becomes full, the memory is automatically overwritten, beginning with the oldest, most infrequently used information.
- Setting contents for the original disc cannot be read in the case of discs copied to CD-R or CD-RW, however.

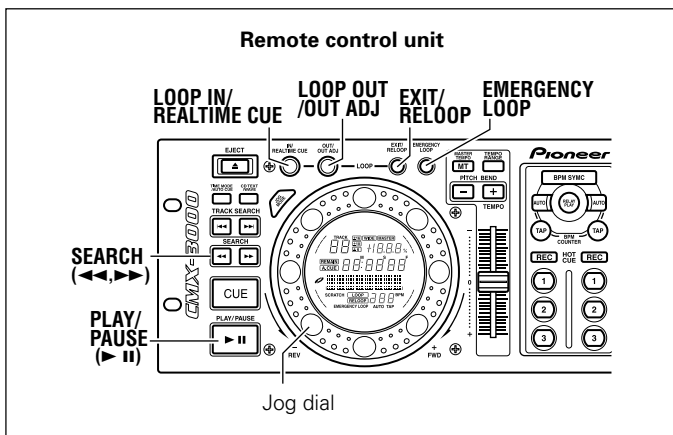

Loop Playback (*)

■ Defining a loop

1. Press the **PLAY/PAUSE** button (▶||) to begin playback.
2. During playback, press the **LOOP IN/REALTIME CUE** button at the point from which you wish to start the loop.
 - Note that this operation need not be performed if a prerecorded cueing point is to be used as the loop in-point.
3. During playback, press the **LOOP OUT/OUT ADJ** button at the point from which you wish to end the loop.
 - Loop playback will begin, with playback looping from the loop in-point to the loop out-point.

■ Stopping loop playback

- During loop playback, press the EXIT/RELOOP button.**
- Once this has been done, playback will continue in sequence from the loop out-point without returning to the loop in-point.

■ Changing the loop out-point

1. During loop playback, press the **LOOP OUT/OUT ADJ** button.
 - The loop out-point time will be displayed on the display panel, the LOOP OUT/OUT ADJ button will begin flashing rapidly, and the IN/REALTIME CUE button will be unlit.
2. Press the forward or reverse **SEARCH** button (◀◀, ▶▶) or turn the **Jog dial**.
 - The loop out-point will be shifted forward or backward in 1-frame units.
 - Pressing the LOOP OUT/OUT ADJ button or waiting for 30 seconds or longer will cause the player to exit from update loop input point mode and to resume loop playback.

■ Returning to loop playback

- After loop playback has been stopped, press the EXIT/RELOOP button during playback to return to loop playback.**
- The player will return to the currently defined loop in-point and begin loop playback (i.e., relooping) again from that point.

■ To program Loop play information

Loop play information can be programmed into a HOT CUE button to allow one-touch loop play. See the section "Hot Cue" (p. 15).

■ To automatically set loop end (Emergency Loop) During playback, press the EMERGENCY LOOP button.

- Normal loop play display occurs (button flashes and LOOP indicator lights), and EMERGENCY LOOP indicator flashes.
- The point at which the button is pressed becomes the loop in-point, and a loop out-point will be set automatically as follows:
 - If the immediately preceding BPM value is known, the loop out-point will be set 4 beats after the loop in-point.
 - If the immediately preceding BPM value is not known, the loop out-point will be set 4 seconds after the loop in-point.
 - If either of the above conditions (4 beats later or 4 seconds later) occurs later than the track end, the track end will be set as the loop out-point.
- If the EXIT/RELOOP button is pressed, loop playback is canceled and normal playback resumes.

WAVE Display (*)

This display shows the track's low tone beats (bass drum, etc.), thus letting you know the track's break points and end points.

- Together with playback of the current track, the WAVE is displayed. Once displayed, the WAVE information is memorized, so that it will be displayed immediately next time. Setting contents for the original disc cannot be read, however, in the case of discs copied to CD-R or CD-RW.
- Up to 99 tracks can be memorized for each disc.
- In the event a track has little change in low-register beat levels, the break point may not be displayed correctly.
- During playback, if operations such as scan, jog dial, or pause are attempted, the WAVE data may fail to be recorded in the vicinity where the said operation was attempted. In that case, rerecording of the WAVE data is required.

CD TEXT Display

CDs supporting CD TEXT function will show a consecutively scrolling display of the disc title and track title (limited to alphanumeric and certain symbol characters). During display of the disc title, the  disc mark lights.

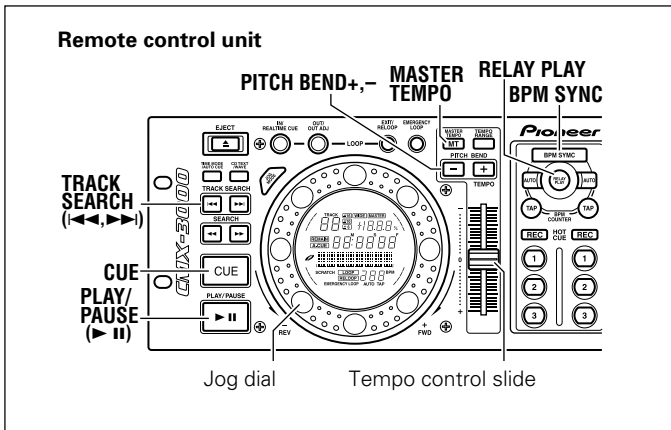

Mixing (Segueing) Different Tracks (*)

Example:

To use a DJ mixer to mix the sounds of the track currently playing (Player A) and heard from the speakers, with the sounds of the subsequent track B (in Player B).

- Connect Player A to the CH1 input port and Player B to the CH2 input port of the DJ mixer.
 - Raise the trim, channel faders, and master VR of the DJ mixer to the desired level so that sound is output from Player A.
- 1. Slide the CROSS FADER control on the DJ mixer to the left (CH1 side).**
 - Sound from track A will then be output from the speakers.
 - 2. Insert a disc into Player B.**
 - 3. Press the forward or reverse TRACK SEARCH button (◀◀, ▶▶) on Player B to select track B.**
 - 4. Press the PLAY/PAUSE button (▶||). (Note that auto cueing must be turned on.)**
 - 5. Use the DJ mixer MONITOR SELECTOR button to monitor CH2.**
 - 6. Turn the DJ mixer MONITOR LEVEL dial to output the sound from track B to the headphones.**
 - Speaker output will come only from track A.
 - 7. Listening to the sound from the headphones, cue to the opening of track B.**
 - ① Set player B to playback, and measure the BPM.
 - If BPM is not displayed, either try playing back a bit longer than usual, or use the TAP button to manually input the BPM.
 - ② Press the PLAY/PAUSE button (▶||) in the vicinity of the area you wish to cue the track.
 - Player B will enter cueing pause mode.
 - ③ Turn the Player B jog dial to find the cueing point (i.e., the opening bar).
 - ④ Once the cueing point has been found, press the Player B CUE button.
 - The sound will be muted and cueing will have been completed.
 - 8. Listening to the sound from track A from the speakers, wait for the press the Player B PLAY/PAUSE button (▶||).**
 - Speaker output will come only from track A.
 - Sound from track B will be output to the headphones.

9. Adjust the speed of track B to the speed (BPM= beats per minute) of track A.

Adjust the Player B tempo control slide so that the number of BPM displayed for track B is the same as the number of BPM displayed for track A.

- If you do not wish to change the pitch or key of track B, press the Player B MASTER TEMPO button before adjusting the tempo control slide.
- Once the number of BPM displayed for both tracks are the same, the tempo adjustment will have been finished.

10. Press the Player B CUE button.

- Player B will then enter standby mode at the cueing point.

11. Listening to the sound from track A from the speakers, wait for the correct timing and then press the Player B PLAY/PAUSE button (▶||).

- Track B will then begin to play.

12. While checking the sound from the headphones, gradually shift the DJ mixer CROSS FADER control to the right.

- The sound from track A coming from the speakers will become mixed with the sound from track B.
- When the DJ mixer CROSS FADER control has been shifted all the way to the right, the segueing from track A to track B will have been completed.

■ Long mixed playback

As long as the number of BPM is the same, track A and track B may be cleanly mixed even with the CROSS FADER control set in the middle.

■ Fader start playback

If the DJM-300, DJM-500, or DJM-600 cross fader start feature is used, step 11 above may be omitted, thus making it even easier to perform mixing. If the CROSS FADER control is also returned to its original position, it will cause the player to return to the state described in step 10, thus making it possible to perform cueing repeatedly.

Beat Synchro (*)

After synchronizing the tempos of Player A and Player B, the Pitch Bend function can be used to adjust the timing of the beat. For example, if you wish Player A to be the reference for beat timing, if the beat timing on Player B lags behind that of Player A, slowly rotate the jog dial on Player B in the clockwise direction. When this is done, Player B's playback speed will gradually become faster; release the jog dial at the point the beat timing of Player A and Player B are in synch. When the dial is released, the tempo returns to normal, and the synchronized beat timing is maintained.

If Player B's beat timing is in advance of Player A's, slowly rotate Player B's jog dial counterclockwise. When this is done, Player B's playback speed will gradually slow; when the beat timing of Player A and Player B are in synch, release the jog dial.

Besides the jog dial, Beat Sync can also be achieved by pressing the PITCH BEND + or - buttons.

Auto BPM Synchro (*)

This function can be used to automatically synchronize the BPM of two players (A, B). The currently playing player is called the "master"; this player's BPM is used as the reference for setting the BPM of the second player currently in pause or CUE mode (the "slave"), or a program tempo recorded in the HOT CUE button.

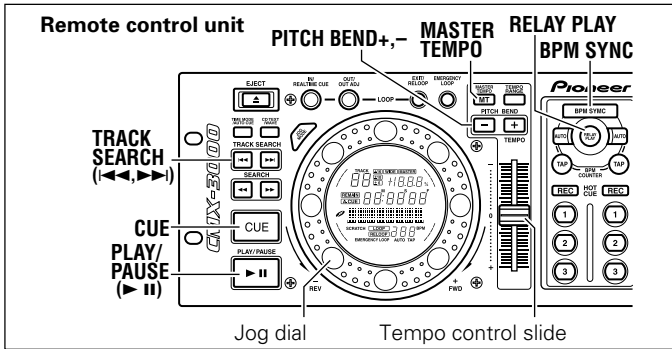

Press the BPM SYNC button.

- The BPM SYNC button will flash and the player enters the BPM synchro playback mode.
- If both players are currently in playback mode, no synchronization is possible until playback is stopped on one of the players. When one player is stopped, the player still playing back is considered the master.
- If start is begun when the BPM on the slave player is unknown, synchro playback will begin at the point the slave's BPM value is measured.
- During BPM synchro, the MASTER indicator will light on the "master" player's display. On the slave player, the tempo control range display will turn off and the tempo change rate display will show the tempo compensation value.
- During BPM synchro, the slave player's tempo will change to match any tempo changes on the master side. In this case, the tempo and pitch bend of the slave player cannot be independently adjusted.
- If playback is interrupted on the master player, the slave player will become the master. When this occurs, if the tempo control of the new master player is at a different setting from the tempo of the currently playing track, the display will alternately show the message dEc (or Inc), and the amount of tempo deviation. To reduce the tempo deviation to zero, move the tempo control slide to the "-" side if dEc is displayed, and to the "+" side if Inc is displayed. Speed control using the tempo control slide becomes possible when the tempo has been adjusted.

■ Correcting beat timing

- When beat is detected during BPM synchro, the ring display will light to graphically indicate the four-beat timing.
- The four-beat timing of the currently playing track on players A, B can be designated by tapping the TAP button with that timing once on each of the two players. The beat timing of the slave player will be automatically brought into correspondence with that of the master player, so as to match the designated beat timing.

NOTES:

- It may not be possible to correctly measure the BPM value for some tracks. If this happens, press the TAP button in time with the beat to enable a more accurate BPM synchro playback. However, if the BPM synchro range is outside the adjustable range of the player, appropriate BPM synchro playback may not be possible.
- During BPM synchro, the tempo control slide and pitch bend operations are disabled on the slave player.

Fader Start Playback (*)

The provided control cable may be used to connect the control jack on the CMX-3000 to a control jack on a DJM-300, DJM-500, or DJM-600 mixer, thus making it possible to exit from cueing standby mode and to start playback immediately by raising the DJ mixer CHANNEL FADER. The CROSS FADER may also be used to perform fading starts on the player as well. The fader may also be returned to its original position to return the player to the cueing point (i.e., to perform back cueing). (This does not apply, however, during auto playback.) (See p. 10 for instructions on how to connect the player and mixer.)

Relay Play Using Two Players (*)

- Set both player's auto cue function to ON (the A. CUE indicators will light in the displays).
- Set your DJ mixer's fader control to its center position.

1. Press the RELAY PLAY button to blink the button indicator.
2. Begin playback on the first player.
3. When the currently playing track ends, playback will begin automatically on the standby player.
4. The first player will enter cue standby mode at the beginning of the next track on its disc.
 - By repeating this operation, the two players can be used to perform continuous relay play.
 - By loading new discs on the standby player, you can construct a continuous program of whatever tracks you wish.
 - By setting a Cue point on the standby player, you can perform relay to any desired Cue point on the selected track (see page 13: Cueing Point Settings).

NOTES:

- Fader start and relay play cannot be performed simultaneously.
- When the Auto Cue function is off, replay will be performed of the entire disc.

Data Copy

WAVE and other data recorded in this unit can be copied to another CMX-3000 if desired.

1. With the unit power off, use a control cord to connect the two player's DATA IN/OUT connectors.
2. On each CMX-3000, turn on power while simultaneously pressing the EJECT buttons on players A and B. (The remote control unit's EJECT button cannot be used for this operation.)
 - The power will turn on, and data copy mode (slave mode) will be established; the display will show "SLAVE M".
3. With both units in the data copy mode ("slave mode"), press the CD TEXT/WAVE button on the player A holding the WAVE data you wish to copy. Hold the button depressed for one second.
 - This unit will enter the master mode and the display will show "MASTER."
4. Press the PLAY/PAUSE button (▶||) of Player A on the "master" unit.
 - Data copying will begin, and the ▶|| indicator will flash.
 - About ten minutes will be required for the copy operation. END is displayed on the master when copying is completed.
5. Turn off the power on both units and disconnect the control cord.
 - When power is turned on again, operation will return to normal mode.

NOTES:

- Do not turn off the power or disconnect cables during copying to prevent corruption of the copying data.
- If the ERROR message is displayed during data copy, check your connections and perform the data copy function again.

TROUBLESHOOTING

If you believe your CD player is failing to work properly, check the following troubleshooting table for tips. Sometimes simple mistakes in setup or operation may appear like serious problems. There are also times when the problem in question may be caused by something else other than your CD player, and at times like these you should check any other electronic devices being used at the same time.

If the problem in question continues to persist even after checking the troubleshooting table below and taking whatever corrective action is recommended, contact your nearest Pioneer Service Station or contact the store from which you purchased your player for further assistance.

Description of problem	Possible cause of problem	Recommended action
A disc fails to be ejected even after the EJECT button (▲) has been pressed.	<ul style="list-style-type: none"> ● Power cord has not been plugged in. ● A track is being played back. ● EJECT button (▲) is broken. 	<ul style="list-style-type: none"> ● Plug in power cord. ● Set the player to pause or cue standby mode before pressing the EJECT button (▲). ● See p. 5.
Playback doesn't begin even when a disc is inserted.	<ul style="list-style-type: none"> ● Auto Cue function is turned ON. 	<ul style="list-style-type: none"> ● Press the PLAY/PAUSE button (▶) to begin play. ● Hold the TIME MODE/AUTO CUE button depressed for 1 second or more to set the Auto Cue mode to OFF.
Playback comes to a halt almost immediately after it begins.	<ul style="list-style-type: none"> ● Disc has been inserted upside down. ● Disc is dirty or covered with condensation. 	<ul style="list-style-type: none"> ● Reinsert with label side facing upward. ● Wipe disc to remove dust or condensation.
No sound is output.	<ul style="list-style-type: none"> ● Audio cable has come loose or has not been properly plugged in. ● DJ mixer is not working properly. ● Jacks or jack plugs are dirty. ● Player is currently in pause mode. 	<ul style="list-style-type: none"> ● Plug in audio cable properly. ● Check switch and volume settings on DJ mixer. ● Wipe away dust or dirt and reinsert plugs. ● Press the PLAY/PAUSE button (▶) to begin play.
Sound is distorted or full of noise.	<ul style="list-style-type: none"> ● Audio cable has not been properly plugged in. ● Jacks or jack plugs are dirty. ● Player is subject to noise from a nearby television set. 	<ul style="list-style-type: none"> ● Connect audio cable to line input jack of DJ mixer. Do not connect to microphone jack. ● Wipe away dust or dirt and reinsert plugs. ● Turn off power to television set or move television set further away from CD player.
A large amount of noise is generated when playing back a certain disc or discs. Playback halts unexpectedly.	<ul style="list-style-type: none"> ● Disc is seriously warped or scratched. ● Disc is unusually dusty or dirty. 	<ul style="list-style-type: none"> ● Replace with new disc. ● Wipe away dust or dirt from disc.
Track searching fails to halt with Auto Cue function turned ON.	<ul style="list-style-type: none"> ● Track searching sometimes takes longer than expected when the length of silent portions between tracks is unusually long. ● If the length of a silent portion between two tracks is longer than 10 seconds in duration, the second track cannot be played back unless Auto Cue function is turned OFF. 	<ul style="list-style-type: none"> ● Hold the TIME MODE/AUTO CUE button depressed for 1 second or more to set the Auto Cue mode to OFF.
The jog dial doesn't work.	<ul style="list-style-type: none"> ● The DIGITAL MODE switch is set to ON. 	<ul style="list-style-type: none"> ● Set the DIGITAL MODE switch to OFF.
The jog dial performs a different function from that desired.	<ul style="list-style-type: none"> ● The jog mode is incorrect. 	<ul style="list-style-type: none"> ● Press the JOG MODE button to select the desired function.
Back cueing fails to work when the CUE button is pressed during playback.	<ul style="list-style-type: none"> ● No cueing point has been defined. ● The DIGITAL MODE switch is set to ON. 	<ul style="list-style-type: none"> ● Specify the desired cueing point. (See p. 13.) ● Set the DIGITAL MODE switch to OFF.
Unable to produce loop playback by pressing the LOOP OUT/OUT ADJ button.	<ul style="list-style-type: none"> ● No cueing point (i.e., starting point) has been defined. ● The DIGITAL MODE switch is set to ON. 	<ul style="list-style-type: none"> ● Specify the desired cueing point. (See p. 13.) ● Set the DIGITAL MODE switch to OFF.
Unable to perform DJ operations	<ul style="list-style-type: none"> ● The DIGITAL MODE switch is set to ON. 	<ul style="list-style-type: none"> ● Set the DIGITAL MODE switch to OFF.
Auto cue and other settings are not stored.	<ul style="list-style-type: none"> ● The power was turned off right after a setting was made. 	<ul style="list-style-type: none"> ● Wait 10 seconds before turning off the power after a change.
WAVE data is not stored.	<ul style="list-style-type: none"> ● The data is stored when playback of the current track is completed. 	<ul style="list-style-type: none"> ● Wait until playback of the current track is completed.
HOT CUE data is not stored.	<ul style="list-style-type: none"> ● The HOT CUE data is stored in memory when the disc is ejected. 	<ul style="list-style-type: none"> ● Eject the disc. (Then turn off the power.)
Television pictures are distorted or noise appears in FM broadcasts.	<ul style="list-style-type: none"> ● Interference caused by CD player. 	<ul style="list-style-type: none"> ● Turn off the power to the CD player or move the player further away from the radio or television set.
Disc is not rotating even though power has been turned on.	<ul style="list-style-type: none"> ● Disc rotation is automatically halted when no operation is performed for 80 minutes or longer when in pause mode. ● When the last track on the disc is over the disc stops rotating. 	<ul style="list-style-type: none"> ● Press the PLAY/PAUSE button (▶) to begin playback. Alternatively, press the EJECT button (▲) to eject the disc.

- There may be times when the CMX-3000 fails to operate properly as a result of static electricity or some other form of interference from an outside source. If any such problem occurs, turn off the power to the CMX-3000, wait for the currently inserted disc to come to a full stop, and then turn on the power again to see if that fixes the problem in question.
- The CMX-3000 cannot be used to replay partially-written CD-R or CD-RW discs.
- The CMX-3000 cannot be used to replay non-standard-shaped discs or any discs other than 5 inch/12 cm discs or 3 inch/8 cm discs which have been inserted into an 3 inch/8 cm disc adapter. (Note that attempting to replay such discs may result in damage or breakdown.)
- The BPM value measured by the CMX-3000 may differ from the BPM value recorded on a CD or from our DJ mixer, but this difference is a result of differences in the BPM value measurement method; not a result of a fault with the player.

Error Message Display

When the CMX-3000 CD player is unable to operate properly, an error code is displayed on the display panel. Check the error code displayed against the following table and take the recommended action to correct the error. If an error code other than any of the error codes listed in the table below is displayed or if the same error code is displayed even after corrective action has been taken, contact your nearest Pioneer Service Station or contact the store from which you purchased your player for assistance.

Error Code	Error Type	Description	Possible cause and recommended action
E-7201	TOC READ ERROR	Player unable to read TOC data.	Disc is cracked. → Recommended action: replace disc.
E-83 01 E-83 02 E-83 03	PLAYER ERROR	Player unable to play back currently inserted disc.	Disc is soiled or dirty. → Recommended action: clean disc. If other discs play normally, the problem is with the disc itself.
E-91 01	MECHANICAL TIME OUT	Mechanical operation has failed to complete within specified time interval.	Dust or some other form of foreign particles have found their way into disc insertion slot. → Recommended action: remove dust or other foreign particles.

Cleaning the Jog Dial

To clean the PLAYER wipe with a polishing or a soft, dry cloth. For stubborn dirt, moisten a soft cloth with a weak solution of neutral detergent (diluted in five to six parts water), wring the cloth well, and wipe away the dirt. Use a dry cloth to wipe the surface dry. Applying alcohol, paint thinner, benzene, insecticides, or other stringent substances to the jog dial may cause the markings or finishing of the dial to peel or become discolored, and the use of any such substances should accordingly be avoided.

<p>Should this product require service in the U.S.A. and you wish to locate the nearest Pioneer Authorized Independent Service Company, or if you wish to purchase replacement parts, operating instructions, service manuals, or accessories, please call the number shown below.</p> <p style="text-align: center;">800 – 872 – 4159</p> <p>Please do not ship your product to Pioneer without first calling the Customer Support Division at the above listed number for assistance.</p> <p>PIONEER ELECTRONICS (USA) INC. CUSTOMER SUPPORT DIVISION P.O. BOX 1760, LONG BEACH, CA 90801-1760, U.S.A.</p> <p>For warranty information please see the Limited Warranty sheet included with your product.</p>	<p>Should this product require service in Canada, please contact a Pioneer Canadian Authorized Dealer to locate the nearest Pioneer Authorized Service Company in Canada. Alternatively, please contact the Customer Service Department at the following address:</p> <p>Pioneer Electronics of Canada, Inc.</p> <p>300 Allstate Parkway Markham, ON L3R OP2 (905) 479-4411 1 (877) 283-5901</p> <p>For warranty information please see the Limited Warranty sheet included with your product.</p>
--	--

Published by Pioneer Corporation.
Copyright © 2001 Pioneer Corporation.
All rights reserved.