

■ Features

- Low forward voltage drop.
- Excellent high temperature stability.
- Fast switching capability.
- Suffix "G" indicates Halogen-free part, ex. CP10H100SG.
- Lead-free parts meet environmental standards of MIL-STD-19500 /228

■ Mechanical data

- Epoxy : UL94-V0 rated flame retardant.
- Case : Molded plastic, TO-277B.
- Lead : Solder plated, solderable per MIL-STD-750, Method 2026.
- Polarity: Indicated by cathode band.
- Mounting Position : Any.
- Weight : Approximated 0.093 grams.

■ Outline

TO-277B

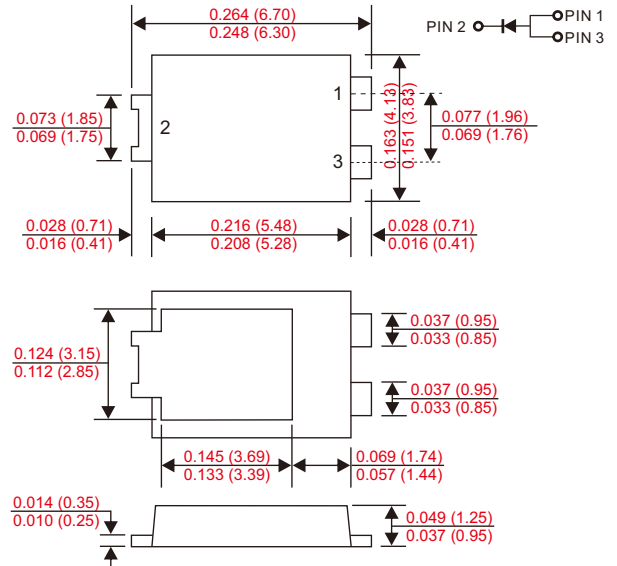

■ Maximum ratings and electrical characteristics

Rating at 25°C ambient temperature unless otherwise specified. Single phase, half wave, 60Hz, resistive or inductive load. For capacitive load, derate current by 20%.

Parameter	Conditions	Symbol	CP10H100SG	UNIT
Marking code			CP10H100S	
Peak repetitive reverse voltage		V_{RRM}		
Working peak reverse voltage		V_{RWM}	100	V
DC blocking voltage		V_{RM}		
RMS reverse voltage		$V_{R(RMS)}$	70	V
Forward rectified current		I_O	10	A
Forward surge current	8.3ms single half sine-wave superimposed on rate load (JEDEC method)	I_{FSM}	200	A
Thermal resistance	Junction to case	R_{BJC}	4	°C/W
Storage temperature		T_{STG}	-55 ~ +150	°C
Operating Junction temperature		T_J	-55 ~ +175	°C

Parameter	Conditions	Symbol	MIN.	TYP.	MAX.	UNIT
Forward voltage drop	$I_F = 5A, T_J = 25^\circ C$	V_F		600		mV
	$I_F = 10A, T_J = 25^\circ C$			680	750	
	$I_F = 5A, T_J = 125^\circ C$			497		
	$I_F = 10A, T_J = 125^\circ C$			571	640	
Reverse current	$V_R = V_{RRM}, T_J = 25^\circ C$	I_R		0.3	10	μA
	$V_R = V_{RRM}, T_J = 125^\circ C$			0.4	3	mA

■ Rating and characteristic curves

Fig. 1 - Instantaneous Forward Characteristics

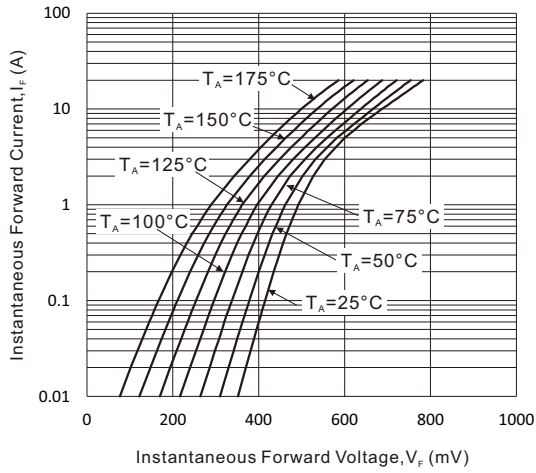

Fig. 2 - Reverse Characteristics

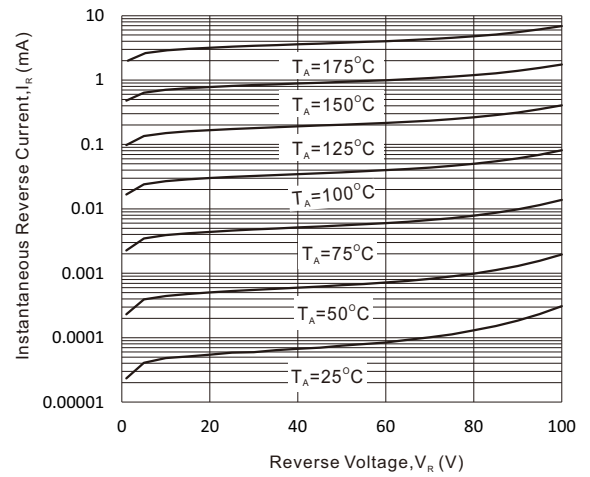

Fig. 3 - Forward Power Dissipation

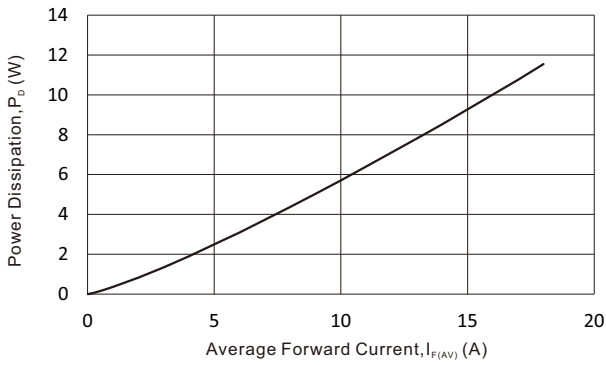

Fig. 4 - Forward Current Derating Curve

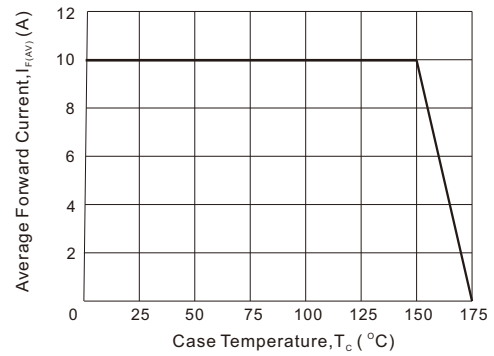
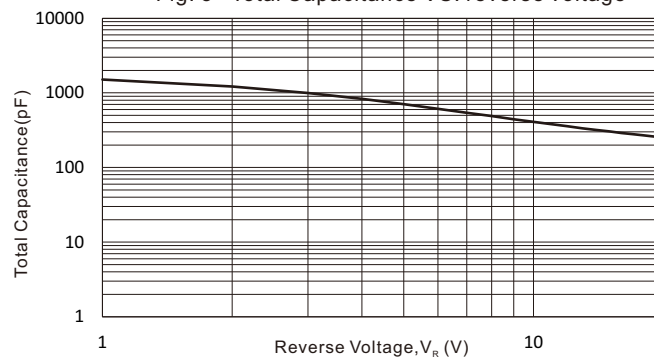
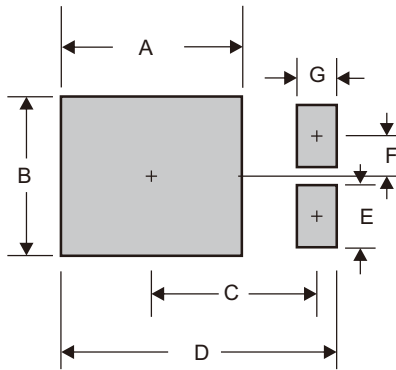

Fig. 5 - Total Capacitance VS. reverse voltage



■ TO-277B foot print



A	B	C	D	E	F	G
0.185 (4.70)	0.142 (3.60)	0.152 (3.87)	0.260 (6.60)	0.055 (1.40)	0.035 (0.90)	0.031 (0.80)

Dimensions in inches and (millimeters)

- CITC reserves the right to make changes to this document and its products and specifications at any time without notice.
- Customers should obtain and confirm the latest product information and specifications before final design, purchase or use.
- CITC makes no warranty, representation or guarantee regarding the suitability of its products for any particular purpose, nor does CITC assume any liability for application assistance or customer product design.
- CITC does not warrant or accept any liability with products which are purchased or used for any unintended or unauthorized application.
- No license is granted by implication or otherwise under any intellectual property rights of CITC.
- CITC products are not authorized for use as critical components in life support devices or systems without express written approval of CITC.