

Piezo Buzzer (DC)

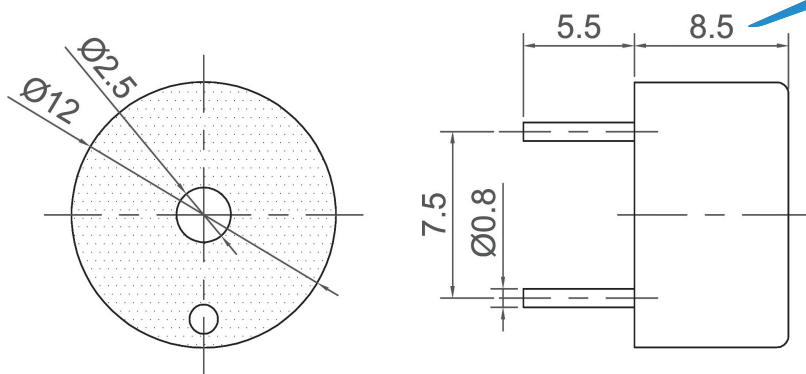

CPB1208

Canopus Part no.	Operating Voltage (VDC)	Rated Voltage (VDC)	Max Rated Current (mA)	Min Sound Output (dBA)	Resonant Frequency (Hz)	Tone Nature	Operating Temperature (°C)	Housing	Weight (g)
CPB1208HC50TP	2.5 ~ 15	12	8	85 at 10cm	4500 ± 500	Continuous	-20 ~ +70	PBT	4



CPB1407

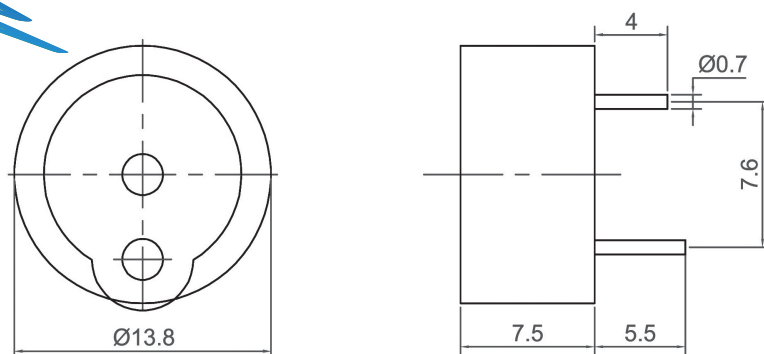

Canopus Part no.	Operating Voltage (VDC)	Rated Voltage (VDC)	Max Rated Current (mA)	Min Sound Output (dBA)	Resonant Frequency (Hz)	Tone Nature	Operating Temperature (°C)	Housing	Weight (g)
CPB1407EC40NP	3 ~ 16	5	7	75 at 10cm	4000 ± 500	Continuous	-20 ~ +60	Noryl	1
CPB1407HC40NP	3 ~ 16	12	7	85 at 10cm	4000 ± 500	Continuous	-20 ~ +60	Noryl	1

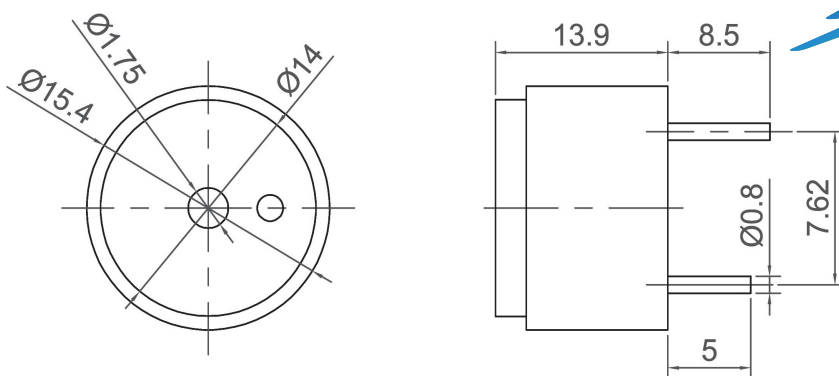

CPB1514

Canopus Part no.	Operating Voltage (VDC)	Rated Voltage (VDC)	Max Rated Current (mA)	Min Sound Output (dBA)	Resonant Frequency (Hz)	Tone Nature	Operating Temperature (°C)	Housing	Weight (g)
CPB1514EC40NP	1 ~ 12	5	15	83 at 30cm	4000 ± 500	Continuous	-20 ~ +60	Noryl	2.5
CPB1514HC40NP	1 ~ 18	12	20	85 at 10cm	4000 ± 500	Continuous	-20 ~ +60	Noryl	2.5

CANOPUS

Your Efficient Supplier
www.canopus.com.hk

TEL.: (852) 2806 2812

Fax: (852) 2652 2216