



Parameter	Rating	Units
Breakdown Voltage BV_{CEO}	30	V
Current Transfer Ratio (Min)	100	%
Saturation Voltage	0.3	V
Input Control Current	0.2	mA

Features

- Small 4 Pin SOP Package
- 100mA Continuous Load Rating
- 1500V_{rms} Input/Output Isolation
- Machine Insertable, Wave Solderable
- Surface Mount and Tape & Reel Version Available

Applications

- Loop Detect
- Ringing Detect
- Sensor Circuitry
- Instrumentation
- Multiplexers
- Data Acquisition
- I/O Subsystems
- Industrial Control

Description

CPC1001N is a unidirectional input optocoupler with a single transistor output. Current transfer ratios range from 100% to 800%.

Approvals

- UL Recognized Component: File # E76270
- EN/IEC 60950-1 Compliant
- CSA Certified Component: Certificate # 1172007

Ordering Information

Part #	Description
CPC1001N	4-Pin SOP (100/Tube)
CPC1001NTR	4-Pin SOP Surface Mount (2000/Reel)

Pin Configuration

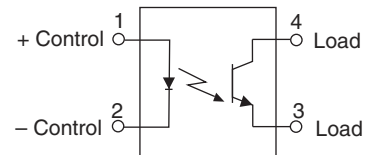

Absolute Maximum Ratings

Parameter	Ratings	Units
Input Power Dissipation ¹	150	mW
Input Control Current Peak (10ms)	5	mA
	1	A
Reverse Input Voltage	5	V
Phototransistor ²	150	mW
Isolation Voltage, Input to Output	1500	V _{rms}
Operational Temperature	-40 to +85	°C
Storage Temperature	-40 to +125	°C

¹ Derate Linearly 1.33 mW / °C

² Derate Linearly 2.00 mW / °C

Electrical absolute maximum ratings are at 25°C

Absolute Maximum Ratings are stress ratings. Stresses in excess of these ratings can cause permanent damage to the device. Functional operation of the device at conditions beyond those indicated in the operational sections of this data sheet is not implied.

Electrical Characteristics

Parameters	Conditions	Symbol	Min	Typ	Max	Units
Output Characteristics @ 25°C						
Phototransistor Blocking Voltage	I _{CEO} =10μA	BV _{CEO}	30	90	-	V _p
Phototransistor Output (Dark) Current	I _F =0mA, V _{CEO} =5V	I _{CEO}	-	9	500	nA
Saturation Voltage	I _F =1mA, I _C =1mA	V _{CE(sat)}	-	-	0.3	V
Current Transfer Ratio	I _F =0.2mA, V _{CE} =0.5V	CTR	100	330	800	%
Output Capacitance	V _{CEO} =25V, f=1MHz	C _{OUT}	-	6	-	pF
Input Characteristics @ 25°C						
Input Control Current	I _C =0.2mA, V _{CE} =0.5V	I _F	-	0.1	0.2	mA
Input Voltage Drop	I _F =5mA	V _F	0.9	1.2	1.4	V
Input Reverse Current	V _R =5V	I _R	-	-	10	μA
Common Characteristics @ 25°C						
Input to Output Capacitance	-	C _{I/O}	-	3	-	pF

Switching Characteristics @ 25°C

Characteristic	Symbol	Test Condition	Typ	Units
Turn-On Time	t _{ON}	I _F =2mA, V _{CC} =5V, R _L =1KΩ	1	μs
Turn-Off Time	t _{OFF}		30	

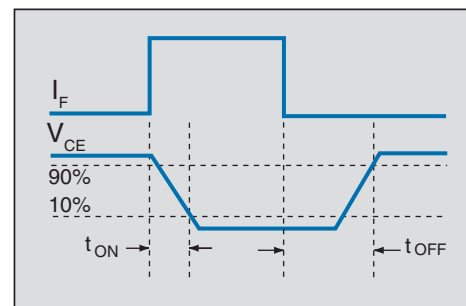
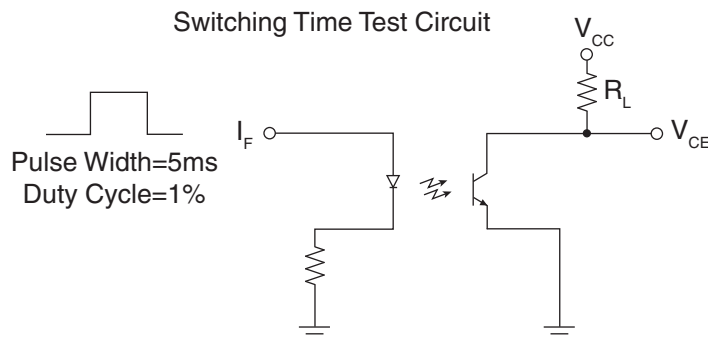

PERFORMANCE DATA*

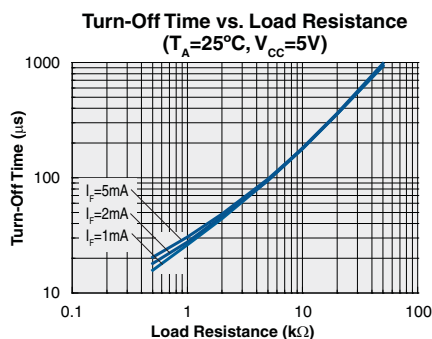
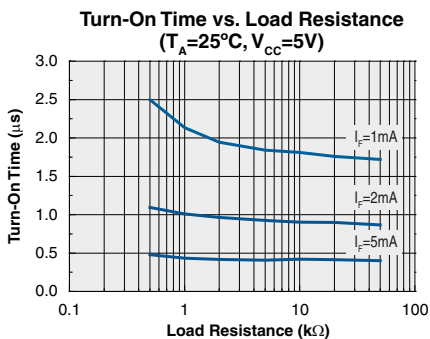
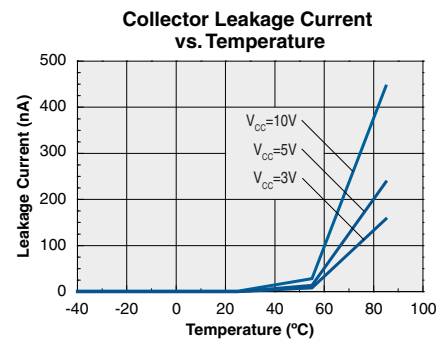
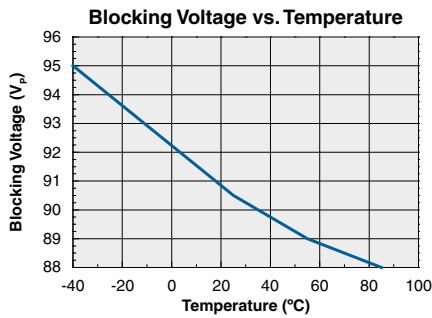
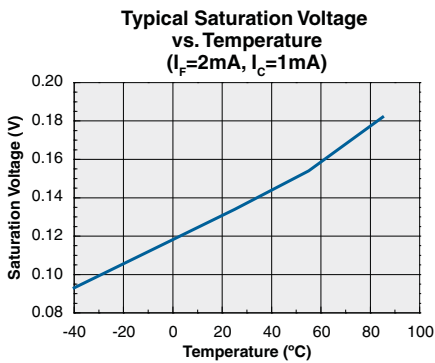
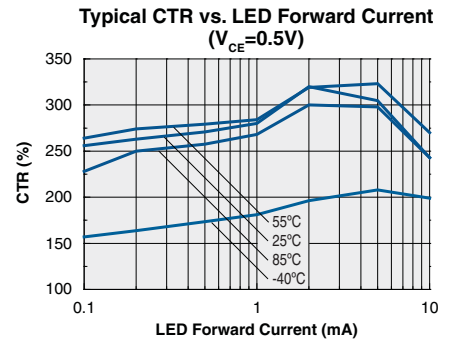
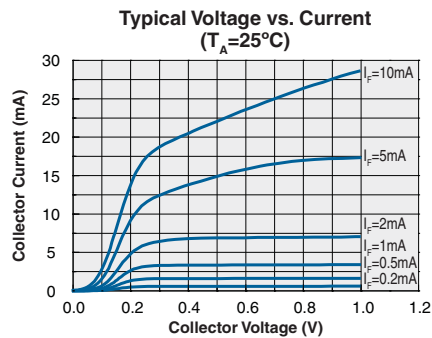
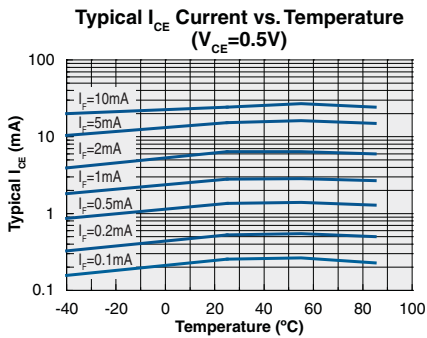
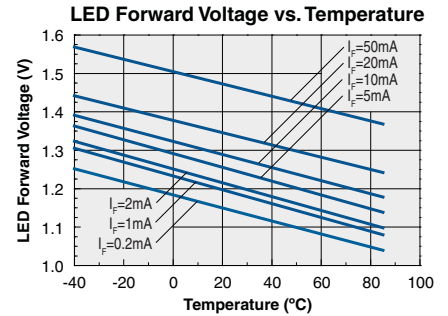
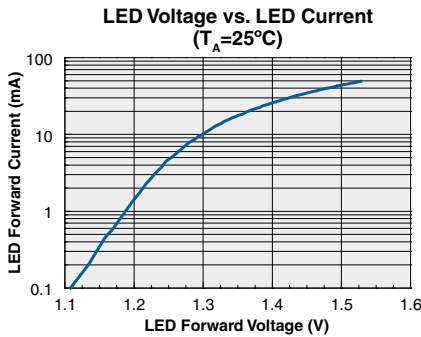
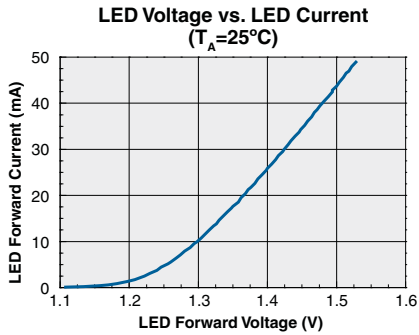

Refer to the Test Circuit on the previous page for these two graphs.

*The Performance data shown in the graphs above is typical of device performance. For guaranteed parameters not indicated in the written specifications, please contact our application department.

MANUFACTURING INFORMATION

Moisture Sensitivity

Clare has characterized the moisture reflow sensitivity of this package, and has determined that this component must be handled in accordance with IPC/JEDEC standard J-STD-033 moisture sensitivity level (MSL), level 3 classification.

Soldering Reflow Profile

For proper assembly, the component must be processed in accordance with the current revision of IPC/JEDEC standard J-STD-020. Failure to follow the recommended guidelines may cause permanent damage to the device resulting in impaired performance and/or a reduced lifetime expectancy.



Washing

Clare does not recommend ultrasonic cleaning or the use of chlorinated solvents.

MECHANICAL DIMENSIONS

4-Pin SOP Package

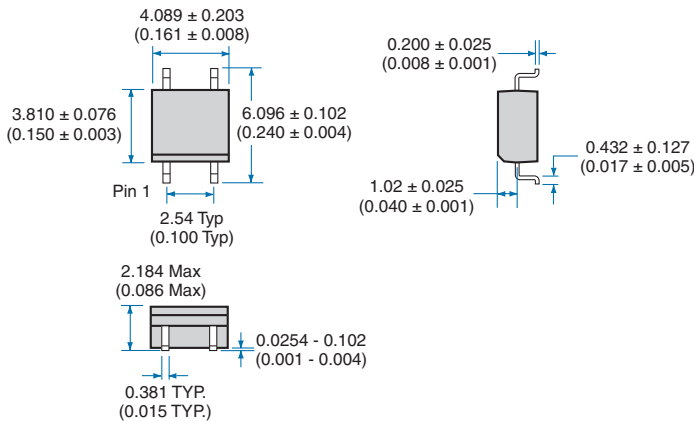

Recommended PCB Land Pattern

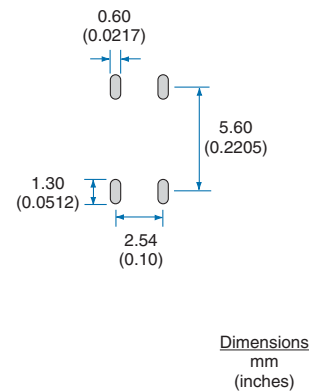

Tape and Reel Packaging for 4-Pin SOP Package

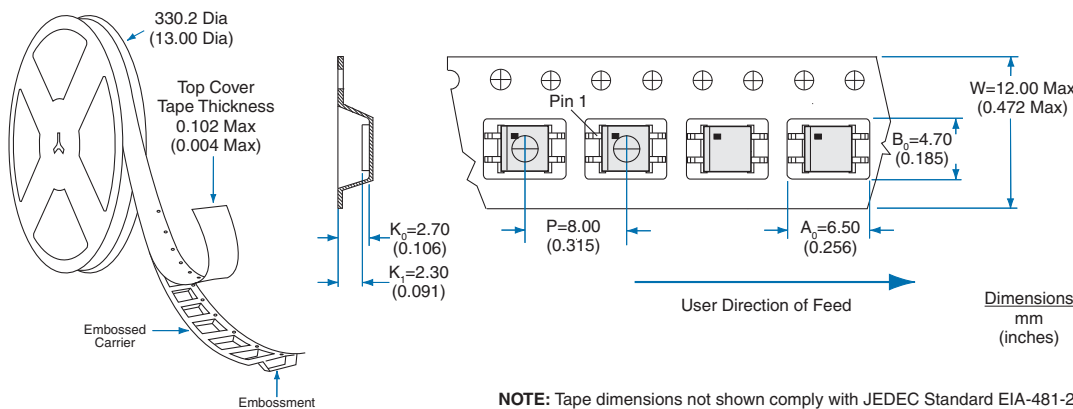

NOTE: Tape dimensions not shown comply with JEDEC Standard EIA-481-2

For additional information please visit our website at: www.clare.com

Clare, Inc. makes no representations or warranties with respect to the accuracy or completeness of the contents of this publication and reserves the right to make changes to specifications and product descriptions at any time without notice. Neither circuit patent licenses nor indemnity are expressed or implied. Except as set forth in Clare's Standard Terms and Conditions of Sale, Clare, Inc. assumes no liability whatsoever, and disclaims any express or implied warranty, relating to its products including, but not limited to, the implied warranty of merchantability, fitness for a particular purpose, or infringement of any intellectual property right.

The products described in this document are not designed, intended, authorized or warranted for use as components in systems intended for surgical implant into the body, or in other applications intended to support or sustain life, or where malfunction of Clare's product may result in direct physical harm, injury, or death to a person or severe property or environmental damage. Clare, Inc. reserves the right to discontinue or make changes to its products at any time without notice.