

Parameter	Rating	Units
Blocking Voltage	1000	V _P
Load Current		A _{DC}
With 5°C/W Heat Sink	2.45	
No Heat Sink	1.0	
On-resistance (Max)	1.25	Ω
R _{θJC}	0.3	°C/W

Features

- 100% Solid State
- Compact ISOPLUS-264 Power Package
- Low Thermal Resistance (0.3°C/W)
- 2.45A_{DC} Load Current with 5°C/W Heat Sink
- Electrically Non-conductive Thermal Pad for Heat Sink Applications
- Low Drive Power Requirements
- Arc-Free With No Snubbing Circuits
- 2500V_{rms} Input/Output Isolation
- No EMI/RFI Generation
- Machine Insertable, Wave Solderable

Applications

- Industrial Controls
- Motor Control
- Robotics
- Medical Equipment—Patient/Equipment Isolation
- Instrumentation
 - Multiplexers
 - Data Acquisition
 - Electronic Switching
 - I/O Subsystems
 - Meters (Watt-Hour, Water, Gas)
- Transportation Equipment
- Aerospace/Defense

Pin Configuration

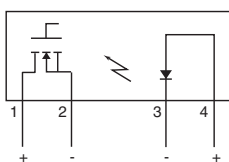

Description

Clare and IXYS have combined to bring OptoMOS® technology, reliability and compact size to a new family of High Power Solid State Relays. As part of this new family, the CPC1788 single-pole, normally open (1-Form-A) DC Solid State Relay employs optically coupled MOSFET technology to provide 2500V_{rms} of input to output isolation.

The output is constructed with an efficient MOSFET switch and photovoltaic die that uses Clare's patented OptoMOS architecture while the input GaAlAs infrared LED provides the optically coupled control. The combination of low on-resistance and high load current handling capability makes this relay suitable for a variety of high performance DC switching applications.

The unique ISOPLUS-264 package pioneered by IXYS allows solid state relays to achieve the highest load current and power ratings. This package features an IXYS unique process where the silicon chips are soft soldered onto the Direct Copper Bond (DCB) substrate instead of the usual copper leadframe. The DCB ceramic, the same substrate used in high power modules, not only provides 2500V_{rms} isolation but also very low thermal resistance (0.3°C/W).

Approvals

- UL 508 Recognized Component: File # E69938

Ordering Information

Part Number	Description
CPC1788J	ISOPLUS-264 (25 per tube)

Switching Characteristics of Normally Open (Form A) Devices

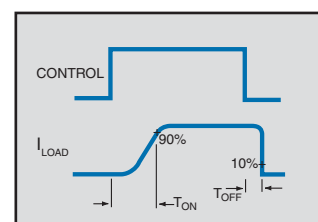

Absolute Maximum Ratings

Parameter	Ratings	Units
Blocking Voltage	1000	V _P
Reverse Input Voltage	5	V
Input Control Current	100	mA
Peak (10ms)	1	A _{DC}
Input Power Dissipation	150	mW
Isolation voltage, Input to Output	2500	V _{rms}
Operational Temperature	-40 to +85	°C
Storage Temperature	-40 to +125	°C

Absolute Maximum Ratings are stress ratings. Stresses in excess of these ratings can cause permanent damage to the device. Functional operation of the device at conditions beyond those indicated in the operational sections of this data sheet is not implied.

Electrical absolute maximum ratings are at 25°C

Electrical Characteristics

Parameter	Conditions	Symbol	Min	Typ	Max	Units
Output Characteristics $T_A=25^\circ\text{C}$						
Load Current ¹						
Peak	$t \leq 10\text{ms}$	I_L	-	-	12	A _P
Continuous	No Heat Sink				1	A _{DC}
Continuous	$T_C=25^\circ\text{C}$	10.3				
Continuous	$T_C=99^\circ\text{C}$	$I_{L(99)}$	1.2			
On-Resistance ²	$I_F=10\text{mA}, I_L=1\text{A}$	R_{ON}	-	1.0	1.25	Ω
Off-State Leakage Current	$V_L=1000V_P$	I_{LEAK}	-	-	1	μA
Switching Speeds						
Turn-On	$I_F=20\text{mA}, V_L=10\text{V}$	T_{ON}	-	2.85	20	ms
Turn-Off		T_{OFF}	-	0.11	5	
Output Capacitance	$V=25\text{V}, f=1\text{MHz}$	C_{OUT}	-	640	-	pF
Input Characteristics $T_A=25^\circ\text{C}$						
Input Control Current ³	$I_L=1\text{A}$	I_F	-	-	10	mA
Input Dropout Current	-	I_F	0.6	-	-	mA
Input Voltage Drop	$I_F=5\text{mA}$	V_F	0.9	1.2	1.4	V
Reverse Input Current	$V_R=5\text{V}$	I_R	-	-	10	μA
Common Characteristics $T_A=25^\circ\text{C}$						
Capacitance Input to Output	-	$C_{I/O}$	-	1	-	pF

¹ Higher load currents possible with proper heatsinking.

² Measurement taken within 1 second of on time.

³ For applications requiring high temperature operation (greater than 60°C) an LED drive current of 20mA is recommended.

Thermal Characteristics

Parameter	Conditions	Symbol	Min	Typ	Max	Units
Thermal Resistance (junction to case)	-	$R_{\theta JC}$	-	-	0.3	°C/W
Thermal Resistance (junction to ambient)	Free air	$R_{\theta JA}$	-	33	-	°C/W
Junction Temperature (operation)	-	T_J	-40	-	100	°C

Thermal Management

Device high current characterization was performed using Kunze heat sink KU 1-159, phase change thermal interface material KU-ALC 5, and transistor clip KU 4-499/1. This combination provided an approximate junction-to-ambient thermal resistance of 12.5°C/W.

Heat Sink Calculation

Higher load currents are possible by using lower thermal resistance heat sink combinations.

Heat Sink Rating

$$R_{\theta CA} = \frac{(T_J - T_A) I_{L(99)}^2}{I_L^2 \cdot P_{D(99)}} - R_{\theta JC}$$

T_J = Junction Temperature (°C), $T_J \leq 100^\circ\text{C}$ *

T_A = Ambient Temperature (°C)

$I_{L(99)}$ = Load Current with Case Temperature @ 99°C (A_{DC})

I_L = Desired Operating Load Current (A_{DC}), $I_L \leq I_{L(MAX)}$

$R_{\theta JC}$ = Thermal Resistance, Junction to Case (°C/W) = 0.3°C/W

$R_{\theta CA}$ = Thermal Resistance of Heat Sink & Thermal Interface Material, Case to Ambient (°C/W)

$P_{D(99)}$ = Maximum power dissipation with case temperature held at 99°C = 3.33W

* Elevated junction temperature reduces semiconductor lifetime.

PERFORMANCE DATA*

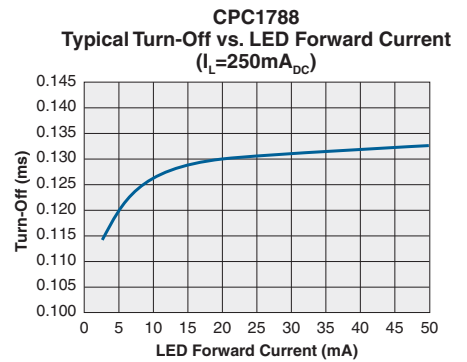
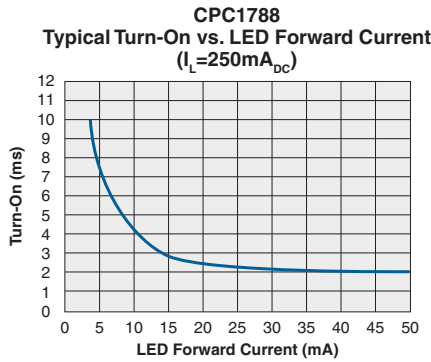
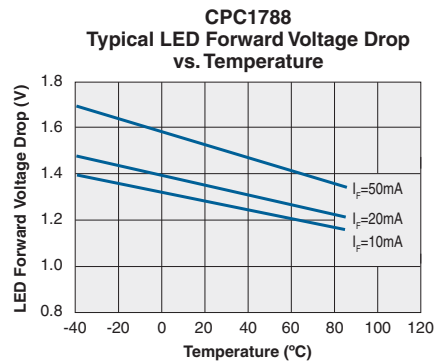
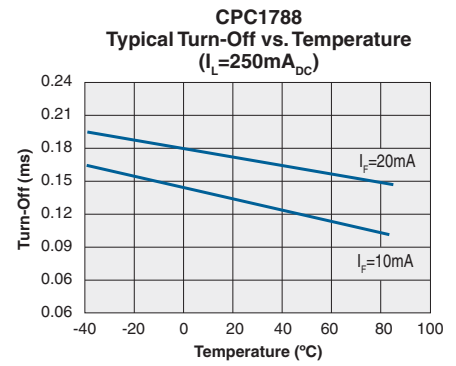
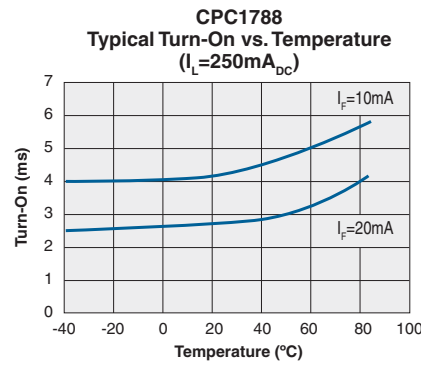
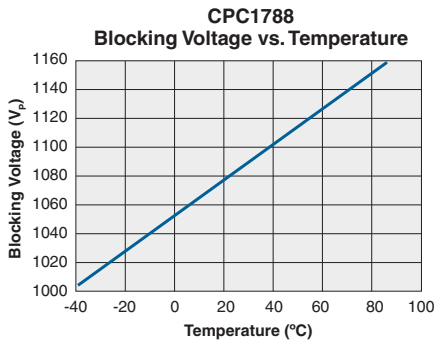
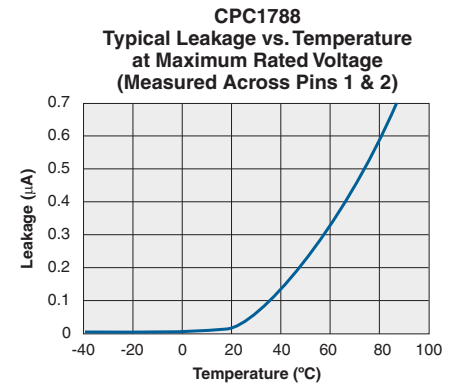
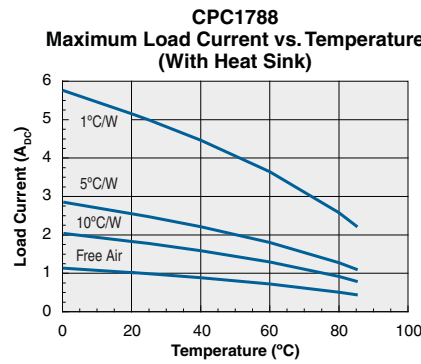
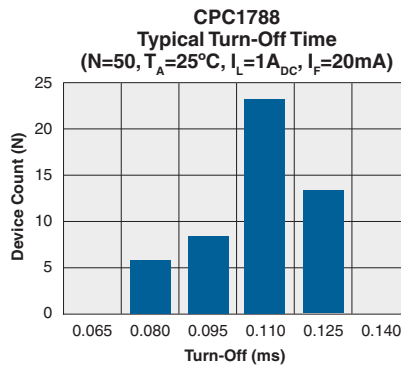
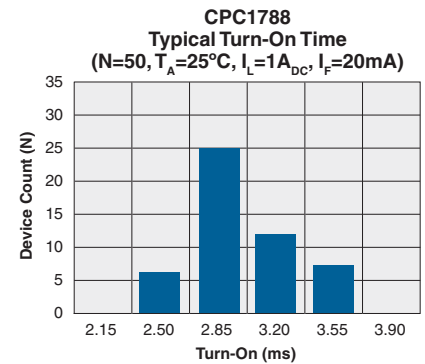
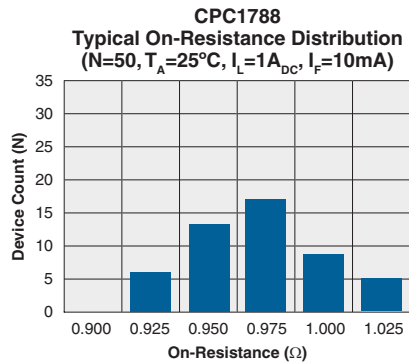
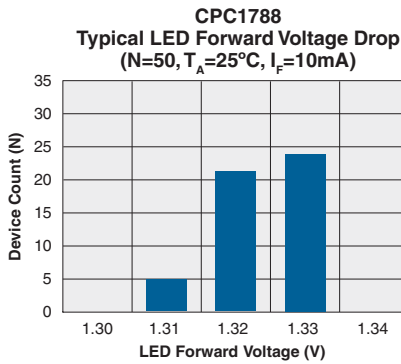

*The Performance data shown in the graphs above is typical of device performance. For guaranteed parameters not indicated in the written specifications, please contact our application department.

PERFORMANCE DATA*

CPC1788
Typical I_F for Switch Operation
vs. Temperature
($I_L=250\text{mA}_{DC}$)

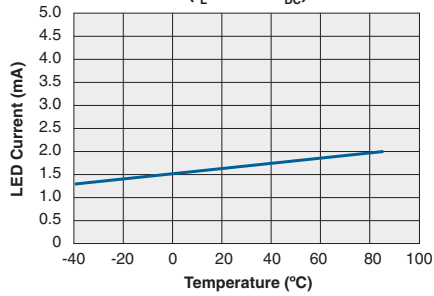

CPC1788
Typical On-Resistance vs. Temperature
($I_L=250\text{mA}_{DC}$)

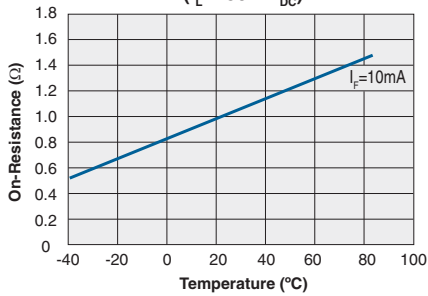

CPC1788
Typical On-Resistance vs. Temperature
($I_L=\text{Max Rated}$)

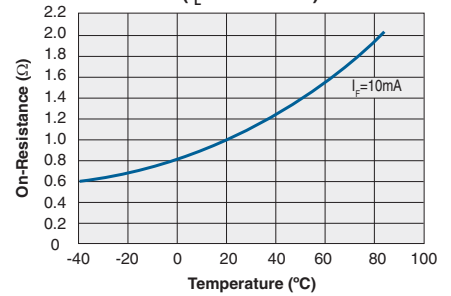

CPC1788
Typical Load Current vs. Load Voltage
($T_A=25^\circ\text{C}$, $I_F=10\text{mA}$)

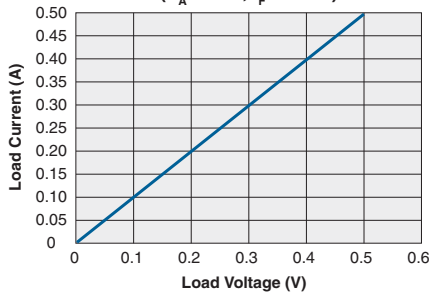

CPC1788
Energy Rating Curve
(Free Air, No Heat Sink)

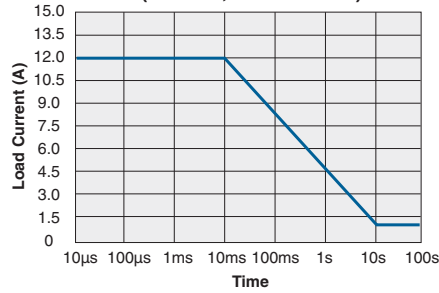

*The Performance data shown in the graphs above is typical of device performance. For guaranteed parameters not indicated in the written specifications, please contact our application department.

MANUFACTURING INFORMATION

Soldering

For proper assembly, the component must be processed in accordance with the current revision of IPC/JEDEC standard J-STD-020. Failure to follow the recommended guidelines may cause permanent damage to the device resulting in impaired performance and/or a reduced lifetime expectancy.

Washing

Clare does not recommend ultrasonic cleaning or the use of chlorinated solvents.



MECHANICAL DIMENSIONS:

ISOPLUS-264 Package

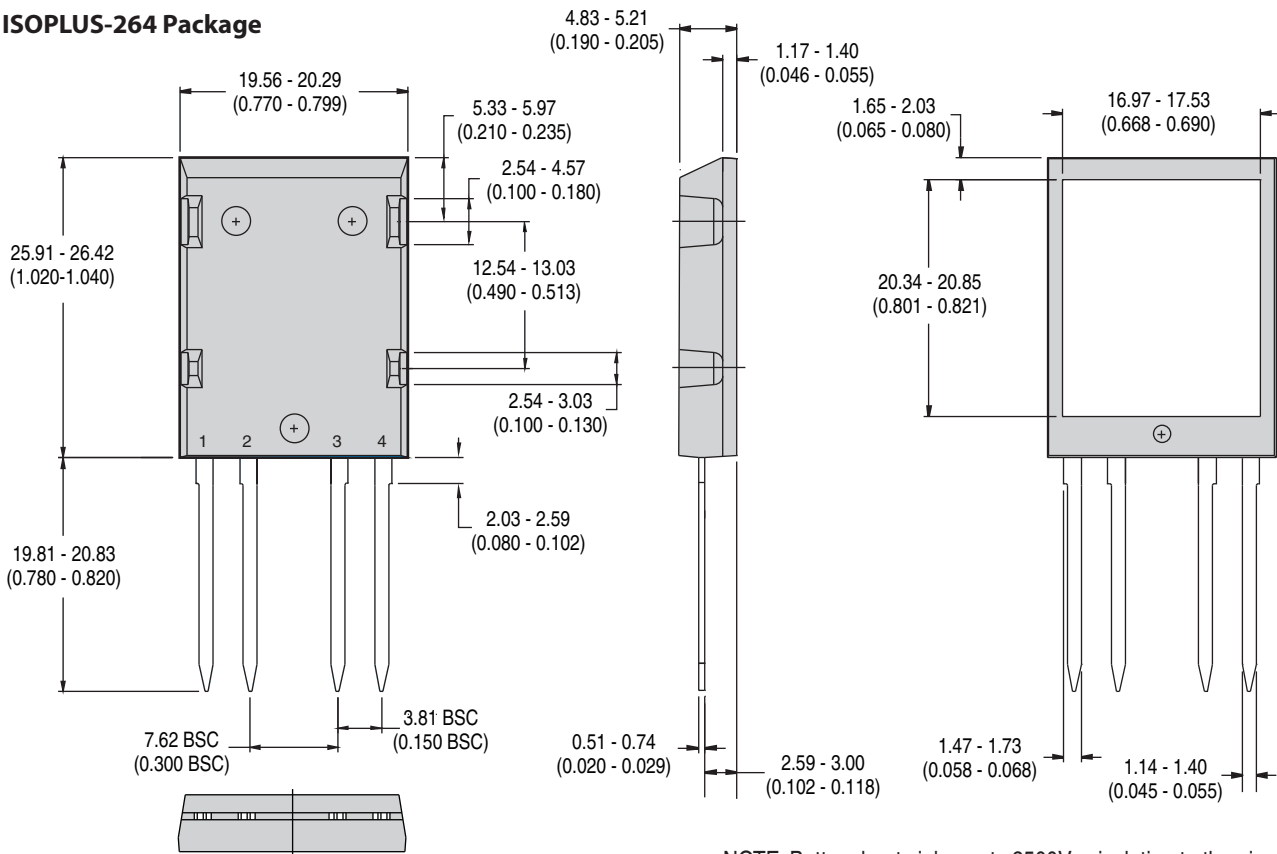

NOTE: Bottom heat sink meets 2500V_{rms} isolation to the pins.

DIMENSIONS
MIN - MAX mm
(MIN - MAX inches)

For additional information please visit our website at: www.clare.com

Clare, Inc. makes no representations or warranties with respect to the accuracy or completeness of the contents of this publication and reserves the right to make changes to specifications and product descriptions at any time without notice. Neither circuit patent licenses nor indemnity are expressed or implied. Except as set forth in Clare's Standard Terms and Conditions of Sale, Clare, Inc. assumes no liability whatsoever, and disclaims any express or implied warranty, relating to its products including, but not limited to, the implied warranty of merchantability, fitness for a particular purpose, or infringement of any intellectual property right.

The products described in this document are not designed, intended, authorized or warranted for use as components in systems intended for surgical implant into the body, or in other applications intended to support or sustain life, or where malfunction of Clare's product may result in direct physical harm, injury, or death to a person or severe property or environmental damage. Clare, Inc. reserves the right to discontinue or make changes to its products at any time without notice.