

# CPD-G520

## SERVICE MANUAL

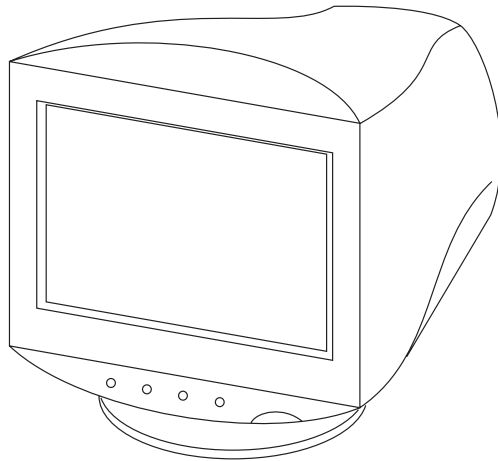

*US Model*  
*Canadian Model*  
*N. Hemisphere Model*  
*S. Hemisphere Model*  
*Equator Model*  
Chassis No. SCC-L33E-A

## CR1 CHASSIS

### SPECIFICATIONS

CRT	0.24 mm aperture grille pitch 21 inches measured diagonally 90-degree deflection FD Trinitron	Deflection frequency*	Horizontal: 30 to 130 kHz Vertical: 48 to 170 Hz
Viewable image size	Approx. 403.8 × 302.2 mm (w/h) (16 × 12 inches) 19.8" viewing image	AC input voltage/current Power consumption	100 to 240 V, 50 – 60 Hz, 2.0 – 1.0 A Approx. 135 W (with no USB devices connected)
Resolution		Dimensions	Approx. 497 × 502 × 485 mm (w/h/d) (19 <sup>5</sup> / <sub>8</sub> × 19 × 18 <sup>7</sup> / <sub>8</sub> inches)
Maximum	Horizontal: 2048 dots Vertical: 1536 lines	Mass	Approx. 30 kg (66 lb 2 oz)
Recommended	Horizontal: 1600 dots Vertical: 1200 lines	Plug and Play	DDC2B/DDC2Bi, GTF**
Input signal levels	Video signal Analog RGB: 0.700 Vp-p (positive), 75 Ω SYNC signal H/V separate or composite sync: TTL 2 kΩ, Polarity free Sync on Green: 0.3 Vp-p (negative)		* Recommended horizontal and vertical timing condition • Horizontal sync width duty should be more than 4.8% of total horizontal time or 0.8 μs, whichever is larger. • Horizontal blanking width should be more than 2.3 μsec. • Vertical blanking width should be more than 450 μsec. ** If the input signal is Generalized Timing Formula (GTF) compliant, the GTF feature of the monitor will automatically provide an optimal image for the screen.
Standard image area	Approx. 388 × 291 mm (w/h) (15 <sup>3</sup> / <sub>8</sub> × 11 <sup>1</sup> / <sub>2</sub> inches) or Approx. 364 × 291 mm (w/h) (14 <sup>3</sup> / <sub>8</sub> × 11 <sup>1</sup> / <sub>2</sub> inches)		Design and specifications are subject to change without notice.

TRINITRON® COLOR COMPUTER DISPLAY  
**SONY®**

## SAFETY CHECK-OUT

After correcting the original service problem, perform the following safety checks before releasing the set to the customer:

1. Check the area of your repair for unsoldered or poorly-soldered connections. Check the entire board surface for solder splashes and bridges.
2. Check the interboard wiring to ensure that no wires are “pinched” or contact high-wattage resistors.
3. Check that all control knobs, shields, covers, ground straps, and mounting hardware have been replaced. Be absolutely certain that you have replaced all the insulators.
4. Look for unauthorized replacement parts, particularly transistors, that were installed during a previous repair. Point them out to the customer and recommend their replacement.
5. Look for parts which, though functioning, show obvious signs of deterioration. Point them out to the customer and recommend their replacement.
6. Check the line cords for cracks and abrasion. Recommend the replacement of any such line cord to the customer.
7. Check the B+ and HV to see if they are specified values. Make sure your instruments are accurate; be suspicious of your HV meter if sets always have low HV.
8. Check the antenna terminals, metal trim, “metallized” knobs, screws, and all other exposed metal parts for AC Leakage. Check leakage as described below.

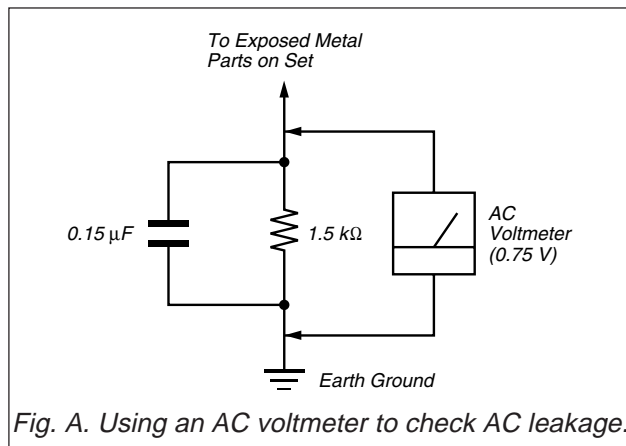

Fig. A. Using an AC voltmeter to check AC leakage.

## LEAKAGE TEST

The AC leakage from any exposed metal part to earth ground and from all exposed metal parts to any exposed metal part having a return to chassis, must not exceed 0.5 mA (500 microamperes).

Leakage current can be measured by any one of three methods.

1. A commercial leakage tester, such as the Simpson 229 or RCA WT-540A. Follow the manufacturers' instructions to use these instruments.
2. A battery-operated AC milliammeter. The Data Precision 245 digital multimeter is suitable for this job.
3. Measuring the voltage drop across a resistor by means of a VOM or battery-operated AC voltmeter. The “limit” indication is 0.75 V, so analog meters must have an accurate low-voltage scale. The Simpson 250 and Sanwa SH-63Trd are examples of a passive VOMs that are suitable. Nearly all battery operated digital multimeters that have a 2 V AC range are suitable. (See Fig. A)

**WARNING!!**

**NEVER TURN ON THE POWER IN A CONDITION IN WHICH THE DEGAUSS COIL HAS BEEN REMOVED.**

**SAFETY-RELATED COMPONENT WARNING!!**

**COMPONENTS IDENTIFIED BY SHADING AND MARK  $\triangle$  ON THE SCHEMATIC DIAGRAMS, EXPLODED VIEWS AND IN THE PARTS LIST ARE CRITICAL FOR SAFE OPERATION. REPLACE THESE COMPONENTS WITH SONY PARTS WHOSE PART NUMBERS APPEAR AS SHOWN IN THIS MANUAL OR IN SUPPLEMENTS PUBLISHED BY SONY. CIRCUIT ADJUSTMENTS THAT ARE CRITICAL FOR SAFE OPERATION ARE IDENTIFIED IN THIS MANUAL. FOLLOW THESE PROCEDURES WHENEVER CRITICAL COMPONENTS ARE REPLACED OR IMPROPER OPERATION IS SUSPECTED.**

**AVERTISSEMENT!!**

**NE JAMAIS METTRE SOUS TENSION QUAND LA BOBINE DE DEMAGNETISATION EST ENLEVÉE.**

**ATTENTION AUX COMPOSANTS RELATIFS À LA SÉCURITÉ!!**

**LES COMPOSANTS IDENTIFIÉS PAR UNE TRAME ET UNE MARQUE  $\triangle$  SONT CRITIQUES POUR LA SÉCURITÉ. NE LES REMPLACER QUE PAR UNE PIÈCE PORTANT LE NUMÉRO SPECIFIÉ. LES RÉGLAGES DE CIRCUIT DONT L'IMPORTANCE EST CRITIQUE POUR LA SÉCURITÉ DU FONCTIONNEMENT SONT IDENTIFIÉS DANS LE PRÉSENT MANUEL. SUIVRE CES PROCÉDURES LORS DE CHAQUE REMPLACEMENT DE COMPOSANTS CRITIQUES, OU LORSQU'UN MAUVAIS FONCTIONNEMENT EST SUSPECTÉ.**

## POWER SAVING FUNCTION

This monitor meets the power-saving guidelines set by VESA, ENERGY STAR, and NUTEK. If no signal is input to the monitor from your computer, the monitor will automatically reduce power consumption as shown below.

Power mode	Power consumption*	① (power) indicator
normal operation	≤ 135 W (CPD-G520) ≤ 130 W (CPD-G420)	green
active off** (deep sleep)***	≤ 3 W	orange
power off	Approx. 0 W	off

\* Figures reflect power consumption when no USB compatible peripherals are connected to the monitor.

\*\* When your computer enters power saving mode, the input signal is cut and NO SIGNAL appears on the screen before the monitor enters active off mode. After a few seconds, the monitor enters power saving mode.

\*\*\* "Deep sleep" is power saving mode defined by the Environmental Protection Agency.

## DIAGNOSIS

Failre	Power LED
+B failure	Amber (0.5 sec) → Off (0.5 sec)
Horizontal / Vertical Deflection failure, Thermal protector	Amber (1.5 sec) → Off (0.5 sec)
ABL protector	Amber (0.5 sec) → Off (1.5 sec)
HV failure	Amber (0.25 sec) → Off (0.25 sec) → Amber (0.25 sec) → Off (1.25 sec)
Aging / Self Test	Amber (0.5 sec) → Off (0.5 sec) → Green (0.5 sec) → Off (0.5 sec)
Out of scan range	Green (OSD indication)

Aging Mode (Video Aging) : During Power Save, press MENU button for longer than 2 second.

Self Test (OSD Color Bar) : During Power Save, push up Control button for longer than 2 second.

Reliability Check Mode : During Power Save, push down Control button for longer than 2 second.

**TIMING SPECIFICATION**

MODE AT PRODUCTION	MODE 1	MODE 2	MODE 3	MODE 4
RESOLUTION	640 X 480	1600 X 1200	1920 X 1440	1920 X 1440
CLOCK	25.175 MHz	229.500 MHz	341.000 MHz	297.000 MHz
— HORIZONTAL —				
H-FREQ	31.469 kHz	106.250 kHz	128.485 kHz	112.500 kHz
	usec	usec	usec	usec
H. TOTAL	31.778	9.412	7.783	8.889
H. BLK	6.356	2.440	2.152	2.424
H. FP	0.636	0.279	0.457	0.485
H. SYNC	3.813	0.837	0.622	0.754
H. BP	1.907	1.325	1.073	1.185
H. ACTIV	25.422	6.972	5.630	6.465
— VERTICAL —				
V. FREQ (HZ)	59.940 Hz	85.000 Hz	84.977 Hz	75.000 Hz
	lines	lines	lines	lines
V. TOTAL	525	1250	1512	1500
V. BLK	45	50	72	60
V. FP	10	1	1	1
V. SYNC	2	3	3	3
V. BP	33	46	68	56
V. ACTIV	480	1200	1440	1440
— SYNC —				
INT(G)	NO	NO	NO	NO
EXT (H/V) /POLARITY	YES N/N	YES P/P	YES P/P	YES N/P
EXT (CS) /POLARITY	NO	NO	NO	NO
INT/NON INT	NON INT	NON INT	NON INT	NON INT

2000.8.9 VER.

## TABLE OF CONTENTS

<i>Section</i>	<i>Title</i>	<i>Page</i>
<b>1. GENERAL</b>	.....	1-1
<b>2. DISASSEMBLY</b>		
2-1.	Cabinet Removal .....	2-1
2-2.	A1 Board (C Block) Removal .....	2-1
2-3.	A1 Board, US Board Removal .....	2-2
2-4.	Bezel Assembly, H1 Board, Magnetic Sensor Removal .....	2-3
2-5.	D Board Removal .....	2-3
2-6.	Service Position .....	2-4
2-7.	Picture Tube Removal .....	2-5
2-8.	Harness Location .....	2-6
<b>3. SAFETY RELATED ADJUSTMENT</b>	.....	3-1
<b>4. ADJUSTMENTS</b>	.....	4-1
<b>5. DIAGRAMS</b>		
5-1.	Block Diagrams .....	5-1
5-2.	Frame Schematic Diagram .....	5-7
5-3.	Circuit Boards Location .....	5-9
5-4.	Schematic Diagrams and Printed Wiring Boards .....	5-9
(1)	Schematic Diagram of A1 Board .....	5-11
(2)	Schematic Diagram of US Board (Only NH, SH, EQ models) .....	5-15
(3)	Schematic Diagram of DA Board .....	5-17
(4)	Schematic Diagram of N Board .....	5-19
(5)	Schematic Diagrams of D (a), (b), (c) Board .....	5-21
(6)	Schematic Diagram of H1 Board .....	5-29
(7)	Schematic Diagram of L2 Board .....	5-31
5-5.	Semiconductors .....	5-33
<b>6. EXPLODED VIEWS</b>		
6-1.	Chassis .....	6-1
6-2.	Picture Tube .....	6-2
6-3.	Packing Materials .....	6-3
<b>7. ELECTRICAL PARTS LIST</b>	.....	7-1

Note: Hand degauss must be used on stand-by or power-off condition.

This model has an automatic earth magnetism correction function by using an earth magnetism sensor and a LCC coil. When using a hand degauss while monitor (LCC coil) is being operated, it sometimes gets magnetized, and the system may not work properly as a result.

The operating instructions mentioned here are partial abstracts from the Operating Instruction Manual. The page numbers of the Operating Instruction Manual remain as in the manual.

## SECTION 1 GENERAL

### Precautions

#### Warning on power connections

- Use the supplied power cord. If you use a different power cord, be sure that it is compatible with your local power supply.

Example of plug types

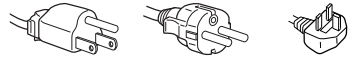

for 100 to 120 V AC for 200 to 240 V AC for 240 V AC only

- Before disconnecting the power cord, wait at least 30 seconds after turning off the power to allow the static electricity on the screen's surface to discharge.
- After the power is turned on, the screen is demagnetized (degaussed) for about a few seconds. This generates a strong magnetic field around the screen which may affect data stored on magnetic tapes and disks placed near the monitor. Be sure to keep magnetic recording equipment, tapes, and disks away from the monitor.

The equipment should be installed near an easily accessible outlet.

#### Installation

Do not install the monitor in the following places:

- on surfaces (rugs, blankets, etc.) or near materials (curtains, draperies, etc.) that may block the ventilation holes
- near heat sources such as radiators or air ducts, or in a place subject to direct sunlight
- in a place subject to severe temperature changes
- in a place subject to mechanical vibration or shock
- on an unstable surface
- near equipment which generates magnetism, such as a transformer or high voltage power lines
- near or on an electrically charged metal surface

#### Maintenance

- Clean the screen with a soft cloth. If you use a glass cleaning liquid, do not use any type of cleaner containing an anti-static solution or similar additive as this may scratch the screen's coating.
- Do not rub, touch, or tap the surface of the screen with sharp or abrasive items such as a ballpoint pen or screwdriver. This type of contact may result in a scratched picture tube.
- Clean the cabinet, panel and controls with a soft cloth lightly moistened with a mild detergent solution. Do not use any type of abrasive pad, scouring powder or solvent, such as alcohol or benzene.

#### Transportation

When you transport this monitor for repair or shipment, use the original carton and packing materials.

#### Use of the tilt-swivel

This monitor can be adjusted within the angles shown below. To find the center of the monitor's turning radius, align the center of the monitor's screen with the centering dot on the stand.

Hold the monitor at the bottom with both hands when you turn it horizontally or vertically. Be careful not to pinch your fingers at the back of the monitor when you tilt the monitor up vertically.

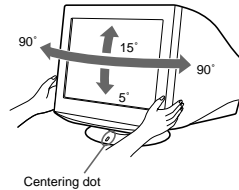

Centering dot

### Identifying parts and controls

See the pages in parentheses for further details.

#### Front

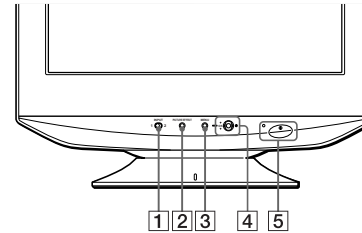

#### 1 INPUT (input) switch (page 9)

This switch selects the INPUT 1 (video input 1 connector: ①) or INPUT 2 (video input 2 connector: ②).

#### 2 PICTURE EFFECT button (page 11)

This button is used to change the preset picture effects' modes.

#### 3 MENU button (page 10)

This button is used to display or close the menu.

#### 4 Control button (OK, ↑/↓) (page 11)

This button is used to make adjustments to the monitor and call up the CONTRAST menu directly.

#### 5 ① (power) switch and indicator (pages 7, 18, 22)

This button turns the monitor on and off. The power indicator lights up in green when the monitor is turned on, and lights up in orange when the monitor is in power saving mode.

#### Rear

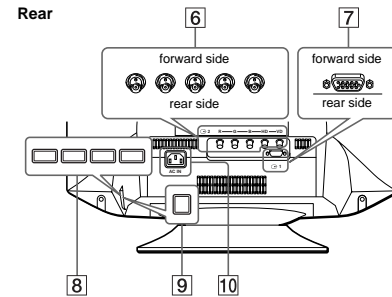

#### 6 Video input 2 connector (BNC) (page 6)

This connector inputs RGB video signals (0.700 Vp-p, positive) and sync signals.

#### 7 Video input 1 connector (HD15) (page 6)

This connector inputs RGB video signals (0.700 Vp-p, positive) and sync signals.



Pin No.	Signal	Pin No.	Signal
1	Red	9	DDC + 5V*
2	Green	10	Ground
	(Sync on Green)	11	ID (Ground)
3	Blue	12	Bi-Directional Data (SDA)*
4	ID (Ground)	13	H. Sync
5	DDC Ground*	14	V. Sync
6	Red Ground	15	Data Clock (SCL)*
7	Green Ground		
8	Blue Ground		

\* DDC (Display Data Channel) is a standard of VESA.

#### 8 USB (universal serial bus) downstream connectors (page 8)

Use these connectors to link USB peripheral devices to the monitor.

#### 9 USB (universal serial bus) upstream connector (page 8)

Use this connector to link the monitor to a USB compliant computer.

#### 10 AC IN connector (page 7)

This connector provides AC power to the monitor.

US

## Setup

Before using your monitor, check that the following accessories are included in your carton:

- Power cord (1)
- HD15 video signal cable (1)
- USB cable (1)
- Exclusive Power Mac G3/G4 adapter (1)
- Warranty card (1)
- Notes on cleaning the screen's surface (1)
- This instruction manual (1)

### Step 1: Connect your monitor to your computer

Turn off the monitor and computer before connecting.

#### Notes

- Do not touch the pins of the video signal cable connector as this might bend the pins.
- When connecting the video signal cable, check the alignment of the HD15 connector. Do not force the connector in the wrong way or the pins might bend.

#### ■ Connecting to an IBM PC/AT or compatible computer

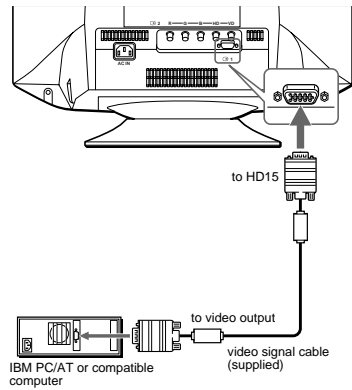

#### ■ Connecting to a Macintosh or compatible computer

Use the supplied exclusive Power Mac G3/G4 adapter.

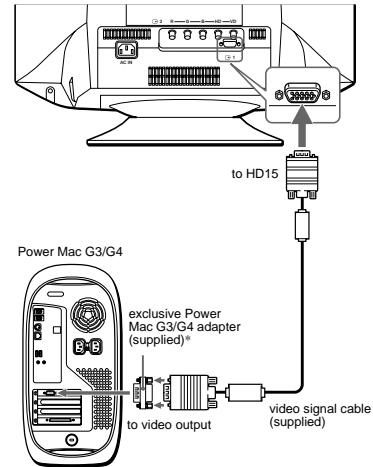

\* Connect the supplied adapter to the computer before connecting the cable. This adapter is compatible only with Power Mac G3/G4 computers that have 3 rows of pins. If you connect to the other version of Macintosh series computer that has 2 rows of pins, you will need a different adapter (not supplied).

#### ■ Connecting to the 5 BNC connectors

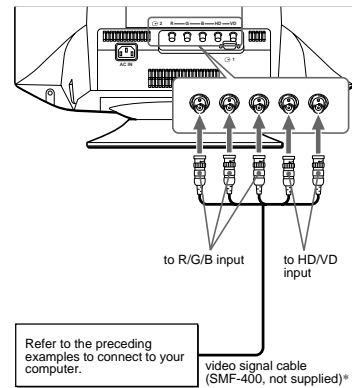

\* Connect the cables from left to right in the following order: Red-Green-Blue-HD-VD.

#### Note

Plug & Play (DDC) does not apply to the 5 BNC connectors. If you want to use Plug & Play, connect your computer to the connector using the supplied video signal cable.

### Step 2: Connect the power cord

With the monitor and computer switched off, first connect the power cord to the monitor, then connect it to a power outlet.

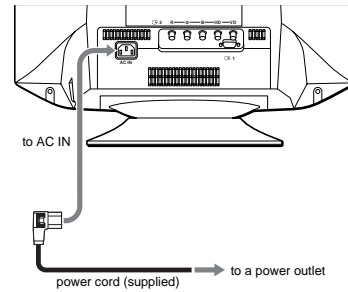

### Step 3: Turn on the monitor and computer

First turn on the monitor, then turn on the computer.

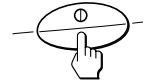

The installation of your monitor is complete. If necessary, use the monitor's controls to adjust the picture.

#### If no picture appears on your screen

- Check that the monitor is correctly connected to the computer.
- If NO SIGNAL appears on the screen, try changing the input signal (page 9), and confirm that your computer's graphics board is completely seated in the correct bus slot.
- If you are replacing an old monitor with this model and OUT OF SCAN RANGE appears on the screen, reconnect the old monitor. Then adjust the computer's graphics board so that the horizontal frequency is between 30 – 130 kHz (CPD-G520), 30 – 110 kHz (CPD-G420) and the vertical frequency is between 48 – 170 Hz.

For more information about the on-screen messages, see "Trouble symptoms and remedies" on page 20.

#### Setup on various OS (Operating System)

This monitor complies with the "DDC" Plug & Play standard and automatically detects all the monitor's information. No specific driver needs to be installed to the computer.

If you connect the monitor to your PC, and then boot your PC for the first time, the setup Wizard may be displayed on the screen. Click on "Next" several times according to the instructions from the Wizard until the Plug & Play Monitor is automatically selected so that you can use this monitor.

US

## Connecting Universal Serial Bus (USB) compliant peripherals

Your monitor has one upstream and four downstream USB connectors. They provide a fast and easy way to connect USB compliant peripheral devices (such as keyboards, mice, printers and scanners) to your computer using a standardized USB cable. To use your monitor as a hub for your peripheral devices, connect the USBs as illustrated below.

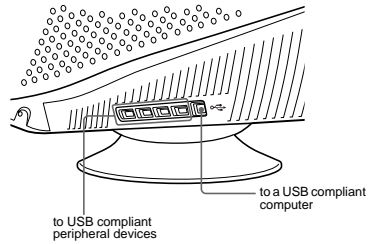

- 1 Turn on the monitor and computer.
- 2 Connect your computer to the square upstream connector using the supplied USB cable.

### For customers using Windows

If a message appears on your screen, follow the on-screen instructions and select Generic USB Hub as the default setting.

- 3 Connect your USB compliant peripheral devices to the rectangular downstream USB connectors.

### Notes

- Not all computers and/or operating systems support USB configurations. Check your computer's instruction manual to see if you can connect USB devices.
- In most cases, USB driver software needs to be installed on the host computer. Refer to the peripheral device's instruction manual for further details.
- The monitor functions as a USB hub as long as the monitor is either "on" or in power saving mode.
- If you connect a keyboard or mouse to the USB connectors and then boot your computer for the first time, the peripheral devices may not function. First connect the keyboard and mouse directly to the computer and set up the USB compliant devices. Then connect them to this monitor.

## Selecting the on-screen menu language (LANGUAGE)

English, French, German, Spanish, Italian, Dutch, Swedish, Russian and Japanese versions of the on-screen menus are available. The default setting is English.

- 1 Press the MENU button.  
The menu appears on the screen.

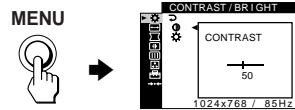

- 2 Move the control button up or down to highlight **OPTION** and press the control button.



- 3 Move the control button up or down to highlight **LANGUAGE** and press the control button.



- 4 Move the control button up or down until the desired language appears on the screen. Then press the control button to select the language.

Each time you move the control button up or down, the language can be selected appears cyclically.

- ENGLISH
- FRANÇAIS: French
- DEUTSCH: German
- ESPAÑOL: Spanish
- ITALIANO: Italian
- NEDERLANDS: Dutch
- SVENSKA: Swedish
- РУССКИЙ: Russian
- 日本語: Japanese

### To close the menu

Press the MENU button. If no buttons are pressed, the menu closes automatically after about 45 seconds.

### To reset to English

Select ENGLISH in step 4 above.

## Selecting the input signal

You can connect two computers to this monitor using the video input 1 (HD15) and video input 2 (BNC) connectors. To select one of the two computers, use the INPUT switch.

### Move the INPUT switch.

The selected connector appears on the screen for 3 seconds.

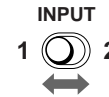

"INPUT 1": HD15 or "INPUT 2": BNC appears on the screen.

### Note

If no signal is input to the selected connector, NO SIGNAL appears on the screen. After a few seconds, the monitor enters the power saving mode. If this happens, switch to the other connector.



## Customizing Your Monitor

You can make numerous adjustments to your monitor using the on-screen menu.

### Navigating the menu

Press the MENU button to display the menu on the screen. See page 11 for more information on using the MENU and control buttons.

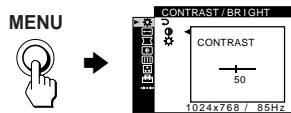

Use the control button to select one of the following menus.

#### 1 CONTRAST/BRIGHT (page 12)

Adjusts the contrast and brightness. You can also call up this menu directly by moving the control button up or down while there is no menu on the screen.

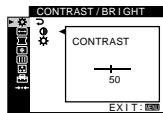

#### 2 SIZE/CENTER (page 12)

Adjusts the size or centering.

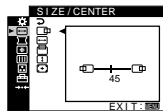

#### 3 GEOMETRY (page 13)

Adjusts the rotation and shape of the picture.

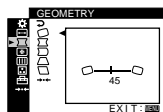

#### 4 CONVERGENCE (page 14)

Adjusts the picture's horizontal and vertical convergence.

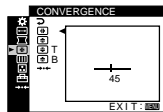

#### 5 SCREEN (page 14)

Adjusts the picture's quality. The options include:

- degaussing the screen (DEGAUSS)
- adjusting the moire cancellation (CANCEL MOIRE)
- adjusting the landing (LANDING)(CPD-G520 only)

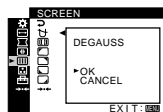

#### 6 COLOR (page 15)

Adjusts the picture's color temperature to match the monitor's colors to a printed picture's colors.

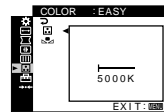

#### 7 OPTION (page 17)

Adjusts the monitor's options. The options include:

- locking the controls
- changing the on-screen menu's language
- changing the on-screen menu position
- changing the picture's color temperature setting mode

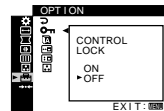

#### 8 RESET (page 18)

Resets the adjustments.

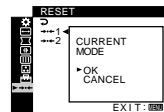

#### ■ Displaying the current input signal

When you press the MENU button to display the menu, the horizontal/vertical frequencies of the current input signal are displayed in the menu. If the signal matches one of this monitor's factory preset modes, the resolution is also displayed.

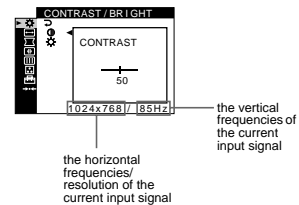

#### ■ Using the MENU and control buttons

##### 1 Display the menu.

Press the MENU button to display the menu on the screen.



##### 2 Select the menu you want to adjust.

Highlight the desired menu by moving the control button up or down. Then press the control button.

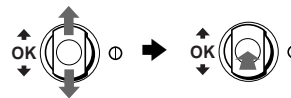

##### 3 Adjust the menu.

Move the control button up or down to make the adjustment and press the control button.

If you want to select another menu; move the control button up or down to select and press the control button to exit the menu.

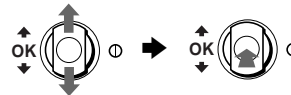

##### 4 Close the menu.

Press the MENU button. If no buttons are pressed, the menu closes automatically after about 45 seconds.



## Adjusting the picture quality (PICTURE EFFECT)

Press the PICTURE EFFECT button.

Each time you press the button, the three picture modes cyclically change as follows.







Select	For
PROFESSIONAL	accurate and consistent display color. Choose this for professional desktop publishing and graphic applications.
STANDARD	images with high contrast and brightness. Choose this mode for commonly used applications, such as spreadsheets, word processing, E-mail, or WEB surfing.
DYNAMIC	extremely vivid and photo-realistic images. Brighter than "STANDARD" mode, choose this for intense graphic applications such as games, DVD playback, or entertainment software.



US

## Adjusting the brightness and contrast (CONTRAST/BRIGHT)





These settings are stored in memory for the signals from the currently selected input connector.

- 1 Press the MENU button.**  
The menu appears on the screen.
- 2 Move the control button up or down to highlight . Then press the control button.**  
The CONTRAST/BRIGHT menu appears on the screen.
- 3 Move the control button up or down to highlight  or . Then press the control button.**
- 4 Move the control button up or down to adjust the contrast () or brightness (). Then press the control button.**

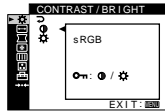
### If you are using the sRGB mode

If you selected the sRGB mode in the COLOR MODE () of the OPTION () menu, the following CONTRAST/BRIGHT menu appears on the screen.





You cannot adjust the contrast () or brightness () on this screen. If you want to adjust them, select a mode other than sRGB in the COLOR MODE () of the OPTION () menu.

For more information about using the sRGB mode, see "Adjusting the color of the picture (COLOR)" on page 15.



## Adjusting the centering of the picture (SIZE/CENTER)

This setting is stored in memory for the current input signal.

- 1 Press the MENU button.**  
The menu appears on the screen.
- 2 Move the control button up or down to highlight  and press the control button.**  
The SIZE/CENTER menu appears on the screen.
- 3 Move the control button up or down to select  for horizontal adjustment, or  for vertical adjustment. Then press the control button.**
- 4 Move the control button up or down to adjust the centering.**



## Adjusting the size of the picture (SIZE/CENTER)

This setting is stored in memory for the current input signal.

- 1 Press the MENU button.**  
The menu appears on the screen.
- 2 Move the control button up or down to highlight  and press the control button.**  
The SIZE/CENTER menu appears on the screen.
- 3 Move the control button up or down to select  for horizontal adjustment, or  for vertical adjustment. Then press the control button.**
- 4 Move the control button up or down to adjust the size.**

## Automatically sizing and centering the picture (AUTO)

You can easily adjust the picture to fill the screen by using the SIZE/CENTER menu.

- 1 Press the MENU button.**  
The menu appears on the screen.
- 2 Move the control button up or down to highlight  and press the control button.**  
The SIZE/CENTER menu appears on the screen.
- 3 Move the control button up or down to select  (AUTO). Then press the control button.**  
The adjustment window appears on the screen.
- 4 Move the control button up or down to select OK. Then press the control button.**  
The picture automatically fills the screen.





### Notes





- If you do not want to use the AUTO function, select CANCEL in step 4.
- This function is intended for use with a computer running Windows or similar graphic user interface software that provides a full-screen picture. It may not work properly if the background color is dark or if the input picture does not fill the screen to the edges (such as an MS-DOS prompt).
- The displayed image moves for a few seconds while this function is performed. This is not a malfunction.

## Adjusting the shape of the picture (GEOMETRY)

The GEOMETRY settings allow you to adjust the rotation and shape of the picture.

The  (rotation) setting is stored in memory for all input signals. All other settings are stored in memory for the current input signal.

- 1 Press the MENU button.**  
The menu appears on the screen.
- 2 Move the control button up or down to highlight  GEOMETRY and press the control button.**  
The GEOMETRY menu appears on the screen.
- 3 Move the control button up or down to select the desired adjustment item. Then press the control button.**  
The adjustment bar appears on the screen.
- 4 Move the control button up or down to make the adjustment. Then press the control button.**

Select	To
	rotate the picture
	expand or contract the picture sides
	shift the picture sides to the left or right
	adjust the picture width at the top of the screen
	shift the picture to the left or right at the top of the screen
*** <b>RESET</b>	reset all the GEOMETRY adjustments to the factory setting levels. Select OK.

For more information about using the RESET mode, see "Resetting the adjustments (RESET)" on page 18.





US

## Adjusting the convergence (CONVERGENCE)

The CONVERGENCE settings allow you to adjust the quality of the picture by controlling the convergence. The convergence refers to the alignment of the red, green, and blue color signals. If you see red or blue shadows around letters or lines, adjust the convergence.

These settings are stored in memory for all input signals.

- 1 **Press the MENU button.**  
The menu appears on the screen.
- 2 **Move the control button up or down to highlight  CONVERGENCE and press the control button.**  
The CONVERGENCE menu appears on the screen.
- 3 **Move the control button up or down to select the desired adjustment item. Then press the control button.**  
The adjustment bar appears on the screen.
- 4 **Move the control button up or down to make the adjustment. Then press the control button.**

Select	To
	horizontally shift red or blue shadows
	vertically shift red or blue shadows
 T	vertically shift red or blue shadows at the top of the screen
 B	vertically shift red or blue shadows at the bottom of the screen
*** RESET	reset all the CONVERGENCE adjustments to the factory setting levels. Select OK.

For more information about using the RESET mode, see "Resetting the adjustments (RESET)" on page 18.







## Adjusting the picture quality (SCREEN)

The SCREEN settings allow you to degauss (demagnetize) the monitor manually and adjust the picture quality by controlling the moire and landing.

- If the color is not uniform or picture is fuzzy, degauss the monitor (DEGAUSS).
  - If elliptical or wavy patterns appear on the screen, cancel the moire (CANCEL MOIRE).
  - If the color is irregular at the corners of the screen, adjust the landing (LANDING) (CPD-G520 only).
- The monitor is automatically demagnetized (degaussed) when the power is turned on.  
The screen is degaussed for about 2 seconds. If a second degauss cycle is needed, allow a minimum interval of 20 minutes for the best result.

The CANCEL MOIRE setting is stored in memory for the current input signal. All other settings are stored in memory for all input signals.

- 1 **Press the MENU button.**  
The menu appears on the screen.
- 2 **Move the control button up or down to highlight  SCREEN and press the control button.**  
The SCREEN menu appears on the screen.
- 3 **Move the control button up or down to select the desired adjustment item. Then press the control button.**  
The adjustment bar appears on the screen.
- 4 **Move the control button up or down to make the adjustment. Then press the control button.**

Select	To
 DEGAUSS	degauss the monitor. To degauss the monitor manually, select OK.
 CANCEL MOIRE	adjust the degree of moire cancellation until the moire* is at a minimum
 LANDING**	reduce any color irregularities in the screen's top left corner to a minimum
 LANDING**	reduce any color irregularities in the screen's top right corner to a minimum
 LANDING**	reduce any color irregularities in the screen's bottom left corner to a minimum
 LANDING**	reduce any color irregularities in the screen's bottom right corner to a minimum
*** RESET**	reset all the SCREEN adjustments to the factory setting levels. Select OK.

\* Moire is a type of natural interference which produces soft, wavy lines on your screen. It may appear due to interference between the pattern of the picture on the screen and the phosphor pitch pattern of the monitor.

\*\* The LANDING and RESET functions are for CPD-G520 only.

Example of moire



### Note



The picture may become fuzzy when the CANCEL MOIRE function is activated.



## Adjusting the color of the picture (COLOR)

The COLOR settings allow you to adjust the picture's color temperature by changing the color level of the white color field. Colors appear reddish if the temperature is low, and bluish if the temperature is high. This adjustment is useful for matching the monitor's color to a printed picture's colors. You can set the color temperature for each of the video input connectors.

### ■ Select the COLOR mode

There are 4 types of adjustment modes, EASY, PRESET, EXPERT, and sRGB. The default setting is EASY which can be adjustable from 5000K to 11000K.

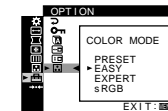

If you want to set another mode (other than EASY), select the desired mode in the OPTION () menu. Then adjust the selected mode in each COLOR () menu.

- 1 **Press the MENU button.**  
The menu appears on the screen.
- 2 **Move the control button up or down to highlight  OPTION and press the control button.**  
The OPTION menu appears on the screen.
- 3 **Move the control button up or down to highlight  COLOR MODE. Then press the control button.**
- 4 **Move the control button up or down to select the COLOR mode.**



US

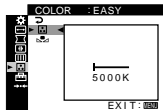

### ■ EASY mode

- 1 Press the MENU button.  
The menu appears on the screen.
- 2 Move the control button up or down to highlight  COLOR and press the control button.  
The COLOR menu appears on the screen.
- 3 Move the control button up or down to highlight  EASY. Then press the control button.  
The adjustment bar appears.



- 4 Move the control button up or down to fine tune the color temperature.  
The new color temperature setting you fine tuned between 5000K to 11000K is stored in memory.

### ■ PRESET mode

- 1 Press the MENU button.  
The menu appears on the screen.
- 2 Move the control button up or down to highlight  COLOR and press the control button.  
The COLOR menu appears on the screen.
- 3 Move the control button up or down to highlight  PRESET. Then press the control button.  
The adjustment bar appears.

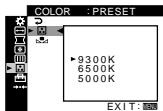



- 4 Move the control button up or down to select the desired temperature.  
The preset color temperatures are 5000K, 6500K, and 9300K. Since the default setting is 9300K, the whites will change from a bluish hue to a reddish hue as the temperature is lowered to 6500K and 5000K.

### ■ EXPERT mode

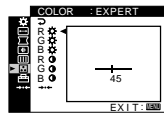

You can make additional adjustments to the color in greater detail by selecting the EXPERT mode.

- 1 Press the MENU button.  
The menu appears on the screen.
- 2 Move the control button up or down to highlight  COLOR and press the control button.  
The COLOR menu appears on the screen.



- 3 Move the control button up or down to adjust the R (red), G (green), and B (blue) component of input signal for each of GAIN (●) and BIAS (○). Then press the control button.  
If you want to reset the EXPERT adjustments, select  (RESET) in COLOR menu. Then select OK in the RESET window.

### ■ sRGB mode

The sRGB color setting is an industry standard color space protocol designed to correlate the displayed and printed colors of sRGB compliant computer products. To adjust the colors to the sRGB profile, simply select the sRGB mode in the COLOR MODE (  ) menu of the OPTION (  ) menu. However, in order to display the sRGB colors correctly ( $\gamma = 2.2$ , 6500K), you must set the PICTURE EFFECT mode to PROFESSIONAL (page 11) and your computer to the sRGB profile. If you select this mode, you cannot operate the CONTRAST/BRIGHT menu adjustments.

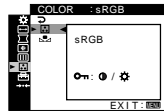



#### Note

Your computer and other connected products (such as a printer), must be sRGB compliant.

### Restoring the color from the EASY, PRESET, or sRGB modes (IMAGE RESTORATION)

The colors of most display monitors tend to gradually change brilliance over several years of service. The IMAGE RESTORATION feature found in the EASY, PRESET, and sRGB modes allows you to restore the color to the original factory quality levels. The explanation below explains how to restore the monitor's color from the EASY mode for example.

First, select the EASY, PRESET, or sRGB mode in the OPTION menu (page 15).

- 1 Press the MENU button.  
The menu appears on the screen.
- 2 Move the control button up or down to highlight  COLOR and press the control button.  
The COLOR menu appears on the screen.
- 3 Move the control button up or down to highlight  IMAGE RESTORATION. Then press the control button.
- 4 Move the control button up or down to select OK. Then press the control button.

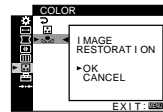

The picture disappears while the color is being restored (about 2 seconds). After the color is restored, the picture reappears on the screen again.

#### Notes

- Before using this feature, the monitor must be in normal operation mode (green power indicator on) for at least 30 minutes. If the monitor goes into power saving mode, you must return the monitor to normal operation mode and wait for 30 minutes for the monitor to be ready. You may need to adjust your computer's power saving settings to keep the monitor in normal operation mode for the full 30 minutes. If the monitor is not ready, the following message will appear.

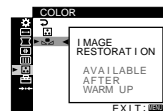





- The monitor may gradually lose its ability to perform this function due to the natural aging of the picture tube.

## Additional settings (OPTION)

You can lock the controls, change the on-screen language, change the menu position, and set the COLOR mode.

- 1 Press the MENU button.  
The menu appears on the screen.
- 2 Move the control button up or down to highlight  OPTION and press the control button.  
The OPTION menu appears on the screen.
- 3 Move the control button up or down to select the desired adjustment item.  
Adjust the selected item according to the following instructions.

### ■ Locking the controls (CONTROL LOCK)

You can protect the adjustment data by locking the controls. Move the control button up or down to highlight  (CONTROL LOCK) and press the control button. Then move the control button up or down to select ON and press the control button. Only the  (power) switch, MENU button, INPUT switch, and  (CONTROL LOCK) of the  OPTION menu will operate. If any other items are selected, the  mark appears on the screen.

US

#### To cancel the control lock



Repeat the procedure above and set  (CONTROL LOCK) to OFF.

### ■ Changing the on-screen language (LANGUAGE)

See page 8.

### ■ Changing the menu's position (OSD POSITION)

Change the menu's position if it is blocking an image on the screen.

Move the control button up or down to select  (OSD POSITION) for horizontal adjustment, or  (OSD POSITION) for vertical adjustment and press the control button. Then move the control button up or down to shift the on-screen menu.

### ■ Setting the COLOR mode

See page 15.

## Resetting the adjustments (RESET)

This monitor has the following 2 reset methods.

### ■ Resetting all the adjustment data for the current input signal

- 1 Press the **MENU** button.  
The menu appears on the screen.
- 2 Move the control button up or down to highlight **→→→ RESET** and press the control button.
- 3 Move the control button up or down to select **→→→1** and press the control button.
- 4 Move the control button up or down to select **OK** and press the control button.

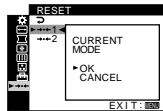

Note that the following items are not reset by this method:

- on-screen menu language (page 8)
- color mode setting in the OPTION menu (EASY, PRESET, EXPERT, sRGB) (page 15)
- color temperature setting in the PRESET mode (5000K, 6500K, 9300K) (page 16)
- on-screen menu position (page 17)

### ■ Resetting all of the adjustment data for all input signals

Select **→→→2** in step 3 above.

#### Note

The RESET function does not function when **CONTROL LOCK** is set to ON.

## Technical Features

### Preset and user modes

When the monitor receives an input signal, it automatically matches the signal to one of the factory preset modes stored in the monitor's memory to provide a high quality picture at the center of the screen. (See Appendix for a list of the factory preset modes.) For input signals that do not match one of this monitor ensures that a clear picture appears on the screen for any timing in the monitor's frequency range (horizontal: 30 – 130 kHz (CPD-G520), 30 – 110 kHz (CPD-G420), vertical: 48 – 170 Hz). If the picture is adjusted, the adjustment data is stored as a user mode and automatically recalled whenever the same input signal is received.

#### Note for Windows users

For Windows users, check your graphics board manual or the utility program which comes with your graphics board and select the highest available refresh rate to maximize monitor performance.

### Power saving function

This monitor meets the power-saving guidelines set by VESA, ENERGY STAR, and NUTEK. If no signal is input to the monitor from your computer, the monitor will automatically reduce power consumption as shown below.

Power mode	Power consumption*	① (power) indicator
normal operation	≤ 135 W (CPD-G520) ≤ 130 W (CPD-G420)	green
active off**	≤ 3 W	orange
(deep sleep)***		
power off	Approx. 0 W	off

\* Figures reflect power consumption when no USB compatible peripherals are connected to the monitor.

\*\* When your computer enters power saving mode, the input signal is cut and NO SIGNAL appears on the screen before the monitor enters active off mode. After a few seconds, the monitor enters power saving mode.

\*\*\* "Deep sleep" is power saving mode defined by the Environmental Protection Agency.

## Troubleshooting

Before contacting technical support, refer to this section.

### If thin lines appear on your screen (damper wires)

The visible lines on your screen especially when the background screen color is light (usually white), are normal for the Trinitron monitor. This is not a malfunction. These are shadows from the damper wires used to stabilize the aperture grille. The aperture grille is the essential element that makes a Trinitron picture tube unique by allowing more light to reach the screen, resulting in a brighter, more detailed picture.

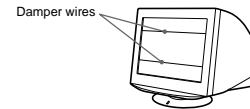

### On-screen messages

If there is something wrong with the input signal, one of the following messages appears on the screen.

#### If NO SIGNAL appears on section ①

This indicates that no signal is input from the selected connector.

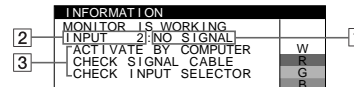

#### ② The selected connector

This message shows the currently selected connector (INPUT 1 or INPUT 2).

#### ③ The remedies

The following messages appear on the screen.

- If **ACTIVATE BY COMPUTER** appears on the screen, try pressing any key on the computer or moving the mouse, and confirm that your computer's graphics board is completely seated in the correct bus slot.
- If **CHECK SIGNAL CABLE** appears on the screen, check that the monitor is correctly connected to the computer (page 6).
- If **CHECK INPUT SELECTOR** appears on the screen, try changing the input signal (page 9).

#### If OUT OF SCAN RANGE appears on line ①

This indicates that the input signal is not supported by the monitor's specifications.

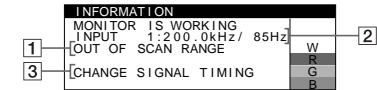

#### ② The selected connector and the frequencies of the current input signal

This message shows the currently selected connector (INPUT 1 or INPUT 2). If the monitor recognizes the frequencies of the current input signal, the horizontal and vertical frequencies are also displayed.

#### ③ The remedies

**CHANGE SIGNAL TIMING** appears on the screen. If you are replacing an old monitor with this monitor, reconnect the old monitor. Then adjust the computer's graphics board so that the horizontal frequency is between 30 – 130 kHz (CPD-G520), 30 – 110 kHz (CPD-G420), and the vertical frequency is between 48 – 170 Hz.

For more information, see "Trouble symptoms and remedies" on page 20.

US

### Displaying this monitor's name, serial number, and date of manufacture.

While the monitor is receiving a video signal, press and hold the **MENU** button for more than 5 seconds to display this monitor's information box.



If the problem persists, call your authorized Sony dealer and give the following information.

- Model name: CPD-G520 or CPD-G420
- Serial number
- Name and specifications of your computer and graphics board.

## Trouble symptoms and remedies

If the problem is caused by the connected computer or other equipment, please refer to the connected equipment's instruction manual. Use the self-diagnosis function (page 22) if the following recommendations do not resolve the problem.

Symptom	Check these items
<b>No picture</b>	
If the (power) indicator is not lit	<ul style="list-style-type: none"> <li>Check that the power cord is properly connected.</li> <li>Check that the (power) switch is in the "on" position.</li> </ul>
If the NO SIGNAL message appears on the screen, or if the (power) indicator is orange	<ul style="list-style-type: none"> <li>Check that the video signal cable is properly connected and all plugs are firmly seated in their sockets (page 6).</li> <li>Check that the INPUT switch setting is correct (page 9).</li> <li>Check that the video input connector's pins are not bent or pushed in.</li> </ul> <p>■ <b>Problems caused by the connected computer or other equipment</b></p> <ul style="list-style-type: none"> <li>The computer is in power saving mode. Try pressing any key on the keyboard or moving the mouse.</li> <li>Check that the computer's power is "on."</li> <li>Check that the graphic board is completely seated in the proper bus slot.</li> </ul>
If the OUT OF SCAN RANGE message appears on the screen	<p>■ <b>Problems caused by the connected computer or other equipment</b></p> <ul style="list-style-type: none"> <li>Check that the video frequency range is within that specified for the monitor. If you replaced an old monitor with this monitor, reconnect the old monitor and adjust the frequency range to the following. Horizontal: 30 – 130 kHz (CPD-G520), 30 – 110 kHz (CPD-G420) Vertical: 48 – 170 Hz</li> </ul>
If no message is displayed and the (power) indicator is green or flashing orange	<ul style="list-style-type: none"> <li>Use the Self-diagnosis function (page 22).</li> </ul>
If using a Macintosh system	<ul style="list-style-type: none"> <li>When connecting to a Power Mac G3/G4 that has 3 rows of pins, check that the supplied exclusive Power Mac G3/G4 adapter and the video signal cable are properly connected (page 6).</li> <li>If you connect to the other version of Macintosh series computer that has 2 rows of pins, you will need a different adapter (not supplied).</li> </ul>
<b>Picture flickers, bounces, oscillates, or is scrambled</b>	<ul style="list-style-type: none"> <li>Isolate and eliminate any potential sources of electric or magnetic fields such as other monitors, laser printers, fluorescent lighting, televisions, or electric fans.</li> <li>Move the monitor away from power lines or place a magnetic shield near the monitor.</li> <li>Try plugging the monitor into a different AC outlet, preferably on a different circuit.</li> <li>Try turning the monitor 90° to the left or right.</li> </ul> <p>■ <b>Problems caused by the connected computer or other equipment</b></p> <ul style="list-style-type: none"> <li>Check your graphics board manual for the proper monitor setting.</li> <li>Confirm that the graphics mode (VESA, Macintosh 21" Color, etc.) and the frequency of the input signal are supported by this monitor (Appendix). Even if the frequency is within the proper range, some graphics boards may have a sync pulse that is too narrow for the monitor to sync correctly.</li> <li>Adjust the computer's refresh rate (vertical frequency) to obtain the best possible picture.</li> </ul>
<b>Picture is fuzzy</b>	<ul style="list-style-type: none"> <li>Adjust the contrast and brightness (page 12).</li> <li>Degauss the monitor* (page 14).</li> <li>Adjust the degree of moire cancellation until the moire is minimal, or set CANCEL MOIRE to OFF (page 14).</li> </ul>

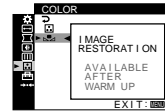

Symptom	Check these items
<b>Picture is ghosting</b>	<ul style="list-style-type: none"> <li>Eliminate the use of video cable extensions and/or video switch boxes.</li> <li>Check that all plugs are firmly seated in their sockets.</li> </ul>
<b>Picture is not centered or sized properly</b>	<ul style="list-style-type: none"> <li>Set the AUTO (Ⓢ) function to OK (on) in the SIZE/CENTER menu (page 13).</li> <li>Adjust the size or centering (page 12). Note that with some input signals and/or graphics boards the periphery of the screen is not fully utilized.</li> </ul>
<b>Edges of the image are curved</b>	<ul style="list-style-type: none"> <li>Adjust the geometry (page 13).</li> </ul>
<b>Wavy or elliptical pattern (moire) is visible</b>	<ul style="list-style-type: none"> <li>Adjust the degree of moire cancellation until the moire is minimal (page 14).</li> </ul> <p>■ <b>Problems caused by the connected computer or other equipment</b></p> <ul style="list-style-type: none"> <li>Change your desktop pattern.</li> </ul>
<b>Color is not uniform</b>	<ul style="list-style-type: none"> <li>Degauss the monitor* (page 14). If you place equipment that generates a magnetic field, such as a speaker, near the monitor, or if you change the direction the monitor faces, color may lose uniformity.</li> <li>Adjust the landing (page 14) (CPD-G520 only).</li> </ul>
<b>White does not look white</b>	<ul style="list-style-type: none"> <li>Adjust the color temperature (page 15).</li> <li>Check that the 5 BNC connectors are connected in the correct order (page 6).</li> </ul>
<b>Letters and lines show red or blue shadows at the edges</b>	<ul style="list-style-type: none"> <li>Adjust the convergence (page 14).</li> </ul>
<b>Monitor buttons do not operate (ON appears on the screen)</b>	<ul style="list-style-type: none"> <li>If the control lock is set to ON, set it to OFF (page 17).</li> </ul>
<b>IMAGE RESTORATION function does not operate</b>	<ul style="list-style-type: none"> <li>Before using this function, the monitor must be in normal operation mode (green power indicator on) for at least 30 minutes. For more information on using the IMAGE RESTORATION function, see page 17.</li> <li>Adjust the computer's power saving settings to keep the monitor in normal operation mode for more than 30 minutes.</li> <li>The monitor may gradually lose its ability to perform this function due to the natural aging of the picture tube.</li> </ul>
<b>USB peripherals do not function</b>	<ul style="list-style-type: none"> <li>Check that the appropriate USB connectors are securely connected (page 8).</li> <li>Check that the (power) switch is in the "on" position. Then reconnect the USB cable to the monitor.</li> </ul> <p>■ <b>Problems caused by the connected computer or other equipment</b></p> <ul style="list-style-type: none"> <li>Check that the power of any self-powered USB compliant peripheral devices is "on."</li> <li>Install the latest version of the device driver on your computer. Contact your device's manufacturer for information about the appropriate device driver.</li> <li>If your USB compliant keyboard or mouse does not function, connect them directly to your computer, reboot your computer, and make any necessary adjustments to the USB settings. Then reconnect the keyboard or mouse to the monitor. If you connect a keyboard or mouse to the USB connectors and then boot your computer for the first time, the peripheral devices may not function.</li> </ul>
<b>A hum is heard right after the power is turned on</b>	<ul style="list-style-type: none"> <li>This is the sound of the auto-degauss cycle. When the power is turned on, the monitor is automatically degaussed for a few seconds.</li> </ul>



US

\* If a second degauss cycle is needed, allow a minimum interval of 20 minutes for the best result. A humming noise may be heard, but this is not a malfunction.

## Self-diagnosis function

This monitor is equipped with a self-diagnosis function. If there is a problem with your monitor or computer(s), the screen will go blank and the  (power) indicator will either light up green or flash orange. If the  (power) indicator is lit in orange, the computer is in power saving mode. Try pressing any key on the keyboard or moving the mouse.

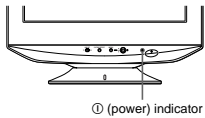

### ■ If the (power) indicator is green

- 1 **Disconnect any plugs from the video input 1 and 2 connectors, or turn off the connected computer(s).**
- 2 **Press the  (power) button twice to turn the monitor off and then on.**
- 3 **Hold the control button upward for 2 seconds before the monitor enters power saving mode.**

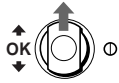



If all four color bars appear (white, red, green, blue), the monitor is working properly. Reconnect the video input cables and check the condition of your computer(s).

If the color bars do not appear, there is a potential monitor failure. Inform your authorized Sony dealer of the monitor's condition.

### ■ If the (power) indicator is flashing orange

**Press the  (power) button twice to turn the monitor off and then on.**

If the  (power) indicator lights up green, the monitor is working properly.

If the  (power) indicator is still flashing, there is a potential monitor failure. Count the number of seconds between orange flashes of the  (power) indicator and inform your authorized Sony dealer of the monitor's condition. Be sure to note the model name and serial number of your monitor. Also note the make and model of your computer and graphic board.

## Specifications

### CPD-G520

CRT	0.24 mm aperture grille pitch 21 inches measured diagonally 90-degree deflection FD Trinitron
Viewable image size	Approx. 403.8 × 302.2 mm (w/h) (16 × 12 inches) 19.8" viewing image
Resolution	
Maximum	Horizontal: 2048 dots Vertical: 1536 lines
Recommended	Horizontal: 1600 dots Vertical: 1200 lines
Input signal levels	Video signal Analog RGB: 0.700 Vp-p (positive), 75 Ω SYNC signal H/V separate or composite sync: TTL 2 kΩ, Polarity free Sync on Green: 0.3 Vp-p (negative)
Standard image area	Approx. 388 × 291 mm (w/h) (15 <sup>3</sup> / <sub>8</sub> × 11 <sup>1</sup> / <sub>2</sub> inches) or Approx. 364 × 291 mm (w/h) (14 <sup>3</sup> / <sub>8</sub> × 11 <sup>1</sup> / <sub>2</sub> inches)
Deflection frequency*	Horizontal: 30 to 130 kHz Vertical: 48 to 170 Hz
AC input voltage/current	100 to 240 V, 50 – 60 Hz, 2.0 – 1.0 A
Power consumption	Approx. 135 W (with no USB devices connected)
Dimensions	Approx. 497 × 502 × 485 mm (w/h/d) (19 <sup>7</sup> / <sub>8</sub> × 19 × 18 <sup>7</sup> / <sub>8</sub> inches)
Mass	Approx. 30 kg (66 lb 2 oz)
Plug and Play	DDC2B/DDC2Bi, GTF**
Supplied accessories	See page 6

### CPD-G420

CRT	0.24 mm aperture grille pitch 19 inches measured diagonally 90-degree deflection FD Trinitron
Viewable image size	Approx. 365 × 274 mm (w/h) (14 <sup>3</sup> / <sub>8</sub> × 10 <sup>7</sup> / <sub>8</sub> inches) 18.0" viewing image
Resolution	
Maximum	Horizontal: 1920 dots Vertical: 1440 lines
Recommended	Horizontal: 1280 dots Vertical: 1024 lines
Input signal levels	Video signal Analog RGB: 0.700 Vp-p (positive), 75 Ω SYNC signal H/V separate or composite sync: TTL 2 kΩ, Polarity free Sync on Green: 0.3 Vp-p (negative)
Standard image area	Approx. 352 × 264 mm (w/h) (13 <sup>7</sup> / <sub>8</sub> × 10 <sup>1</sup> / <sub>2</sub> inches) or Approx. 330 × 264 mm (w/h) (13 × 10 <sup>1</sup> / <sub>2</sub> inches)
Deflection frequency*	Horizontal: 30 to 110 kHz Vertical: 48 to 170 Hz
AC input voltage/current	100 to 240 V, 50 – 60 Hz, 2.0 – 1.0 A
Power consumption	Approx. 130 W (with no USB devices connected)
Dimensions	Approx. 451 × 471 × 461 mm (w/h/d) (17 <sup>7</sup> / <sub>8</sub> × 18 <sup>5</sup> / <sub>8</sub> × 18 <sup>1</sup> / <sub>4</sub> inches)
Mass	Approx. 25.5 kg (56 lb 3 oz)
Plug and Play	DDC2B/DDC2Bi, GTF**
Supplied accessories	See page 6

- \* Recommended horizontal and vertical timing condition
- Horizontal sync width duty should be more than 4.8% of total horizontal time or 0.8 μs, whichever is larger.
  - Horizontal blanking width should be more than 2.3 μsec.
  - Vertical blanking width should be more than 450 μsec.
- \*\* If the input signal is Generalized Timing Formula (GTF) compliant, the GTF feature of the monitor will automatically provide an optimal image for the screen.

Design and specifications are subject to change without notice.

US

## SECTION 2 DISASSEMBLY

### 2-1. CABINET REMOVAL

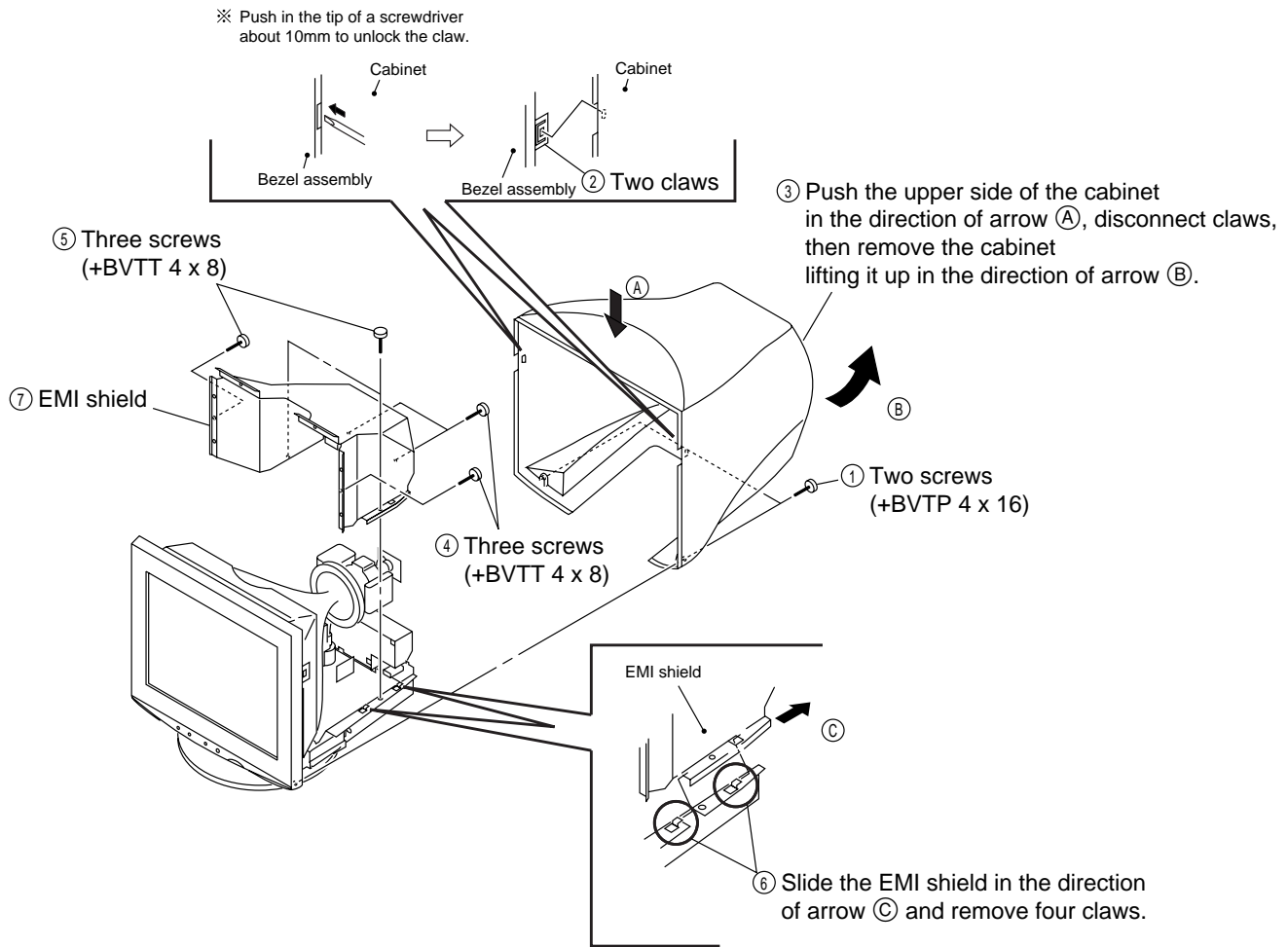

### 2-2. A1 BOARD (C BLOCK) REMOVAL

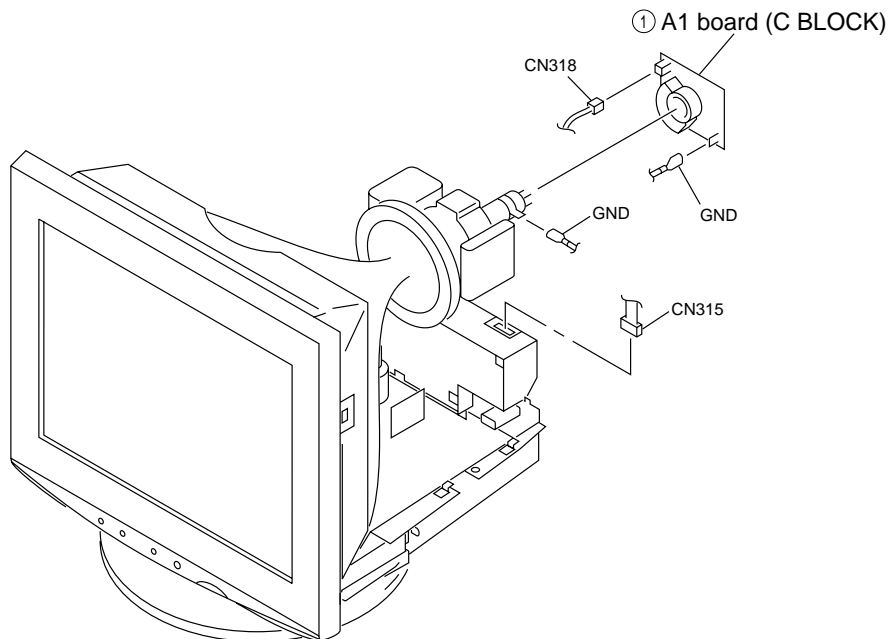



**2-3. A1 BOARD, US BOARD REMOVAL  
[US MODEL]**

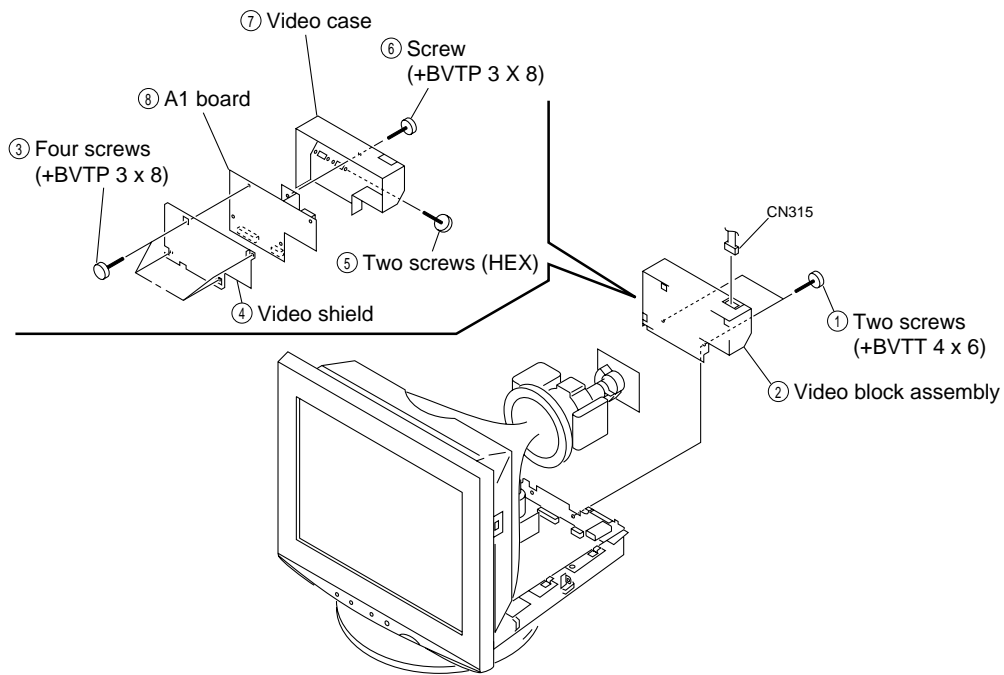

**[NH, SH, EQ MODEL]**

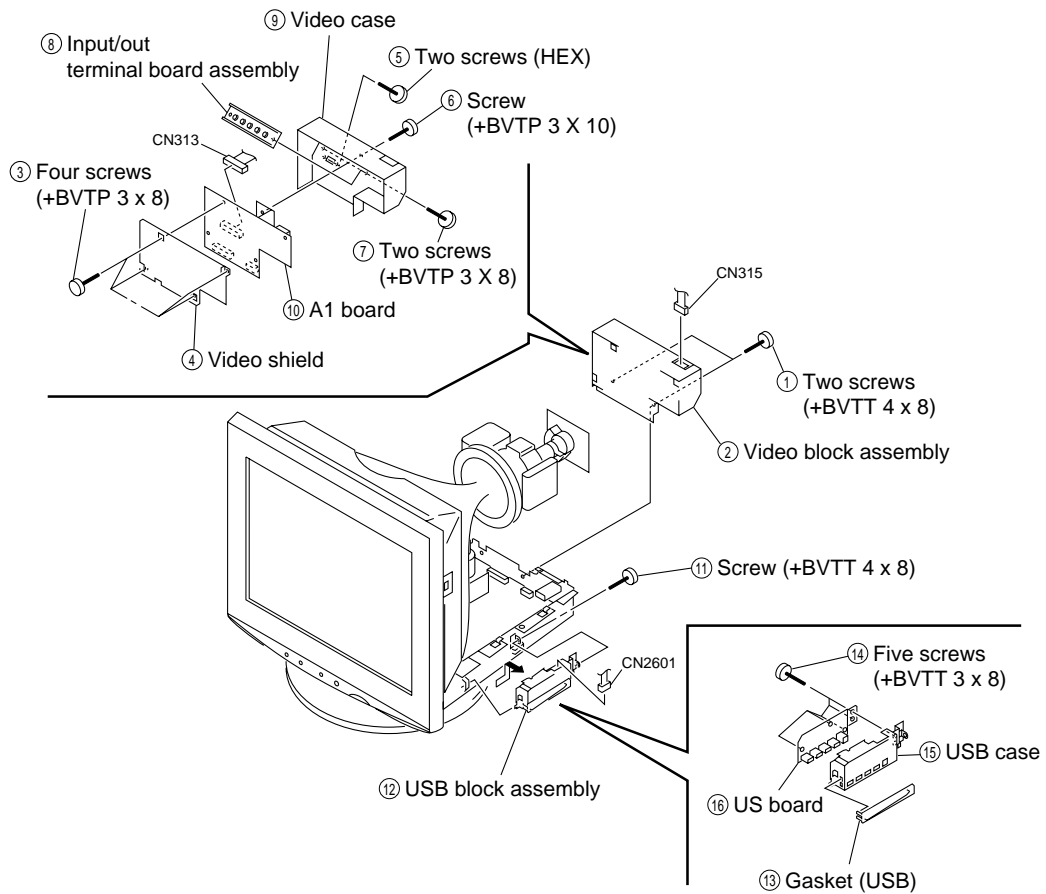

**2-4. BEZEL ASSEMBLY, H1 BOARD, MAGNETIC SENSOR REMOVAL**

- ① Before removing the bezel assembly, secure the picture tube by attaching two screws to the picture tube shield at the positions shown with an arrow (diagonal two places) to prevent the picture tube from falling.  
 (Use the screws +BVTT 4 x 8 that fix EMI shield.)

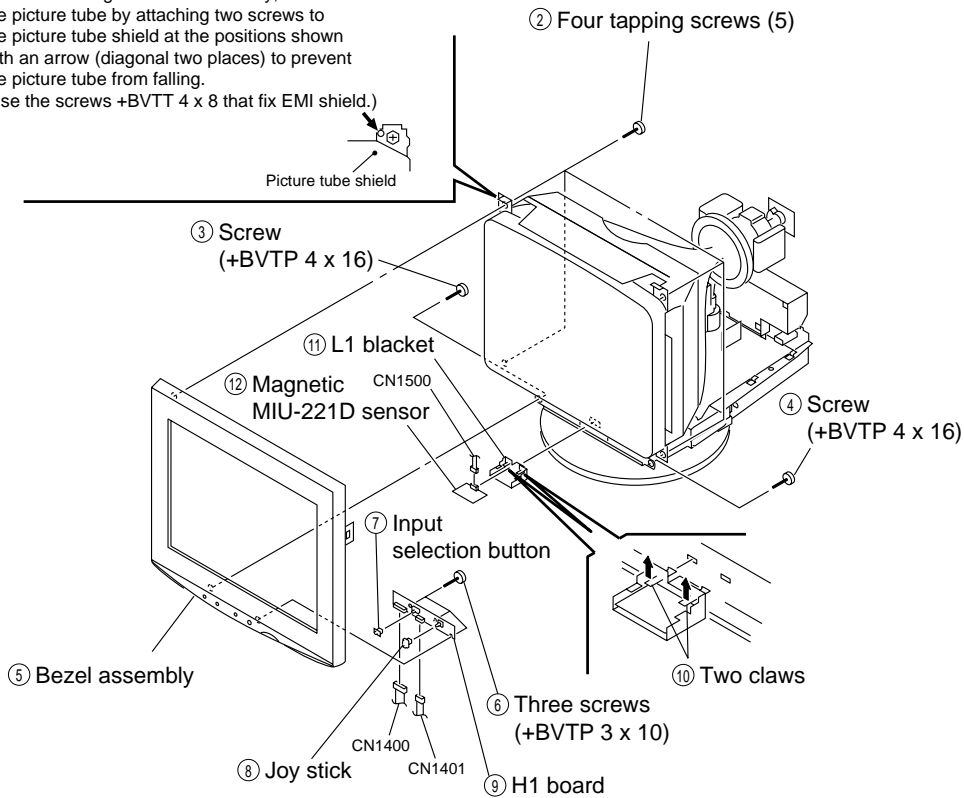

**2-5. D BOARD REMOVAL**

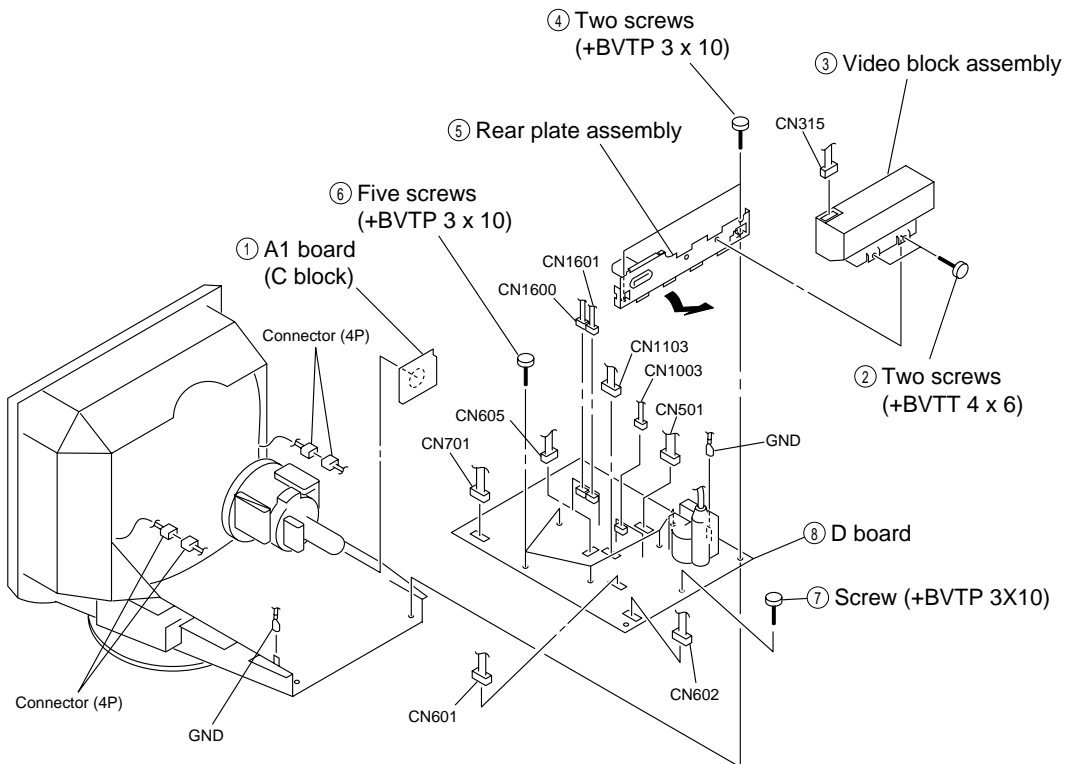

## 2-6. SERVICE POSITION

- ① Remove the D board.
- ② Remove the Video block assembly.
- ③ Install the Adaptor board (XT MOUNT) (A-1391-123-A).
- ④ Lay the Video block assembly.

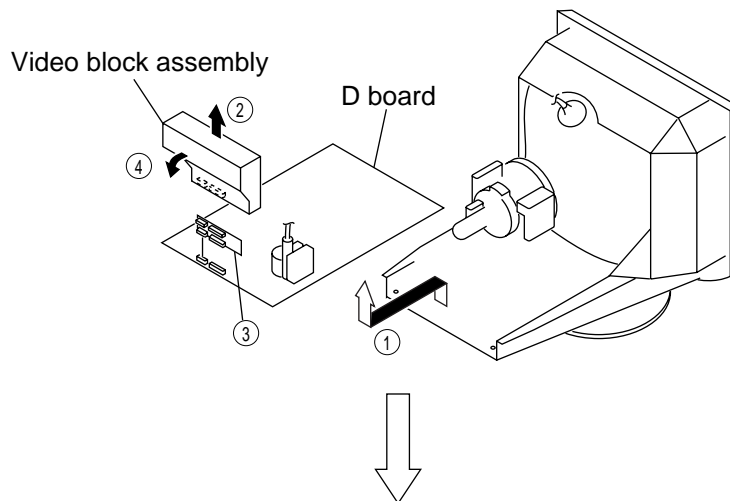

- ⑤ Install the video block assembly.

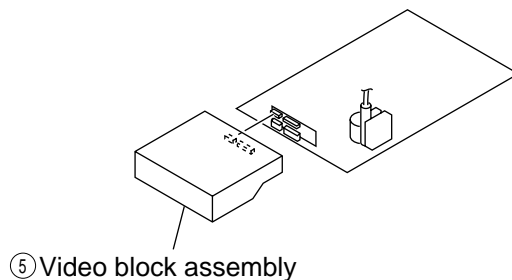

- ⑥ Put a box which is about 15cm in height under the D board to fix it.

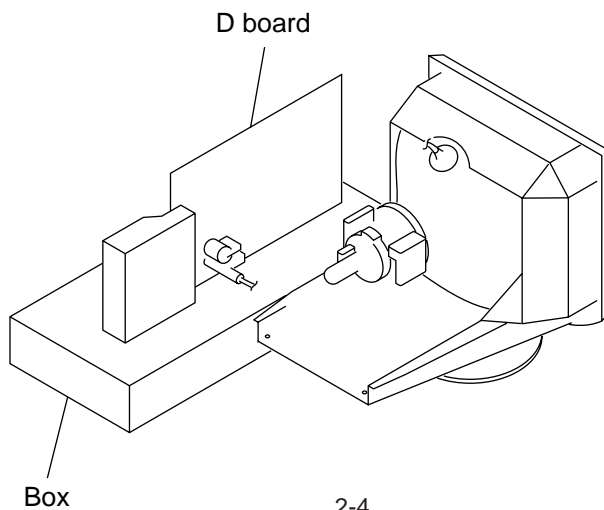

2-7. PICTURE TUBE REMOVAL

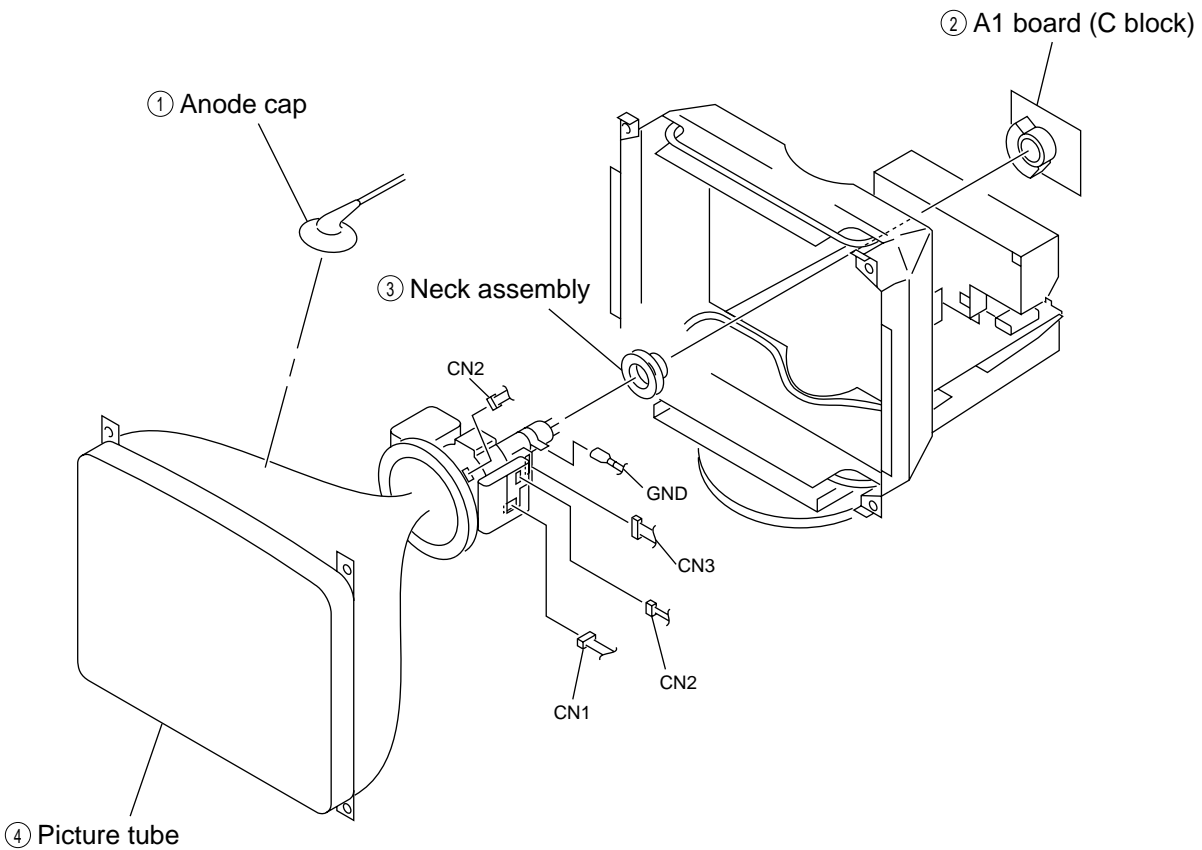

• REMOVAL OF ANODE-CAP

NOTE: Short circuit the anode of the picture tube and the anode cap to the metal chassis, CRT shield or carbon painted on the CRT, after removing the anode.

• REMOVING PROCEDURES

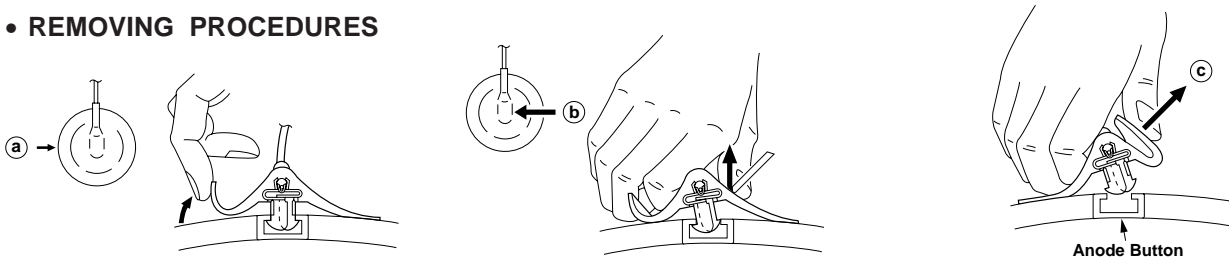

- ① Turn up one side of the rubber cap in the direction indicated by the arrow (a).
- ② Using a thumb pull up the rubber cap firmly in the direction indicated by the arrow (b).
- ③ When one side of the rubber cap is separated from the anode button, the anode-cap can be removed by turning up the rubber cap and pulling up it in the direction of the arrow (c).

• HOW TO HANDLE AN ANODE-CAP

- ① Don't scratch the surface of anode-caps with sharp shaped material!
- ② Don't press the rubber hardy not to damage inside of anode-caps!  
A material fitting called as shatter-hook terminal is built in the rubber.
- ③ Don't turn the foot of rubber over hardy!  
The shatter-hook terminal will stick out or damage the rubber.

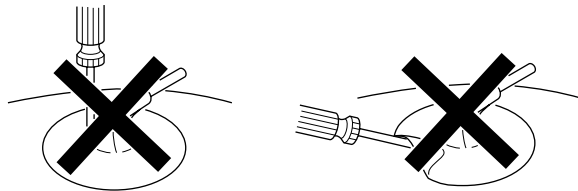

2-8. HARNESS LOCATION

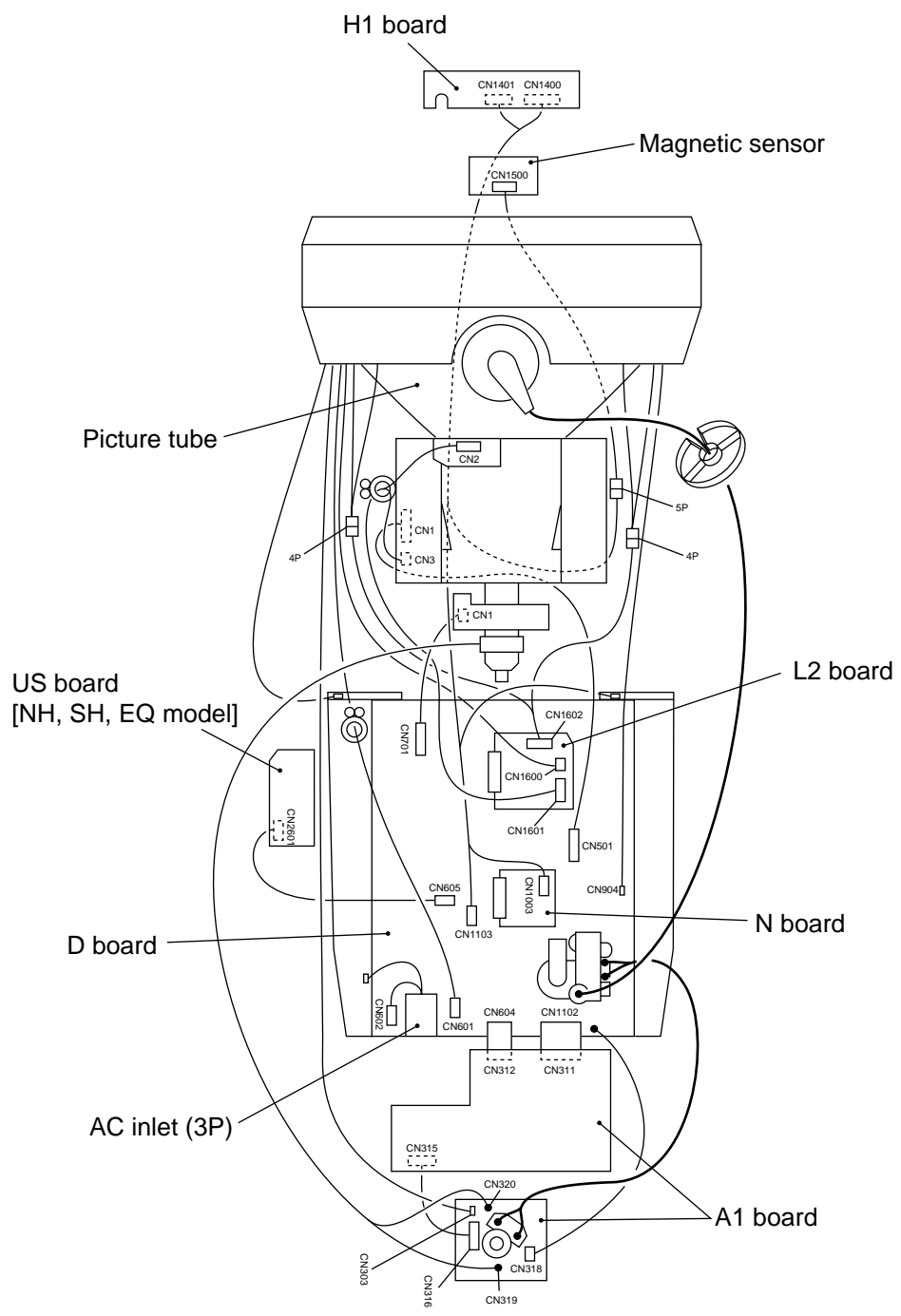

## SECTION 3 SAFETY RELATED ADJUSTMENT

When replacing or repairing the shown below table, the following operational checks must be performed as a safety precaution against X-rays emissions from the unit.

	Part Replaced (☒)
HV ADJ	RV901

	Part Replaced (☒)
HV Regulator Circuit Check	D Board C925, IC901, R901, R902, R905, R924, R925, R926, RV901, T901 (FBT) • Mounted D Board
HV Protector Circuit Check	D Board C920, C923, D911, D912, R903, R917, R918, R919, R920, R923, T901 (FBT) • Mounted D Board N Board IC1001, RB1001 • Mounted N Board
Beam Current Protector Circuit Check	D Board C930, D917, R921, R932, R933, R935, T901 (FBT) • Mounted D Board N Board IC1001, RB1001 • Mounted N Board

\* Confirm one minute after turning on the power.

### a) HV Regulator Circuit Check

- 1) Turn the RV901 slowly, and adjustment so that high voltage is in the specified range.  
[Specification]:  $27.00 \pm 0.05$  kV
- 2) Check that the voltage of D912 cathode on the D board is 17.0 V or more.

### b) HV Protector Circuit Check

- 1) Using external DC Power Supply, apply the voltage shown below between cathode of D912 and GND, and check that the RASTER disappears.  
[Specification]:  $19.95 + 0.00/- 0.05$  V

### c) Beam Current Protector Circuit Check

- 1) Connect constant current source to a section between T901 (FBT) ⑩ pin and GND, and check that the RASTER disappears when the specified current flows to the ⑩ pin.  
[Specification]:  $2.12 + 0.00/- 0.01$  mA

## SECTION 4 ADJUSTMENTS

**Note: Hand degauss must be used on stand-by or power-off condition.**

**This model has an automatic earth magnetism correction function by using an earth magnetism sensor and a LCC coil. When using a hand degauss while monitor (LCC coil) is being operated, it sometimes gets magnetized, and the system may not work properly as a result.**

### • Landing Rough Adjustment

1. Display all white pattern (or black dot pattern).
2. Set contrast to 255.
3. Display green plain pattern.
4. Side back DY and roughly adjust green plain pattern to be centered on the useful screen with Purity Magnet.
5. Adjust DY tilt.

Note: Set ROTATION to 128 and LCC\_NS to 128 when adjusting DY tilt.

6. Lightly tighten the DY screw.

### • Landing Fine Adjustment

Note: (1) After adjust W/B (9300k), measure the average of IK with all white video input, while CONTRAST is maximum and BRIGHTNESS is center. And adjustment shall be made so that the miss-landing become least after aging 2H with the IK 30% of measured value shown above.

(2) The magnetic field shall be BH = 0.

(3) When adjusting at other than BH = 0, calculate the shifted value from BH = 0.

1. Put the monitor in helmholz coil.
  2. Set as follows;  
LCC\_SW = 0 (LCC Correction Current = 0)  
FUNCTION\_SW bit1 = (Auto Degauss = On)  
CONTRAST = 255
  3. Display green plain pattern.
  4. Degauss the iron part of chassis with a hand degausser and degauss coil.
  5. Degauss CRT face with a hand degausser again.
  6. Input AC 230V to AC IN and turn the monitor off and on. Then auto-degauss works.
  7. Reset FUNCTION\_SW bit1 to 0 (auto-degauss = off)
  8. Degauss CRT face with a hand degausser again.
  9. Attach wobbling coil to the specified place on CRT neck.
  10. Put on landing sensor to CRT face.
  11. Set LCC\_SW to 12.
  12. With landing checker, adjust DY position, purity, DY center and landing of the 4 corners.
  13. Read VX and VY value which are the read out of magnetic sensor, and write to "LCC\_VX\_REF" and "LCC\_VY\_REF".
  14. Adjust landing by LCC\_NS, LCC\_LT, LCC\_LB, LCC\_RT, and LCC\_RB. Adjustment of registers shall be limited within the following range.  
LCC\_NS: 128 ± 15  
LCC\_LT, LCC\_LB, LCC\_RT, and LCC\_RB: 128 ± 40
- Set LCC\_SW to 13, and Perform Service Save.

<Specifications>

Adjust so that the green is within the specification given right.

4 corner adjust target : within ± 1

(μm)		
0 ± 3	0 ± 7.5	0 ± 3
0 ± 3	0 ± 7.5	0 ± 3
0 ± 3	0 ± 7.5	0 ± 3

The red and blue must be within the specification given right with respect to the green.

(μm)		
± 6	± 6	± 6
± 6	± 6	± 6
± 6	± 6	± 6

A difference between red and blue must be within the specification given right.

(μm)		
10	10	10
10	7	10
10	10	10

15. Tighten DY screw within specified torque, and auto-degauss.

Note: Torque 22 ± 2 kgcm (2.2 ± 0.2Nm)

16. Adjust the vertical angle of DY to make top and bottom pins equal (a = b). The horizontal angle shall not be changed (straight). Settle DY upright without leaning, and insert wedges firmly so that DY shall not move.

<How to place wedge>

Green plain crosshatch pattern

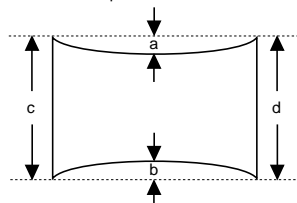

a and b should be equal.  
c and d should be equal.

Plaster RTV to both sides for the upper wedge.  
Make sure that they settle inside DY.

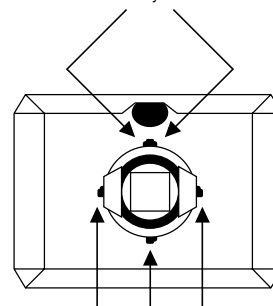

Plaster RTV to one side for other wedges.

17. Adjust top and bottom pins correction VR.
18. Adjust the horizontal trapezoid distortion by DY horizontal trapezoid correction VR.
19. Check landing at each corner and in case not in specification, adjust landing of 4 corners with "LCC\_NS", "LCC\_LT", "LCC\_LB", "LCC\_RT", and "LCC\_RB". The limitations of registers are shown below.  
LCC\_NS: 128 ± 15  
LCC\_LT, LCC\_LB, LCC\_RT, and LCC\_RB: 128 ± 40
20. Remove the sensor and wobbling coil.
21. Switch signals to R, G, and B, and then check that the pure colors have good color purity.
22. Fix purity magnets with white paint.

Connect the communication cable of the computer to the connector located on the D board. Run the service software and then follow the instruction.

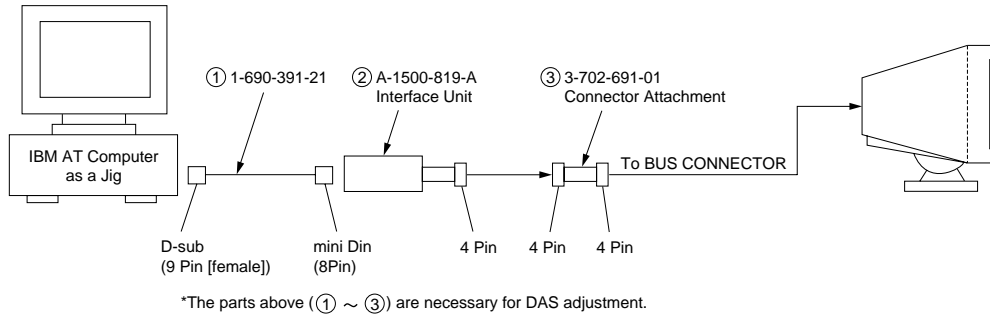

**• Convergence Rough Adjustment**

- (1) Display white crosshatch pattern.
- (2) Pile the convex parts of 6-pole magnet for convergence together.
- (3) Roughly adjust H.CONV and V.CONV with 4-pole magnet.

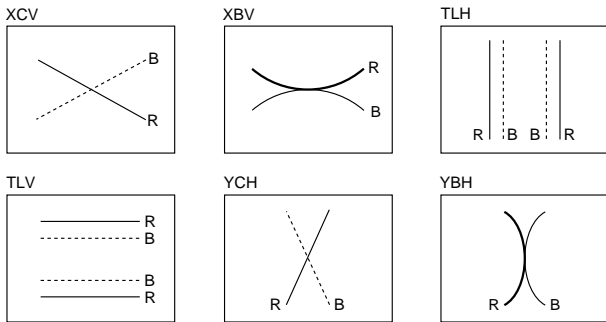
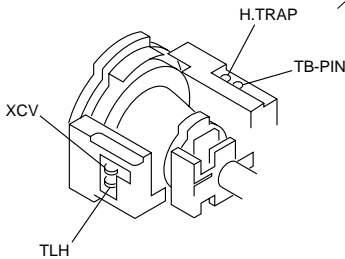
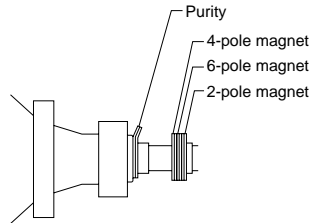

**• Convergence Specification**

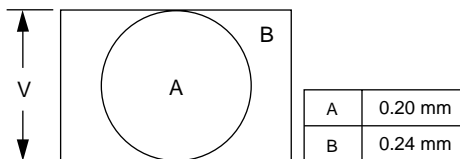

**• White Balance Adjustment Specification**

1. 9300 K  
 $x = 0.283 \pm 0.005$   
 $y = 0.298 \pm 0.005$   
 (All White)
2. 6500 K  
 $x = 0.313 \pm 0.005$   
 $y = 0.329 \pm 0.005$   
 (All White)
3. 5000 K  
 $x = 0.346 \pm 0.005$   
 $y = 0.359 \pm 0.005$   
 (All White)

**• Vertical and Horizontal Position and Size Specification**

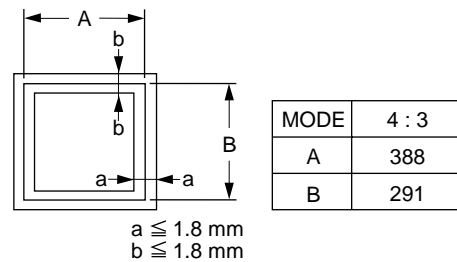

**• Focus adjustment**

Adjust the focus volume 1 and 2 for the optimum focus.

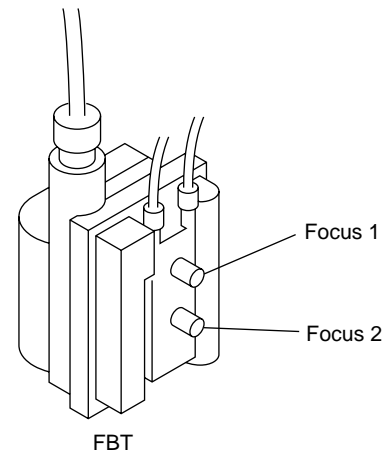



# SECTION 5 DIAGRAMS

## 5-1. BLOCK DIAGRAMS

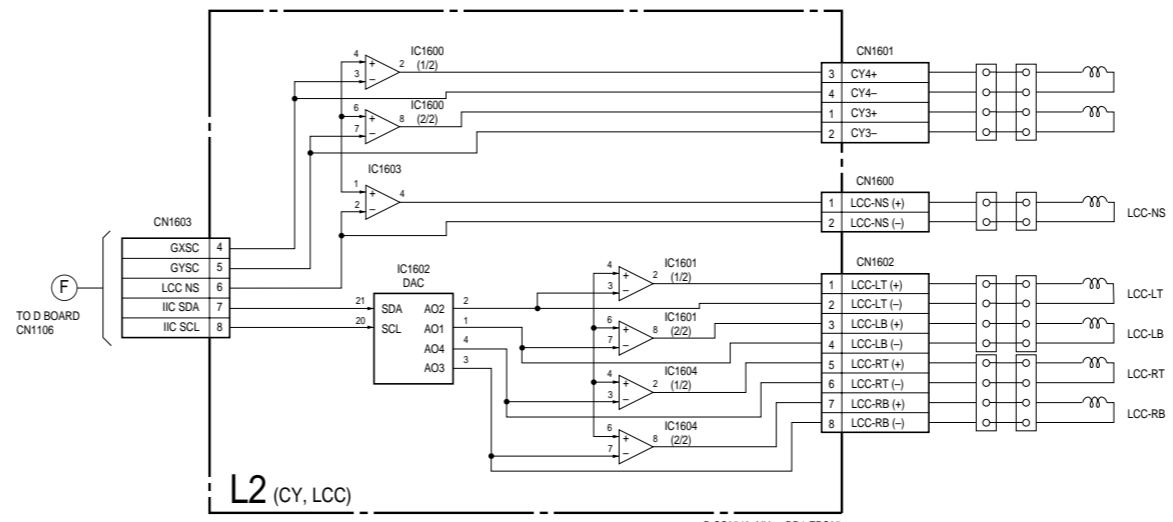
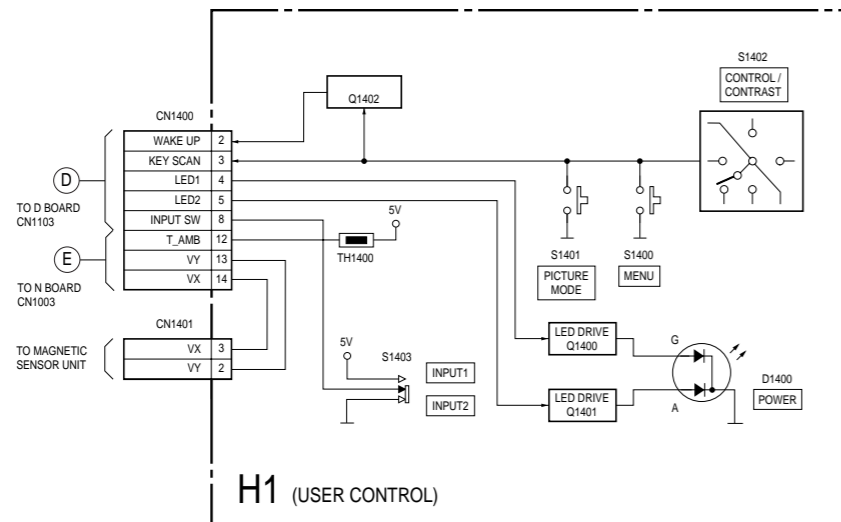
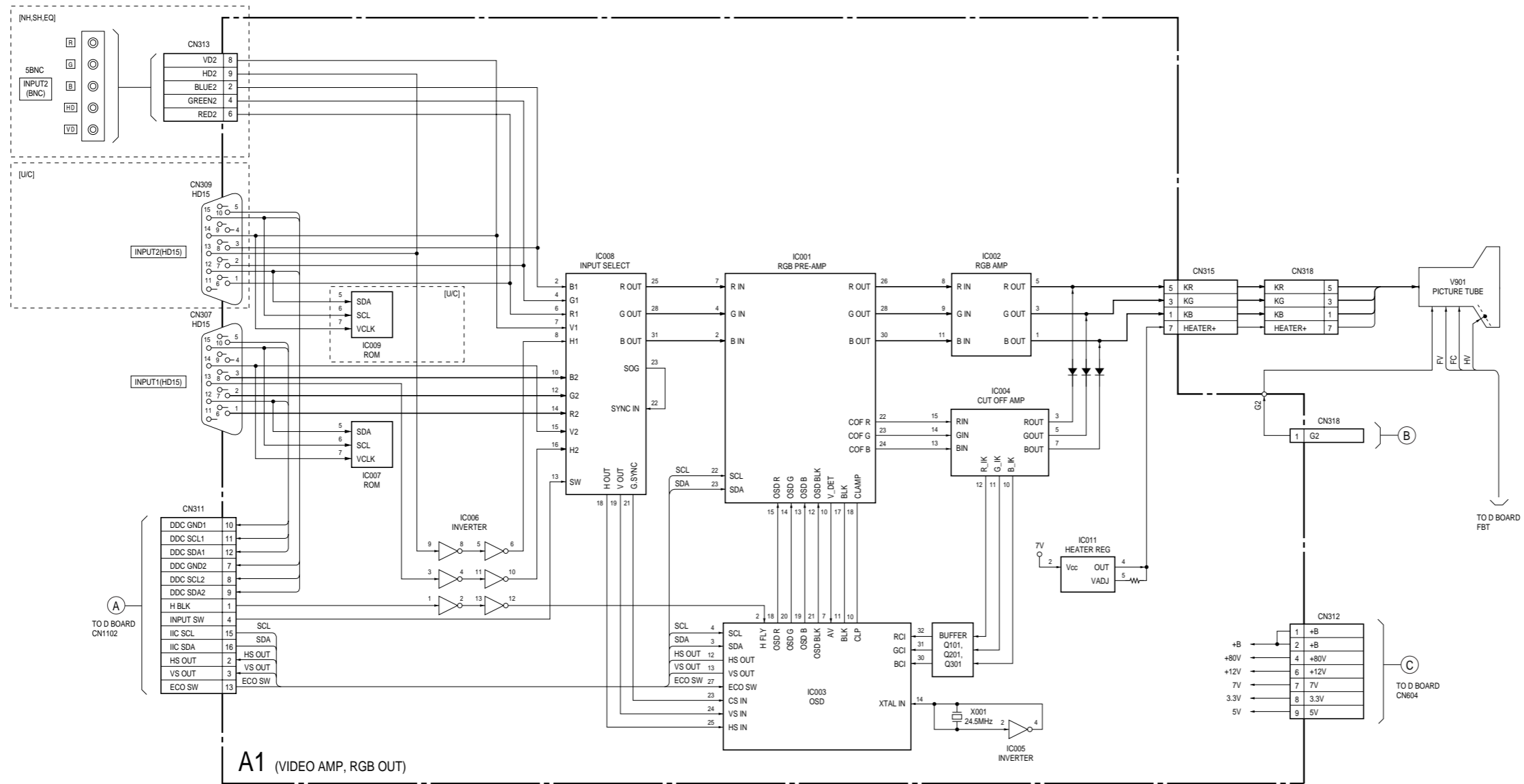

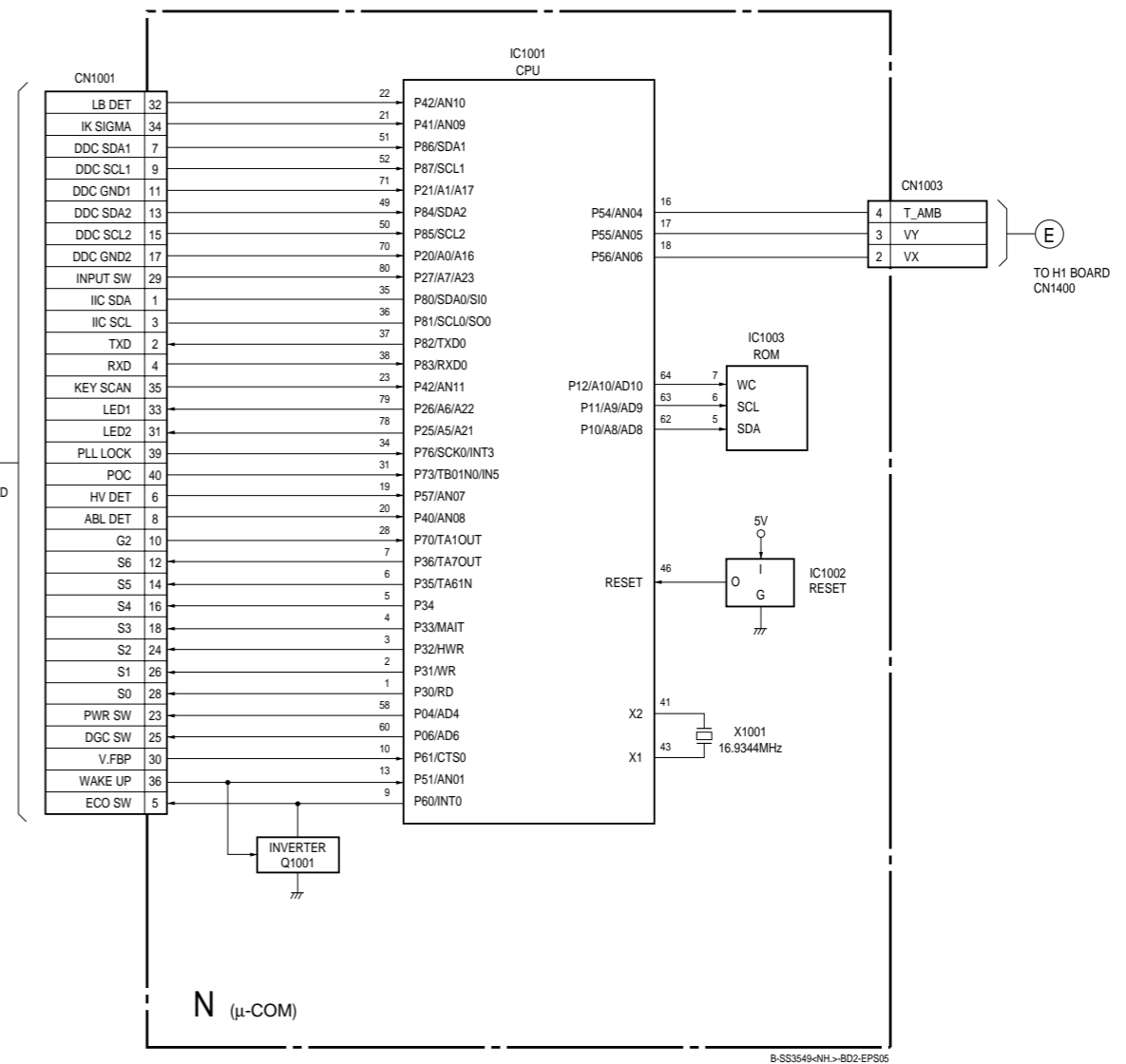
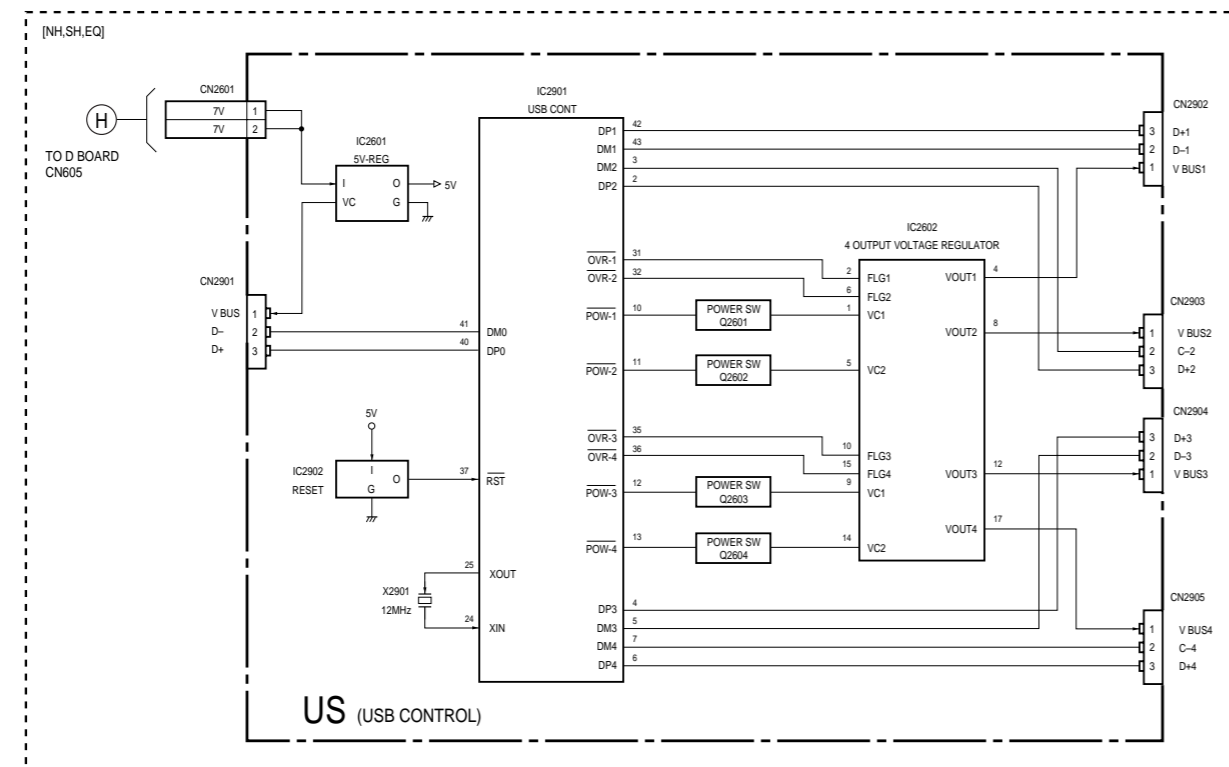
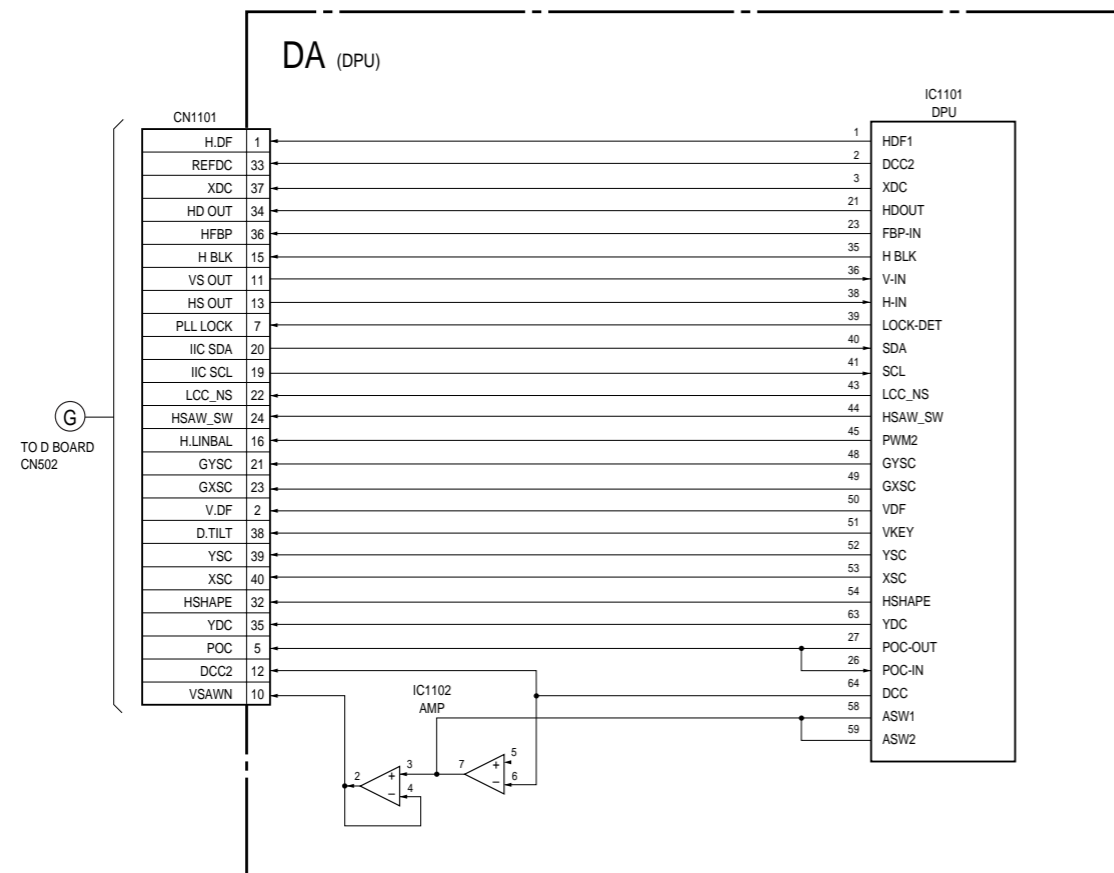

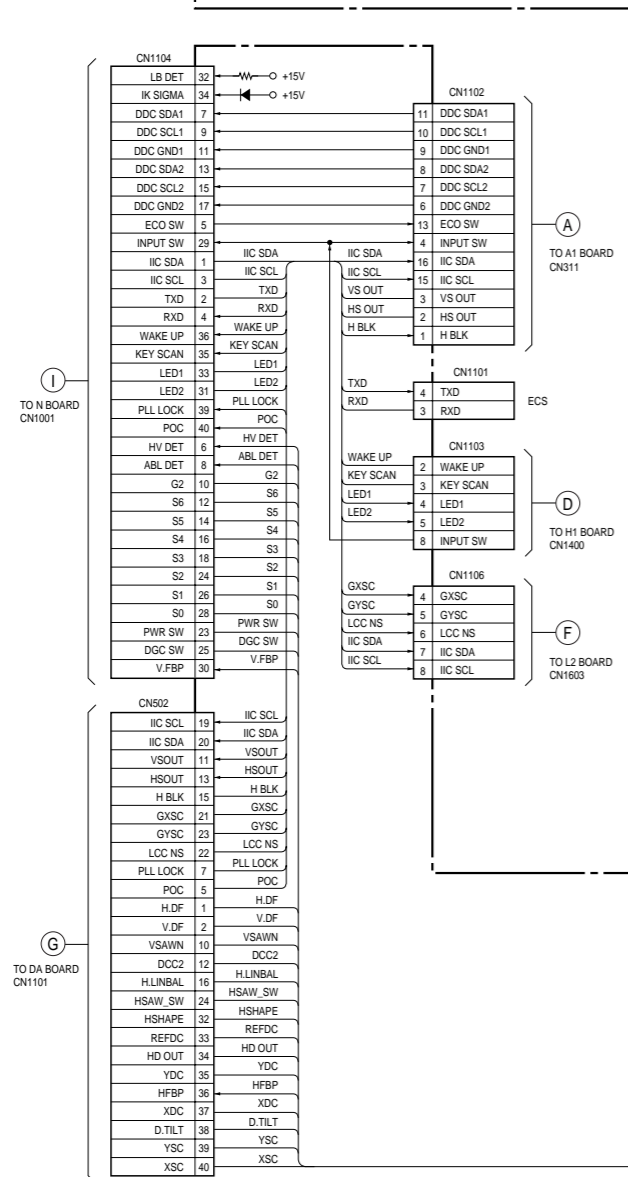
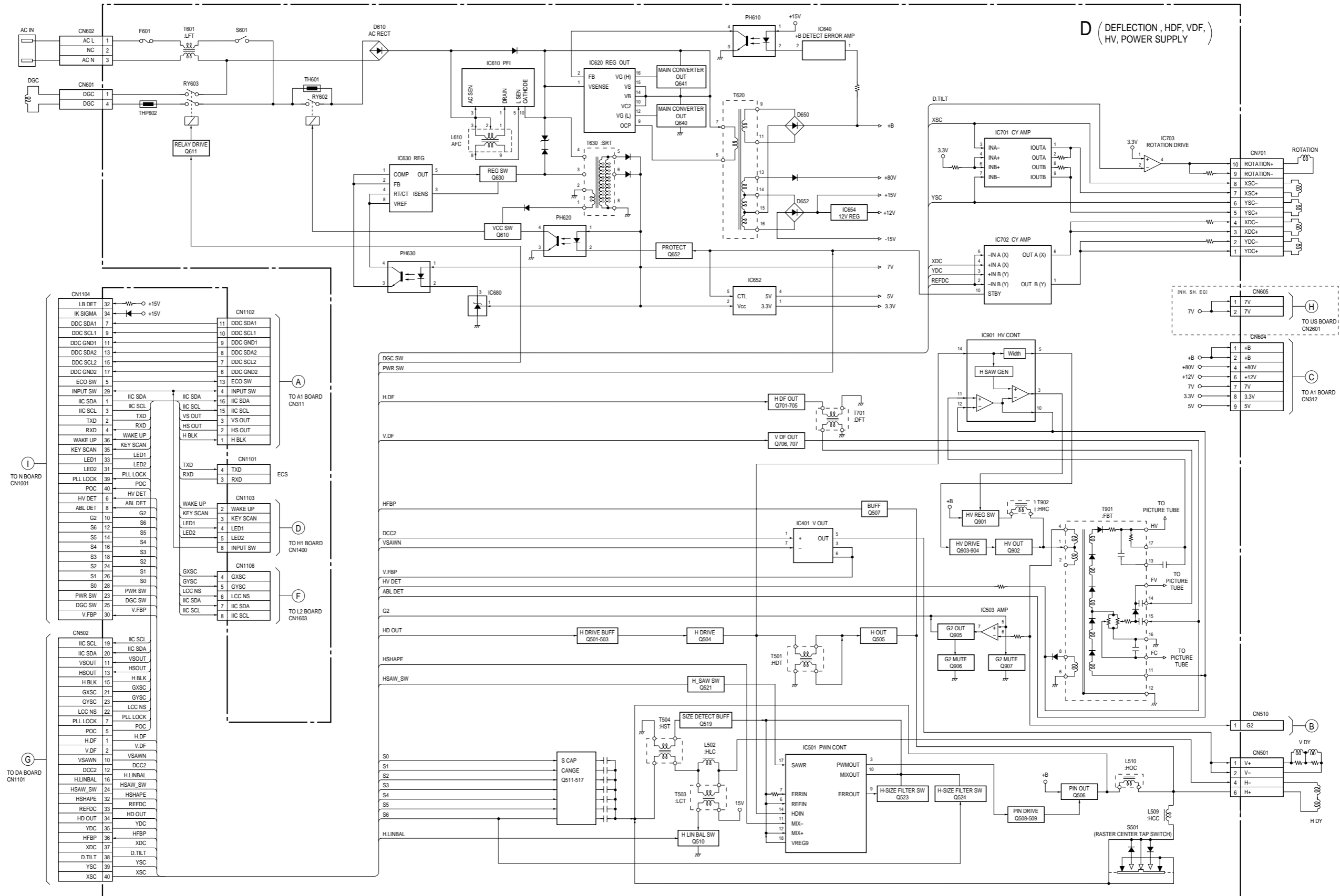

5-2. FRAME SCHEMATIC DIAGRAM

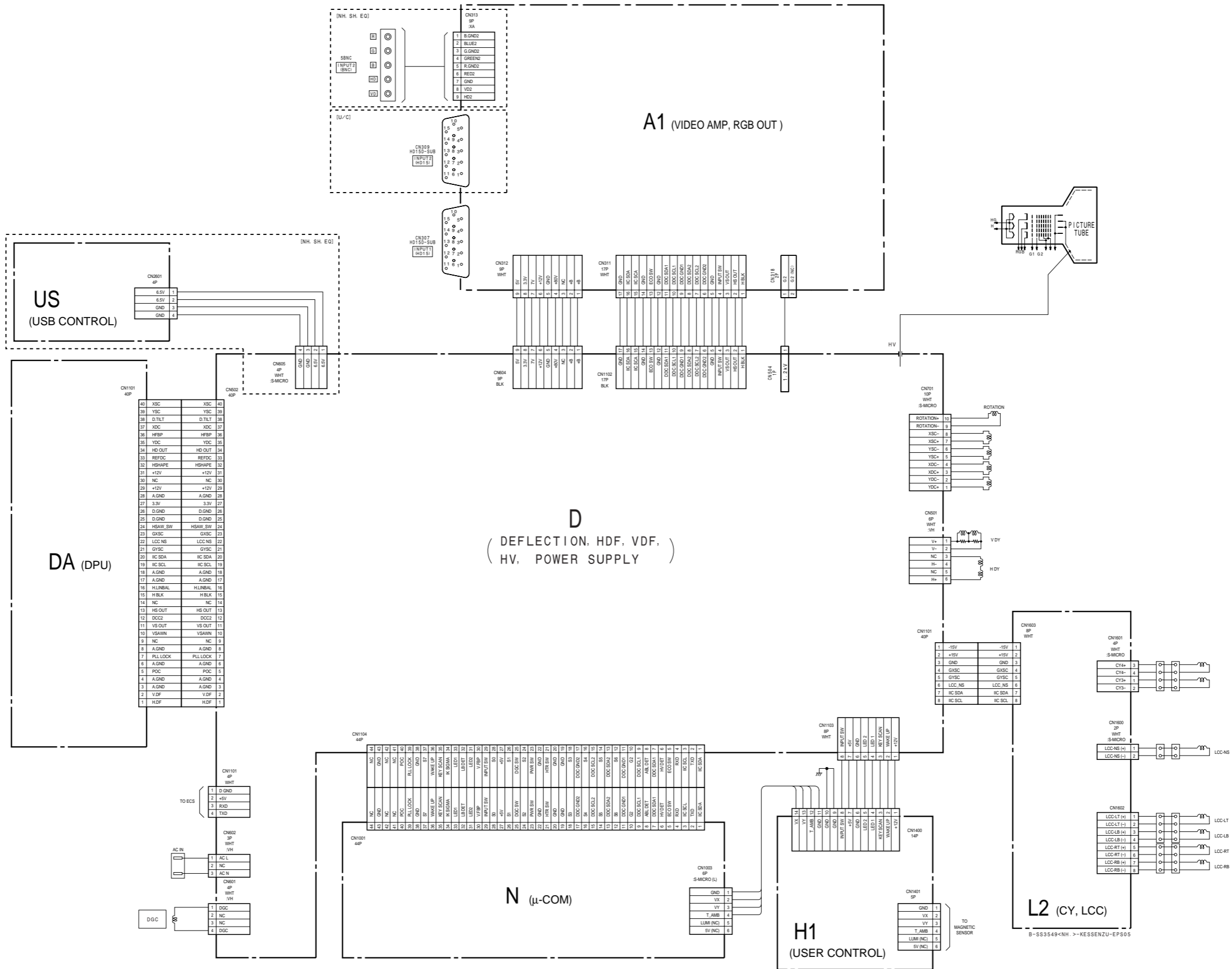

### 5-3. CIRCUIT BOARDS LOCATION

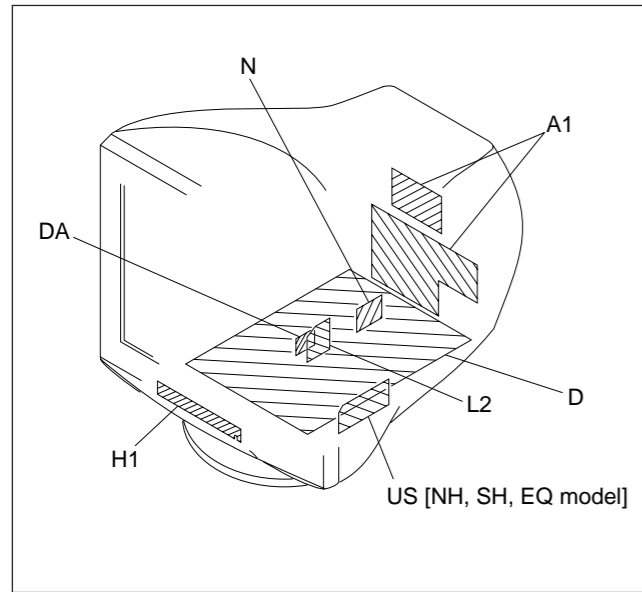

### 5-4. SCHEMATIC DIAGRAMS AND PRINTED WIRING BOARDS

**Note:**

- All capacitors are in  $\mu\text{F}$  unless otherwise noted. (pF:  $\mu\text{pF}$ ) Capacitors without voltage indication are all 50 V.
- Indication of resistance, which does not have one for rating electrical power, is as follows.

Pitch: 5 mm  
Rating electrical power 1/4 W (CHIP : 1/10 W)

- All resistors are in ohms.
- : nonflammable resistor.
- : fusible resistor.
- $\Delta$  : internal component.
- : panel designation, and adjustment for repair.
- All variable and adjustable resistors have characteristic curve B, unless otherwise noted.
- $\perp$  : earth-ground.
- : earth-chassis.
- The components identified by in this basic schematic diagram have been carefully factory-selected for each set in order to satisfy regulations regarding X-ray radiation. Should replacement be required, replace only with the value originally used.
- When replacing components identified by , make the necessary adjustments indicated. (See page 3-1)
- When replacing the part in below table, be sure to perform the related adjustment.

**Note: The components identified by shading and mark  $\Delta$  are critical for safety. Replace only with part number specified.**

**Note: Les composants identifiés par un tramé et une marque  $\Delta$  sont critiques pour la sécurité. Ne les remplacer que par une pièce portant le numéro spécifié.**

- All voltages are in V.
- Readings are taken with a 10 M digital multimeter.
- Readings are taken with a color-bar signal input.
- Voltage variations may be noted due to normal production tolerances.
- \* : Can not be measured.
- Circled numbers are waveform references.
- : B + bus.
- : B - bus.

**Divided circuit diagram**

One sheet of D board circuit diagram is divided into three sheets, each having the code D- $\text{\textcircled{a}}$  to D- $\text{\textcircled{c}}$ . For example, the destination  $\text{\textcircled{ab1}}$  on the code D- $\text{\textcircled{a}}$  sheet is connected to  $\text{\textcircled{ab1}}$  on the D- $\text{\textcircled{b}}$  sheet.

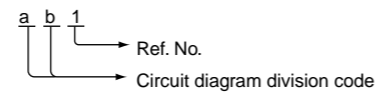

	Part Replaced ()
HV ADJ	RV901

	Part Replaced ()
HV Regulator Circuit Check	D Board C925, IC901, R901, R902, R905, R924, R925, R926, RV901, T901 (FBT) • Mounted D Board
HV Protector Circuit Check	D Board C920, C923, D911, D912, R903, R917, R918, R919, R920, R923, T901 (FBT) • Mounted D Board N Board IC1001, RB1001 • Mounted N Board
Beam Current Protector Circuit Check	D Board C930, D917, R921, R932, R933, R935, T901 (FBT) • Mounted D Board N Board IC1001, RB1001 • Mounted N Board

### Terminal name of semiconductors in silk screen printed circuit (\*)

	Device	Printed symbol	Terminal name	Circuit
①	Transistor		Collector Base Emitter	
②	Transistor		Collector Base Emitter	
③	Diode		Cathode Anode	
④	Diode		Cathode Anode (NC)	
⑤	Diode		Cathode Anode (NC)	
⑥	Diode		Common Anode Cathode	
⑦	Diode		Common Anode Cathode	
⑧	Diode		Common Anode Anode	
⑨	Diode		Common Anode Anode	
⑩	Diode		Common Cathode Cathode	
⑪	Diode		Common Cathode Cathode	
⑫	Diode		Anode Anode Cathode Anode	
⑬	Transistor (FET)		Drain Source Gate	
⑭	Transistor (FET)		Drain Source Gate	
⑮	Transistor (FET)		Source Drain Gate	
⑯	Transistor		Emitter Collector Base	
—	Discrete semiconductor			

(Chip semiconductors that are not actually used are included.)

Ver.1.6

(1) Schematic Diagram of A1 Board

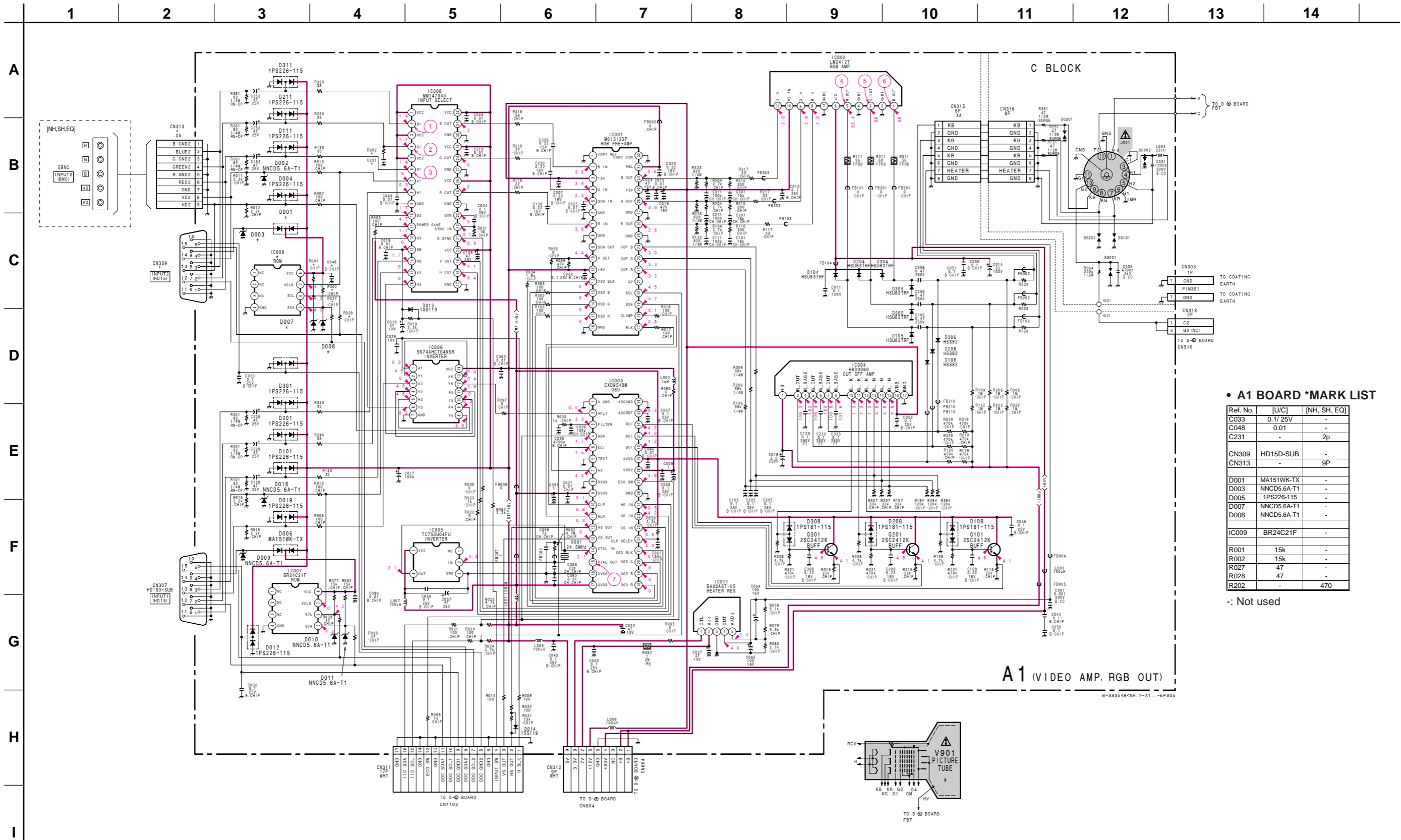

• A1 BOARD \*MARK LIST

Ref. No.	[U/C]	[NH, SH, EQ]
C033	0.1/25V	-
C048	0.01	-
C231	-	2p
CN309	HD15D-SUB	-
CN313	-	9P
D001	MA151WK-TX	-
D003	NNCD5.6A-T1	-
D005	1PS226-115	-
D007	NNCD5.6A-T1	-
D008	NNCD5.6A-T1	-
IC009	BR24C21F	-
R001	15k	-
R002	15k	-
R027	47	-
R028	47	-
R202	-	470

:- Not used

• A BOARD WAVEFORMS

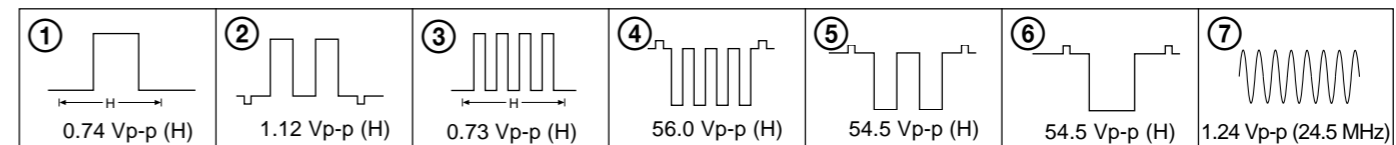

Schematic diagram

**A1** board →

**A1** VIDEO AMP  
RGB OUT

— A1 BOARD —

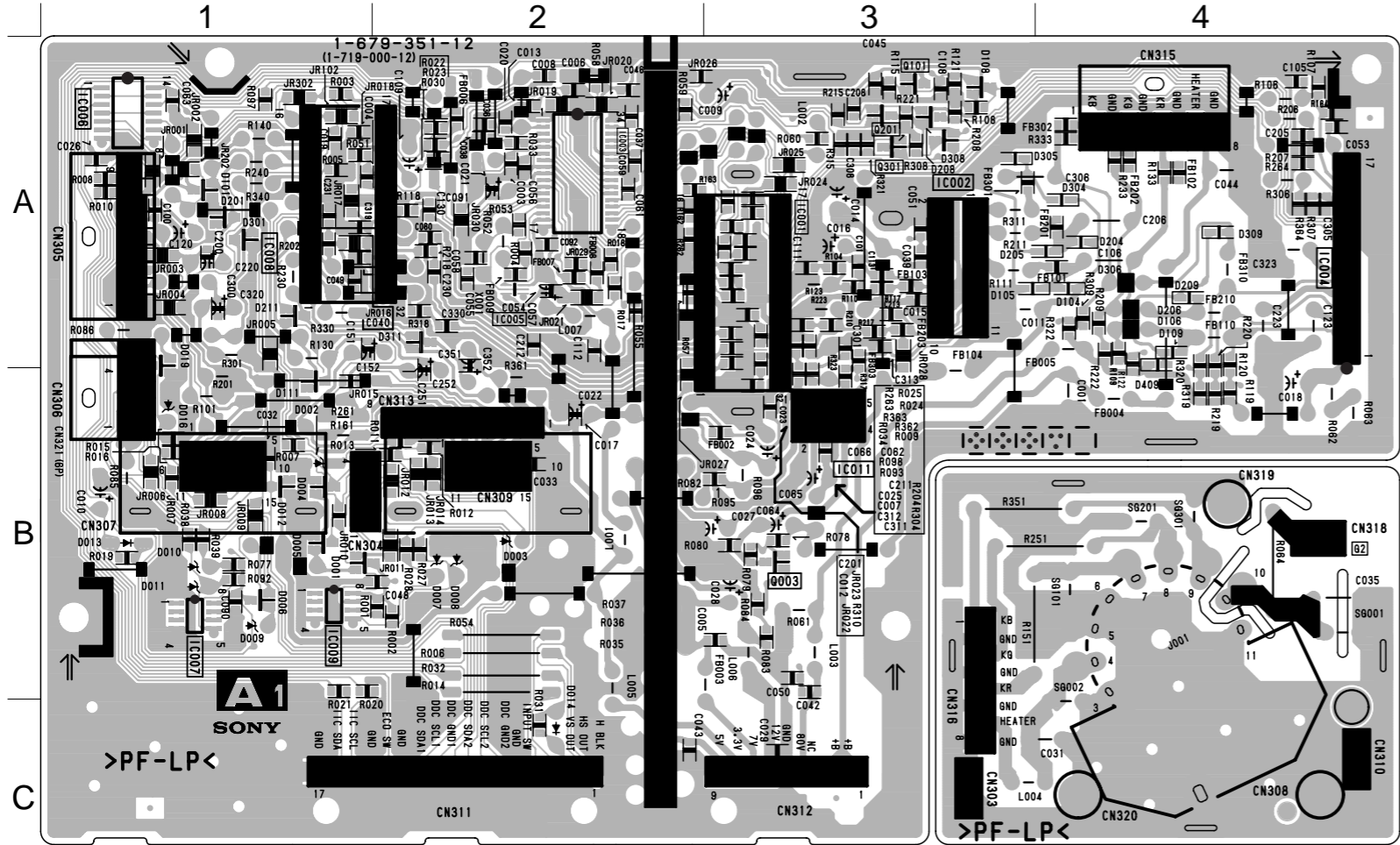

**NOTE:**  
The circuit indicated as left contains high voltage of over 600 Vp-p. Care must be paid to prevent an electric shock in inspection or repairing.

• A1 BOARD  
SEMICONDUCTOR  
LOCATION

IC	
IC001	A-3
IC002	A-3
IC003	A-2
IC004	A-4
IC005	A-2
IC006	A-1
IC007	B-1
IC008	A-1
IC009	B-1
IC011	B-3
TRANSISTOR	
Q101	A-3 *
Q201	A-3 *
Q301	A-3 *
DIODE	
D001	B-1 8
D002	B-1 -
D003	B-2 -
D004	B-1 6
D005	B-1 6
D006	B-1 8
D007	B-2 -
D008	B-2 -
D009	B-1 -
D010	B-1 -
D011	B-1 -
D012	B-1 6
D013	B-1 -
D014	C-2 -
D016	B-1 -
D019	A-1 6
D101	A-1 6
D104	A-4 3
D105	A-3 3
D106	A-4 -
D108	A-3 10
D111	B-1 6
D201	A-1 6
D204	A-4 2
D205	A-3 3
D206	A-4 -
D208	A-3 10
D211	A-1 6
D301	A-1 6
D304	A-4 3
D305	A-3 3
D306	A-4 -
D308	A-3 10
D311	A-2 6
CRYSTAL	
X001	A-2

\*: Refer to Terminal name of semiconductor in silk screen printed circuit (see page 5-10)

(2) Schematic Diagram of US Board (Only NH, SH, EQ models)

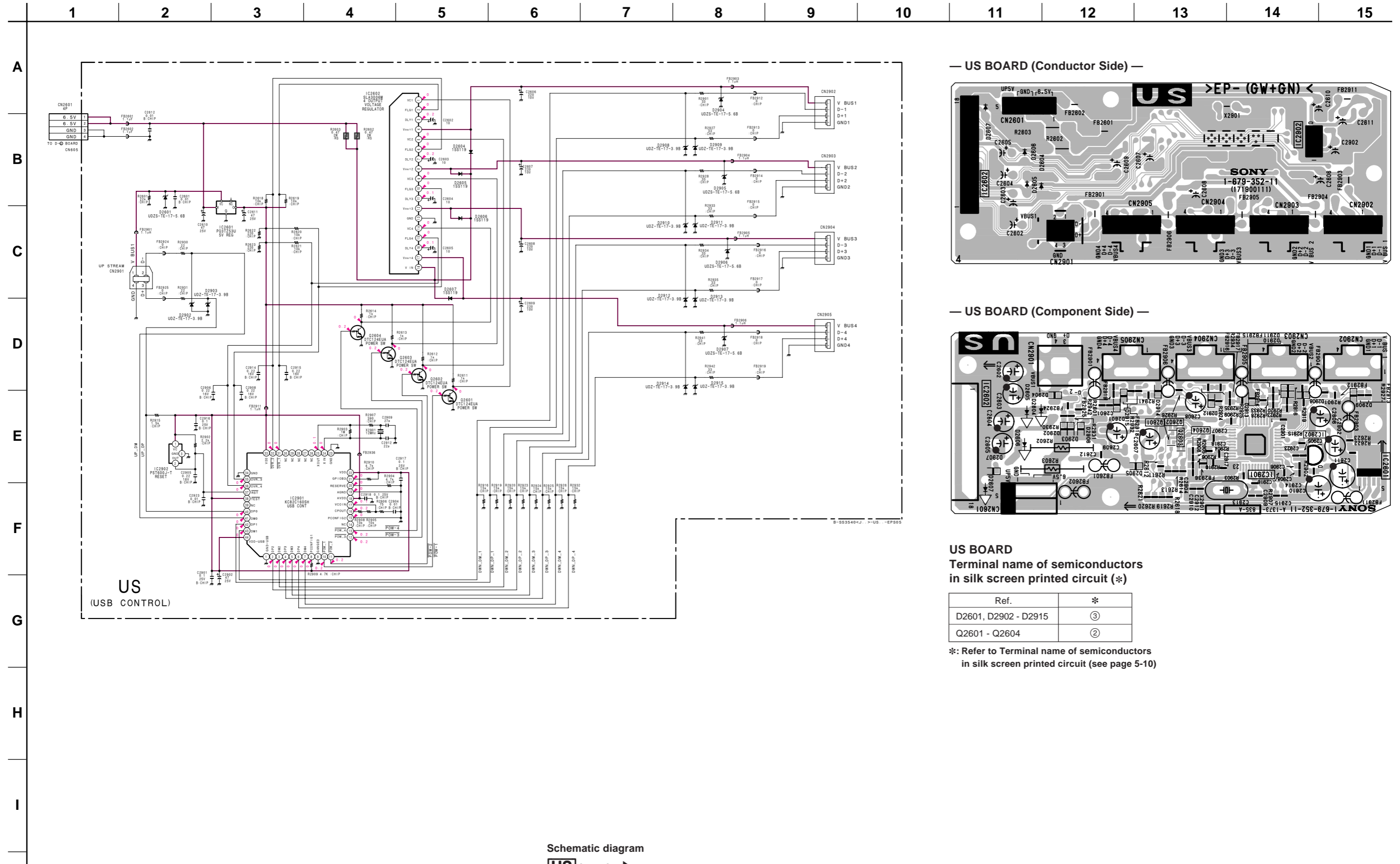

— US BOARD (Conductor Side) —

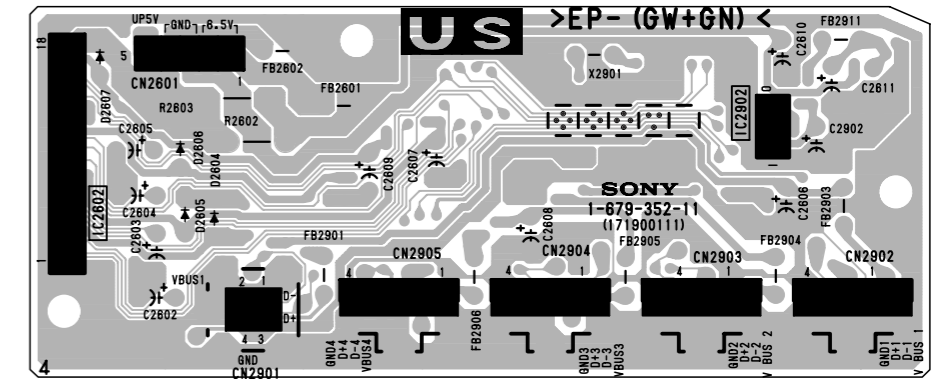

— US BOARD (Component Side) —

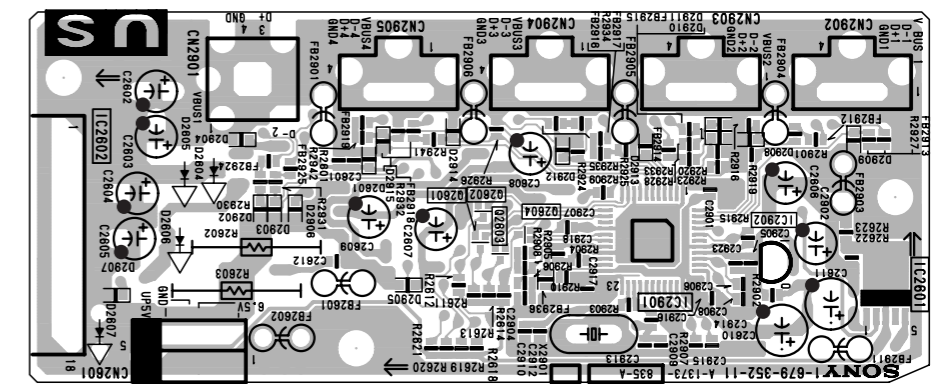

**US BOARD**  
Terminal name of semiconductors  
in silk screen printed circuit (\*):

Ref.	*
D2601, D2902 - D2915	③
Q2601 - Q2604	②

\*: Refer to Terminal name of semiconductors  
in silk screen printed circuit (see page 5-10)

Schematic diagram





(3) Schematic Diagram of DA Board

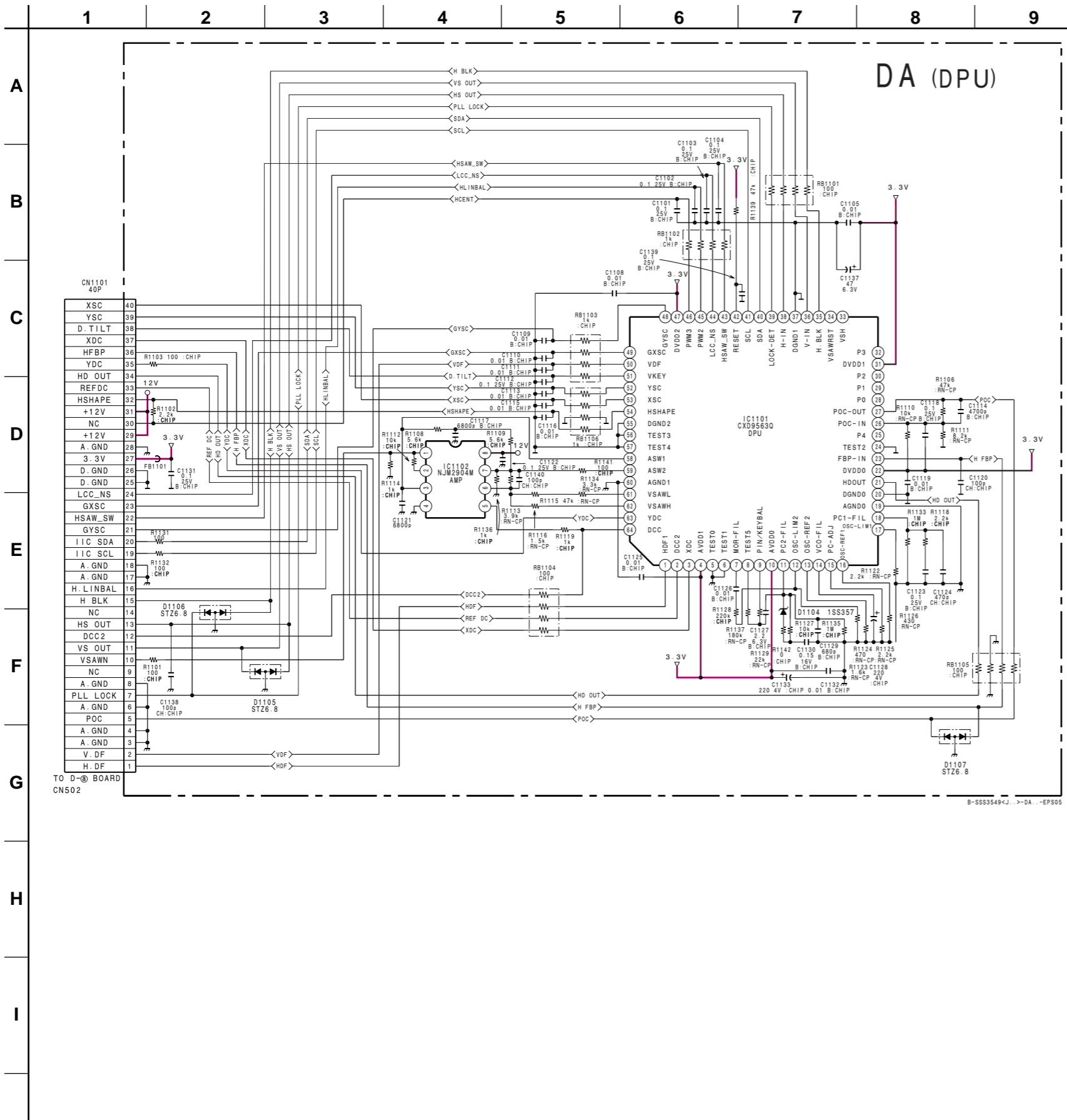

— DA BOARD (Conductor Side) —

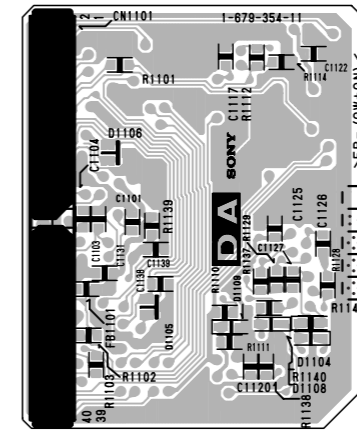

— DA BOARD (Component Side) —

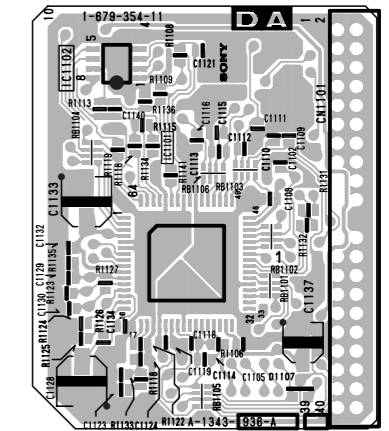

**DA BOARD**  
Terminal name of semiconductors  
in silk screen printed circuit (\*)

Ref.	*
D1104	③
D1105 - D1107	⑩

※: Refer to Terminal name of semiconductors  
in silk screen printed circuit (see page 5-10)

(4) Schematic Diagram of N Board

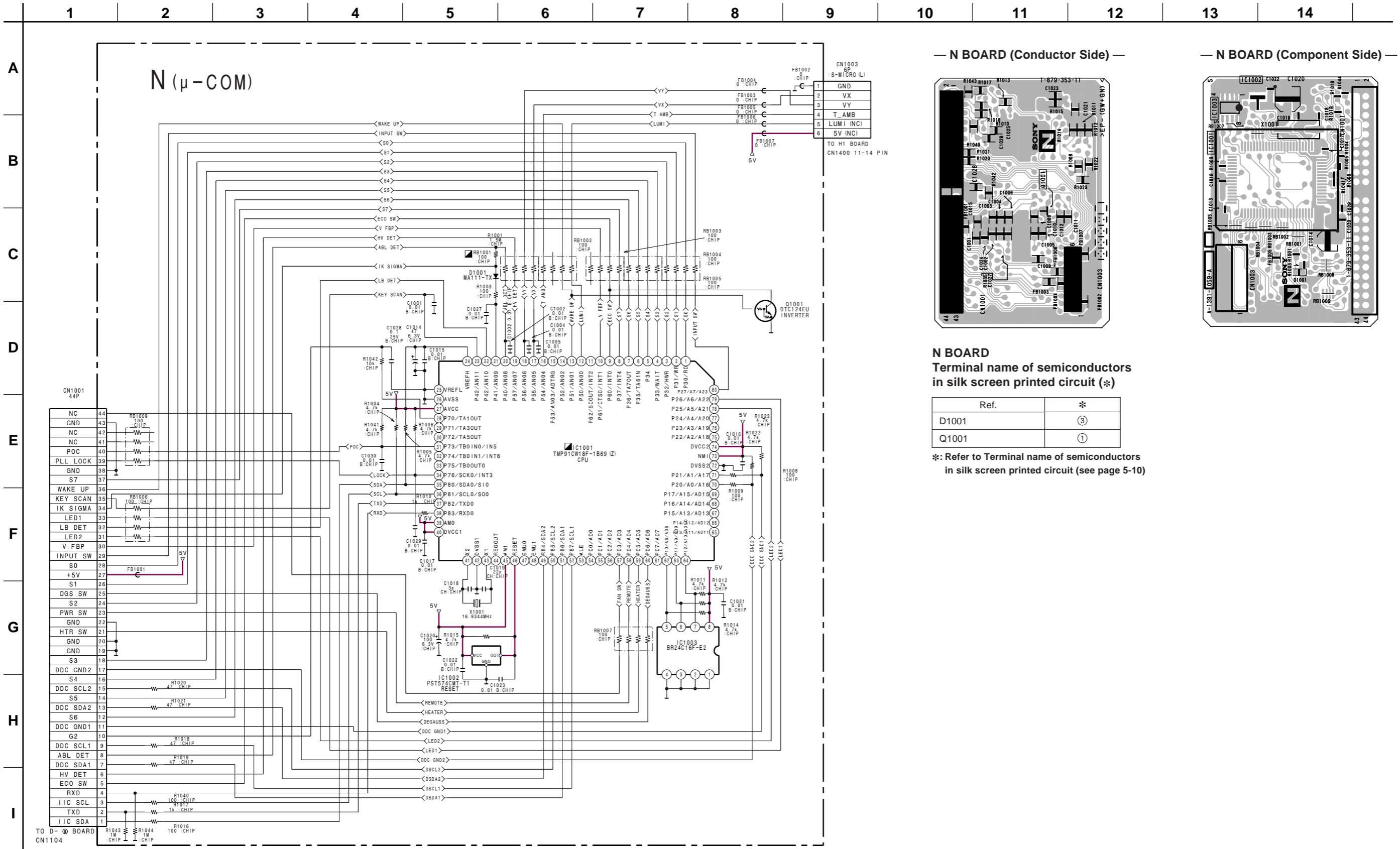

— N BOARD (Conductor Side) —

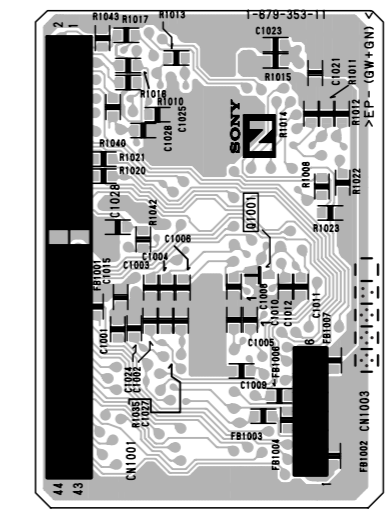

— N BOARD (Component Side) —

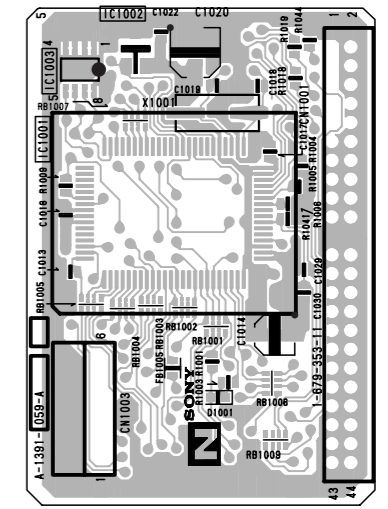

**N BOARD**  
Terminal name of semiconductors in silk screen printed circuit (\*)

Ref.	*
D1001	③
Q1001	①

※: Refer to Terminal name of semiconductors in silk screen printed circuit (see page 5-10)

Schematic diagram  
← DA board

Schematic diagram  
N board →

(5) Schematic Diagrams of D (a, b, c) Board

- Divided circuit diagram  
One sheet of D board circuit diagram is divided into three sheets, each having the code D-Ⓐ to D-Ⓒ. For example, the destination ab1 on the code D-Ⓐ sheet is connected to ab1 on the D-Ⓑ sheet.

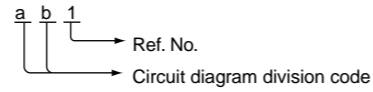

• D-Ⓐ BOARD WAVEFORMS

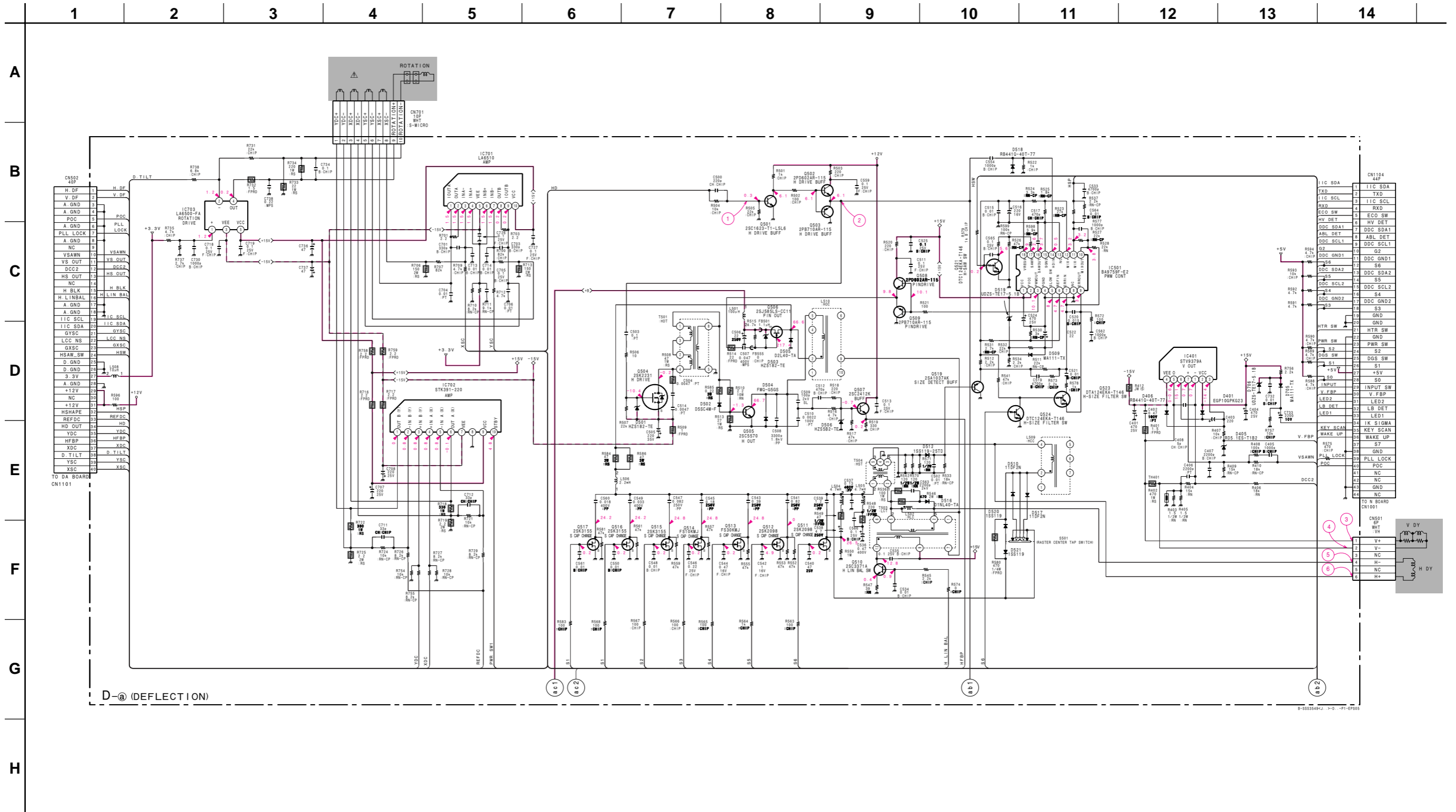
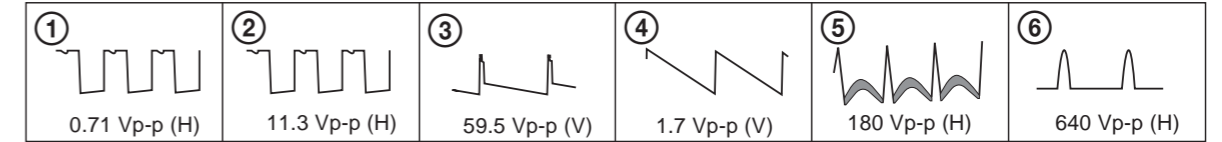

A  
B  
C  
D  
E  
F  
G  
H  
I

D-ⓐ (HV, HDF, VDF)

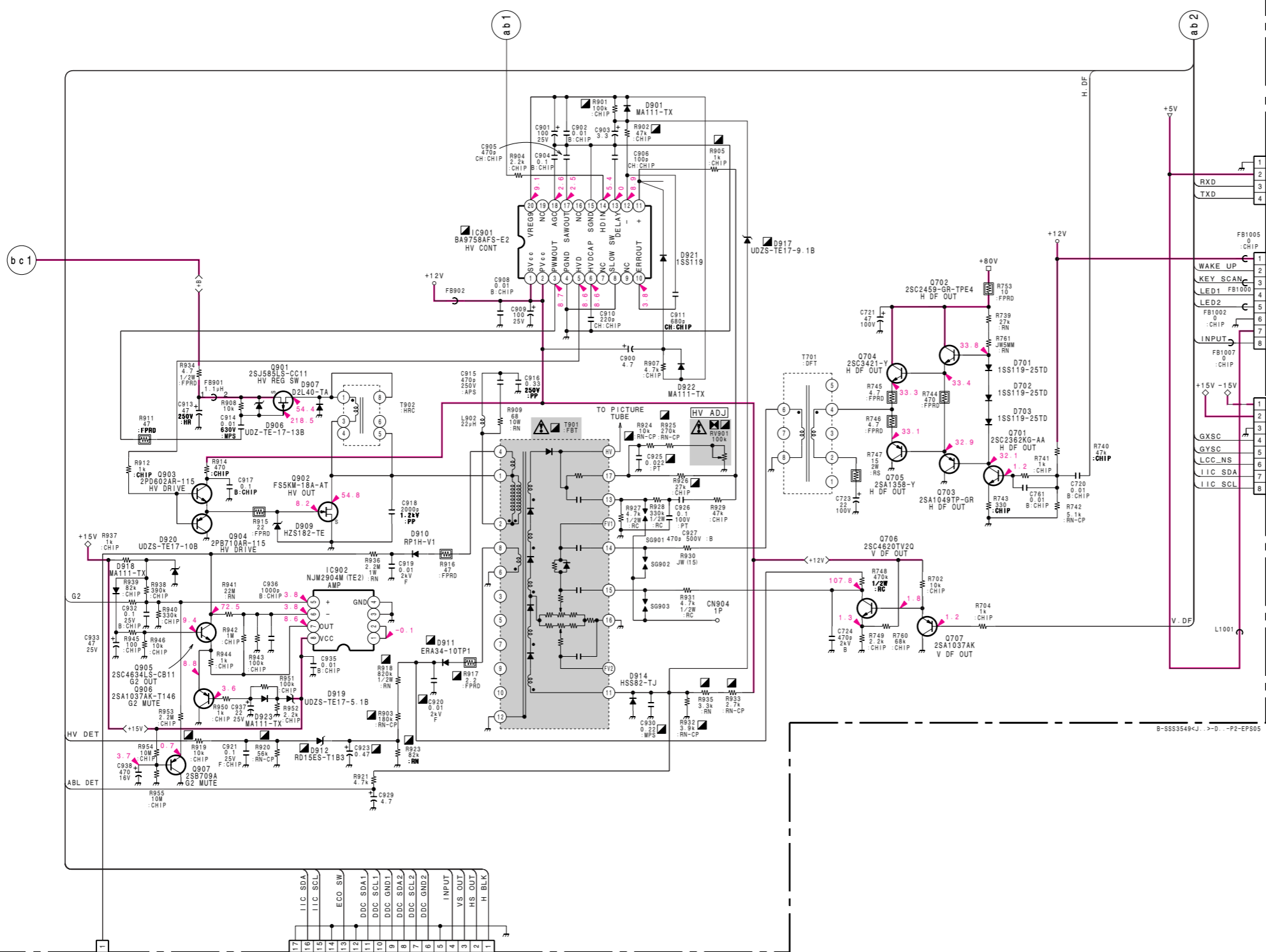

CN1101	
4P	WHT
1	D GND
2	+5V
3	RXD
4	TXD
TO ECS	
CN1103	
8P	WHT
:S-MICRO	
1	+12V
2	WAKE UP
3	KEY SCAN
4	LED1
5	LED2
6	GND
7	+5V
8	INPUT SW
TO H1 BOARD	
CN1400 1-8 PIN	
CN1106	
8P	WHT
1	-15V
2	+15V
3	GND
4	GXSC
5	GXSC
6	LCC_NS
7	IIC_SDA
8	IIC_SCL
TO L2 BOARD	
CN1603	

Schematic diagram  
← D-ⓐ board

TO A1 BOARD  
CN318

GND	17
IIC_SDA	16
IIC_SCL	15
GND	14
ECO_SW	13
DDC_SDA1	12
DDC_SCL1	11
DDC_SDA2	10
DDC_SCL2	9
DDC_SDA2	8
DDC_SCL2	7
DDC_GND2	6
DDC_GND2	5
INPUT_SW	4
VS_OUT	3
HS_OUT	2
H_BLK	1

TO A1 BOARD  
CN311

Schematic diagram  
D-ⓑ board →

A  
B  
C  
D  
E  
F  
G  
H  
I

D-(C) (POWER SUPPLY)

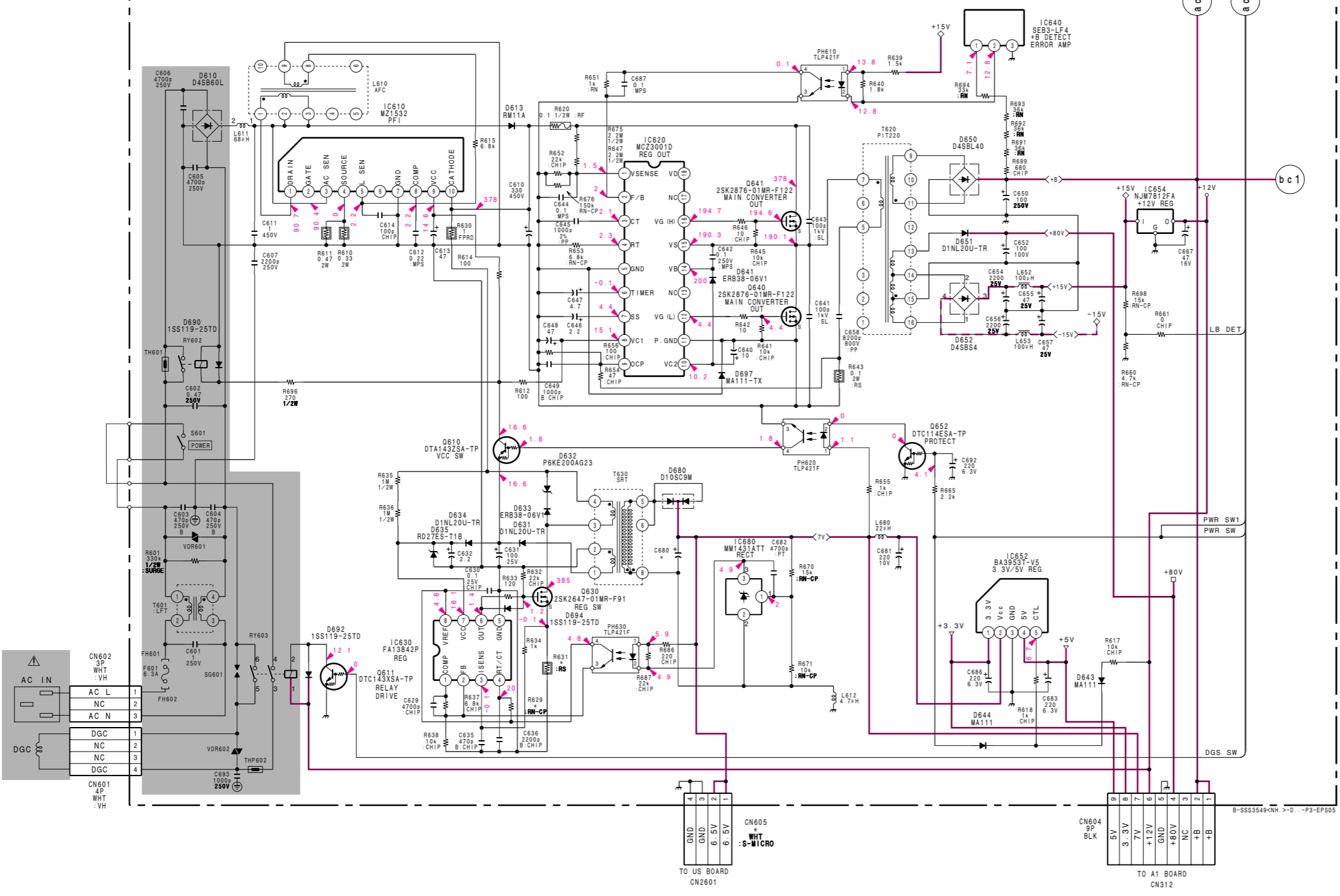

• D-(C) BOARD \*MARK LIST

Ref. No.	INH. SH. EO]	[U/C]
C680	6800/ 10V	4700/ 16V
CN605	4P	-
R629	6.8k	15k
R631	1/2W	1/1W

∴ Not used

**D** DEFLECTION, H DF, V DF  
HV, POWER SUPPLY

— D BOARD —

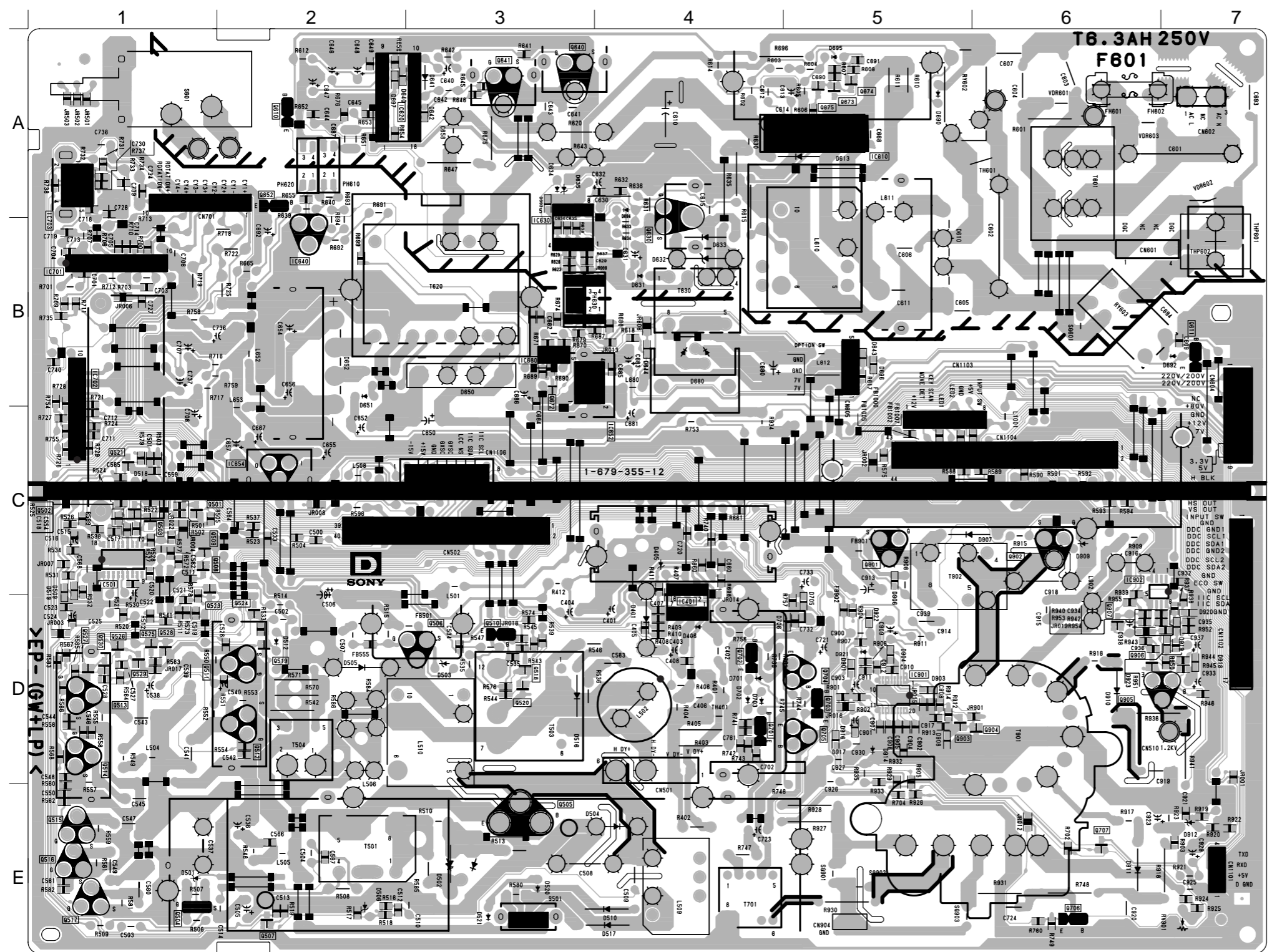

• D BOARD SEMICONDUCTOR LOCATION

IC		DIODE	
IC401	D-4	D401	D-4 *
IC501	C-1	D405	C-4
IC610	A-5	D406	D-4
IC630	B-3	D501	E-1
IC640	B-2	D502	E-3
IC652	B-3	D503	D-3
IC654	C-2	D504	E-4
IC680	B-3	D505	D-2
IC701	B-1	D506	E-2
IC702	B-1	D509	C-1 ③
IC703	A-1	D510	E-4
IC901	D-5	D512	D-2
IC902	C-6	D516	D-3
		D517	E-4
		D518	C-1
		D519	C-1 ③
		D520	E-3
		D521	E-3
		D610	B-5
		D613	A-5
		D631	B-4
		D632	B-4
		D633	B-4
		D634	A-3
		D635	A-3
		D641	A-3
		D643	B-5 ③
		D644	B-4 ③
		D650	B-3
		D651	B-2
		D652	B-2
		D680	B-4
		D690	A-5
		D692	B-7
		D694	A-4
		D697	A-2 ③
		D701	D-4
		D702	D-4
		D703	D-4
		D705	C-5 ③
		D706	D-4 ③
		D901	D-5 ③
		D906	C-5 ③
		D907	C-5
		D909	C-6
		D910	D-6
		D911	E-6
		D912	E-7
		D914	D-5
		D917	D-5 ③
		D918	D-7 ③
		D919	D-7 ③
		D920	D-7 ③
		D921	D-5
		D922	D-5 ③
		D923	D-7 ③
			VARIABLE RESISTOR
		RV901	E-7

**NOTE:**  
The circuit indicated as left contains high voltage of over 600 Vp-p. Care must be paid to prevent an electric shock in inspection or repairing.

※: Refer to Terminal name of semiconductors in silk screen printed circuit (see page 5-10)

Schematic diagram  
← **D**-**©** board

(6) Schematic Diagram of H1 Board

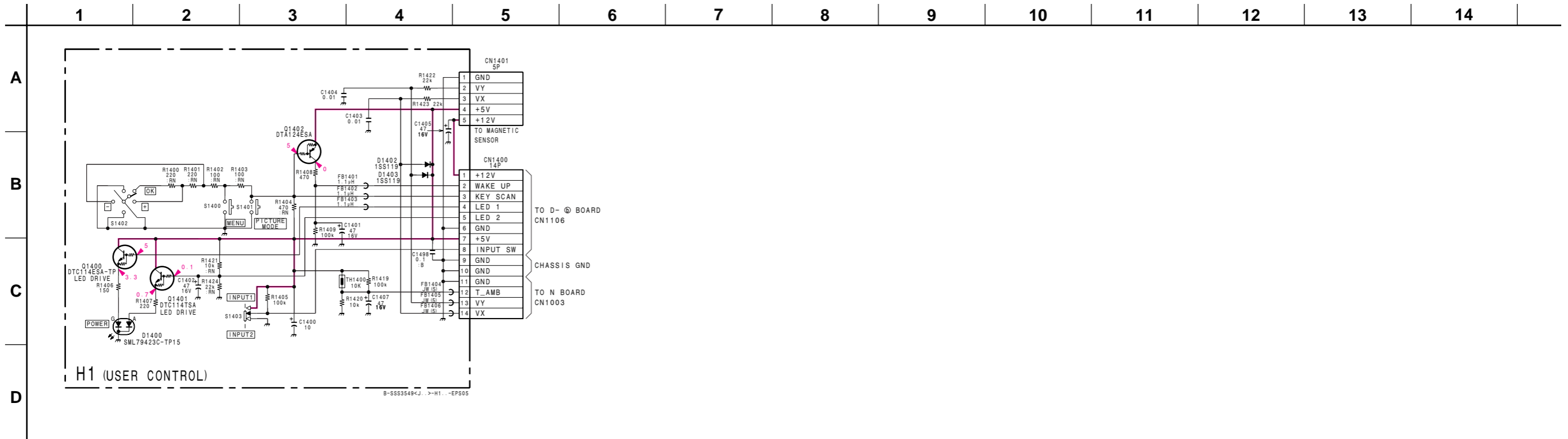

**H1** [ USER CONTROL ]

- H1 BOARD -

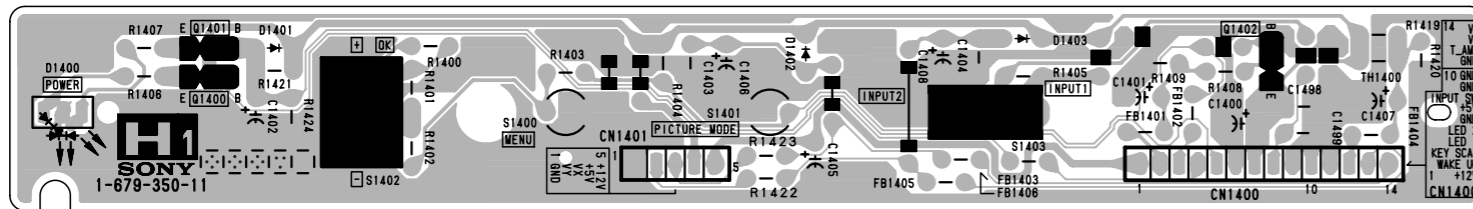

(7) Schematic Diagram of L2 Board

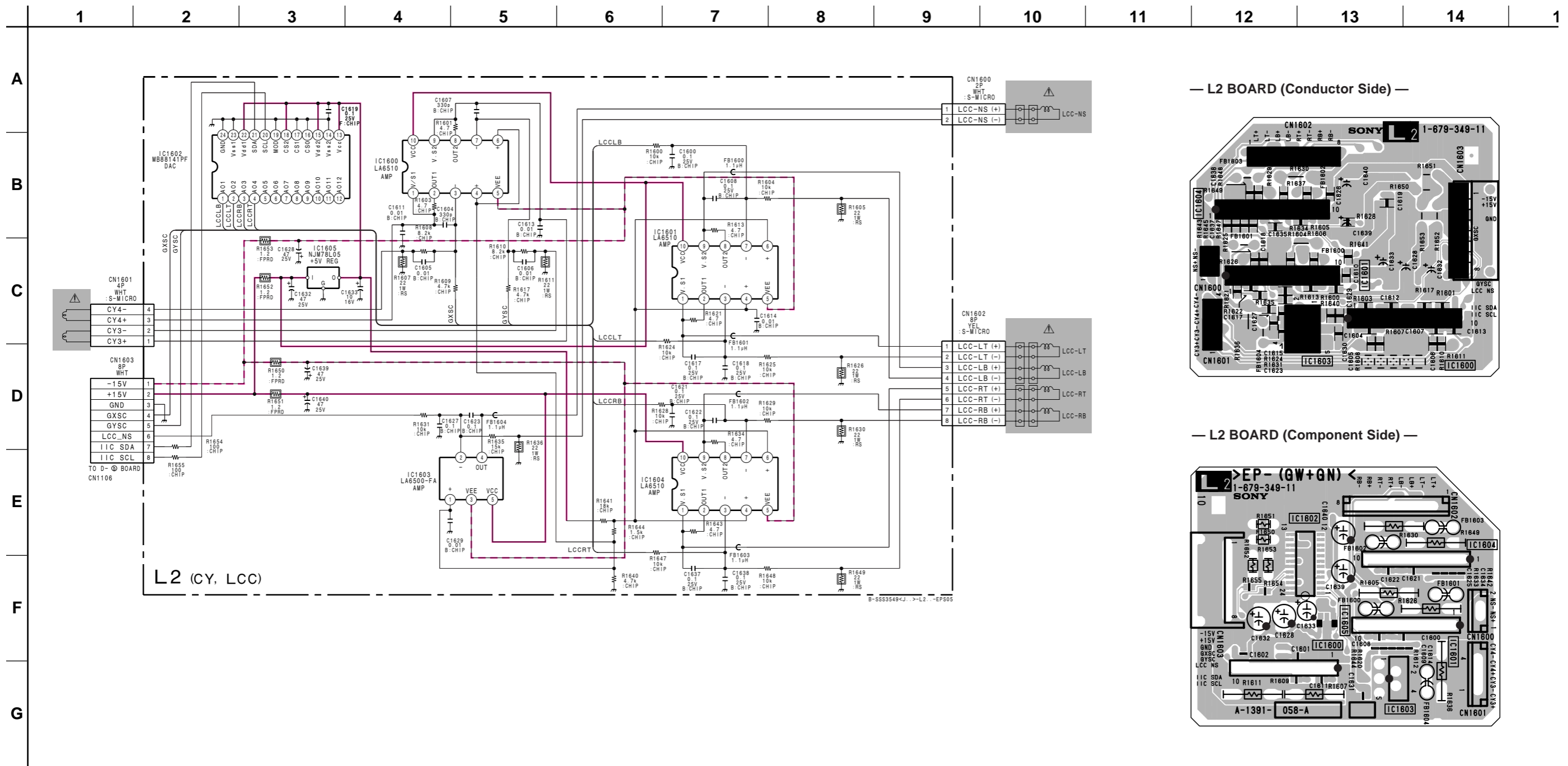

— L2 BOARD (Conductor Side) —

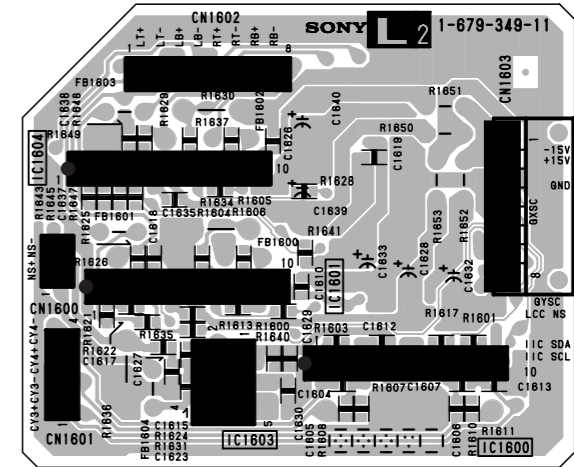

— L2 BOARD (Component Side) —

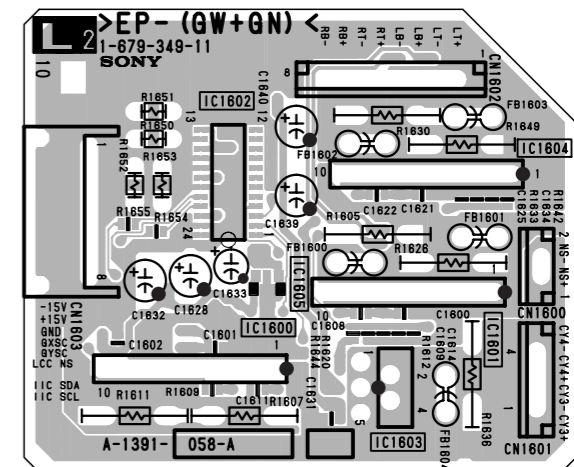



## 5-5. SEMICONDUCTORS

**BA00AST-V5  
LA6500-FA**

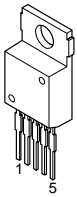

**CXD9563Q**

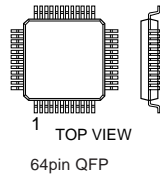

**LM2412AT  
LM2412T**

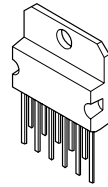

**PQ3T253U**

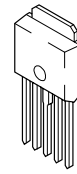

**TMP91PW18F-1A22 (Z)**

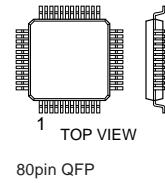

**BA3953T-V5**

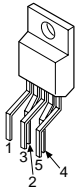

**FA13842P**



**MCZ3001D**



**PST574CMT-T1**

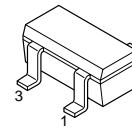

**DTA124EKA-T146  
DTC124EK  
DTC124EKA-T146  
2PB710AR-115  
2PD602AR-115  
2SA1037AK-T146-QR  
2SA1037AK-T146-R  
2SA1162-G  
2SB709A-QRS-TX  
2SC1623-L5L6  
2SC2412K-T-146-QR**

**BA9758AFS-E2  
BA9758FS-E2**

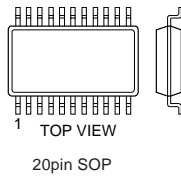

**H8D3060**

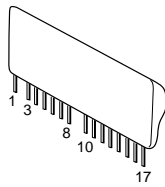

**MM1431ATT**

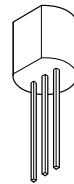

**PST600J-T**

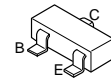
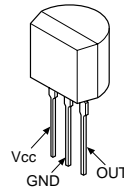

**DTA124ESA-TP  
DTC114ESA  
DTC114ESA-TP  
DTC143XSA  
DTC143XSA-TP  
2SC2459-GR-TPE4  
2SC2784**

**BA9759F-E2**

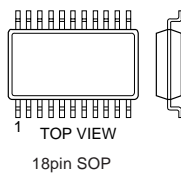

**KC82C160SH**

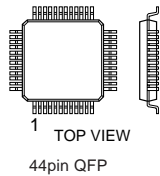

**MZ1532**

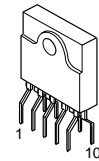

**SLA3006M (LF874)**

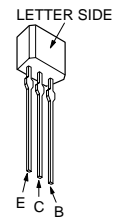
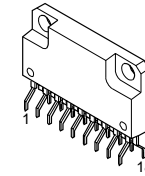

**BR24C16F-E2  
BR24C21F-E2  
NJM2904M  
NJM2904M(TE2)**

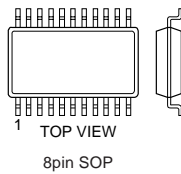

**LA6510**

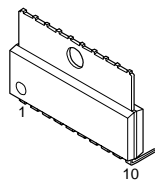

**M61312SP  
MM1470AD**

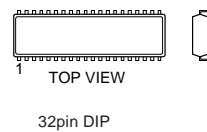

**SN74AHCT04NSR**

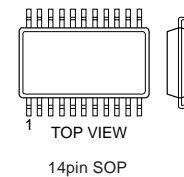

**DTA143ZSA-TP  
DTC114TSA  
DTC114TSA-TP  
2SA1049-GR  
2SA1049TP-GR**

**CXD9548M**

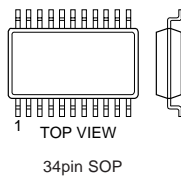

**LA78040**

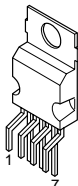

**NJM7812FA  
SEB3-LF4**

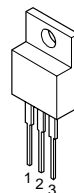

**STK391-120**

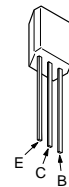
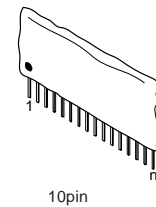

**DTC124EUA-T106  
DTC124EUT106**

**LA6500-FA**



**TC7SU04FU (TE85R)**

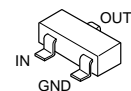
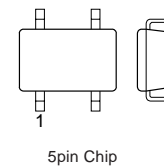

FS10KMJ-3-AZ  
 FS30KMJ-3-AZ  
 FS5KM-18A-AT  
 2SJ585LS-CB11  
 2SK2098-01MR-F119  
 2SK2876-01MR-F122  
 2SK3155-01  
 2SK3332

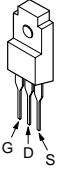

2SA1358-Y  
 2SC3421-Y

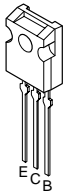

2SC2362K-G  
 2SC2362KG-AA



2SC4620TV2Q  
 2SD774-34  
 2SD774-T-34

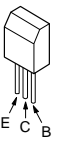

2SC4634LS-CB11

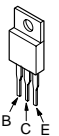

2SC5682-CC  
 2SJ585LS-CC11

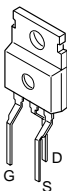

2SK2231

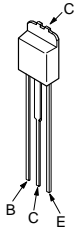

2SK2647-01MR-F91

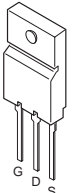

DTZ10B  
 DTZ13B  
 MA111-(K8).S0  
 MA111-TX  
 UDZ-TE-17-13B  
 UDZ-TE-17-3.9B  
 UDZS-TE17-10B  
 UDZS-TE17-5.1B  
 UDZS-TE17-5.6B  
 UDZS-TE17-9.1B  
 1SS357-TPH3

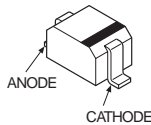

D1NL20U-TR  
 D1NL20U-TR2  
 ERA34-10TP1  
 ERB38-06V1  
 HSS82-TJ  
 HZS5B2-TE  
 NNCD5.6A-T1  
 P6KE200AG23  
 RGP02-20EL-6394  
 RP1H-V1  
 11DF2N-TA2B2

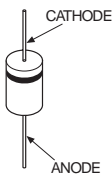

D10SC9M

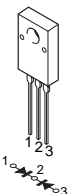

D3S4M  
 EGP10D  
 EGP10GPKG23  
 ERC81-004

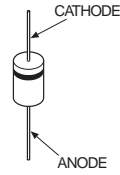

D4SB60L  
 D4SBL40  
 D4SBS4  
 D4SBS4-F

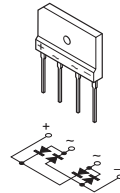

HSU83TRF

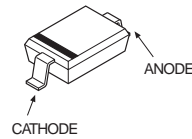

HZS182-TE  
 RB441Q-40T-77  
 RD15ES-B3  
 RD15ES-T1B3  
 RD18ESB  
 RD27ES-B2  
 RD27ES-T1B  
 RD5.1ES-T1B2  
 RD5.1ESB2  
 RD5.6ESB2  
 1PS119-25

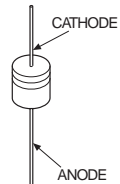

MA151WK-TX  
 1SS184

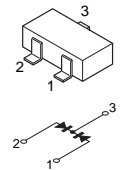

MA8039

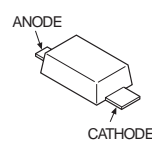

RM11A  
 RM11C

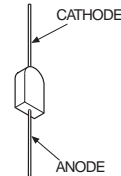

SML79423C-TP15

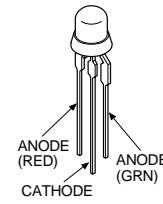

TLP421F (D4-SONY)

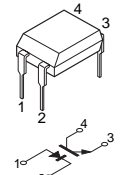

1PS181-115

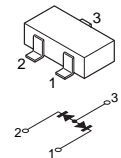

1PS226-115

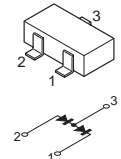

1SS376TE-17

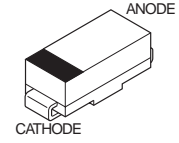

5TUZ52C (SONY1)

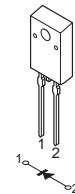

## SECTION 6 EXPLODED VIEWS

- Items with no part number and no description are not stocked because they are seldom required for routine service.
- The construction parts of an assembled part are indicated with a collation number in the remark column.
- Items marked " \* " are not stocked since they are seldom required for routine service. Some delay should be anticipated when ordering these items.

The components identified  $\triangle$  marked are critical for safety.  
Replace only with the part number specified.

Les composants identifiés par la marque  $\triangle$  sont critiques pour la sécurité.  
Ne les remplacer que par une pièce portant le numéro spécifié.

### 6-1. CHASSIS

- 7-685-881-09 +BVTT 4X8
- 7-685-646-79 +BVTP 3X8
- 7-685-647-79 +BVTP 3X10
- 7-685-663-71 +BVTP 4X16
- ▲ 7-685-880-09 +BVTT 4X6

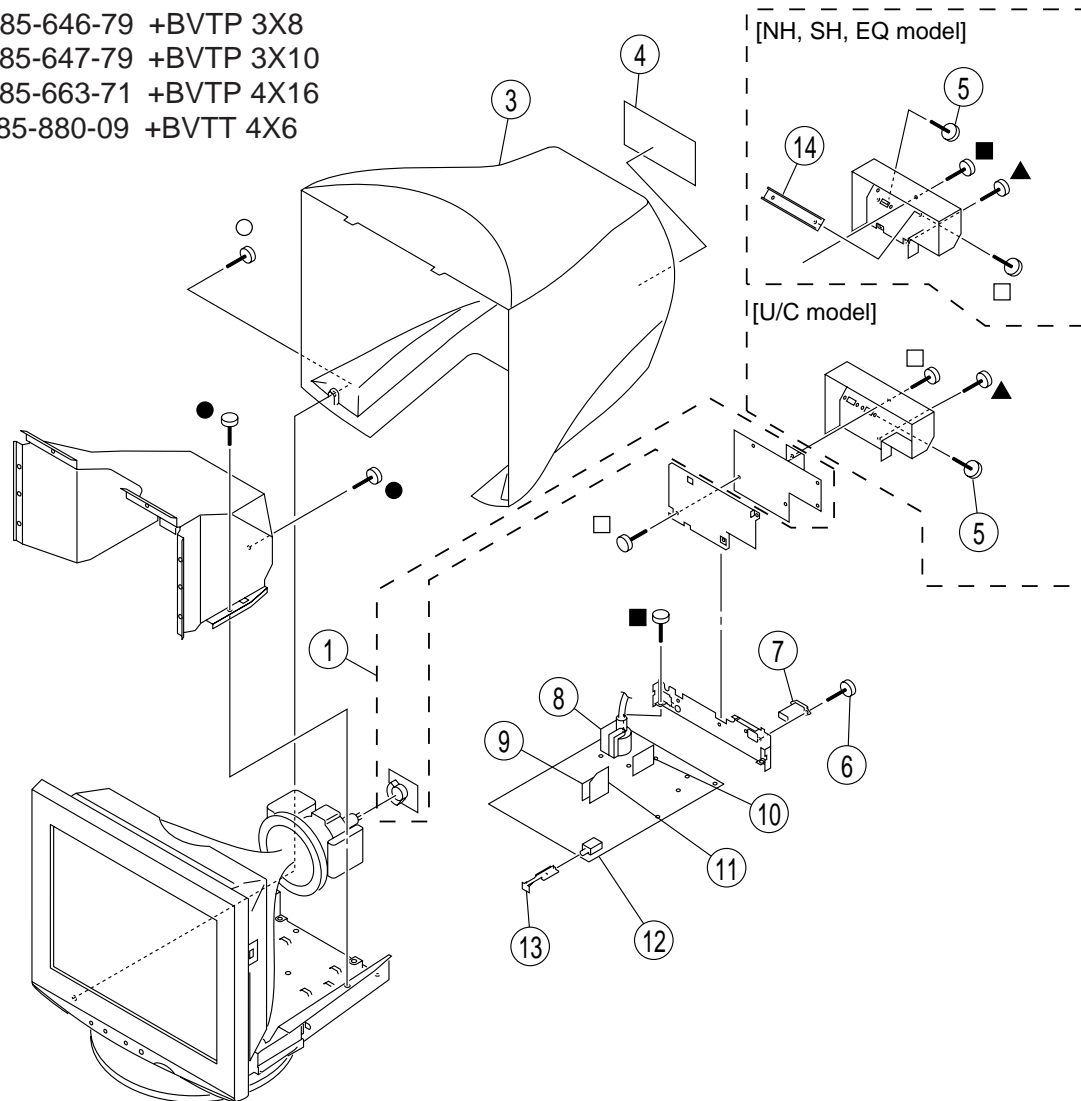

REF.NO.	PART NO.	DESCRIPTION	REMARK	REF.NO.	PART NO.	DESCRIPTION	REMARK
1	* 8-933-472-00	A1 BOARD, COMPLETE [U/C]		7	$\triangle$ 1-251-382-31	INLET, AC (WITH NOISE FILTER)	
1	* 8-933-488-00	A1 BOARD, COMPLETE [NH, SH, EQ]		8	$\triangle$ 1-453-359-11	TRANSFORMER ASSY, FLYBACK (NX-4702/KM7E)	
	4-080-941-01	CABINET [U/C]		9	* 8-933-476-00	DA BOARD, COMPLETE	
3	4-079-817-21	CABINET [NH, SH, EQ]		10	* 8-933-479-00	N BOARD, COMPLETE	
4	* 4-081-653-01	LABEL, INFORMATION [U/C]		11	* 8-933-481-00	L2 BOARD, COMPLETE	
4	* 4-081-624-01	LABEL, INFORMATION [NH]		12	* 8-933-487-00	D BOARD, COMPLETE [U/C]	
4	* 4-081-625-01	LABEL, INFORMATION [SH]		12	* 8-933-474-00	D BOARD, COMPLETE [NH, SH, EQ]	
4	* 4-081-625-11	LABEL, INFORMATION [EQ]		13	4-079-799-01	BAR, EXTENSION	
5	* 4-635-966-01	SCREW (HEX)		14	1-694-763-11	TERMINAL BOARD ASSY, INPUT/OUT [NH, SH, EQ]	
6	4-052-345-01	SCREW, (3X8) (+K), TAPPING					

6-2. PICTURE TUBE

- 7-685-881-09 +BVTT 4X8
- 7-685-647-79 +BVTP 3X10
- 7-685-663-71 +BVTP 4X16
- △ 7-685-872-09 +BVTT 3X8

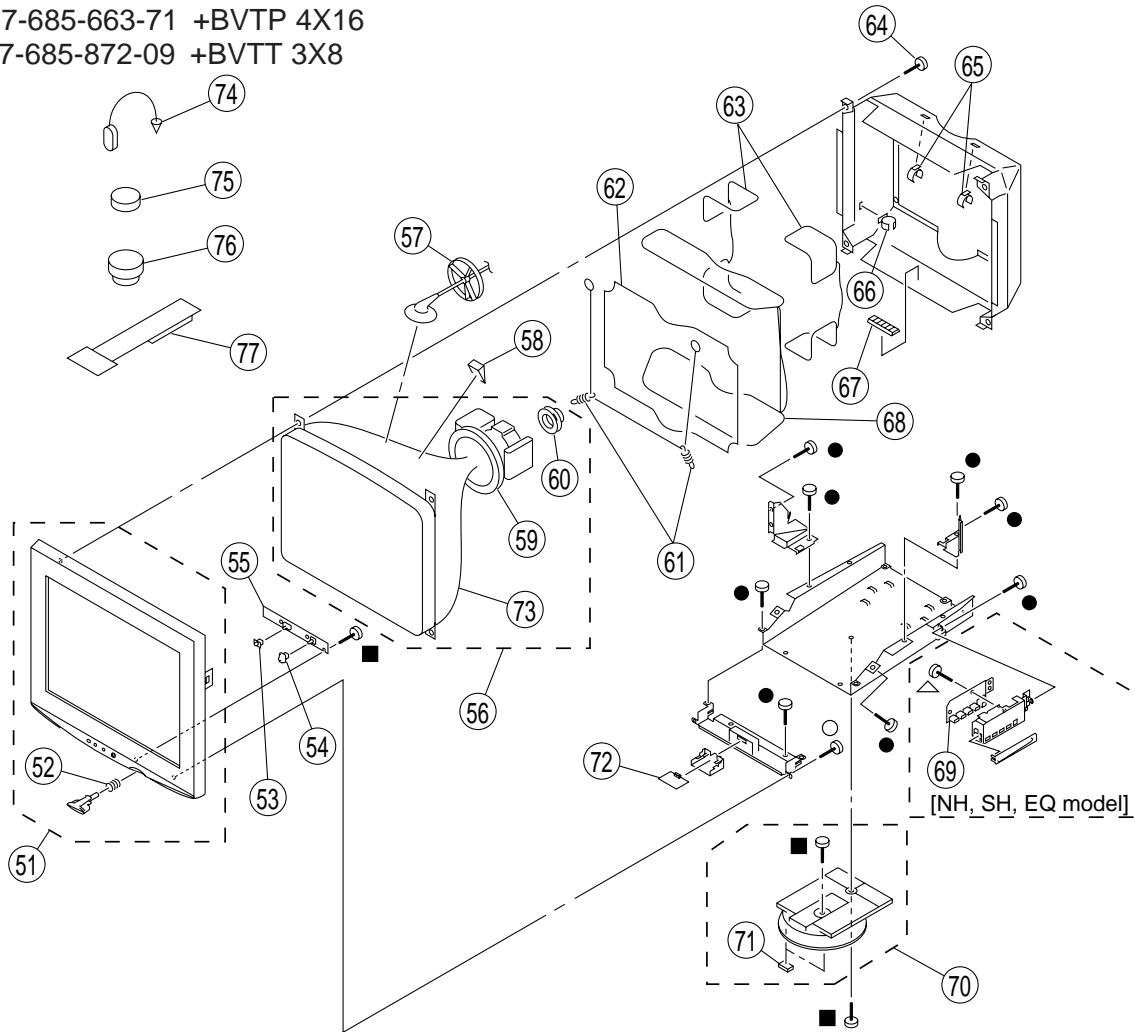

The components identified △ marked are critical for safety. Replace only with the part number specified.

Les composants identifiés par la marque △ sont critiques pour la sécurité. Ne les remplacer que par une pièce portant le numéro spécifié.

REF.NO.	PART NO.	DESCRIPTION	REMARK	REF.NO.	PART NO.	DESCRIPTION	REMARK
51	X-4038-405-1	BEZEL ASSY	52	65	4-041-021-02	HOLDER, DEGAUSE COIL	
52	4-036-405-01	SPRING COMPRESSION		66	4-071-175-01	HOLDER, DGC	
53	4-079-773-01	BUTTON, INPUT SELECTOR		67	4-062-670-01	SPACER, PICTURE TUBE	
54	4-079-788-01	STICK, JOY		68	△ 1-419-838-11	COIL, DEGAUSSING	
55	* 8-933-477-00	H1 BOARD, COMPLETE		69	* 8-933-480-00	US BOARD, COMPLETE [NH, SH, EQ]	
56	8-734-018-06	ITC ASSY (21TKD-R1) [U/C, NH]	59, 60, 73	70	X-4038-402-1	STAND ASSY	71
56	pending	ITC ASSY [SH, EQ]	59, 60, 73	71	* 4-061-996-01	CUSHION	
57	3-704-372-01	HOLDER, HV CABLE		72	△ 8-610-158-71	SENSOR, MAGNETIC MIU-221D	
58	2-162-100-21	SPACER, DY		73	△ 8-738-839-05	PICTURE TUBE 21TKD [U/C, NH]	
59	△ 8-451-519-11	DEFLECTION YOKE Y21TKN		73	△ 8-738-847-05	PICTURE TUBE 21TKD (SOUTH)	[SH, EQ]
60	△ 1-452-923-51	NECK ASSEMBLY					
61	* 4-047-316-01	SPRING, EXTENSION		74	4-308-870-00	CLIP, LEAD WIRE	
62	△ 1-419-130-21	COIL, LANDING CORRECTION		75	1-452-032-00	MAGNET, DISK; 10mmφ	
63	△ 1-419-129-21	COIL, LANDING CORRECTION		76	1-452-094-00	MAGNET, ROTATABLE DISK; 15mmφ	
64	4-365-808-01	SCREW (5), TAPPING		77	4-051-736-21	PIECE A (90), CORRECT	

6-3. PACKING MATERIALS

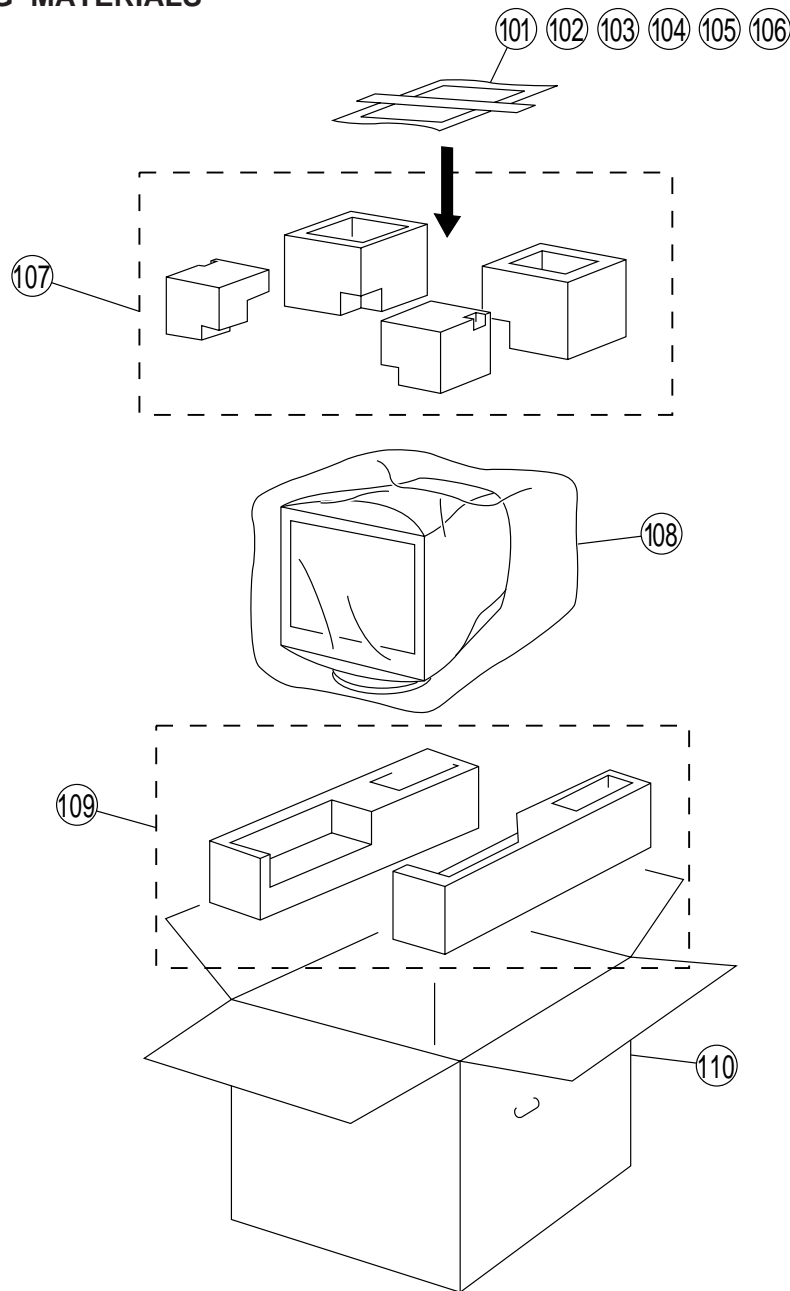

The components identified  $\Delta$  marked are critical for safety. Replace only with the part number specified.

Les composants identifiés par la marque  $\Delta$  sont critiques pour la sécurité. Ne les remplacer que par une pièce portant le numéro spécifié.

REF.NO.	PART NO.	DESCRIPTION	REMARK	REF.NO.	PART NO.	DESCRIPTION	REMARK
101	$\Delta$ 1-782-783-31	CORD SET, POWER [U/C]		107	* 4-078-355-01	CUSHION (UPPER) (ASSY) [U/C, NH]	
101	$\Delta$ 1-782-784-21	CORD SET, POWER [NH, EQ]		107	* 4-081-714-01	CUSHION (UPPER) (ASSY) [SH, EQ]	
101	$\Delta$ 1-782-785-11	CORD SET, POWER [SH]		108	* 4-041-927-31	BAG, POLYETHYLENE	
102	$\Delta$ 1-785-512-31	CONNECTOR, D SUB [NH, SH, EQ]		109	* 4-078-356-01	CUSHION (LOWER) (ASSY) [U/C, NH]	
103	$\Delta$ 1-790-081-21	CABLE, USB [NH, SH, EQ]		109	* 4-081-715-01	CUSHION (LOWER) (ASSY) [SH, EQ]	
104	4-079-771-21	MANUAL, INSTRUCTION [U/C]		110	* 4-078-363-01	INDIVIDUAL CARTON [U/C]	
104	4-079-771-51	MANUAL, INSTRUCTION [NH]		110	* 4-081-974-01	INDIVIDUAL CARTON [NH]	
104	4-079-771-61	MANUAL, INSTRUCTION [SH, EQ]		110	* 4-081-713-01	INDIVIDUAL CARTON [SH, EQ]	
106	$\Delta$ 1-757-496-11	CABLE ASSY (15P SUB X2 CONNECTOR)					

# SECTION 7 ELECTRICAL PARTS LIST

A1

**NOTE:**

- The components identified  $\Delta$  marked are critical for safety.  
Replace only with the part number specified.
- Les composants identifiés par la marque  $\Delta$  sont critiques pour la sécurité.  
Ne les remplacer que par une pièce portant le numéro spécifié.
- When indicating parts by reference number, please include the board name.

The components identified by  $\boxtimes$  in this manual have been carefully factory-selected for each set in order to satisfy regulations regarding X-ray radiation. Should replacement be required, replace only with the value originally used.

• All variable and adjustable resistors have characteristic curve B, unless otherwise noted.

• Items marked " \* " are not stocked since they are seldom required for routine service. Some delay should be anticipated when ordering these items.

**RESISTORS**  
 • All resistors are in ohms  
 • F : nonflammable

REF.NO.	PART NO.	DESCRIPTION	REMARK	REF.NO.	PART NO.	DESCRIPTION	REMARK
A1 BOARD, COMPLETE *****							
	4-382-854-11	SCREW (3X10), P, SW (+) (IC002)		C048	1-163-021-91	CERAMIC CHIP 0.01 $\mu$ F	10% 50V [U/C]
<CAPACITOR>				C049	1-163-021-91	CERAMIC CHIP 0.01 $\mu$ F	10% 50V
C001	1-162-318-11	CERAMIC 0.001 $\mu$ F	10% 500V	C050	1-115-339-11	CERAMIC CHIP 0.1 $\mu$ F	10% 50V
C004	1-164-004-11	CERAMIC CHIP 0.1 $\mu$ F	10% 25V	C051	1-115-339-11	CERAMIC CHIP 0.1 $\mu$ F	10% 50V
C005	1-164-004-11	CERAMIC CHIP 0.1 $\mu$ F	10% 25V	C053	1-164-004-11	CERAMIC CHIP 0.1 $\mu$ F	10% 25V
C007	1-164-489-11	CERAMIC CHIP 0.22 $\mu$ F	10% 16V	C054	1-164-004-11	CERAMIC CHIP 0.1 $\mu$ F	10% 25V
C009	1-126-960-11	ELECT 1 $\mu$ F	20% 50V	C055	1-163-235-11	CERAMIC CHIP 22pF	5% 50V
C010	1-104-664-11	ELECT 47 $\mu$ F	20% 10V	C057	1-104-664-11	ELECT 47 $\mu$ F	20% 25V
C011	1-106-220-00	MYLAR 0.1 $\mu$ F	10% 100V	C058	1-163-224-11	CERAMIC CHIP 7pF	0.25pF 50V
C012	1-164-489-11	CERAMIC CHIP 0.22 $\mu$ F	10% 16V	C059	1-164-004-11	CERAMIC CHIP 0.1 $\mu$ F	10% 25V
C014	1-107-930-91	ELECT 22 $\mu$ F	20% 100V	C061	1-163-255-11	CERAMIC CHIP 150pF	5% 50V
C015	1-164-004-11	CERAMIC CHIP 0.1 $\mu$ F	10% 25V	C062	1-164-004-11	CERAMIC CHIP 0.1 $\mu$ F	10% 25V
C016	1-128-528-11	ELECT 470 $\mu$ F	20% 16V	C063	1-163-021-91	CERAMIC CHIP 0.01 $\mu$ F	10% 50V
C017	1-163-251-11	CERAMIC CHIP 100pF	5% 50V	C064	1-126-382-11	ELECT 100 $\mu$ F	20% 16V
C018	1-107-649-11	ELECT 2.2 $\mu$ F	20% 250V	C065	1-107-882-91	ELECT 100 $\mu$ F	20% 16V
C019	1-163-021-91	CERAMIC CHIP 0.01 $\mu$ F	10% 50V	C090	1-163-021-91	CERAMIC CHIP 0.01 $\mu$ F	10% 50V
C021	1-163-021-91	CERAMIC CHIP 0.01 $\mu$ F	10% 50V	C091	1-126-960-11	ELECT 1 $\mu$ F	20% 50V
C022	1-104-664-11	ELECT 47 $\mu$ F	20% 10V	C092	1-163-021-91	CERAMIC CHIP 0.01 $\mu$ F	10% 50V
C023	1-164-489-11	CERAMIC CHIP 0.22 $\mu$ F	10% 16V	C101	1-163-233-11	CERAMIC CHIP 18pF	5% 50V
C024	1-107-909-11	ELECT 47 $\mu$ F	20% 16V	C105	1-164-004-11	CERAMIC CHIP 0.1 $\mu$ F	10% 25V
C025	1-163-021-91	CERAMIC CHIP 0.01 $\mu$ F	10% 50V	C106	1-117-450-11	MYLAR 0.47 $\mu$ F	10% 250V
C026	1-163-227-11	CERAMIC CHIP 10pF	0.5pF 50V	C108	1-164-489-11	CERAMIC CHIP 0.22 $\mu$ F	10% 16V
C027	1-126-785-11	ELECT 47 $\mu$ F	20% 10V	C109	1-104-664-11	ELECT 47 $\mu$ F	20% 25V
C029	1-164-489-11	CERAMIC CHIP 0.22 $\mu$ F	10% 16V	C111	1-163-251-11	CERAMIC CHIP 100pF	5% 50V
C031	1-162-318-11	CERAMIC 0.001 $\mu$ F	10% 500V	C120	1-104-664-11	ELECT 47 $\mu$ F	20% 25V
C032	1-164-004-11	CERAMIC CHIP 0.1 $\mu$ F	10% 25V	C123	1-136-189-00	MYLAR 0.1 $\mu$ F	10% 250V
C033	1-164-004-11	CERAMIC CHIP 0.1 $\mu$ F	10% 25V	C130	1-164-489-11	CERAMIC CHIP 0.22 $\mu$ F	10% 16V
[U/C]				C152	1-104-664-11	ELECT 47 $\mu$ F	20% 25V
C035	1-104-574-11	CERAMIC 0.0047 $\mu$ F	10% 2KV	C201	1-163-233-11	CERAMIC CHIP 18pF	5% 50V
C036	1-163-251-11	CERAMIC CHIP 100pF	5% 50V	C205	1-164-004-11	CERAMIC CHIP 0.1 $\mu$ F	10% 25V
C037	1-164-004-11	CERAMIC CHIP 0.1 $\mu$ F	10% 25V	C206	1-117-450-11	MYLAR 0.47 $\mu$ F	10% 250V
C038	1-163-017-00	CERAMIC CHIP 0.0047 $\mu$ F	10% 50V	C208	1-164-489-11	CERAMIC CHIP 0.22 $\mu$ F	10% 16V
C039	1-115-339-11	CERAMIC CHIP 0.1 $\mu$ F	10% 50V	C211	1-163-251-11	CERAMIC CHIP 100pF	5% 50V
C040	1-163-021-91	CERAMIC CHIP 0.01 $\mu$ F	10% 50V	C220	1-104-664-11	ELECT 47 $\mu$ F	20% 25V
C042	1-115-339-11	CERAMIC CHIP 0.1 $\mu$ F	10% 50V	C223	1-136-189-00	MYLAR 0.1 $\mu$ F	10% 250V
C043	1-164-004-11	CERAMIC CHIP 0.1 $\mu$ F	10% 25V	C230	1-164-489-11	CERAMIC CHIP 0.22 $\mu$ F	10% 16V
C045	1-164-004-11	CERAMIC CHIP 0.1 $\mu$ F	10% 25V	C231	1-163-085-00	CERAMIC CHIP 2pF	0.25pF 50V [NH, SH, EQ]
C046	1-163-021-91	CERAMIC CHIP 0.01 $\mu$ F	10% 50V	C252	1-104-664-11	ELECT 47 $\mu$ F	20% 25V
				C301	1-163-231-11	CERAMIC CHIP 15pF	5% 50V
				C305	1-164-004-11	CERAMIC CHIP 0.1 $\mu$ F	10% 25V



Les composants identifiés par la marque  $\Delta$  sont critiques pour la sécurité.  
Ne les remplacer que par une pièce portant le numéro spécifié.

The components identified  $\Delta$  marked are critical for safety.  
Replace only with the part number specified.

REF.NO.	PART NO.	DESCRIPTION	REMARK	REF.NO.	PART NO.	DESCRIPTION	REMARK
C306	1-117-450-11	MYLAR 0.47 $\mu$ F	10% 250V	FB004	1-412-911-11	FERRITE 1.1 $\mu$ H	
C308	1-164-489-11	CERAMIC CHIP 0.22 $\mu$ F	10% 16V	FB005	1-412-911-11	FERRITE 1.1 $\mu$ H	
C311	1-163-251-11	CERAMIC CHIP 100pF	5% 50V	FB006	1-216-295-11	SHORT 0	
C319	1-163-021-91	CERAMIC CHIP 0.01 $\mu$ F	10% 50V				
C320	1-104-664-11	ELECT 47 $\mu$ F	20% 25V	FB007	1-216-295-11	SHORT 0	
				FB008	1-216-295-11	SHORT 0	
C323	1-136-189-00	MYLAR 0.1 $\mu$ F	10% 250V	FB009	1-414-231-22	INDUCTOR	
C330	1-164-489-11	CERAMIC CHIP 0.22 $\mu$ F	10% 16V	FB101	1-216-295-11	SHORT 0	
C352	1-104-664-11	ELECT 47 $\mu$ F	20% 25V	FB102	1-469-965-21	INDUCTOR	
		<CONNECTOR>		FB103	1-469-965-21	INDUCTOR	
				FB104	1-412-911-11	FERRITE 1.1 $\mu$ H	
CN303	1-695-915-11	TAB (CONTACT)		FB110	1-412-911-11	FERRITE 1.1 $\mu$ H	
CN315*	1-778-682-11	PIN, CONNECTOR (PC BOARD) 8P		FB201	1-216-295-11	SHORT 0	
CN318	1-764-101-11	PIN, CONNECTOR (PC BOARD) 2P		FB202	1-469-965-21	INDUCTOR	
		<DIODE>		FB203	1-469-965-21	INDUCTOR	
D001	8-719-801-78	DIODE 1SS184 [U/C]		FB210	1-412-911-11	FERRITE 1.1 $\mu$ H	
D002	8-719-109-89	ZENER DIODE RD5.6ESB2		FB301	1-216-295-11	SHORT 0	
D003	8-719-109-89	ZENER DIODE RD5.6ESB2 [U/C]		FB302	1-469-965-21	INDUCTOR	
D004	8-719-062-51	DIODE 1PS226-115		FB303	1-469-965-21	INDUCTOR	
D005	8-719-062-51	DIODE 1PS226-115 [U/C]					
D006	8-719-801-78	DIODE 1SS184					
D007	8-719-109-89	ZENER DIODE RD5.6ESB2 [U/C]		FB310	1-412-911-11	FERRITE 1.1 $\mu$ H	
D008	8-719-109-89	ZENER DIODE RD5.6ESB2 [U/C]					
D009	8-719-109-89	ZENER DIODE RD5.6ESB2					
D010	8-719-109-89	ZENER DIODE RD5.6ESB2					
D011	8-719-109-89	ZENER DIODE RD5.6ESB2					
D012	8-719-062-51	DIODE 1PS226-115					
D013	8-719-911-19	DIODE 1SS119-25					
D014	8-719-911-19	DIODE 1SS119-25					
D016	8-719-109-89	ZENER DIODE RD5.6ESB2					
D019	8-719-062-51	DIODE 1PS226-115					
D101	8-719-062-51	DIODE 1PS226-115					
D104	8-719-052-12	DIODE 1SS376TE-17					
D105	8-719-052-12	DIODE 1SS376TE-17					
D106	8-719-970-83	DIODE HSS82-TJ					
D108	8-719-066-10	DIODE 1PS181-115					
D111	8-719-062-51	DIODE 1PS226-115					
D201	8-719-062-51	DIODE 1PS226-115					
D204	8-719-052-12	DIODE 1SS376TE-17					
D205	8-719-052-12	DIODE 1SS376TE-17					
D206	8-719-970-83	DIODE HSS82-TJ					
D208	8-719-066-10	DIODE 1PS181-115					
D211	8-719-062-51	DIODE 1PS226-115					
D301	8-719-062-51	DIODE 1PS226-115					
D304	8-719-052-12	DIODE 1SS376TE-17					
D305	8-719-052-12	DIODE 1SS376TE-17					
D306	8-719-970-83	DIODE HSS82-TJ					
D308	8-719-066-10	DIODE 1PS181-115					
D311	8-719-062-51	DIODE 1PS226-115					
		<FERRITE BEAD>					
FB002	1-216-295-11	SHORT 0		JR001	1-216-296-91	SHORT 0	
FB003	1-412-911-11	FERRITE 1.1 $\mu$ H		JR002	1-216-296-91	SHORT 0	
				JR005	1-216-296-91	SHORT 0	
				JR007	1-216-295-11	SHORT 0	
				JR008	1-216-296-91	SHORT 0	
				JR009	1-216-296-91	SHORT 0	
				JR010	1-216-295-11	SHORT 0	
				JR011	1-216-296-91	SHORT 0 [U/C]	
				JR012	1-216-296-91	SHORT 0 [U/C]	
				JR013	1-216-296-91	SHORT 0 [U/C]	
				JR014	1-216-296-91	SHORT 0 [U/C]	
				JR015	1-216-295-11	SHORT 0	
				JR016	1-216-296-91	SHORT 0	
				JR017	1-216-296-91	SHORT 0	
				JR019	1-216-296-91	SHORT 0	
				JR020	1-216-296-91	SHORT 0	
				JR021	1-216-296-91	SHORT 0	



REF.NO.	PART NO.	DESCRIPTION	REMARK	REF.NO.	PART NO.	DESCRIPTION	REMARK
JR022	1-216-295-11	SHORT	0	R030	1-216-295-11	SHORT	0 [ U/C]
JR023	1-216-295-11	SHORT	0	R031	1-216-077-91	RES-CHIP	15K 5% 1/10W
JR024	1-216-296-91	SHORT	0	R032	1-260-316-51	CARBON	100 5% 1/2W
JR025	1-216-296-91	SHORT	0	R033	1-216-651-11	METAL CHIP	1K 0.5% 1/10W
JR026	1-216-295-11	SHORT	0	R034	1-216-055-00	RES-CHIP	1.8K 5% 1/10W
JR027	1-216-296-91	SHORT	0	R038	1-216-017-91	RES-CHIP	47 5% 1/10W
JR028	1-216-296-91	SHORT	0	R039	1-216-017-91	RES-CHIP	47 5% 1/10W
JR029	1-216-295-11	SHORT	0	R051	1-216-121-11	RES-CHIP	1M 5% 1/10W
JR030	1-216-296-91	SHORT	0	R052	1-259-884-11	CARBON	4.7M 5% 1/4W
				R053	1-216-627-11	METAL CHIP	100 0.5% 1/10W
				R054	1-260-103-11	CARBON	2.2K 5% 1/2W
	<COIL>			R055	1-216-295-11	SHORT	0
L001	1-412-537-31	INDUCTOR	100μH	R058	1-216-049-11	RES-CHIP	1K 5% 1/10W
L002	1-412-549-11	INDUCTOR	1mH	R059	1-216-057-00	RES-CHIP	2.2K 5% 1/10W
L003	1-412-537-31	INDUCTOR	100μH	R060	1-216-295-11	SHORT	0
L004	1-412-529-11	INDUCTOR	22μH	R064	1-260-127-11	CARBON	220K 5% 1/2W
L005	1-412-537-31	INDUCTOR	100μH	R077	1-216-077-91	RES-CHIP	15K 5% 1/10W
L006	1-412-537-31	INDUCTOR	100μH	R078	1-216-668-11	METAL CHIP	5.1K 0.5% 1/10W
L007	1-412-537-31	INDUCTOR	100μH	R079	1-216-663-11	METAL CHIP	3.3K 0.5% 1/10W
	<TRANSISTOR>			R080	1-216-661-11	METAL CHIP	2.7K 0.5% 1/10W
Q101	8-729-120-28	TRANSISTOR 2SC1623-L5L6		R082	1-216-369-00	METAL OXIDE	1 5% 2W
Q201	8-729-120-28	TRANSISTOR 2SC1623-L5L6		R092	1-216-077-91	RES-CHIP	15K 5% 1/10W
Q301	8-729-120-28	TRANSISTOR 2SC1623-L5L6		R095	1-216-295-11	SHORT	0
				R097	1-216-295-11	SHORT	0
				R098	1-216-089-11	RES-CHIP	47K 5% 1/10W
				R101	1-215-395-00	METAL	82 1% 1/4W
	<RESISTOR>			R104	1-216-059-00	RES-CHIP	2.7K 5% 1/10W
R001	1-216-077-91	RES-CHIP	15K 5% 1/10W	R106	1-249-436-11	CARBON	39K 5% 1/4W
				R107	1-216-085-00	RES-CHIP	33K 5% 1/10W
R002	1-216-077-91	RES-CHIP	15K 5% 1/10W	R108	1-216-065-91	RES-CHIP	4.7K 5% 1/10W
				R109	1-216-121-11	RES-CHIP	1M 5% 1/10W
R003	1-216-025-11	RES-CHIP	100 5% 1/10W	R110	1-216-037-00	RES-CHIP	330 5% 1/10W
R006	1-260-316-51	CARBON	100 5% 1/2W	R111	1-249-402-11	CARBON	56 5% 1/4W
R007	1-216-025-11	RES-CHIP	100 5% 1/10W	R115	1-216-081-00	RES-CHIP	22K 5% 1/10W
R008	1-216-025-11	RES-CHIP	100 5% 1/10W	R117	1-216-013-00	RES-CHIP	33 5% 1/10W
R010	1-216-025-11	RES-CHIP	100 5% 1/10W	R118	1-216-009-91	RES-CHIP	22 5% 1/10W
R011	1-216-057-00	RES-CHIP	2.2K 5% 1/10W	R119	1-216-113-00	RES-CHIP	470K 5% 1/10W
R012	1-216-057-00	RES-CHIP	2.2K 5% 1/10W	R120	1-216-113-00	RES-CHIP	470K 5% 1/10W
R013	1-216-025-11	RES-CHIP	100 5% 1/10W	R121	1-216-113-00	RES-CHIP	470K 5% 1/10W
R014	1-260-316-51	CARBON	100 5% 1/2W	R122	1-216-121-11	RES-CHIP	1M 5% 1/10W
R015	1-216-057-00	RES-CHIP	2.2K 5% 1/10W	R123	1-249-416-11	CARBON	820 5% 1/4W
R016	1-216-057-00	RES-CHIP	2.2K 5% 1/10W	R130	1-249-399-11	CARBON	33 5% 1/4W
R017	1-216-025-11	RES-CHIP	100 5% 1/10W	R133	1-469-965-21	INDUCTOR	
R018	1-216-025-11	RES-CHIP	100 5% 1/10W	R140	1-249-399-11	CARBON	33 5% 1/4W
R019	1-216-071-00	RES-CHIP	8.2K 5% 1/10W	R151	1-219-742-11	CARBON	47 5% 1/2W
R020	1-216-025-11	RES-CHIP	100 5% 1/10W	R161	1-215-395-00	METAL	82 1% 1/4W
R021	1-216-025-11	RES-CHIP	100 5% 1/10W	R163	1-216-025-11	RES-CHIP	100 5% 1/10W
R022	1-216-295-11	SHORT	0	R164	1-216-099-00	RES-CHIP	120K 5% 1/10W
R023	1-216-049-11	RES-CHIP	1K 5% 1/10W	R201	1-215-395-00	METAL	82 1% 1/4W
R024	1-216-065-91	RES-CHIP	4.7K 5% 1/10W	R202	1-216-041-00	METAL CHIP	470 5% 1/10W
R025	1-216-065-91	RES-CHIP	4.7K 5% 1/10W				[NH, SH, EQ]
R027	1-216-017-91	RES-CHIP	47 5% 1/10W	R204	1-216-059-00	RES-CHIP	2.7K 5% 1/10W
				R206	1-249-436-11	CARBON	39K 5% 1/4W
R028	1-216-017-91	RES-CHIP	47 5% 1/10W	R207	1-216-085-00	RES-CHIP	33K 5% 1/10W
				R208	1-216-065-91	RES-CHIP	4.7K 5% 1/10W
				R209	1-216-121-11	RES-CHIP	1M 5% 1/10W





REF.NO.	PART NO.	DESCRIPTION	REMARK	REF.NO.	PART NO.	DESCRIPTION	REMARK
R210	1-216-045-00	RES-CHIP	680 5% 1/10W			DA BOARD, COMPLETE *****	
R211	1-249-403-11	CARBON	68 5% 1/4W				
R215	1-216-081-00	RES-CHIP	22K 5% 1/10W				
R217	1-216-013-00	RES-CHIP	33 5% 1/10W				
R218	1-216-017-91	RES-CHIP	47 5% 1/10W				
R219	1-216-113-00	RES-CHIP	470K 5% 1/10W			<CAPACITOR>	
R220	1-216-113-00	RES-CHIP	470K 5% 1/10W	C1101	1-164-004-11	CERAMIC CHIP 0.1µF 10% 25V	
R221	1-216-113-00	RES-CHIP	470K 5% 1/10W	C1102	1-164-004-11	CERAMIC CHIP 0.1µF 10% 25V	
R222	1-216-121-11	RES-CHIP	1M 5% 1/10W	C1103	1-164-004-11	CERAMIC CHIP 0.1µF 10% 25V	
R223	1-249-416-11	CARBON	820 5% 1/4W	C1104	1-164-004-11	CERAMIC CHIP 0.1µF 10% 25V	
R230	1-249-399-11	CARBON	33 5% 1/4W	C1105	1-163-021-91	CERAMIC CHIP 0.01µF 10% 50V	
R233	1-469-965-21	INDUCTOR		C1108	1-163-021-91	CERAMIC CHIP 0.01µF 10% 50V	
R240	1-249-399-11	CARBON	33 5% 1/4W	C1109	1-163-021-91	CERAMIC CHIP 0.01µF 10% 50V	
R251	1-219-742-11	CARBON	47 5% 1/2W	C1110	1-163-021-91	CERAMIC CHIP 0.01µF 10% 50V	
R261	1-215-395-00	METAL	82 1% 1/4W	C1111	1-163-021-91	CERAMIC CHIP 0.01µF 10% 50V	
R263	1-216-025-11	RES-CHIP	100 5% 1/10W	C1112	1-164-004-11	CERAMIC CHIP 0.1µF 10% 25V	
R264	1-216-099-00	RES-CHIP	120K 5% 1/10W	C1113	1-163-021-91	CERAMIC CHIP 0.01µF 10% 50V	
R301	1-215-395-00	METAL	82 1% 1/4W	C1114	1-163-017-00	CERAMIC CHIP 0.0047µF 10% 50V	
R304	1-216-059-00	RES-CHIP	2.7K 5% 1/10W	C1115	1-163-021-91	CERAMIC CHIP 0.01µF 10% 50V	
R306	1-249-436-11	CARBON	39K 5% 1/4W	C1116	1-163-021-91	CERAMIC CHIP 0.01µF 10% 50V	
R307	1-216-085-00	RES-CHIP	33K 5% 1/10W	C1117	1-163-019-00	CERAMIC CHIP 0.0068µF 10% 50V	
R308	1-216-065-91	RES-CHIP	4.7K 5% 1/10W	C1118	1-164-004-11	CERAMIC CHIP 0.1µF 10% 25V	
R309	1-216-121-11	RES-CHIP	1M 5% 1/10W	C1119	1-163-021-91	CERAMIC CHIP 0.01µF 10% 50V	
R310	1-216-037-00	RES-CHIP	330 5% 1/10W	C1120	1-163-251-11	CERAMIC CHIP 100pF 5% 50V	
R311	1-249-402-11	CARBON	56 5% 1/4W	C1121	1-163-019-00	CERAMIC CHIP 0.0068µF 10% 50V	
R315	1-216-081-00	RES-CHIP	22K 5% 1/10W	C1122	1-164-004-11	CERAMIC CHIP 0.1µF 10% 25V	
R317	1-216-013-00	RES-CHIP	33 5% 1/10W	C1123	1-164-004-11	CERAMIC CHIP 0.1µF 10% 25V	
R318	1-216-019-00	RES-CHIP	56 5% 1/10W	C1124	1-163-005-11	CERAMIC CHIP 47pF 10% 50V	
R319	1-216-113-00	RES-CHIP	470K 5% 1/10W	C1125	1-163-021-91	CERAMIC CHIP 0.01µF 10% 50V	
R320	1-216-113-00	RES-CHIP	470K 5% 1/10W	C1126	1-163-021-91	CERAMIC CHIP 0.01µF 10% 50V	
R321	1-216-113-00	RES-CHIP	470K 5% 1/10W	C1127	1-125-838-11	CERAMIC CHIP 2.2µF 10% 6.3V	
R322	1-216-121-11	RES-CHIP	1M 5% 1/10W	C1128	1-126-246-11	ELECT 220µF 20% 4V	
R323	1-249-416-11	CARBON	820 5% 1/4W	C1129	1-163-007-11	CERAMIC CHIP 680pF 10% 50V	
R330	1-249-399-11	CARBON	33 5% 1/4W	C1130	1-164-492-11	CERAMIC CHIP 0.15µF 10% 16V	
R333	1-469-965-21	INDUCTOR		C1131	1-164-004-11	CERAMIC CHIP 0.1µF 10% 25V	
R340	1-249-399-11	CARBON	33 5% 1/4W	C1132	1-163-021-91	CERAMIC CHIP 0.01µF 10% 50V	
R351	1-219-742-11	CARBON	47 5% 1/2W	C1133	1-126-246-11	ELECT 220µF 20% 4V	
R361	1-215-395-00	METAL	82 1% 1/4W	C1137	1-126-205-11	ELECT 47µF 20% 6.3V	
R363	1-216-025-11	RES-CHIP	100 5% 1/10W	C1138	1-163-251-11	CERAMIC CHIP 100pF 5% 50V	
R364	1-216-099-00	RES-CHIP	120K 5% 1/10W	C1139	1-164-004-11	CERAMIC CHIP 0.1µF 10% 25V	
				C1140	1-163-251-11	CERAMIC CHIP 100pF 5% 50V	
		<SPARK GAP>				<DIODE>	
SG001	1-519-422-11	SPARK GAP		D1104	8-719-027-76	DIODE 1SS357-TPH3	
SG002	1-576-354-21	SPARK GAP		D1105	8-719-067-40	ZENER DIODE STZ6.8N-T146	
SG101	1-576-354-21	SPARK GAP		D1106	8-719-067-40	ZENER DIODE STZ6.8N-T146	
SG201	1-576-354-21	SPARK GAP		D1107	8-719-067-40	ZENER DIODE STZ6.8N-T146	
SG301	1-576-354-21	SPARK GAP				<FERRITE BEAD>	
		<CRYSTAL>		FB1101	1-543-963-22	FERRITE	
X001	1-760-682-21	VIBRATOR, CRYSTAL (24.5 MHz)				<IC>	
				IC1101	8-759-697-78	IC CXD9563Q	
				IC1102	8-759-701-01	IC NJM2904M	



REF.NO.	PART NO.	DESCRIPTION	REMARK	REF.NO.	PART NO.	DESCRIPTION	REMARK
<RESISTOR>				D BOARD, COMPLETE *****			
R1101	1-216-025-11	RES-CHIP	100 5% 1/10W	3-710-578-01	COVER, VOLUME, 6 MOLD (RV901)		
R1102	1-216-057-00	RES-CHIP	2.2K 5% 1/10W	4-382-854-01	SCREW (3X8), P, SW (+) (D610, IC654, Q640, Q641, R510)		
R1103	1-216-025-11	RES-CHIP	100 5% 1/10W	4-382-854-11	SCREW (3X10), P, SW (+) (D504, D652, D680, IC401, IC703, Q505, Q506, Q511, Q512, Q513, Q514, Q630, Q704, Q705, Q901, Q902, R909)		
R1106	1-216-691-11	METAL CHIP	47K 0.5% 1/10W	* 7-322-065-48	RUBBER, SILICONE RTV (KE-3490) (RV901) [AEP, NH, SH, EQ, U/C for Japan-made set]		
R1108	1-216-067-00	RES-CHIP	5.6K 5% 1/10W	7-682-950-01	+PSW 3X12 (IC610)		
R1109	1-216-067-00	RES-CHIP	5.6K 5% 1/10W	<CAPACITOR>			
R1110	1-216-675-91	METAL CHIP	10K 0.5% 1/10W	C401	1-128-528-11	ELECT	470µF 20% 25V
R1111	1-216-673-11	METAL CHIP	8.2K 0.5% 1/10W	C402	1-130-785-11	MYLAR	0.47µF 10% 100V
R1112	1-216-073-00	RES-CHIP	10K 5% 1/10W	C403	1-107-911-11	ELECT	220µF 20% 50V
R1113	1-216-665-11	METAL CHIP	3.9K 0.5% 1/10W	C404	1-128-528-11	ELECT	470µF 20% 25V
R1114	1-216-049-11	RES-CHIP	1K 5% 1/10W	C405	1-163-009-11	CERAMIC CHIP	0.001µF 10% 50V
R1115	1-216-691-11	METAL CHIP	47K 0.5% 1/10W	C406	1-137-366-11	MYLAR	0.0022µF 5% 50V
R1116	1-216-655-11	METAL CHIP	1.5K 0.5% 1/10W	C407	1-164-161-11	CERAMIC CHIP	0.0022µF 10% 50V
R1118	1-216-057-00	RES-CHIP	2.2K 5% 1/10W	C408	1-163-222-11	CERAMIC CHIP	5pF 0.25pF 50V
R1119	1-216-049-11	RES-CHIP	1K 5% 1/10W	C500	1-163-259-91	CERAMIC CHIP	220pF 5% 50V
R1122	1-216-659-11	METAL CHIP	2.2K 0.5% 1/10W	C502	1-137-150-11	MYLAR	0.01µF 5% 50V
R1123	1-216-656-11	METAL CHIP	1.6K 0.5% 1/10W	C503	1-130-495-00	MYLAR	0.1µF 5% 50V
R1124	1-216-643-11	METAL CHIP	470 0.5% 1/10W	C504	1-137-368-11	MYLAR	0.0047µF 5% 50V
R1125	1-216-659-11	METAL CHIP	2.2K 0.5% 1/10W	C505	1-126-949-11	ELECT	220µF 20% 35V
R1126	1-216-642-11	METAL CHIP	430 0.5% 1/10W	C506	1-127-810-51	ELECT	22µF 20% 250V
R1127	1-216-073-00	RES-CHIP	10K 5% 1/10W	C507	1-136-207-11	MYLAR	0.047µF 5% 400V
R1128	1-216-105-91	RES-CHIP	220K 5% 1/10W	C508	1-137-715-11	FILM	3300pF 3% 1.8KV
R1129	1-216-683-11	METAL CHIP	22K 0.5% 1/10W	C509	1-107-444-11	CERAMIC	100pF 5% 2KV
R1131	1-216-025-11	RES-CHIP	100 5% 1/10W	C510	1-136-684-51	MYLAR	0.0022µF 10% 100V
R1132	1-216-025-11	RES-CHIP	100 5% 1/10W	C511	1-163-038-11	CERAMIC CHIP	0.1µF 25V
R1133	1-216-121-11	RES-CHIP	1M 5% 1/10W	C512	1-163-005-11	CERAMIC CHIP	470pF 10% 50V
R1134	1-216-663-11	METAL CHIP	3.3K 0.5% 1/10W	C513	1-163-038-11	CERAMIC CHIP	0.1µF 25V
R1135	1-216-121-11	RES-CHIP	1M 5% 1/10W	C514	1-137-368-11	MYLAR	0.0047µF 5% 50V
R1136	1-216-049-11	RES-CHIP	1K 5% 1/10W	C515	1-163-021-91	CERAMIC CHIP	0.01µF 10% 50V
R1137	1-218-758-11	METAL CHIP	180K 0.5% 1/10W	C516	1-126-934-11	ELECT	220µF 20% 16V
R1139	1-216-691-11	METAL CHIP	47K 0.5% 1/10W	C517	1-163-133-00	CERAMIC CHIP	470pF 5% 50V
R1141	1-216-025-11	RES-CHIP	100 5% 1/10W	C519	1-163-017-00	CERAMIC CHIP	0.0047µF 10% 50V
R1142	1-216-295-11	SHORT	0	C520	1-163-023-00	CERAMIC CHIP	0.015µF 10% 50V
<COMPOSITION CIRCUIT BLOCK>				C521	1-163-021-91	CERAMIC CHIP	0.01µF 10% 50V
RB1101	1-233-576-11	NETWORK, RESISTOR (CHIP)	100	C522	1-126-965-11	ELECT	22µF 20% 50V
RB1102	1-233-412-11	NETWORK, RESISTOR (CHIP)	1.0K (3216)	C524	1-126-941-11	ELECT	470µF 20% 25V
RB1103	1-233-412-11	NETWORK, RESISTOR (CHIP)	1.0K (3216)	C525	1-164-004-11	CERAMIC CHIP	0.1µF 10% 25V
RB1104	1-233-576-11	NETWORK, RESISTOR (CHIP)	100	C533	1-163-017-00	CERAMIC CHIP	0.0047µF 10% 50V
RB1105	1-233-576-11	NETWORK, RESISTOR (CHIP)	100	C534	1-163-021-91	CERAMIC CHIP	0.01µF 10% 50V
RB1106	1-233-412-11	NETWORK, RESISTOR (CHIP)	1.0K (3216)	C535	1-164-004-11	CERAMIC CHIP	0.1µF 10% 25V
*****				C536	1-107-665-11	ELECT	0.47µF 20% 400V
				C537	1-137-868-11	FILM	0.13µF 5% 400V
				C538	1-107-651-11	ELECT	4.7µF 20% 250V
				C539	1-115-356-11	FILM	1.2µF 5% 250V
				C540	1-107-888-11	ELECT	47µF 20% 25V
				C541	1-115-521-11	FILM	0.82µF 5% 250V
				C542	1-164-346-11	CERAMIC CHIP	1µF 16V
				C543	1-117-666-11	FILM	0.39µF 5% 250V



Les composants identifiés par la marque  $\Delta$  sont critiques pour la sécurité.  
Ne les remplacer que par une pièce portant le numéro spécifié.

The components identified  $\Delta$  marked are critical for safety.  
Replace only with the part number specified.

REF.NO.	PART NO.	DESCRIPTION	REMARK	REF.NO.	PART NO.	DESCRIPTION	REMARK
C544	1-164-005-11	CERAMIC CHIP 0.47 $\mu$ F	16V	C681	1-107-889-11	ELECT 220 $\mu$ F 20%	10V
C545	1-117-662-11	FILM 0.18 $\mu$ F 5%	250V	C682	1-137-368-11	MYLAR 0.0047 $\mu$ F 5%	50V
C546	1-164-222-11	CERAMIC CHIP 0.22 $\mu$ F	25V	C683	1-115-706-11	ELECT 220 $\mu$ F 20%	6.3V
C547	1-119-860-11	FILM 0.082 $\mu$ F 5%	250V	C686	1-115-706-11	ELECT 220 $\mu$ F 20%	6.3V
C548	1-163-021-91	CERAMIC CHIP 0.01 $\mu$ F 10%	50V	C687	1-130-495-00	MYLAR 0.1 $\mu$ F 5%	50V
C549	1-136-060-00	FILM 0.047 $\mu$ F 5%	400V	C692	1-115-706-11	ELECT 220 $\mu$ F 20%	6.3V
C550	1-163-021-91	CERAMIC CHIP 0.01 $\mu$ F 10%	50V	C693	1-113-903-11	CERAMIC 0.001 $\mu$ F 20%	250V
C554	1-163-009-11	CERAMIC CHIP 0.001 $\mu$ F 10%	50V	C701	1-163-003-11	CERAMIC CHIP 330pF 10%	50V
C559	1-163-038-11	CERAMIC CHIP 0.1 $\mu$ F	25V	C703	1-163-003-11	CERAMIC CHIP 330pF 10%	50V
C560	1-137-856-11	FILM 0.018 $\mu$ F 5%	400V	C704	1-137-150-11	MYLAR 0.01 $\mu$ F 5%	50V
C561	1-163-021-91	CERAMIC CHIP 0.01 $\mu$ F 10%	50V	C705	1-164-004-11	CERAMIC CHIP 0.1 $\mu$ F 10%	25V
C562	1-163-009-11	CERAMIC CHIP 0.001 $\mu$ F 10%	50V	C706	1-137-150-11	MYLAR 0.01 $\mu$ F 5%	50V
C563	1-104-572-11	CERAMIC 0.0022 $\mu$ F 10%	2KV	C707	1-104-666-11	ELECT 220 $\mu$ F 20%	25V
C564	1-163-021-91	CERAMIC CHIP 0.01 $\mu$ F 10%	50V	C708	1-104-666-11	ELECT 220 $\mu$ F 20%	25V
C565	1-164-004-11	CERAMIC CHIP 0.1 $\mu$ F 10%	25V	C711	1-163-239-11	CERAMIC CHIP 33pF 5%	50V
C566	1-164-004-11	CERAMIC CHIP 0.1 $\mu$ F 10%	25V	C712	1-163-239-11	CERAMIC CHIP 33pF 5%	50V
C601 $\Delta$	1-107-533-51	MYLAR 1 $\mu$ F 20%	250V	C713	1-163-021-91	CERAMIC CHIP 0.01 $\mu$ F 10%	50V
C602 $\Delta$	1-104-708-51	MYLAR 0.47 $\mu$ F 20%	250V	C714	1-163-021-91	CERAMIC CHIP 0.01 $\mu$ F 10%	50V
C603 $\Delta$	1-113-900-51	CERAMIC 470pF 10%	250V	C718	1-163-038-11	CERAMIC CHIP 0.1 $\mu$ F	25V
C604 $\Delta$	1-113-900-51	CERAMIC 470pF 10%	250V	C719	1-163-038-11	CERAMIC CHIP 0.1 $\mu$ F	25V
C605 $\Delta$	1-113-926-91	CERAMIC 0.0047 $\mu$ F 250V		C720	1-163-021-91	CERAMIC CHIP 0.01 $\mu$ F 10%	50V
C606 $\Delta$	1-113-926-91	CERAMIC 0.0047 $\mu$ F 250V		C721	1-128-562-11	ELECT 47 $\mu$ F 20%	100V
C607	1-119-913-51	CERAMIC 2200pF 20%	250V	C722	1-128-560-11	ELECT 22 $\mu$ F 20%	100V
C610	1-137-673-11	ELECT 330 $\mu$ F 20%	450V	C724	1-162-134-11	CERAMIC 470pF 10%	2KV
C611	1-117-227-11	MYLAR 1 $\mu$ F 10%	450V	C726	1-163-038-11	CERAMIC CHIP 0.1 $\mu$ F	25V
C612	1-136-169-00	FILM 0.22 $\mu$ F 5%	50V	C727	1-163-038-11	CERAMIC CHIP 0.1 $\mu$ F	25V
C613	1-126-967-11	ELECT 47 $\mu$ F 20%	50V	C730	1-163-009-11	CERAMIC CHIP 0.001 $\mu$ F 10%	50V
C614	1-163-251-11	CERAMIC CHIP 100pF 5%	50V	C732	1-163-021-91	CERAMIC CHIP 0.01 $\mu$ F 10%	50V
C629	1-163-017-00	CERAMIC CHIP 0.0047 $\mu$ F 10%	50V	C733	1-117-722-11	ELECT 2200 $\mu$ F 20%	10V
C630	1-163-038-11	CERAMIC CHIP 0.1 $\mu$ F	25V	C734	1-164-004-11	CERAMIC CHIP 0.1 $\mu$ F 10%	25V
C631	1-104-665-11	ELECT 100 $\mu$ F 20%	25V	C736	1-126-967-11	ELECT 47 $\mu$ F 20%	50V
C632	1-126-961-11	ELECT 2.2 $\mu$ F 20%	50V	C737	1-126-967-11	ELECT 47 $\mu$ F 20%	50V
C635	1-163-005-11	CERAMIC CHIP 470pF 10%	50V	C738	1-136-169-00	FILM 0.22 $\mu$ F 5%	50V
C636	1-164-161-11	CERAMIC CHIP 0.0022 $\mu$ F 10%	50V	C761	1-163-021-91	CERAMIC CHIP 0.01 $\mu$ F 10%	50V
C640	1-126-964-11	ELECT 10 $\mu$ F 20%	50V	C900	1-107-713-11	ELECT 4.7 $\mu$ F 20%	50V
C641	1-107-792-11	CERAMIC 100pF 5%	1KV	C901	1-104-665-11	ELECT 100 $\mu$ F 20%	25V
C642	1-136-189-00	MYLAR 0.1 $\mu$ F 10%	250V	C902	1-163-021-91	CERAMIC CHIP 0.01 $\mu$ F 10%	50V
C643	1-107-792-11	CERAMIC 100pF 5%	1KV	C903	1-126-962-11	ELECT 3.3 $\mu$ F 20%	50V
C644	1-136-165-00	FILM 0.1 $\mu$ F 5%	50V	C904	1-115-339-11	CERAMIC CHIP 0.1 $\mu$ F 10%	50V
C645	1-136-479-11	FILM 0.001 $\mu$ F 2%	50V	C905	1-163-133-00	CERAMIC CHIP 470pF 5%	50V
C646	1-126-961-11	ELECT 2.2 $\mu$ F 20%	50V	C906	1-163-251-11	CERAMIC CHIP 100pF 5%	50V
C647	1-126-963-11	ELECT 4.7 $\mu$ F 20%	50V	C908	1-163-021-91	CERAMIC CHIP 0.01 $\mu$ F 10%	50V
C648	1-126-967-11	ELECT 47 $\mu$ F 20%	50V	C909	1-104-665-11	ELECT 100 $\mu$ F 20%	25V
C649	1-163-009-11	CERAMIC CHIP 0.001 $\mu$ F 10%	50V	C910	1-163-259-91	CERAMIC CHIP 220pF 5%	50V
C650	1-107-656-11	ELECT 100 $\mu$ F 20%	250V	C911	1-163-137-00	CERAMIC CHIP 680pF 5%	50V
C652	1-128-563-11	ELECT 100 $\mu$ F 20%	100V	C913	1-135-842-51	ELECT 47 $\mu$ F 20%	250V
C654	1-126-943-11	ELECT 2200 $\mu$ F 20%	25V	C914	1-136-203-91	METALIZED FILM 0.01 $\mu$ F	
C655	1-104-664-11	ELECT 47 $\mu$ F 20%	25V	C915	1-137-867-11	PP FILM	
C656	1-126-943-11	ELECT 2200 $\mu$ F 20%	25V	C916	1-117-665-11	FILM 0.33 $\mu$ F 5%	250V
C657	1-104-664-11	ELECT 47 $\mu$ F 20%	25V	C917	1-115-339-11	CERAMIC CHIP 0.1 $\mu$ F 10%	50V
C658	1-137-725-21	FILM 8200pF 3%	800V	C918	1-117-626-11	FILM 2000pF 3%	1.2KV
C667	1-107-909-11	ELECT 47 $\mu$ F 20%	16V	C919	1-115-349-51	CERAMIC 0.01 $\mu$ F	2KV
C680	1-107-886-11	ELECT 4700 $\mu$ F 20%	16V	C920	1-115-349-51	CERAMIC 0.01 $\mu$ F	2KV
C680	1-115-747-51	ELECT 0.0068F 20%	10V	C921	1-163-038-11	CERAMIC CHIP 0.1 $\mu$ F	25V
			[U/C]	C923	1-126-959-11	ELECT 0.47 $\mu$ F 20%	50V
			[NH, SH, EQ]	C925	1-137-372-11	MYLAR 0.022 $\mu$ F 5%	50V



The components identified  $\Delta$  marked are critical for safety.  
Replace only with the part number specified.

Les composants identifiés par la marque  $\Delta$  sont critiques pour la sécurité.  
Ne les remplacer que par une pièce portant le numéro spécifié.

REF.NO.	PART NO.	DESCRIPTION	REMARK	REF.NO.	PART NO.	DESCRIPTION	REMARK
C926	1-106-220-00	MYLAR	0.1 $\mu$ F 10% 100V				
C927	1-102-228-00	CERAMIC	470pF 10% 500V				
C929	1-126-963-11	ELECT	4.7 $\mu$ F 20% 50V				
C930	1-136-169-00	FILM	0.22 $\mu$ F 5% 50V				
C932	1-164-004-11	CERAMIC CHIP	0.1 $\mu$ F 10% 25V				
C933	1-104-664-11	ELECT	47 $\mu$ F 20% 25V				
C935	1-163-021-91	CERAMIC CHIP	0.01 $\mu$ F 10% 50V				
C936	1-163-009-11	CERAMIC CHIP	0.001 $\mu$ F 10% 50V				
C937	1-128-551-11	ELECT	22 $\mu$ F 20% 25V				
C938	1-126-935-11	ELECT	470 $\mu$ F 20% 16V				
<CONNECTOR>							
CN501*	1-793-239-11	PIN, CONNECTOR (PC BOARD)	6P				
CN601*	1-580-689-11	PIN, CONNECTOR (PC BOARD)	4P				
CN602*	1-691-960-11	PIN, CONNECTOR (PC BOARD)	3P				
CN604	1-770-724-11	9P					
CN605*	1-564-507-11	PLUG, CONNECTOR	4P [NH, SH, EQ]				
CN701*	1-764-333-11	PLUG, CONNECTOR	10P				
CN904	1-695-915-11	TAB (CONTACT)					
CN1101*	1-508-879-11	BASE POST					
CN1102	1-774-628-11	17P					
CN1103*	1-564-511-11	PLUG, CONNECTOR	8P				
<DIODE>							
D401	8-719-979-58	DIODE EGP10D					
D405	8-719-109-85	ZENER DIODE RD5.1ESB2					
D406	8-719-050-84	DIODE RB441Q-40T-77					
D501	8-719-110-47	ZENER DIODE RD18ESB					
D502	8-719-054-71	DIODE D5SC4M-F					
D503	8-719-110-47	ZENER DIODE RD18ESB					
D504	8-719-066-36	DIODE FMQ-G5GS					
D505	8-719-052-86	DIODE D2L40-TA					
D506	8-719-062-89	ZENER DIODE HZS5B2-TE					
D509	8-719-073-01	DIODE MA111-(K8).S0					
D510	8-719-082-50	DIODE 11DF2N-TA2B2					
D512	8-719-911-19	DIODE 1SS119-25					
D516	8-719-052-90	DIODE D1NL40-TA					
D517	8-719-082-50	DIODE 11DF2N-TA2B2					
D518	8-719-050-84	DIODE RB441Q-40T-77					
D519	8-719-069-54	ZENER DIODE UDZS-TE17-5.1B					
D520	8-719-911-19	DIODE 1SS119-25					
D521	8-719-911-19	DIODE 1SS119-25					
D610	$\Delta$ 8-719-510-53	DIODE D4SB60L					
D613	8-719-304-63	DIODE RM11C					
D631	8-719-063-73	DIODE D1NL20U-TR					
D632	8-719-059-23	DIODE P6KE200AG23					
D633	8-719-069-63	DIODE ERB38-06V1					
D634	8-719-063-73	DIODE D1NL20U-TR					
D635	8-719-110-67	ZENER DIODE RD27ES-B2					
D641	8-719-069-63	DIODE ERB38-06V1					
D643	8-719-073-01	DIODE MA111-(K8).S0					
D644	8-719-073-01	DIODE MA111-(K8).S0					
D650	8-719-064-49	DIODE D4SBL40					
D651	8-719-063-74	DIODE D1NL20U-TR2					
D652	8-719-052-91	DIODE D4SBS4-F					
D680	8-719-510-41	DIODE D10SC9M					
D690	8-719-911-19	DIODE 1SS119-25					
D692	8-719-911-19	DIODE 1SS119-25					
D694	8-719-911-19	DIODE 1SS119-25					
D697	8-719-073-01	DIODE MA111-(K8).S0					
D701	8-719-911-19	DIODE 1SS119-25					
D702	8-719-911-19	DIODE 1SS119-25					
D703	8-719-911-19	DIODE 1SS119-25					
D705	8-719-073-01	DIODE MA111-(K8).S0					
D706	8-719-069-54	ZENER DIODE UDZS-TE17-5.1B					
D901	8-719-073-01	DIODE MA111-(K8).S0					
D906	8-719-977-40	ZENER DIODE DTZ13B					
D907	8-719-052-86	DIODE D2L40-TA					
D909	8-719-110-47	ZENER DIODE RD18ESB					
D910	8-719-028-72	DIODE RGP02-17EL-6433					
D911	8-719-018-82	DIODE RGP02-20EL-6394					
D912	8-719-110-42	ZENER DIODE RD15ES-B3					
D914	8-719-970-83	DIODE HSS82-TJ					
D917	8-719-069-60	ZENER DIODE UDZS-TE17-9.1B					
D918	8-719-073-01	DIODE MA111-(K8).S0					
D919	8-719-069-54	ZENER DIODE UDZS-TE17-5.1B					
D920	8-719-977-28	ZENER DIODE DTZ10B					
D921	8-719-911-19	DIODE 1SS119-25					
D922	8-719-073-01	DIODE MA111-(K8).S0					
D923	8-719-073-01	DIODE MA111-(K8).S0					
<FUSE>							
F601	$\Delta$ 1-576-233-11	FUSE (H.B.C) (6.3A/250V)					
<FERRITE BEAD>							
FB501	1-410-397-21	FERRITE	1.1 $\mu$ H				
FB555	1-216-295-11	SHORT	0				
FB901	1-412-911-11	FERRITE	1.1 $\mu$ H				
FB902	1-414-231-22	INDUCTOR					
FB1000	1-414-231-22	INDUCTOR					
FB1002	1-216-295-11	SHORT	0				
FB1005	1-216-295-11	SHORT	0				
FB1007	1-216-295-11	SHORT	0				
<FUSE HOLDER>							
FH601	1-533-223-11	HOLDER, FUSE (F601)					
FH602	1-533-223-11	HOLDER, FUSE (F601)					
<IC>							
IC401	8-759-192-71	IC STV9379					
IC501	8-759-585-82	IC BA9759F-E2					
IC610	8-749-018-08	IC MZ1532					
IC620	8-759-670-30	IC MCZ3001D					
IC630	8-759-535-32	IC FA13842P					
IC640	8-749-018-07	IC SEB3-LF4					

CPD-G520



REF.NO.	PART NO.	DESCRIPTION	REMARK	REF.NO.	PART NO.	DESCRIPTION	REMARK		
IC652	8-759-669-10	IC BA3953T-V5		<TRANSISTOR>					
IC654	8-759-701-79	IC NJM7812FA		Q501	8-729-120-28	TRANSISTOR 2SC1623-L5L6			
IC680	8-759-682-42	IC MM1431ATT		Q502	8-729-049-86	TRANSISTOR 2PD602AR-115			
IC701	8-759-822-38	IC LA6510		Q503	8-729-049-85	TRANSISTOR 2PB710AR-115			
IC702	8-749-017-48	IC STK391-220		Q504	8-729-043-53	TRANSISTOR IRFU110			
IC703	8-759-803-42	IC LA6500-FA		Q505	8-729-053-30	TRANSISTOR 2SC5570 (LBSONY1)			
IC901	8-759-585-81	IC BA9758FS-E2		Q506	8-729-053-13	TRANSISTOR 2SJ585LS-CC11			
IC902	8-759-701-01	IC NJM2904M		Q507	8-729-120-28	TRANSISTOR 2SC1623-L5L6			
<CHIP CONDUCTOR>				Q508	8-729-049-86	TRANSISTOR 2PD602AR-115			
JR001	1-216-295-11	SHORT	0	Q509	8-729-049-85	TRANSISTOR 2PB710AR-115			
JR002	1-216-296-91	SHORT	0	Q510	8-729-423-33	TRANSISTOR 2SC3311A-QRSTA			
JR003	1-216-296-91	SHORT	0	Q511	8-729-043-41	TRANSISTOR 2SK2098-01MR-F119			
JR004	1-216-296-91	SHORT	0	Q512	8-729-043-41	TRANSISTOR 2SK2098-01MR-F119			
JR006	1-216-296-91	SHORT	0	Q513	8-729-046-62	TRANSISTOR FS30KMJ-3-AZ			
JR007	1-216-295-11	SHORT	0	Q514	8-729-053-82	TRANSISTOR FS10KMJ-3-AZ			
JR008	1-216-296-91	SHORT	0	Q515	8-729-047-72	TRANSISTOR 2SK3155-01			
JR009	1-216-295-11	SHORT	0	Q516	8-729-047-72	TRANSISTOR 2SK3155-01			
JR012	1-216-296-91	SHORT	0	Q517	8-729-047-72	TRANSISTOR 2SK3155-01			
JR013	1-216-295-11	SHORT	0	Q519	8-729-026-49	TRANSISTOR 2SA1037AK-T146-R			
JR014	1-216-296-91	SHORT	0	Q521	8-729-901-00	TRANSISTOR DTC124EK			
JR015	1-216-295-11	SHORT	0	Q523	8-729-027-31	TRANSISTOR DTA124EKA-T146			
JR016	1-216-296-91	SHORT	0	Q524	8-729-901-00	TRANSISTOR DTC124EK			
JR017	1-216-295-11	SHORT	0	Q610	8-729-029-55	TRANSISTOR DTA143ZSA-TP			
JR018	1-216-295-11	SHORT	0	Q611	8-729-029-96	TRANSISTOR DTC143XSA			
JR019	1-216-296-91	SHORT	0	Q630	8-729-045-03	TRANSISTOR 2SK2647-01MR-F91			
JR022	1-216-296-91	SHORT	0	Q640	8-729-052-29	TRANSISTOR 2SK2876-01MR-F122			
<COIL>				Q641	8-729-052-29	TRANSISTOR 2SK2876-01MR-F122			
L501	1-412-537-31	INDUCTOR	100μH	Q652	8-729-029-66	TRANSISTOR DTC114ESA			
L502	1-419-871-11	COIL, HORIZONTAL LINEARITY		Q701	8-729-800-32	TRANSISTOR 2SC2362K-G			
L504	1-406-673-11	INDUCTOR	2.2mH	Q702	8-729-178-43	TRANSISTOR 2SC2784			
L505	1-406-675-11	INDUCTOR	4.7mH	Q703	8-729-204-91	TRANSISTOR 2SA1049-GR			
L506	1-406-673-11	INDUCTOR	2.2mH	Q704	8-729-207-82	TRANSISTOR 2SC3421-Y			
L508	1-412-525-31	INDUCTOR	10μH	Q705	8-729-207-89	TRANSISTOR 2SA1358-Y			
L509	1-419-869-11	COIL, HORIZONTAL CENTER		Q706	8-729-045-47	TRANSISTOR 2SC4620TV2Q			
L510	1-411-594-41	INDUCTOR	5mH	Q707	8-729-026-49	TRANSISTOR 2SA1037AK-T146-R			
L610	1-419-837-11	INDUCTOR	340μH	Q901	8-729-035-54	TRANSISTOR 2SJ449			
L611	1-419-397-11	INDUCTOR	68μH	Q902	8-729-053-42	TRANSISTOR FS5KM-18A-AT			
L612	1-412-521-31	INDUCTOR	4.7μH	Q903	8-729-049-86	TRANSISTOR 2PD602AR-115			
L652	1-406-665-11	INDUCTOR	100μH	Q904	8-729-049-85	TRANSISTOR 2PB710AR-115			
L653	1-406-665-11	INDUCTOR	100μH	Q905	8-729-046-80	TRANSISTOR 2SC4634LS-CB11			
L680	1-414-742-21	INDUCTOR	22μH	Q906	8-729-026-49	TRANSISTOR 2SA1037AK-T146-R			
L902	1-406-661-21	INDUCTOR	22μH	Q907	8-729-216-22	TRANSISTOR 2SA1162-G			
L1001	1-412-911-11	FERRITE	1.1μH	<RESISTOR>					
<PHOTO COUPLER>				R401	1-249-383-11	CARBON	1.5	5%	1/4W
PH610	8-749-018-06	IC TLP421F(D4-SONY)		R402	1-215-867-00	METAL OXIDE	470	5%	1W
PH620	8-749-018-06	IC TLP421F(D4-SONY)		R403	1-214-796-00	METAL	1.5	1%	1/2W
PH630	8-749-018-06	IC TLP421F(D4-SONY)		R404	1-215-449-00	METAL	15K	1%	1/4W
				R405	1-214-796-00	METAL	1.5	1%	1/2W
				R406	1-215-451-00	METAL	18K	1%	1/4W
				R407	1-216-675-91	METAL CHIP	10K	0.5%	1/10W
				R408	1-216-097-11	RES-CHIP	100K	5%	1/10W
				R409	1-216-679-11	METAL CHIP	15K	0.5%	1/10W
				R410	1-216-681-11	METAL CHIP	18K	0.5%	1/10W



REF.NO.	PART NO.	DESCRIPTION	REMARK	REF.NO.	PART NO.	DESCRIPTION	REMARK
R501	1-216-049-11	RES-CHIP	1K 5% 1/10W	R571	1-214-842-11	METAL	120 1% 1/2W
R502	1-216-025-11	RES-CHIP	100 5% 1/10W	R572	1-216-025-11	RES-CHIP	100 5% 1/10W
R503	1-216-033-00	RES-CHIP	220 5% 1/10W	R573	1-216-057-00	RES-CHIP	2.2K 5% 1/10W
R504	1-216-073-00	RES-CHIP	10K 5% 1/10W	R574	1-216-295-11	SHORT	0
R505	1-216-081-00	RES-CHIP	22K 5% 1/10W	R575	1-216-041-00	RES-CHIP	470 5% 1/10W
R506	1-249-393-11	CARBON	10 5% 1/4W	R577	1-163-009-11	CERAMIC CHIP	1000pF 10% 50V
R507	1-249-433-11	CARBON	22K 5% 1/4W	R578	1-216-049-11	RES-CHIP	1K 5% 1/10W
R508	1-215-861-00	METAL OXIDE	47 5% 1W	R579	1-216-049-11	RES-CHIP	1K 5% 1/10W
R509	1-249-381-11	CARBON	1 5% 1/4W	R580	1-249-413-11	CARBON	470 5% 1/4W
R510	1-219-726-11	METAL	2.2 5% 10W	R581	1-249-437-11	CARBON	47K 5% 1/4W
R511	1-216-683-11	METAL CHIP	22K 0.5% 1/10W	R583	1-216-025-11	RES-CHIP	100 5% 1/10W
R512	1-216-057-00	RES-CHIP	2.2K 5% 1/10W	R584	1-215-909-11	METAL OXIDE	47 5% 3W
R513	1-216-423-11	METAL OXIDE	27 5% 1W	R585	1-216-381-11	METAL OXIDE	0.22 5% 3W
R514	1-249-397-11	CARBON	22 5% 1/4W	R586	1-215-909-11	METAL OXIDE	47 5% 3W
R515	1-249-425-11	CARBON	4.7K 5% 1/4W	R588	1-216-065-91	RES-CHIP	4.7K 5% 1/10W
R516	1-216-065-91	RES-CHIP	4.7K 5% 1/10W	R589	1-216-065-91	RES-CHIP	4.7K 5% 1/10W
R517	1-216-089-11	RES-CHIP	47K 5% 1/10W	R590	1-216-065-91	RES-CHIP	4.7K 5% 1/10W
R518	1-216-033-00	RES-CHIP	220 5% 1/10W	R591	1-249-425-11	CARBON	4.7K 5% 1/4W
R519	1-216-037-00	RES-CHIP	330 5% 1/10W	R592	1-249-425-11	CARBON	4.7K 5% 1/4W
R520	1-216-033-00	RES-CHIP	220 5% 1/10W	R593	1-216-073-00	RES-CHIP	10K 5% 1/10W
R521	1-247-807-31	CARBON	100 5% 1/4W	R594	1-216-065-91	RES-CHIP	4.7K 5% 1/10W
R522	1-216-049-11	RES-CHIP	1K 5% 1/10W	R596	1-247-807-31	CARBON	100 5% 1/4W
R523	1-216-685-11	METAL CHIP	27K 0.5% 1/10W	R598	1-216-665-11	METAL CHIP	3.9K 0.5% 1/10W
R524	1-216-663-11	METAL CHIP	3.3K 0.5% 1/10W	R599	1-216-699-91	METAL CHIP	100K 0.5% 1/10W
R525	1-216-657-11	METAL CHIP	1.8K 0.5% 1/10W	R601	△1-220-825-91	CARBON	330K 5% 1/2W
R526	1-216-691-11	METAL CHIP	47K 0.5% 1/10W	R610	1-217-152-00	METAL	0.33 10% 2W
R527	1-216-683-11	METAL CHIP	22K 0.5% 1/10W	R611	1-217-153-00	METAL	0.47 10% 2W
R528	1-215-453-00	METAL	22K 1% 1/4W	R612	1-247-807-31	CARBON	100 5% 1/4W
R530	1-216-662-11	METAL CHIP	3K 0.5% 1/10W	R614	1-247-807-31	CARBON	100 5% 1/4W
R531	1-216-661-11	METAL CHIP	2.7K 0.5% 1/10W	R615	1-249-427-11	CARBON	6.8K 5% 1/4W
R532	1-216-081-00	RES-CHIP	22K 5% 1/10W	R617	1-216-073-00	RES-CHIP	10K 5% 1/10W
R533	1-216-681-11	METAL CHIP	18K 0.5% 1/10W	R618	1-216-049-11	RES-CHIP	1K 5% 1/10W
R534	1-216-057-00	RES-CHIP	2.2K 5% 1/10W	R620	1-202-933-61	FUSE	0.1 10% 1/2W
R536	1-215-863-11	METAL OXIDE	100 5% 1W	R629	1-216-679-11	METAL CHIP	15K 0.5% 1/10W
R537	1-216-659-11	METAL CHIP	2.2K 0.5% 1/10W				[U/C]
R541	1-216-089-11	RES-CHIP	47K 5% 1/10W	R629	1-216-671-11	METAL CHIP	6.8K 0.5% 1/10W
R542	1-214-842-11	METAL	120 1% 1/2W				[NH, SH, EQ]
R545	1-216-057-00	RES-CHIP	2.2K 5% 1/10W	R630	1-249-381-11	CARBON	1 5% 1/4W
R546	1-215-890-11	METAL OXIDE	470 5% 2W	R631	1-216-349-00	METAL OXIDE	1 5% 1W
R547	1-215-387-00	METAL	39 1% 1/4W				[U/C]
R548	1-260-320-11	CARBON	220 5% 1/2W	R631	1-216-369-00	METAL OXIDE	1 5% 2W
R549	1-260-312-11	CARBON	47 5% 1/2W				[NH, SH, EQ]
R550	1-247-903-00	CARBON	1M 5% 1/4W	R632	1-216-081-00	RES-CHIP	22K 5% 1/10W
R552	1-249-437-11	CARBON	47K 5% 1/4W	R633	1-249-406-11	CARBON	120 5% 1/4W
R553	1-249-437-11	CARBON	47K 5% 1/4W	R634	1-249-417-11	CARBON	1K 5% 1/4W
R555	1-249-437-11	CARBON	47K 5% 1/4W	R635	1-260-135-11	CARBON	1M 5% 1/2W
R557	1-249-437-11	CARBON	47K 5% 1/4W	R636	1-260-135-11	CARBON	1M 5% 1/2W
R559	1-249-437-11	CARBON	47K 5% 1/4W	R637	1-216-069-00	RES-CHIP	6.8K 5% 1/10W
R561	1-249-437-11	CARBON	47K 5% 1/4W	R638	1-216-073-00	RES-CHIP	10K 5% 1/10W
R563	1-216-025-11	RES-CHIP	100 5% 1/10W	R639	1-249-419-11	CARBON	1.5K 5% 1/4W
R564	1-216-049-11	RES-CHIP	1K 5% 1/10W	R640	1-249-420-11	CARBON	1.8K 5% 1/4W
R565	1-216-025-11	RES-CHIP	100 5% 1/10W	R641	1-216-073-00	RES-CHIP	10K 5% 1/10W
R566	1-216-025-11	RES-CHIP	100 5% 1/10W	R642	1-249-393-11	CARBON	10 5% 1/4W
R567	1-216-025-11	RES-CHIP	100 5% 1/10W	R643	1-243-979-71	METAL OXIDE	0.1 5% 2W
R568	1-216-025-11	RES-CHIP	100 5% 1/10W	R645	1-216-073-00	RES-CHIP	10K 5% 1/10W
R570	1-214-842-11	METAL	120 1% 1/2W	R646	1-216-001-00	RES-CHIP	10 5% 1/10W
				R647	1-219-512-11	CARBON	2.2M 5% 1/2W



Les composants identifiés par la marque  $\Delta$  sont critiques pour la sécurité. Ne les remplacer que par une pièce portant le numéro spécifié.

The components identified  $\Delta$  marked are critical for safety. Replace only with the part number specified.

REF.NO.	PART NO.	DESCRIPTION	REMARK	REF.NO.	PART NO.	DESCRIPTION	REMARK
R651	1-215-421-00	METAL	1K 1% 1/4W	R742	1-216-668-11	METAL CHIP	5.1K 0.5% 1/10W
R652	1-216-081-00	RES-CHIP	22K 5% 1/10W	R743	1-216-037-00	RES-CHIP	330 5% 1/10W
R653	1-216-671-11	METAL CHIP	6.8K 0.5% 1/10W	R744	1-249-413-11	CARBON	470 5% 1/4W
R654	1-216-017-91	RES-CHIP	47 5% 1/10W	R745	1-249-389-11	CARBON	4.7 5% 1/4W
R655	1-216-049-11	RES-CHIP	1K 5% 1/10W	R746	1-249-389-11	CARBON	4.7 5% 1/4W
R656	1-216-025-11	RES-CHIP	100 5% 1/10W	R747	1-215-881-11	METAL OXIDE	15 5% 2W
R660	1-216-667-11	METAL CHIP	4.7K 0.5% 1/10W	R748	1-219-510-11	CARBON	470K 5% 1/2W
R661	1-216-295-11	SHORT	0	R749	1-216-057-00	RES-CHIP	2.2K 5% 1/10W
R665	1-249-421-11	CARBON	2.2K 5% 1/4W	R753	1-249-393-11	CARBON	10 5% 1/4W
R670	1-216-679-11	METAL CHIP	15K 0.5% 1/10W	R754	1-216-675-91	METAL CHIP	10K 0.5% 1/10W
R671	1-216-675-91	METAL CHIP	10K 0.5% 1/10W	R755	1-216-673-11	METAL CHIP	8.2K 0.5% 1/10W
R675	1-219-512-11	CARBON	2.2M 5% 1/2W	R756	1-249-421-11	CARBON	2.2K 5% 1/4W
R676	1-218-756-11	METAL CHIP	150K 0.5% 1/10W	R757	1-216-073-00	RES-CHIP	10K 5% 1/10W
R686	1-216-033-00	RES-CHIP	220 5% 1/10W	R758	1-249-385-11	CARBON	2.2 5% 1/4W
R687	1-216-081-00	RES-CHIP	22K 5% 1/10W	R759	1-249-385-11	CARBON	2.2 5% 1/4W
R691	1-244-160-91	METAL	36K 0.5% 1/4W	R760	1-216-093-91	RES-CHIP	68K 5% 1/10W
R692	1-244-160-91	METAL	36K 0.5% 1/4W	R901	1-216-097-11	RES-CHIP	100K 5% 1/10W
R693	1-244-160-91	METAL	36K 0.5% 1/4W	R902	1-216-089-11	RES-CHIP	47K 5% 1/10W
R694	1-243-985-91	METAL	33K 0.5% 1/4W	R903	1-218-758-11	METAL CHIP	180K 0.5% 1/10W
R696	1-260-092-11	CARBON	270 5% 1/2W	R904	1-216-057-00	RES-CHIP	2.2K 5% 1/10W
R698	1-216-679-11	METAL CHIP	15K 0.5% 1/10W	R905	1-216-049-11	RES-CHIP	1K 5% 1/10W
R699	1-216-647-11	METAL CHIP	680 0.5% 1/10W	R907	1-216-065-91	RES-CHIP	4.7K 5% 1/10W
R700	1-216-095-00	RES-CHIP	82K 5% 1/10W	R908	1-249-429-11	CARBON	10K 5% 1/4W
R701	1-249-385-11	CARBON	2.2 5% 1/4W	R909	1-219-727-11	METAL	68 5% 10W
R702	1-216-073-00	RES-CHIP	10K 5% 1/10W	R911	1-249-401-11	CARBON	47 5% 1/4W
R703	1-249-385-11	CARBON	2.2 5% 1/4W	R912	1-216-049-11	RES-CHIP	1K 5% 1/10W
R704	1-216-049-11	RES-CHIP	1K 5% 1/10W	R914	1-216-041-00	RES-CHIP	470 5% 1/10W
R706	1-215-887-00	METAL OXIDE	150 5% 2W	R915	1-249-397-11	CARBON	22 5% 1/4W
R707	1-249-440-11	CARBON	82K 5% 1/4W	R916	1-249-401-11	CARBON	47 5% 1/4W
R709	1-216-065-91	RES-CHIP	4.7K 5% 1/10W	R917	1-249-385-11	CARBON	2.2 5% 1/4W
R710	1-216-673-11	METAL CHIP	8.2K 0.5% 1/10W	R918	1-214-935-00	METAL	820K 1% 1/2W
R711	1-216-674-11	METAL CHIP	9.1K 0.5% 1/10W	R919	1-216-073-00	RES-CHIP	10K 5% 1/10W
R712	1-249-425-11	CARBON	4.7K 5% 1/4W	R920	1-216-693-11	METAL CHIP	56K 0.5% 1/10W
R713	1-215-887-00	METAL OXIDE	150 5% 2W	R921	1-249-425-11	CARBON	4.7K 5% 1/4W
R716	1-249-385-11	CARBON	2.2 5% 1/4W	R923	1-215-467-00	METAL	82K 1% 1/4W
R717	1-249-385-11	CARBON	2.2 5% 1/4W	R924	1-216-675-91	METAL CHIP	10K 0.5% 1/10W
R718	1-215-866-11	METAL OXIDE	330 5% 1W	R925	1-218-762-11	METAL CHIP	270K 0.5% 1/10W
R719	1-216-373-11	METAL OXIDE	2.2 5% 2W	R926	1-216-083-00	RES-CHIP	27K 5% 1/10W
R721	1-216-675-91	METAL CHIP	10K 0.5% 1/10W	R927	1-219-748-11	CARBON	4.7K 5% 1/2W
R722	1-215-866-11	METAL OXIDE	330 5% 1W	R928	1-220-825-11	CARBON	330K 5% 1/2W
R724	1-216-675-91	METAL CHIP	10K 0.5% 1/10W	R929	1-216-089-11	RES-CHIP	47K 5% 1/10W
R725	1-216-373-11	METAL OXIDE	2.2 5% 2W	R931	1-219-748-11	CARBON	4.7K 5% 1/2W
R726	1-216-673-11	METAL CHIP	8.2K 0.5% 1/10W	R932	1-216-665-11	METAL CHIP	3.9K 0.5% 1/10W
R727	1-216-673-11	METAL CHIP	8.2K 0.5% 1/10W	R933	1-216-661-11	METAL CHIP	2.7K 0.5% 1/10W
R728	1-216-675-91	METAL CHIP	10K 0.5% 1/10W	R934	1-260-300-11	CARBON	4.7 5% 1/2W
R729	1-216-673-11	METAL CHIP	8.2K 0.5% 1/10W	R935	1-215-433-00	METAL	3.3K 1% 1/4W
R731	1-216-081-00	RES-CHIP	22K 5% 1/10W	R936	1-219-398-51	METAL	2.2M 5% 1W
R732	1-249-383-11	CARBON	1.5 5% 1/4W	R937	1-216-049-11	RES-CHIP	1K 5% 1/10W
R733	1-215-859-00	METAL OXIDE	22 5% 1W	R938	1-216-111-00	RES-CHIP	390K 5% 1/10W
R734	1-215-865-11	METAL OXIDE	220 5% 1W	R939	1-216-095-00	RES-CHIP	82K 5% 1/10W
R735	1-216-667-11	METAL CHIP	4.7K 0.5% 1/10W	R940	1-216-109-00	RES-CHIP	330K 5% 1/10W
R737	1-216-059-00	RES-CHIP	2.7K 5% 1/10W	R941	1-219-621-91	METAL	22M 10% 1/4W
R738	1-216-069-00	RES-CHIP	6.8K 5% 1/10W	R942	1-216-121-11	RES-CHIP	1M 5% 1/10W
R739	1-249-434-11	CARBON	27K 5% 1/4W	R943	1-216-097-11	RES-CHIP	100K 5% 1/10W
R740	1-216-089-11	RES-CHIP	47K 5% 1/10W	R944	1-216-049-11	RES-CHIP	1K 5% 1/10W
R741	1-216-049-11	RES-CHIP	1K 5% 1/10W				

The components identified  $\Delta$  marked are critical for safety.  
Replace only with the part number specified.

Les composants identifiés par la marque  $\Delta$  sont critiques pour la sécurité.  
Ne les remplacer que par une pièce portant le numéro spécifié.

The components identified by  $\boxtimes$  in this manual have been carefully factory-selected for eachset in order to satisfy regulations regarding X-ray radiation. Should replacement be required, replace only with the value originally used.



REF.NO.	PART NO.	DESCRIPTION	REMARK	REF.NO.	PART NO.	DESCRIPTION	REMARK
R945	1-216-025-11	RES-CHIP	100 5% 1/10W			H1 BOARD, COMPLETE	
R946	1-216-073-00	RES-CHIP	10K 5% 1/10W			*****	
R950	1-216-049-11	RES-CHIP	1K 5% 1/10W				
R951	1-216-097-11	RES-CHIP	100K 5% 1/10W				
R952	1-216-057-00	RES-CHIP	2.2K 5% 1/10W				
						<CAPACITOR>	
R953	1-216-129-00	RES-CHIP	2.2M 5% 1/10W	C1400	1-126-795-11	ELECT 10 $\mu$ F 20% 50V	
R954	1-218-179-11	RES-CHIP	10M 5% 1/10W	C1401	1-126-786-11	ELECT 47 $\mu$ F 20% 16V	
R955	1-218-179-11	RES-CHIP	10M 5% 1/10W	C1402	1-126-786-11	ELECT 47 $\mu$ F 20% 16V	
		<VARIABLE RESISTOR>		C1403	1-137-150-11	MYLAR 0.01 $\mu$ F 5% 50V	
				C1404	1-137-150-11	MYLAR 0.01 $\mu$ F 5% 50V	
$\boxtimes$ RV901 $\Delta$	1-241-767-21	RES, ADJ, CERMET 100K (HV ADJ)		C1405	1-126-786-11	ELECT 47 $\mu$ F 20% 16V	
		<RELAY>		C1407	1-126-786-11	ELECT 47 $\mu$ F 20% 16V	
				C1498	1-130-495-00	MYLAR 0.1 $\mu$ F 5% 50V	
						<CONNECTOR>	
				CN1400	1-564-593-11	PLUG, CONNECTOR 14P	
				CN1401*	1-564-520-11	PLUG, CONNECTOR 5P	
		<SWITCH>				<DIODE>	
S501	1-692-465-11	SWITCH, SLIDE (RASTER CENTER TAP SWITCH)		D1400	8-719-056-13	DIODE SML79423C-TP15 (POWER)	
S601	$\Delta$ 1-771-727-11	SWITCH, AC POWER PUSH (POWER)		D1402	8-719-911-19	DIODE 1SS119-25	
		<SPARK GAP>		D1403	8-719-911-19	DIODE 1SS119-25	
						<FERRITE BEAD>	
SG601	1-533-982-21	SPARK GAP		FB1401	1-412-911-31	FERRITE 1.1 $\mu$ H	
SG901	1-517-499-21	SPARK GAP		FB1402	1-412-911-31	FERRITE 1.1 $\mu$ H	
SG902	1-519-422-11	SPARK GAP		FB1403	1-412-911-31	FERRITE 1.1 $\mu$ H	
SG903	1-519-422-11	SPARK GAP				<TRANSISTOR>	
		<TRANSFORMER>					
T501	1-435-188-11	TRANSFORMER, FERRITE (HDT)		Q1400	8-729-029-66	TRANSISTOR DTC114ESA	
T503	1-435-140-21	TRANSFORMER, FERRITE (LCT)		Q1401	8-729-029-68	TRANSISTOR DTC114TSA	
T504	1-431-413-11	TRANSFORMER, FERRITE (HST)		Q1402	8-729-029-40	TRANSISTOR DTA124ESA	
T601	$\Delta$ 1-429-180-11	TRANSFORMER, LINE FILTER				<RESISTOR>	
T620	1-435-748-11	TRANSFORMER, CONVERTER (PIT)					
T630	1-435-751-11	TRANSFORMER, CONVERTER (SRT)		R1400	1-215-405-00	METAL 220 1% 1/4W	
T701	1-435-129-11	TRANSFORMER, FERRITE (DFT)		R1401	1-215-405-00	METAL 220 1% 1/4W	
T901	$\Delta$ 1-453-359-11	TRANSFORMER ASSY, FLYBACK (NX-4702/KM7E)		R1402	1-215-397-00	METAL 100 1% 1/4W	
T902	1-411-567-31	INDUCTOR 500 $\mu$ H		R1403	1-215-397-00	METAL 100 1% 1/4W	
		<THERMISTOR>		R1404	1-215-413-00	METAL 470 1% 1/4W	
				R1405	1-249-441-11	CARBON 100K 5% 1/4W	
				R1406	1-249-407-11	CARBON 150 5% 1/4W	
TH401	1-807-970-11	THERMISTOR		R1407	1-249-409-11	CARBON 220 5% 1/4W	
TH601	$\Delta$ 1-803-546-11	THERMISTOR (NTH22D6R0QA)		R1408	1-249-413-11	CARBON 470 5% 1/4W	
THP602	$\Delta$ 1-809-827-11	THERMISTOR, POSITIVE		R1409	1-249-441-11	CARBON 100K 5% 1/4W	
		<VARISTOR>					
				R1419	1-249-441-11	CARBON 100K 5% 1/4W	
VDR601	$\Delta$ 1-803-918-51	VARISTOR (TNR14V621K660)		R1420	1-249-429-11	CARBON 10K 5% 1/4W	
VDR602	$\Delta$ 1-810-622-21	VARISTOR		R1421	1-215-445-00	METAL 10K 1% 1/4W	
				R1422	1-249-433-11	CARBON 22K 5% 1/4W	
				R1423	1-249-433-11	CARBON 22K 5% 1/4W	
				R1424	1-215-453-00	METAL 22K 1% 1/4W	



CPD-G520



REF.NO.	PART NO.	DESCRIPTION	REMARK	REF.NO.	PART NO.	DESCRIPTION	REMARK
		<SWITCH>		FB1601	1-412-911-11	FERRITE	1.1μH
S1400	1-762-196-21	SWITCH, TACT (MENU)		FB1602	1-412-911-11	FERRITE	1.1μH
S1401	1-762-196-21	SWITCH, TACT (PICTURE MODE)		FB1603	1-412-911-11	FERRITE	1.1μH
S1402	1-771-734-11	SWITCH, TACTILE		FB1604	1-412-911-11	FERRITE	1.1μH
		(CONTROL/CONTRAST)				<IC>	
S1403	1-571-427-11	SWITCH, SLIDE (INPUT1/INPUT2)		IC1600	8-759-822-38	IC LA6510	
		<THERMISTOR>		IC1601	8-759-822-38	IC LA6510	
TH1400	1-807-796-11	THERMISTOR		IC1602	8-759-426-18	IC MB88141PF-ER	
				IC1603	8-759-803-42	IC LA6500-FA	
				IC1604	8-759-822-38	IC LA6510	
				IC1605	8-759-711-59	IC NJM78L05UA-TE1	
*****						<RESISTOR>	
		L2 BOARD, COMPLETE		R1600	1-216-073-00	RES-CHIP	10K 5% 1/10W
		*****		R1601	1-216-308-00	RES-CHIP	4.7 5% 1/10W
				R1603	1-216-308-00	RES-CHIP	4.7 5% 1/10W
				R1604	1-216-073-00	RES-CHIP	10K 5% 1/10W
				R1605	1-215-859-00	METAL OXIDE	22 5% 1W
		<CAPACITOR>		R1607	1-215-859-00	METAL OXIDE	22 5% 1W
C1600	1-164-004-11	CERAMIC CHIP 0.1μF	10% 25V	R1608	1-216-071-00	RES-CHIP	8.2K 5% 1/10W
C1604	1-163-003-11	CERAMIC CHIP 330pF	10% 50V	R1609	1-216-065-91	RES-CHIP	4.7K 5% 1/10W
C1605	1-163-021-91	CERAMIC CHIP 0.01μF	10% 50V	R1610	1-216-071-00	RES-CHIP	8.2K 5% 1/10W
C1606	1-163-021-91	CERAMIC CHIP 0.01μF	10% 50V	R1611	1-215-859-00	METAL OXIDE	22 5% 1W
C1607	1-163-003-11	CERAMIC CHIP 330pF	10% 50V	R1613	1-216-308-00	RES-CHIP	4.7 5% 1/10W
C1608	1-164-004-11	CERAMIC CHIP 0.1μF	10% 25V	R1617	1-216-065-91	RES-CHIP	4.7K 5% 1/10W
C1611	1-163-021-91	CERAMIC CHIP 0.01μF	10% 50V	R1621	1-216-308-00	RES-CHIP	4.7 5% 1/10W
C1613	1-163-021-91	CERAMIC CHIP 0.01μF	10% 50V	R1624	1-216-073-00	RES-CHIP	10K 5% 1/10W
C1614	1-163-021-91	CERAMIC CHIP 0.01μF	10% 50V	R1625	1-216-073-00	RES-CHIP	10K 5% 1/10W
C1617	1-164-004-11	CERAMIC CHIP 0.1μF	10% 25V	R1626	1-215-859-00	METAL OXIDE	22 5% 1W
C1618	1-164-004-11	CERAMIC CHIP 0.1μF	10% 25V	R1628	1-216-073-00	RES-CHIP	10K 5% 1/10W
C1619	1-163-038-11	CERAMIC CHIP 0.1μF	10% 25V	R1629	1-216-073-00	RES-CHIP	10K 5% 1/10W
C1621	1-164-004-11	CERAMIC CHIP 0.1μF	10% 25V	R1630	1-215-859-00	METAL OXIDE	22 5% 1W
C1622	1-164-004-11	CERAMIC CHIP 0.1μF	10% 25V	R1631	1-216-073-00	RES-CHIP	10K 5% 1/10W
C1623	1-115-339-11	CERAMIC CHIP 0.1μF	10% 50V	R1634	1-216-308-00	RES-CHIP	4.7 5% 1/10W
C1627	1-115-339-11	CERAMIC CHIP 0.1μF	10% 50V	R1635	1-216-077-91	RES-CHIP	15K 5% 1/10W
C1628	1-104-664-11	ELECT 47μF	20% 25V	R1636	1-215-859-00	METAL OXIDE	22 5% 1W
C1629	1-163-021-91	CERAMIC CHIP 0.01μF	10% 50V	R1640	1-216-065-91	RES-CHIP	4.7K 5% 1/10W
C1632	1-104-664-11	ELECT 47μF	20% 25V	R1641	1-216-079-00	RES-CHIP	18K 5% 1/10W
C1633	1-126-791-11	ELECT 10μF	20% 16V	R1643	1-216-308-00	RES-CHIP	4.7 5% 1/10W
C1637	1-164-004-11	CERAMIC CHIP 0.1μF	10% 25V	R1644	1-216-053-00	RES-CHIP	1.5K 5% 1/10W
C1638	1-164-004-11	CERAMIC CHIP 0.1μF	10% 25V	R1647	1-216-073-00	RES-CHIP	10K 5% 1/10W
C1639	1-104-664-11	ELECT 47μF	20% 25V	R1648	1-216-073-00	RES-CHIP	10K 5% 1/10W
C1640	1-104-664-11	ELECT 47μF	20% 25V	R1649	1-215-859-00	METAL OXIDE	22 5% 1W
		<CONNECTOR>		R1650	1-249-382-11	CARBON	1.2 5% 1/4W
CN1600	1-564-505-11	PLUG, CONNECTOR	2P	R1651	1-249-382-11	CARBON	1.2 5% 1/4W
CN1601*	1-564-507-11	PLUG, CONNECTOR	4P	R1652	1-249-382-11	CARBON	1.2 5% 1/4W
CN1602*	1-564-511-11	PLUG, CONNECTOR	8P	R1653	1-249-382-11	CARBON	1.2 5% 1/4W
		<FERRITE BEAD>		R1654	1-216-025-11	RES-CHIP	100 5% 1/10W
FB1600	1-412-911-11	FERRITE	1.1μH	R1655	1-216-025-11	RES-CHIP	100 5% 1/10W



REF.NO.	PART NO.	DESCRIPTION	REMARK	REF.NO.	PART NO.	DESCRIPTION	REMARK
N BOARD, COMPLETE *****				<RESISTOR>			
<CAPACITOR>				R1001	1-216-125-00	RES-CHIP 1.5M 5% 1/10W	
C1001	1-163-021-91	CERAMIC CHIP 0.01μF	10% 50V	R1003	1-216-025-11	RES-CHIP 100 5% 1/10W	
C1002	1-163-021-91	CERAMIC CHIP 0.01μF	10% 50V	R1004	1-216-065-91	RES-CHIP 4.7K 5% 1/10W	
C1004	1-163-021-91	CERAMIC CHIP 0.01μF	10% 50V	R1005	1-216-065-91	RES-CHIP 4.7K 5% 1/10W	
C1005	1-163-021-91	CERAMIC CHIP 0.01μF	10% 50V	R1006	1-216-113-00	RES-CHIP 470K 5% 1/10W	
C1014	1-126-205-11	ELECT 47μF	20% 6.3V	R1008	1-216-025-11	RES-CHIP 100 5% 1/10W	
C1015	1-163-021-91	CERAMIC CHIP 0.01μF	10% 50V	R1009	1-216-025-11	RES-CHIP 100 5% 1/10W	
C1016	1-163-021-91	CERAMIC CHIP 0.01μF	10% 50V	R1010	1-216-049-11	RES-CHIP 1K 5% 1/10W	
C1017	1-163-021-91	CERAMIC CHIP 0.01μF	10% 50V	R1011	1-216-065-91	RES-CHIP 4.7K 5% 1/10W	
C1018	1-163-220-11	CERAMIC CHIP 3pF	0.25pF 50V	R1012	1-216-065-91	RES-CHIP 4.7K 5% 1/10W	
C1019	1-163-235-11	CERAMIC CHIP 22pF	5% 50V	R1014	1-216-065-91	RES-CHIP 4.7K 5% 1/10W	
C1020	1-126-206-11	ELECT 100μF	20% 6.3V	R1015	1-216-065-91	RES-CHIP 4.7K 5% 1/10W	
C1021	1-163-021-91	CERAMIC CHIP 0.01μF	10% 50V	R1016	1-216-025-11	RES-CHIP 100 5% 1/10W	
C1022	1-163-021-91	CERAMIC CHIP 0.01μF	10% 50V	R1017	1-216-049-11	RES-CHIP 1K 5% 1/10W	
C1023	1-163-021-91	CERAMIC CHIP 0.01μF	10% 50V	R1018	1-216-017-91	RES-CHIP 47 5% 1/10W	
C1027	1-163-021-91	CERAMIC CHIP 0.01μF	10% 50V	R1019	1-216-017-91	RES-CHIP 47 5% 1/10W	
C1028	1-164-004-11	CERAMIC CHIP 0.1μF	10% 25V	R1020	1-216-017-91	RES-CHIP 47 5% 1/10W	
C1029	1-109-982-11	CERAMIC CHIP 1μF	10% 10V	R1021	1-216-017-91	RES-CHIP 47 5% 1/10W	
C1030	1-163-021-91	CERAMIC CHIP 0.01μF	10% 50V	R1022	1-216-065-91	RES-CHIP 4.7K 5% 1/10W	
<CONNECTOR>				R1023	1-216-065-91	RES-CHIP 4.7K 5% 1/10W	
CN1003	1-564-521-11	PLUG, CONNECTOR	6P	R1040	1-216-025-11	RES-CHIP 100 5% 1/10W	
<DIODE>				R1041	1-216-065-91	RES-CHIP 4.7K 5% 1/10W	
D1001	8-719-073-01	DIODE MA111-(K8).S0		R1042	1-216-073-00	RES-CHIP 10K 5% 1/10W	
<FERRITE BEAD>				R1043	1-216-121-11	RES-CHIP 1M 5% 1/10W	
FB1001	1-543-963-22	FERRITE		R1044	1-216-121-11	RES-CHIP 1M 5% 1/10W	
FB1002	1-216-295-11	SHORT	0	<COMPOSITION CIRCUIT BLOCK>			
FB1003	1-216-295-11	SHORT	0	RB1001	1-233-576-11	NETWORK, RESISTOR (CHIP) 100	
FB1004	1-216-295-11	SHORT	0	RB1002	1-233-576-11	NETWORK, RESISTOR (CHIP) 100	
FB1005	1-216-295-11	SHORT	0	RB1003	1-233-576-11	NETWORK, RESISTOR (CHIP) 100	
FB1006	1-216-295-11	SHORT	0	RB1004	1-233-576-11	NETWORK, RESISTOR (CHIP) 100	
FB1007	1-216-295-11	SHORT	0	RB1005	1-233-576-11	NETWORK, RESISTOR (CHIP) 100	
<IC>				RB1006	1-233-576-11	NETWORK, RESISTOR (CHIP) 100	
IC1001	8-759-826-97	IC TMP91PW18F-1A22(Z)		RB1007	1-233-576-11	NETWORK, RESISTOR (CHIP) 100	
IC1002	8-759-420-77	IC PST574CMT-T1		RB1009	1-233-576-11	NETWORK, RESISTOR (CHIP) 100	
IC1003	8-759-641-86	IC BR24C16F-E2		<CRYSTAL>			
<TRANSISTOR>				X1001	1-795-044-21	VIBRATOR, CRYSTAL (16.9344MHz)	
Q1001	8-729-029-06	TRANSISTOR DTC124EUA-T106		*****			
<CAPACITOR>				US BOARD, COMPLETE [NH, SH, EQ] *****			
C2601	1-163-021-91	CERAMIC CHIP 0.01μF	10% 50V	<CAPACITOR>			
C2602	1-126-964-11	ELECT 10μF	20% 50V	C2601	1-163-021-91	CERAMIC CHIP 0.01μF	10% 50V
C2603	1-126-964-11	ELECT 10μF	20% 50V	C2602	1-126-964-11	ELECT 10μF	20% 50V
				C2603	1-126-964-11	ELECT 10μF	20% 50V



REF.NO.	PART NO.	DESCRIPTION	REMARK	REF.NO.	PART NO.	DESCRIPTION	REMARK
C2604	1-126-964-11	ELECT	10μF 20% 50V	<FERRITE BEAD>			
C2605	1-126-964-11	ELECT	10μF 20% 50V	FB2601	1-412-911-31	FERRITE	1.1μH
C2606	1-126-934-11	ELECT	220μF 20% 10V	FB2602	1-410-397-21	FERRITE	1.1μH
C2607	1-126-934-11	ELECT	220μF 20% 10V	FB2901	1-412-911-31	FERRITE	1.1μH
C2608	1-126-934-11	ELECT	220μF 20% 10V	FB2903	1-412-911-31	FERRITE	1.1μH
C2609	1-126-934-11	ELECT	220μF 20% 10V	FB2904	1-412-911-31	FERRITE	1.1μH
C2610	1-104-664-11	ELECT	47μF 20% 25V	FB2905	1-412-911-31	FERRITE	1.1μH
C2611	1-104-664-11	ELECT	47μF 20% 25V	FB2906	1-412-911-31	FERRITE	1.1μH
C2612	1-163-021-91	CERAMIC CHIP	0.01μF 10% 50V	FB2911	1-412-911-31	FERRITE	1.1μH
C2901	1-164-004-11	CERAMIC CHIP	0.1μF 10% 25V	FB2912	1-216-295-11	SHORT	0
C2902	1-104-664-11	ELECT	47μF 20% 25V	FB2913	1-216-295-11	SHORT	0
C2904	1-163-021-91	CERAMIC CHIP	0.01μF 10% 50V	FB2914	1-216-295-11	SHORT	0
C2905	1-164-489-11	CERAMIC CHIP	0.22μF 10% 16V	FB2915	1-216-295-11	SHORT	0
C2906	1-164-489-11	CERAMIC CHIP	0.22μF 10% 16V	FB2916	1-216-295-11	SHORT	0
C2908	1-164-489-11	CERAMIC CHIP	0.22μF 10% 16V	FB2917	1-216-295-11	SHORT	0
C2909	1-163-237-11	CERAMIC CHIP	27pF 5% 50V	FB2918	1-216-295-11	SHORT	0
C2912	1-163-235-11	CERAMIC CHIP	22pF 5% 50V	FB2919	1-216-295-11	SHORT	0
C2914	1-164-489-11	CERAMIC CHIP	0.22μF 10% 16V	FB2924	1-216-295-11	SHORT	0
C2915	1-164-489-11	CERAMIC CHIP	0.22μF 10% 16V	FB2925	1-216-295-11	SHORT	0
C2916	1-164-004-11	CERAMIC CHIP	0.1μF 10% 25V	FB2936	1-414-766-22	INDUCTOR	
C2917	1-164-004-11	CERAMIC CHIP	0.1μF 10% 25V	<IC>			
C2918	1-164-004-11	CERAMIC CHIP	0.1μF 10% 25V	IC2601	8-759-431-14	IC PQ3TZ53U	
C2923	1-163-021-91	CERAMIC CHIP	0.01μF 10% 50V	IC2602	8-749-018-35	IC SLA3006M(LF874)	
<CONNECTOR>				IC2901	8-759-660-89	IC KC82C160SH	
CN2601*	1-564-519-11	PLUG, CONNECTOR	4P	IC2902	8-759-165-87	IC PST600J-T	
CN2901	1-794-989-11	CONNECTOR, USB (B)		<TRANSISTOR>			
CN2902	1-794-990-11	CONNECTOR, USB (A)		Q2601	8-729-029-06	TRANSISTOR DTC124EUA-T106	
CN2903	1-794-990-11	CONNECTOR, USB (A)		Q2602	8-729-029-06	TRANSISTOR DTC124EUA-T106	
CN2904	1-794-990-11	CONNECTOR, USB (A)		Q2603	8-729-029-06	TRANSISTOR DTC124EUA-T106	
CN2905	1-794-990-11	CONNECTOR, USB (A)		Q2604	8-729-029-06	TRANSISTOR DTC124EUA-T106	
<DIODE>				<RESISTOR>			
D2601	8-719-069-55	ZENER DIODE	UDZS-TE-17-5.6B	R2601	1-216-081-00	RES-CHIP	22K 5% 1/10W
D2604	8-719-911-19	DIODE	1SS119-25	R2602	1-216-365-00	METAL OXIDE	0.47 5% 2W
D2605	8-719-911-19	DIODE	1SS119-25	R2603	1-216-365-00	METAL OXIDE	0.47 5% 2W
D2606	8-719-911-19	DIODE	1SS119-25	R2611	1-216-049-11	RES-CHIP	1K 5% 1/10W
D2607	8-719-911-19	DIODE	1SS119-25	R2612	1-216-049-11	RES-CHIP	1K 5% 1/10W
D2902	8-719-422-12	ZENER DIODE	MA8039	R2613	1-216-049-11	RES-CHIP	1K 5% 1/10W
D2903	8-719-422-12	ZENER DIODE	MA8039	R2614	1-216-049-11	RES-CHIP	1K 5% 1/10W
D2904	8-719-069-55	ZENER DIODE	UDZS-TE-17-5.6B	R2618	1-216-073-00	RES-CHIP	10K 5% 1/10W
D2905	8-719-069-55	ZENER DIODE	UDZS-TE-17-5.6B	R2619	1-216-073-00	RES-CHIP	10K 5% 1/10W
D2906	8-719-069-55	ZENER DIODE	UDZS-TE-17-5.6B	R2620	1-216-073-00	RES-CHIP	10K 5% 1/10W
D2907	8-719-069-55	ZENER DIODE	UDZS-TE-17-5.6B	R2621	1-216-073-00	RES-CHIP	10K 5% 1/10W
D2908	8-719-422-12	ZENER DIODE	MA8039	R2622	1-216-033-00	RES-CHIP	220 5% 1/10W
D2909	8-719-422-12	ZENER DIODE	MA8039	R2623	1-216-033-00	RES-CHIP	220 5% 1/10W
D2910	8-719-422-12	ZENER DIODE	MA8039	R2901	1-216-013-00	RES-CHIP	33 5% 1/10W
D2911	8-719-422-12	ZENER DIODE	MA8039	R2902	1-216-057-00	RES-CHIP	2.2K 5% 1/10W
D2912	8-719-422-12	ZENER DIODE	MA8039	R2903	1-216-121-11	RES-CHIP	1M 5% 1/10W
D2913	8-719-422-12	ZENER DIODE	MA8039	R2904	1-216-065-91	RES-CHIP	4.7K 5% 1/10W
D2914	8-719-422-12	ZENER DIODE	MA8039	R2905	1-216-073-00	RES-CHIP	10K 5% 1/10W
D2915	8-719-422-12	ZENER DIODE	MA8039	R2906	1-216-022-00	RES-CHIP	75 5% 1/10W



REF.NO.	PART NO.	DESCRIPTION			REMARK
R2907	1-216-039-00	RES-CHIP	390	5%	1/10W
R2908	1-216-073-00	RES-CHIP	10K	5%	1/10W
R2909	1-216-065-91	RES-CHIP	4.7K	5%	1/10W
R2910	1-216-065-91	RES-CHIP	4.7K	5%	1/10W
R2915	1-216-053-00	RES-CHIP	1.5K	5%	1/10W
R2916	1-216-077-91	RES-CHIP	15K	5%	1/10W
R2919	1-216-077-91	RES-CHIP	15K	5%	1/10W
R2920	1-216-077-91	RES-CHIP	15K	5%	1/10W
R2923	1-216-077-91	RES-CHIP	15K	5%	1/10W
R2924	1-216-077-91	RES-CHIP	15K	5%	1/10W
R2925	1-216-077-91	RES-CHIP	15K	5%	1/10W
R2926	1-216-077-91	RES-CHIP	15K	5%	1/10W
R2927	1-216-013-00	RES-CHIP	33	5%	1/10W
R2928	1-216-013-00	RES-CHIP	33	5%	1/10W
R2930	1-216-009-91	RES-CHIP	22	5%	1/10W
R2931	1-216-009-91	RES-CHIP	22	5%	1/10W
R2932	1-216-077-91	RES-CHIP	15K	5%	1/10W
R2933	1-216-013-00	RES-CHIP	33	5%	1/10W
R2934	1-216-013-00	RES-CHIP	33	5%	1/10W
R2935	1-216-013-00	RES-CHIP	33	5%	1/10W
R2941	1-216-013-00	RES-CHIP	33	5%	1/10W
R2942	1-216-013-00	RES-CHIP	33	5%	1/10W

<CRYSTAL>

X2901 1-767-925-21 VIBRATOR, CRYSTAL (12MHz)

\*\*\*\*\*

