



ON Semiconductor®

www.onsemi.com

CPH5871

Power MOSFET 30V, 52mΩ, 3.5A, Single N-Channel with Schottky Diode

Features

- Composite Type with a N-channel Silicon MOSFET and a Schottky Barrier Diode Contained in One Package Facilitating High-density Mounting
- ESD Diode-Protected Gate
- Pb-Free, Halogen Free and RoHS Compliance
- [MOSFET] • High Speed Switching
 - 1.8V Drive
- [SBD] • Short Reverse Recovery Time
 - Low Forward Voltage

Specifications

Absolute Maximum Ratings at $T_a = 25^\circ\text{C}$

Parameter	Symbol	Value	Unit
[MOSFET]			
Drain to Source Voltage	V_{DSS}	30	V
Gate to Source Voltage	V_{GSS}	± 12	V
Drain Current (DC)	I_D	3.5	A
Drain Current (Pulse) $PW \leq 10\mu\text{s}$, duty cycle $\leq 1\%$	I_{DP}	14	A
Power Dissipation When mounted on ceramic substrate (600mm ² × 0.8mm) 1unit	P_D	0.9	W
Junction Temperature	T_J	150	°C
Storage Temperature	T_{stg}	-55 to +125	°C
[SBD]			
Repetitive Peak Reverse Voltage	V_{RRM}	30	V
Nonrepetitive Peak Reverse Surge Voltage	V_{RSM}	35	V
Average Output Current	I_O	1	A
Surge Forward Current 50Hz sine wave, 1cycle	I_{FSM}	10	A
Junction Temperature	T_J	-55 to +125	°C
Storage Temperature	T_{stg}	-55 to +125	°C

Thermal Resistance Ratings

Parameter	Symbol	Value	Unit
Junction to Ambient When mounted on ceramic substrate (600mm ² × 0.8mm) 1unit	$R_{\theta JA}$	138.8	°C/W

Stresses exceeding those listed in the Maximum Ratings table may damage the device. If any of these limits are exceeded, device functionality should not be assumed, damage may occur and reliability may be affected.

ORDERING INFORMATION

See detailed ordering and shipping information on page 6 of this data sheet.

V_{DSS}	$R_{DS(on)}$ Max	I_D Max
[MOSFET] 30V	52mΩ@ 4.5V	3.5A
	74mΩ@ 2.5V	
	132mΩ@ 1.8V	

Electrical Connection N-Channel

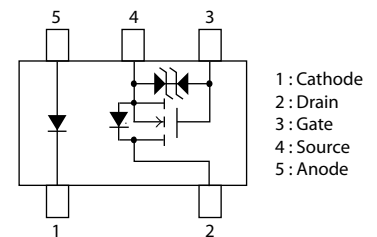

Packing Type : TL

Marking

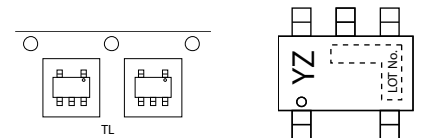

CPH5871

Electrical Characteristics at Ta = 25°C

Parameter	Symbol	Conditions	Value			Unit
			min	typ	max	
[MOSFET]						
Drain to Source Breakdown Voltage	$V_{(BR)DSS}$	$I_D=1mA, V_{GS}=0V$	30			V
Zero-Gate Voltage Drain Current	I_{DSS}	$V_{DS}=30V, V_{GS}=0V$			1	μA
Gate to Source Leakage Current	I_{GSS}	$V_{GS}=\pm 8V, V_{DS}=0V$			± 10	μA
Gate Threshold Voltage	$V_{GS(th)}$	$V_{DS}=10V, I_D=1mA$	0.4		1.3	V
Forward Transconductance	g_{FS}	$V_{DS}=10V, I_D=2A$	2.0	3.4		S
Static Drain to Source On-State Resistance	$R_{DS(on)1}$	$I_D=2A, V_{GS}=4.5V$		40	52	$m\Omega$
	$R_{DS(on)2}$	$I_D=1A, V_{GS}=2.5V$		53	74	$m\Omega$
	$R_{DS(on)3}$	$I_D=0.5A, V_{GS}=1.8V$		82	132	$m\Omega$
Input Capacitance	C_{iss}	$V_{DS}=10V, f=1MHz$		430		pF
Output Capacitance	C_{oss}		59		pF	
Reverse Transfer Capacitance	C_{rss}		38		pF	
Turn-ON Delay Time	$t_{d(on)}$	See specified Test Circuit		10		ns
Rise Time	t_r		41		ns	
Turn-OFF Delay Time	$t_{d(off)}$		36		ns	
Fall Time	t_f		37		ns	
Total Gate Charge	Q_g		$V_{DS}=15V, V_{GS}=4.5V, I_D=3.5A$		4.7	
Gate to Source Charge	Q_{gs}	0.8			nC	
Gate to Drain "Miller" Charge	Q_{gd}	1.1			nC	
Forward Diode Voltage	V_{SD}	$I_S=3.5A, V_{GS}=0V$		0.8	1.2	V
[SBD]						
Reverse Voltage	V_R	$I_R=0.5mA$	30			V
Forward Voltage	V_{F1}	$I_F=0.7A$		0.45	0.5	V
	V_{F2}	$I_F=1A$		0.48	0.53	V
Reverse Current	I_R	$V_R=16V$			15	μA
Interterminal Capacitance	C	$V_R=10V, f=1MHz, 1cycle$		27		pF
Reverse Recovery Time	t_{rr}	$I_F=I_R=100mA$, See specified Test Circuit			10	ns

Product parametric performance is indicated in the Electrical Characteristics for the listed test conditions, unless otherwise noted. Product performance may not be indicated by the Electrical Characteristics if operated under different conditions.

Switching Time Test Circuit (MOSFET)

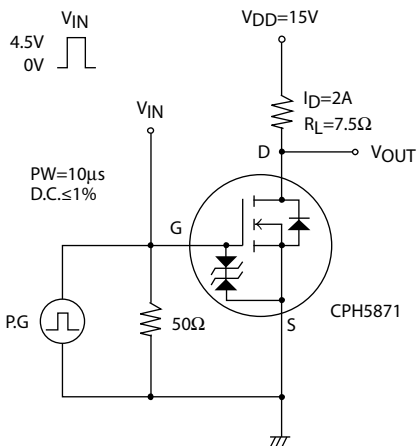

t_{rr} Test Circuit (SBD)

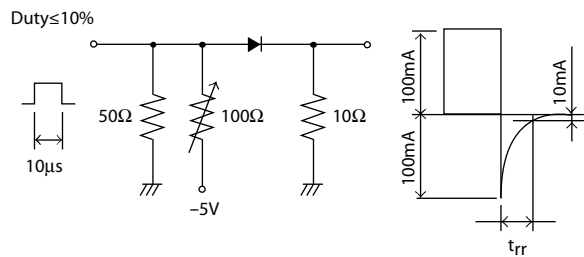

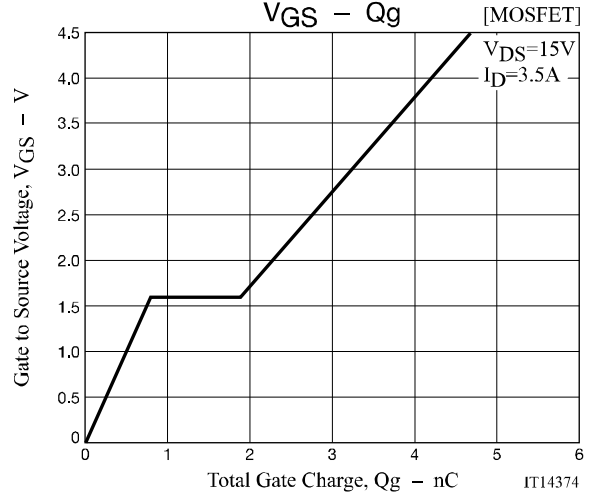
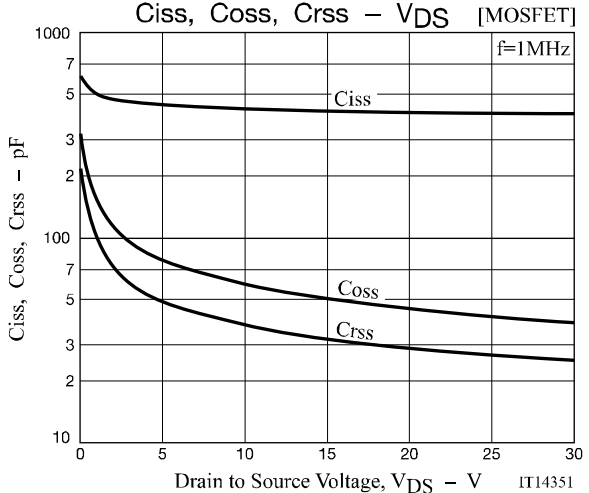
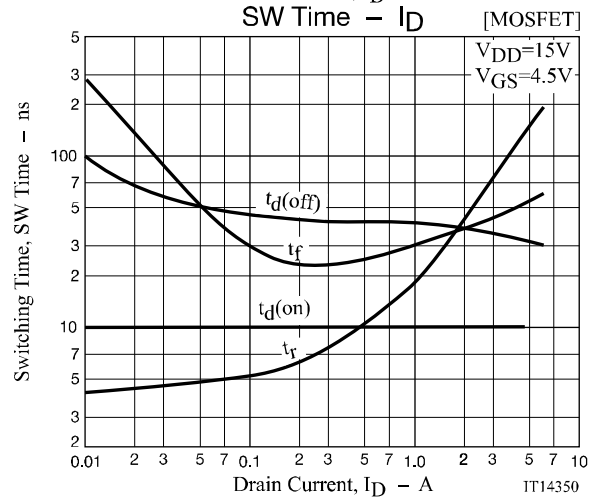
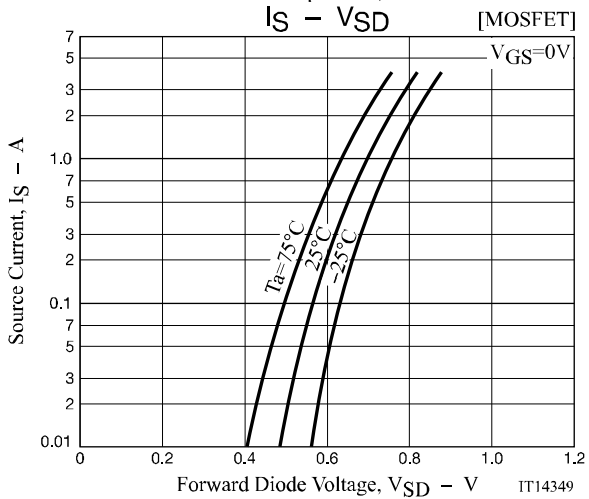
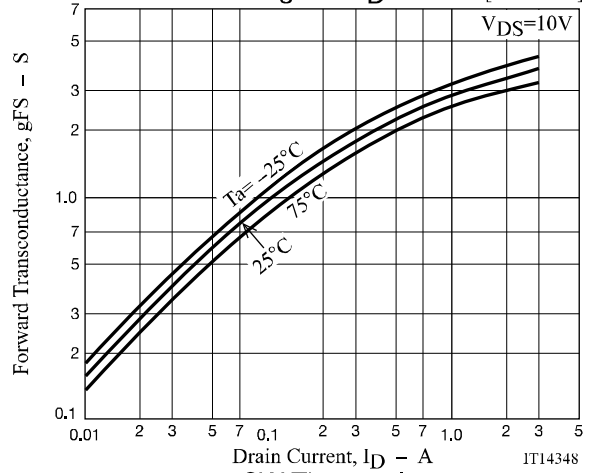
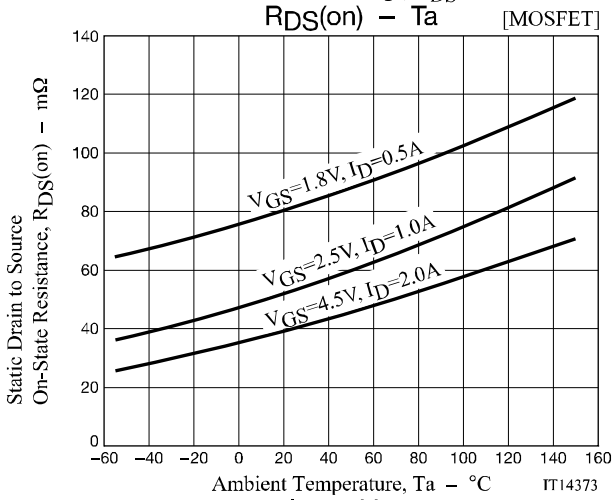
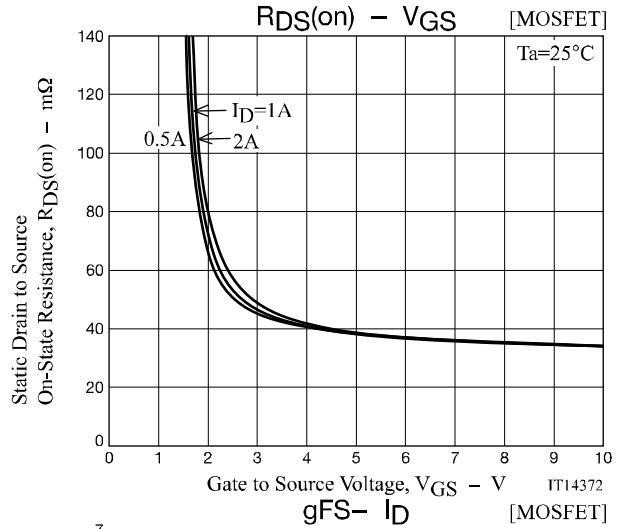
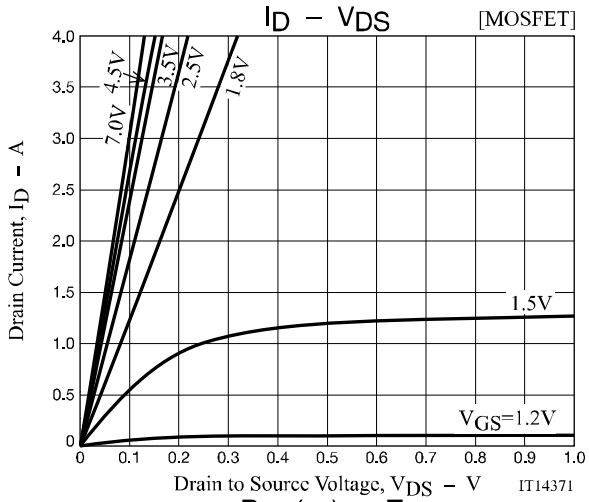

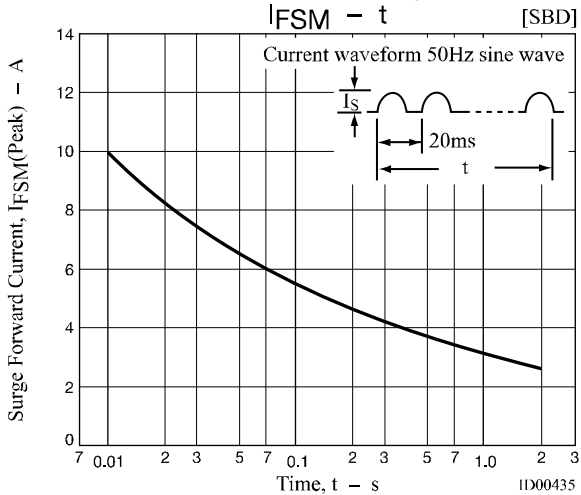
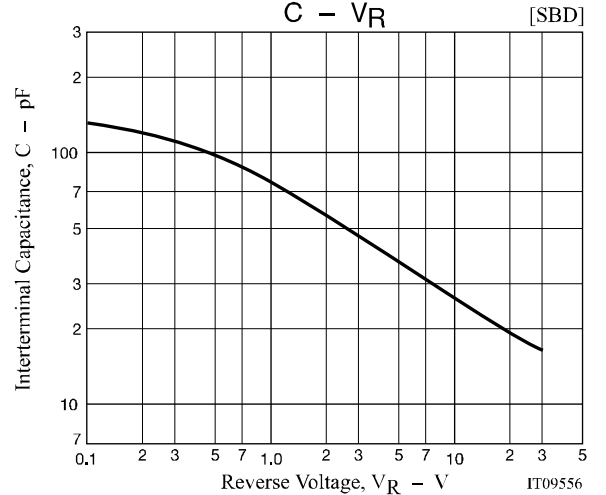
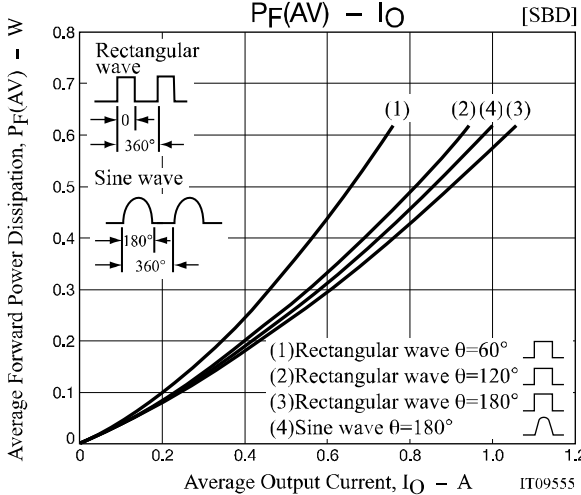
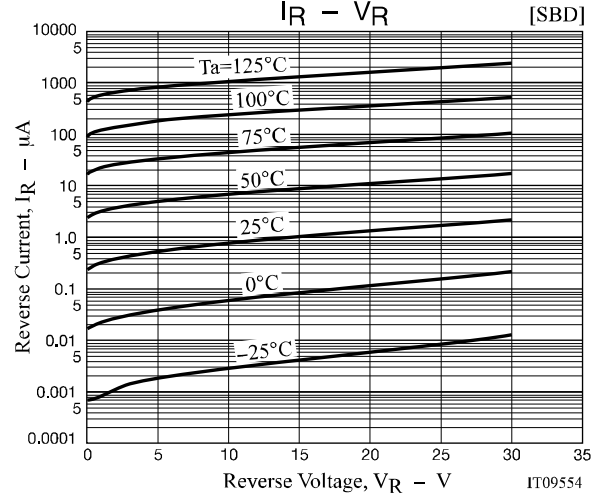
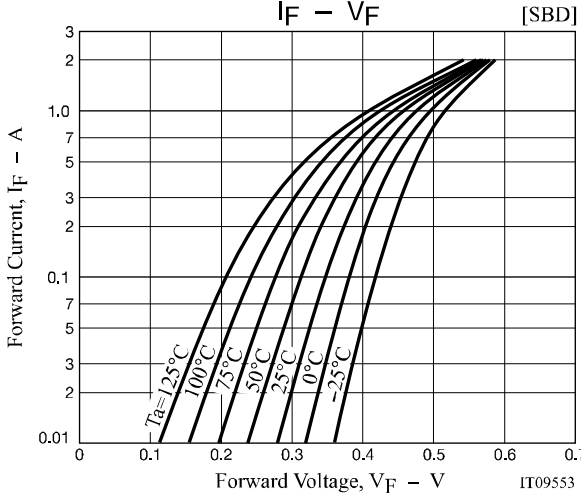
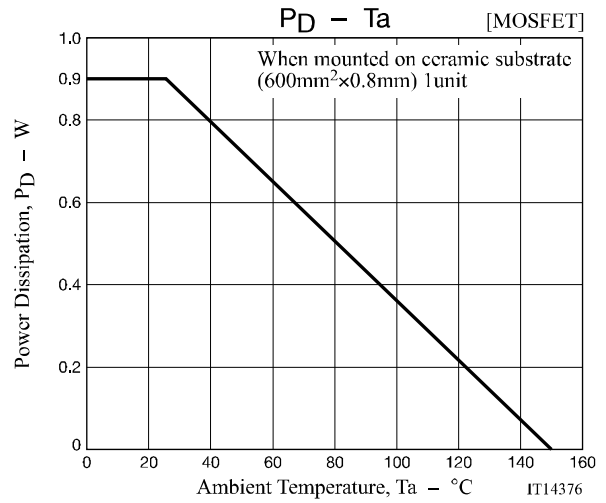
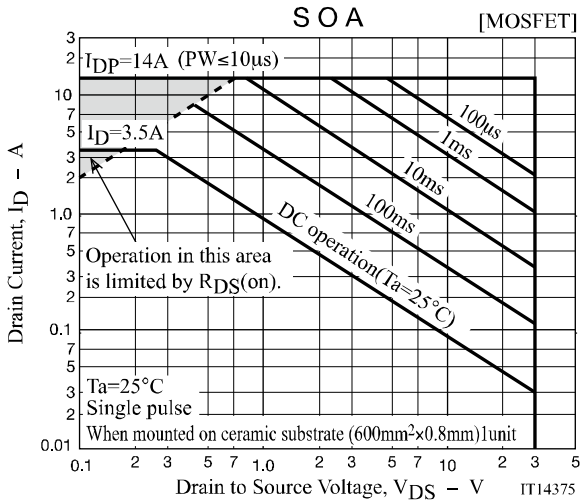

CPH5871

R_{θJA} - Pulse Time

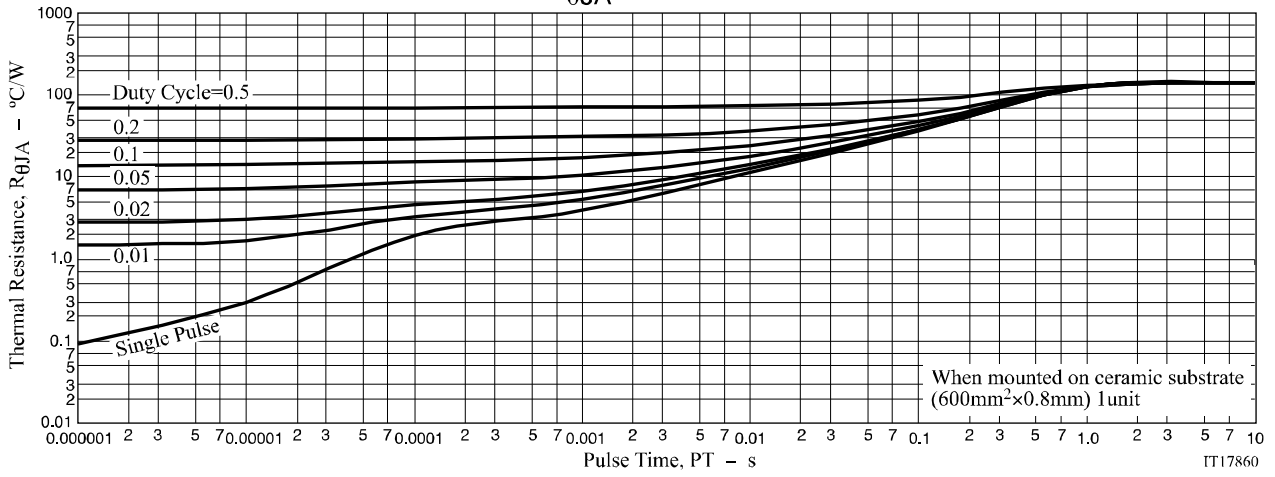

CPH5871

Package Dimensions

CPH5871-TL-H / CPH5871-TL-W

CPH5

CASE 318BC

ISSUE O

unit : mm

- 1 : Cathode
- 2 : Drain
- 3 : Gate
- 4 : Source
- 5 : Anode

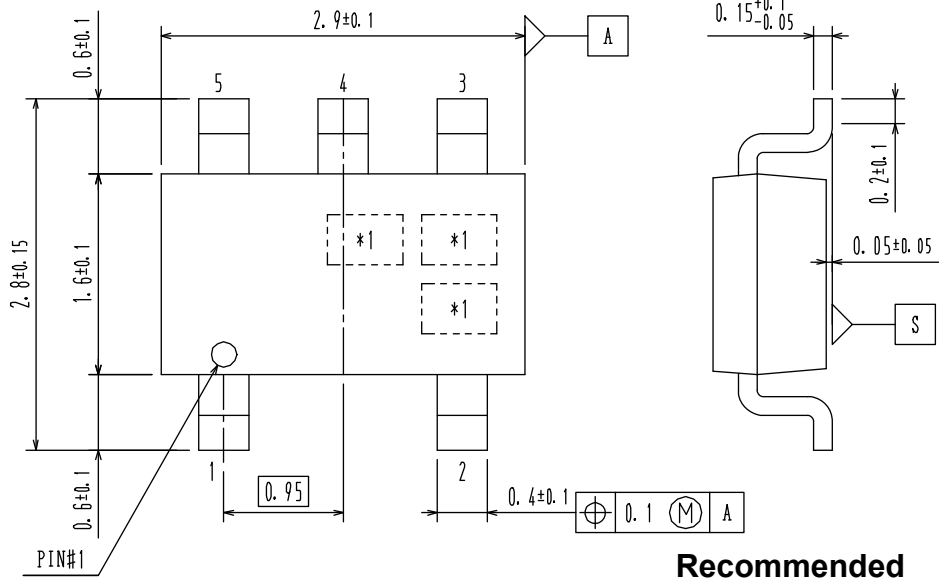

Recommended Soldering Footprint

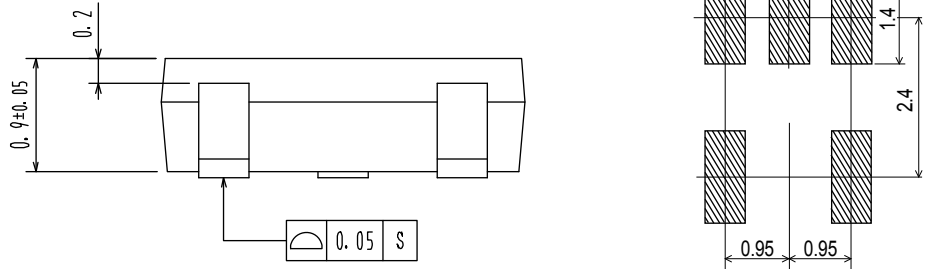

*1: Lot indication

ORDERING INFORMATION

Device	Package	Shipping	Note
CPH5871-TL-H	CPH5 SC-74A, SOT-25	3,000 pcs. / Tape & Reel	Pb-Free and Halogen Free
CPH5871-TL-W			

† For information on tape and reel specifications, including part orientation and tape sizes, please refer to our Tape and Reel Packaging Specifications Brochure, BRD8011/D. http://www.onsemi.com/pub_link/Collateral/BRD8011-D.PDF

Note on usage : Since the CPH5871 is a MOSFET product, please avoid using this device in the vicinity of highly charged objects.

ON Semiconductor and the ON logo are registered trademarks of Semiconductor Components Industries, LLC (SCILLC) or its subsidiaries in the United States and/or other countries. SCILLC owns the rights to a number of patents, trademarks, copyrights, trade secrets, and other intellectual property. A listing of SCILLC's product/patent coverage may be accessed at www.onsemi.com/site/pdf/Patent-Marking.pdf. SCILLC reserves the right to make changes without further notice to any products herein. SCILLC makes no warranty, representation or guarantee regarding the suitability of its products for any particular purpose, nor does SCILLC assume any liability arising out of the application or use of any product or circuit, and specifically disclaims any and all liability, including without limitation special, consequential or incidental damages. "Typical" parameters which may be provided in SCILLC data sheets and/or specifications can and do vary in different applications and actual performance may vary over time. All operating parameters, including "Typicals" must be validated for each customer application by customer's technical experts. SCILLC does not convey any license under its patent rights nor the rights of others. SCILLC products are not designed, intended, or authorized for use as components in systems intended for surgical implant into the body, or other applications intended to support or sustain life, or for any other application in which the failure of the SCILLC product could create a situation where personal injury or death may occur. Should Buyer purchase or use SCILLC products for any such unintended or unauthorized application, Buyer shall indemnify and hold SCILLC and its officers, employees, subsidiaries, affiliates, and distributors harmless against all claims, costs, damages, and expenses, and reasonable attorney fees arising out of, directly or indirectly, any claim of personal injury or death associated with such unintended or unauthorized use, even if such claim alleges that SCILLC was negligent regarding the design or manufacture of the part. SCILLC is an Equal Opportunity/Affirmative Action Employer. This literature is subject to all applicable copyright laws and is not for resale in any manner.