



CPH5901

N-Channel JFET and NPN Bipolar Transistor 15V, 6 to 20mA, 50V, 150mA, Composite type CPH5

ON Semiconductor®

<http://onsemi.com>

Features

- Composite type with J-FET and NPN transistors contained in the CPH5 package, improving the mounting efficiency greatly
- The CPH5901 is formed with two chips, being equivalent to the 2SK932 and the other the 2SC4639, placed in one package
- Common drain and emitter

Specifications

Absolute Maximum Ratings at Ta=25°C

Parameter	Symbol	Conditions	Ratings	Unit
[FET]				
Drain-to-Source Voltage	V _{DSX}		15	V
Gate-to-Drain Voltage	V _{GD}		-15	V
Gate Current	I _G		10	mA
Drain Current	I _D		50	mA
Allowable Power Dissipation	P _D	Mounted on a ceramic board (600mm ² ×0.8mm)	350	mW
[TR]				
Collector-to-Base Voltage	V _{CB}		55	V
Collector-to-Emitter Voltage	V _{CE}		50	V
Emitter-to-Base Voltage	V _{EB}		6	V
Collector Current	I _C		150	mA
Collector Current (Pulse)	I _{CP}		300	mA
Base Current	I _B		30	mA
Collector Dissipation	P _C	Mounted on a ceramic board (600mm ² ×0.8mm)	350	mW
[TR]				
Total Power Dissipation	P _T	Mounted on a ceramic board (600mm ² ×0.8mm)	500	mW
Junction Temperature	T _J		150	°C
Storage Temperature	T _{stg}		-55 to +150	°C

Stresses exceeding Maximum Ratings may damage the device. Maximum Ratings are stress ratings only. Functional operation above the Recommended Operating Conditions is not implied. Extended exposure to stresses above the Recommended Operating Conditions may affect device reliability.

Package Dimensions

unit : mm (typ)

7017A-007

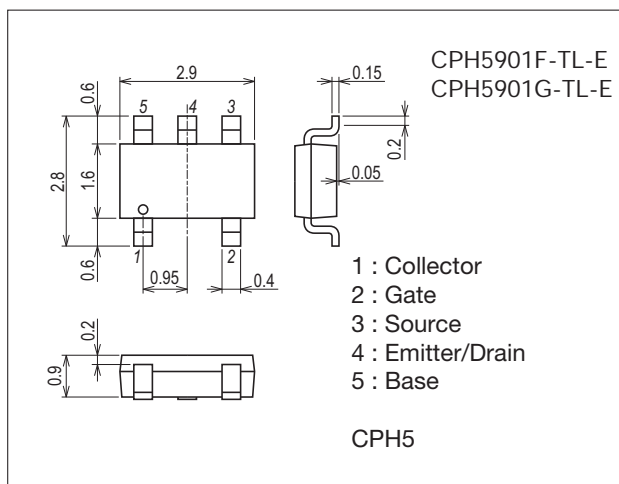

Product & Package Information

- Package : CPH5
- JEITA, JEDEC : SC-74A, SOT-25
- Minimum Packing Quantity : 3,000 pcs./reel

Packing Type : TL

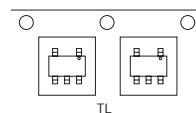

Marking

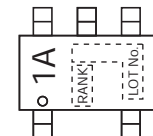

Electrical Connection

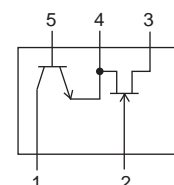

CPH5901

Electrical Characteristics at Ta=25°C

Parameter	Symbol	Conditions	Ratings			Unit
			min	typ	max	
[FET]						
Gate-to-Drain Breakdown Voltage	$V_{(BR)GDS}$	$I_G = -10\mu A, V_{GS} = 0V$	-15			V
Gate Cutoff Current	I_{GSS}	$V_{GS} = -10V, V_{DS} = 0V$			-1.0	nA
Cutoff Voltage	$V_{GS(off)}$	$V_{DS} = 5V, I_D = 100\mu A$	-0.2	-0.6	-1.4	V
Drain Current	I_{DSS}	$V_{DS} = 5V, V_{GS} = 0V$	6.0*		20.0*	mA
Forward Transfer Admittance	$ y_{fs} $	$V_{DS} = 5V, V_{GS} = 0V, f = 1kHz$	25	50		mS
Input Capacitance	C_{iss}	$V_{DS} = 5V, V_{GS} = 0V, f = 1kHz$		10		pF
Reverse Transfer Capacitance	C_{rss}	$V_{DS} = 5V, V_{GS} = 0V, f = 1kHz$		3.0		pF
Noise Figure	NF	$V_{DS} = 5V, R_g = 1k\Omega, I_D = 1mA, f = 1kHz$		1.5		dB
[TR]						
Collector Cutoff Current	I_{CBO}	$V_{CB} = 35V, I_E = 0A$			0.1	μA
Emitter Cutoff Current	I_{EBO}	$V_{EB} = 4V, I_C = 0A$			0.1	μA
DC Current Gain	h_{FE}	$V_{CE} = 6V, I_C = 1mA$	135		400	
Gain-Bandwidth Product	f_T	$V_{CE} = 6V, I_C = 10mA$		200		MHz
Output Capacitance	C_{ob}	$V_{CB} = 6V, f = 1MHz$		1.7		pF
Collector-to-Emitter Saturation Voltage	$V_{CE(sat)}$	$I_C = 50mA, I_B = 5mA$		0.08	0.4	mV
Base-to-Emitter Saturation Voltage	$V_{BE(sat)}$	$I_C = 50mA, I_B = 5mA$		0.8	1.0	V
Collector-to-Base Breakdown Voltage	$V_{(BR)CBO}$	$I_C = 10\mu A, I_E = 0A$	55			V
Collector-to-Emitter Breakdown Voltage	$V_{(BR)CEO}$	$I_C = 1mA, R_{BE} = \infty$	50			V
Emitter-to-Base Breakdown Voltage	$V_{(BR)EBO}$	$I_E = 10\mu A, I_C = 0A$	6			V
Turn-On Time	t_{on}	See specified Test Circuit.		0.15		ns
Storage Time	t_{stg}			0.75		ns
Fall Time	t_f			0.20		ns

* : The CPH5901 is classified by I_{DSS} as follows : (unit : mA)

Rank	F	G
I_{DSS}	6.0 to 12.0	10.0 to 20.0

Switching Time Test Circuit

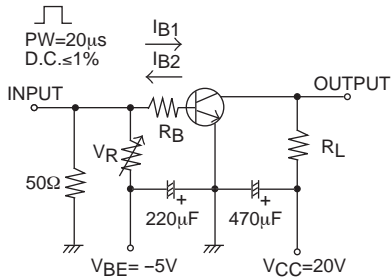

$$10I_{B1} = -10I_{B2} = I_C = 10mA$$

Ordering Information

Device	Package	Shipping	memo
CPH5901F-TL-E	CPH5	3,000pcs./reel	Pb Free
CPH5901G-TL-E	CPH5	3,000pcs./reel	

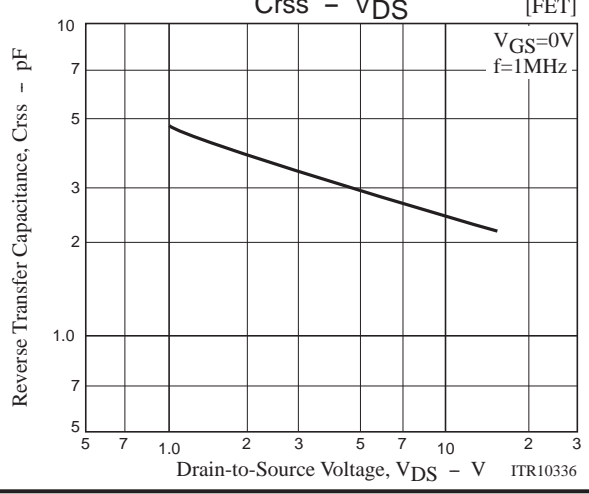
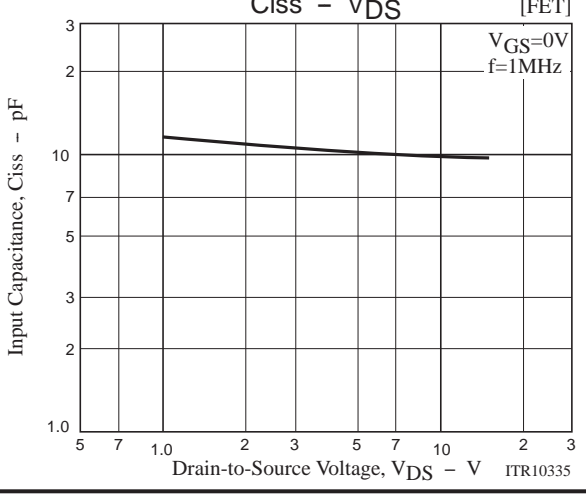
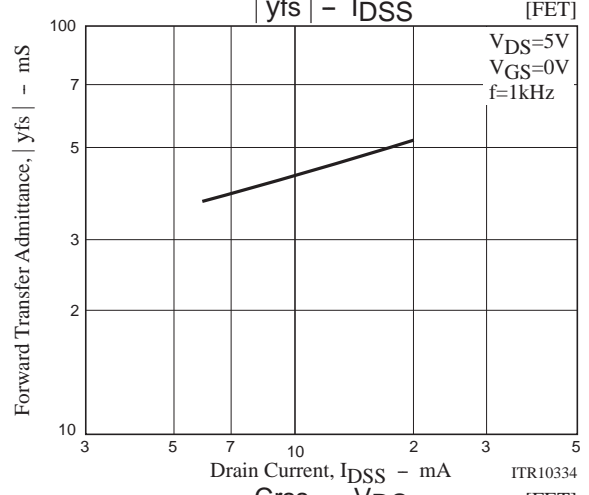
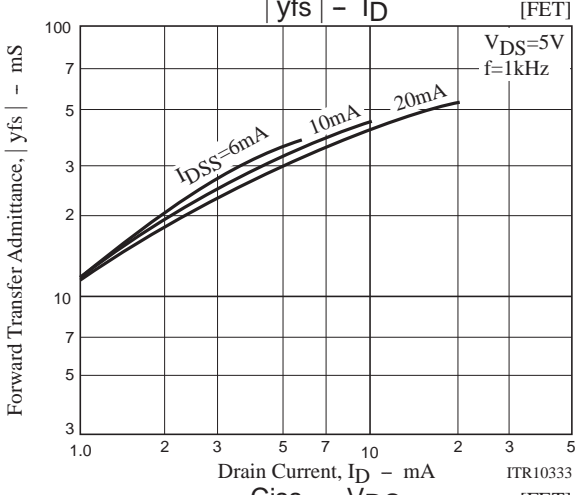
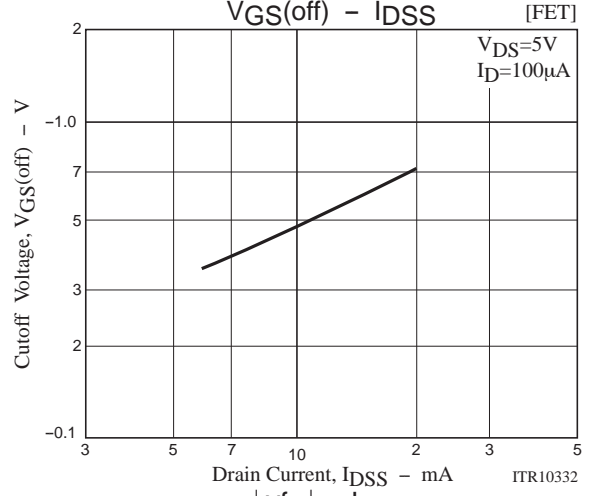
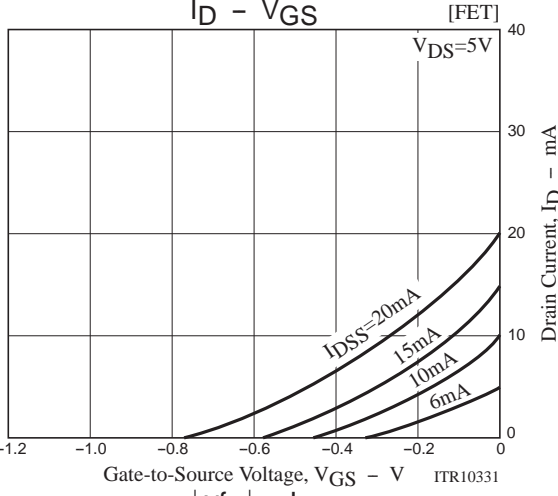
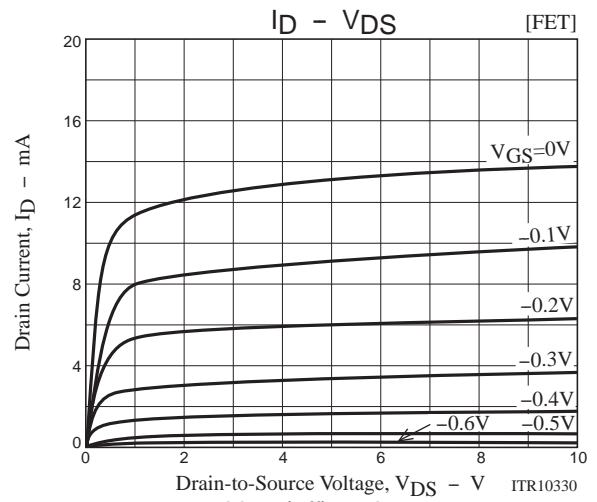
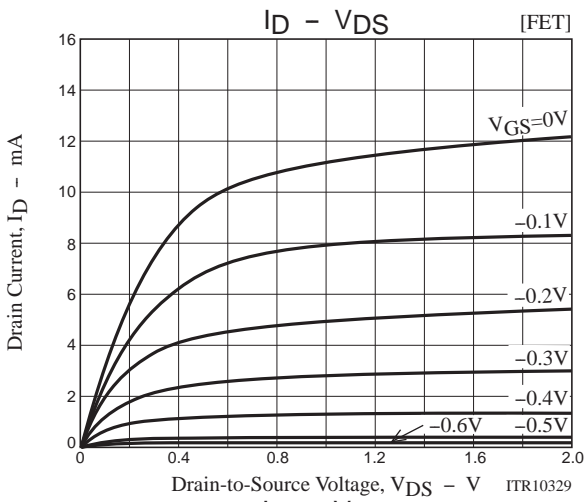

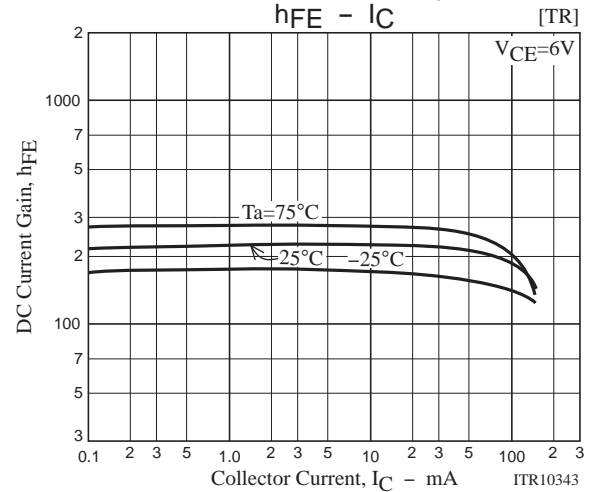
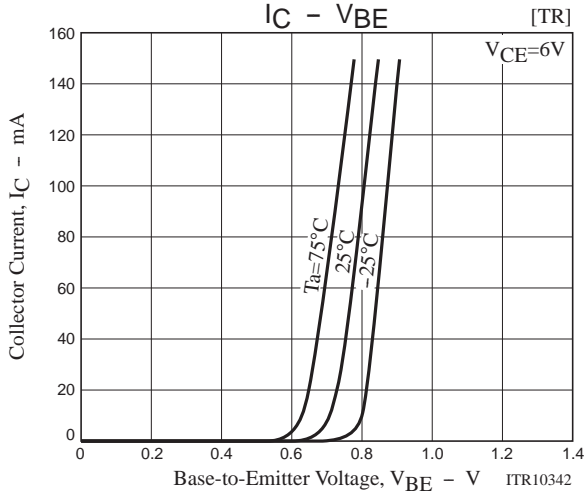
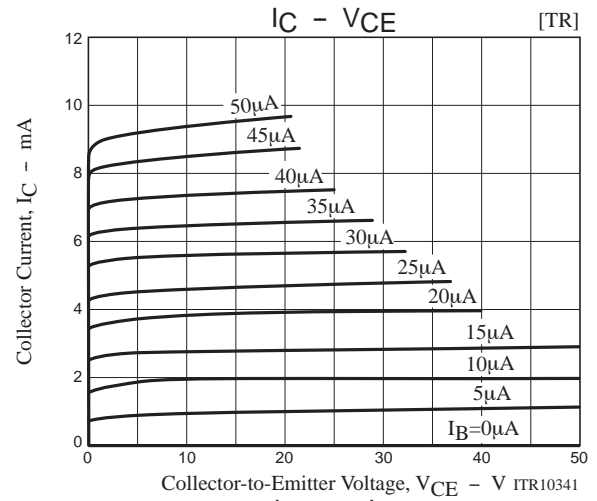
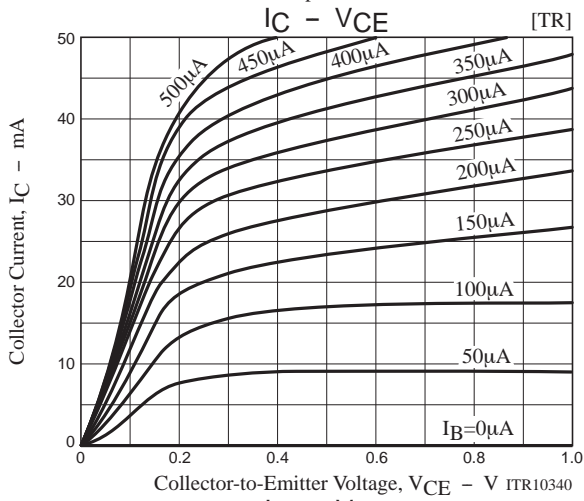
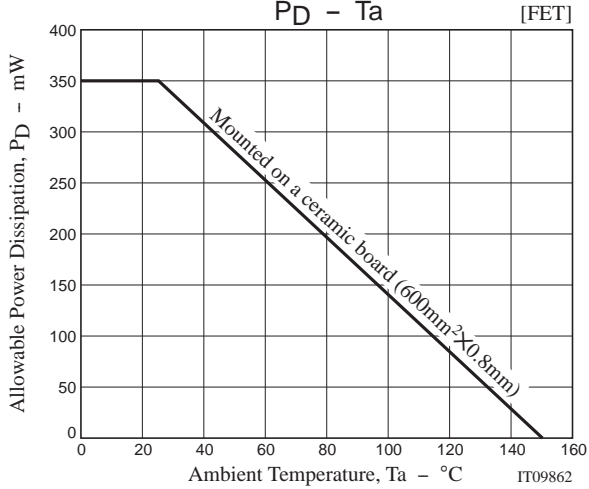
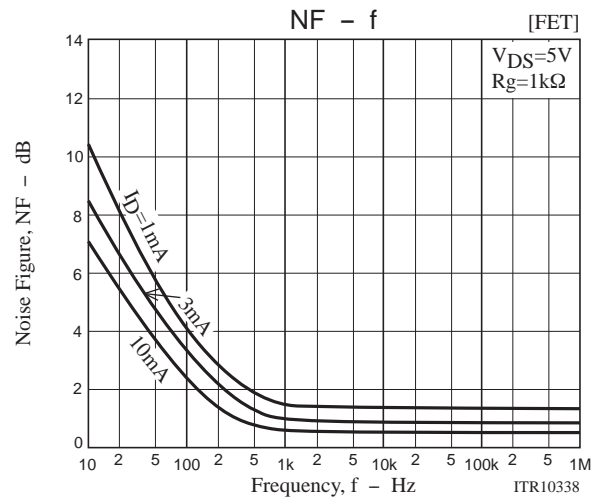
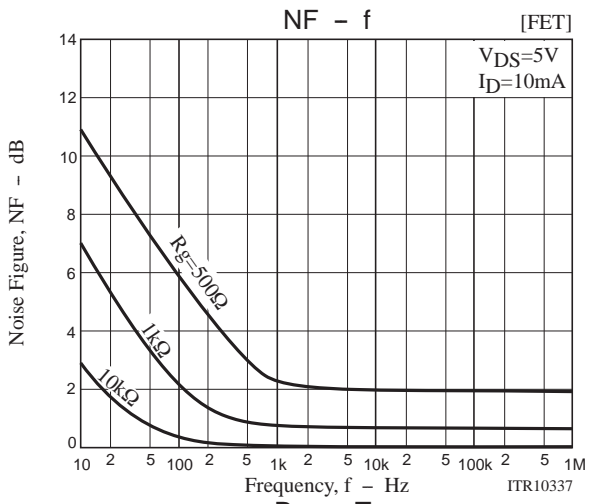

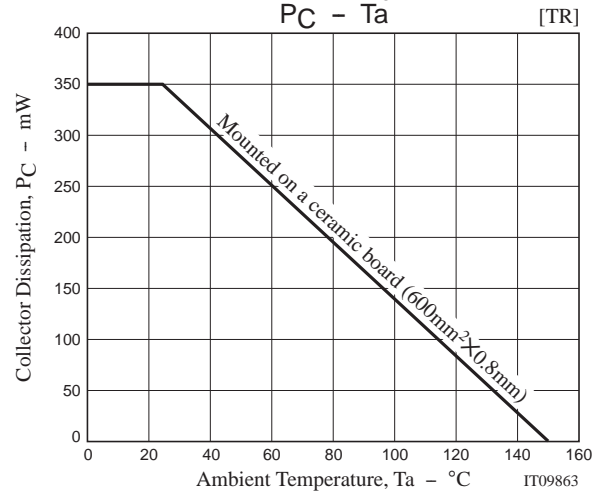
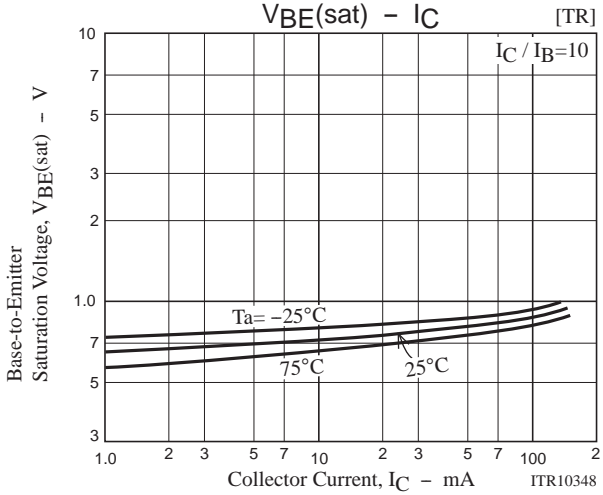
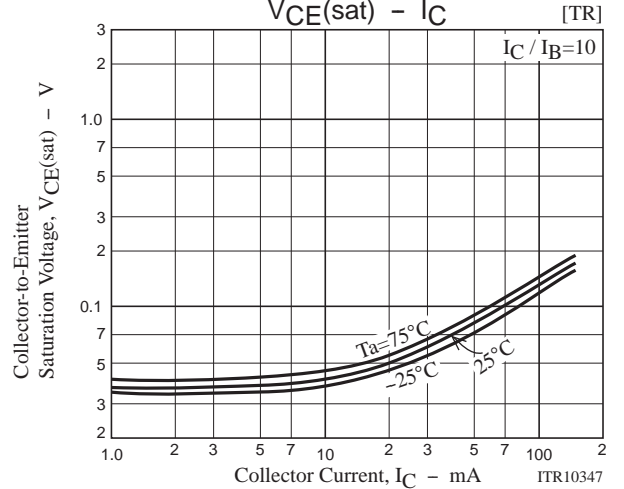
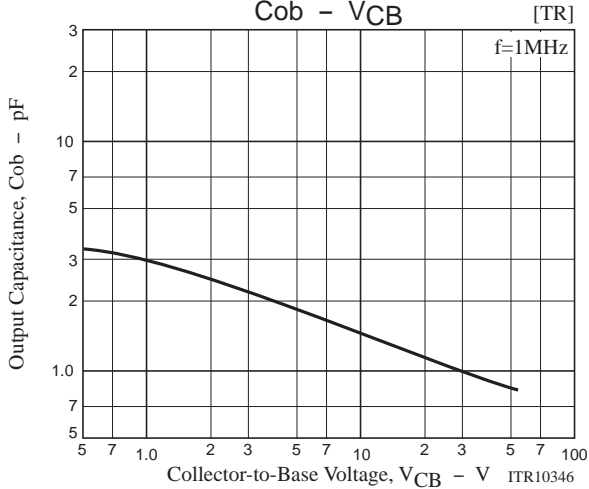
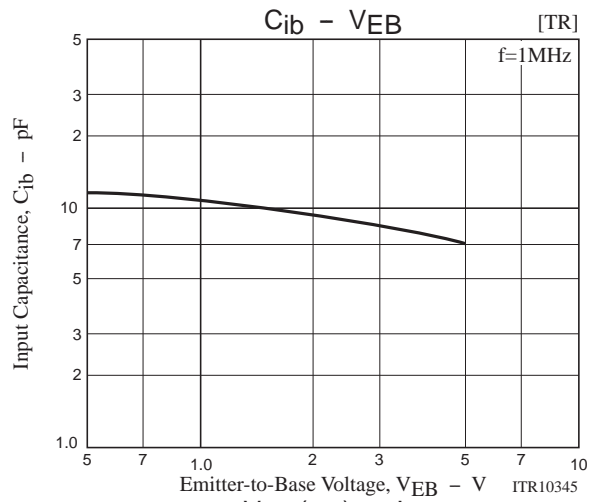
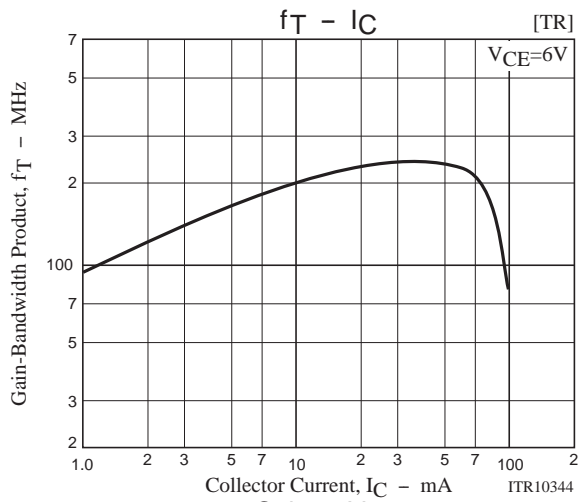

Embossed Taping Specification

CPH5901F-TL-E, CPH5901G-TL-E

1. Packing Format

Package Name	Carrier Tape Type	Maximum Number of devices contained (pcs)			Packing format	
		Reel	Inner box	Outer box	Inner BOX (C-1)	Outer BOX (A-7)
CPH5	CPH6	3,000	15,000	90,000	5 reels contained Dimensions:mm (external) 183×72×185	6 inner boxes contained Dimensions:mm (external) 440×195×210

Reel label, Inner box label
(unit:mm)

Outer box label
It is a label at the time of factory shipments.
The form of a label may change in physical distribution process.

Packing method

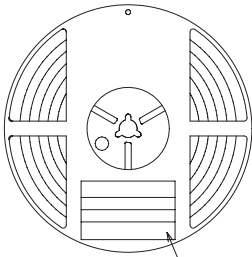

Reel label

Type No.
LOT No.
Quantity
Origin

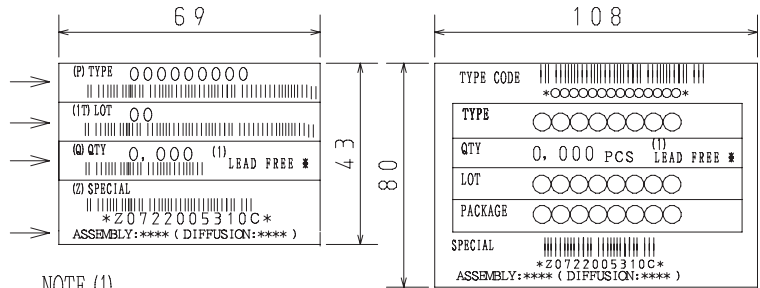

NOTE (1)

The LEAD FREE * description shows that the surface treatment of the terminal is lead free.

Label	JEITA Phase
LEAD FREE 3	JEITA Phase 3A
LEAD FREE 4	JEITA Phase 3

2. Taping configuration

2-1. Carrier tape size (unit:mm)

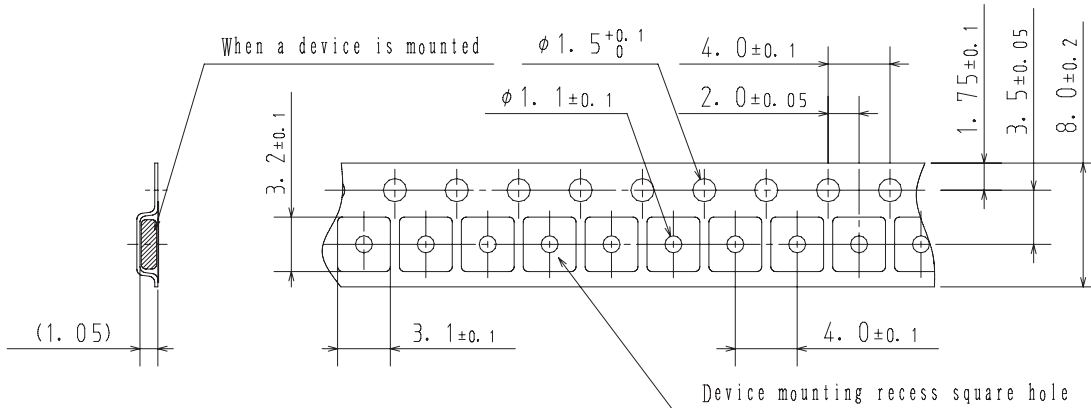

2-2. Device placement direction

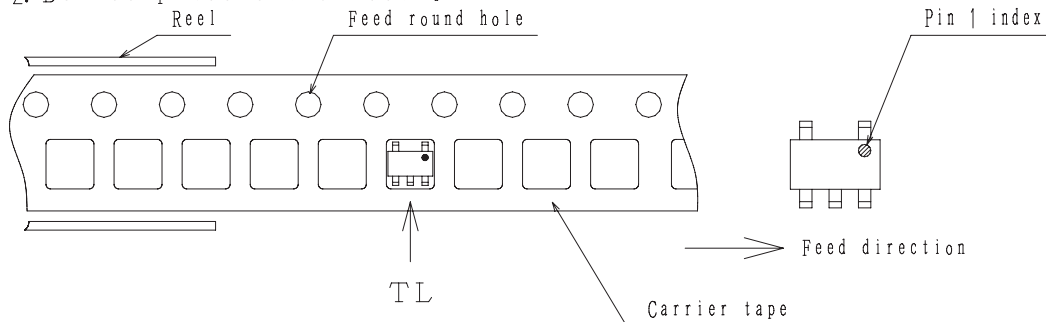

Those with pin 1 index on the feed hole side.....TL

CPH5901

Outline Drawing

CPH5901F-TL-E, CPH5901G-TL-E

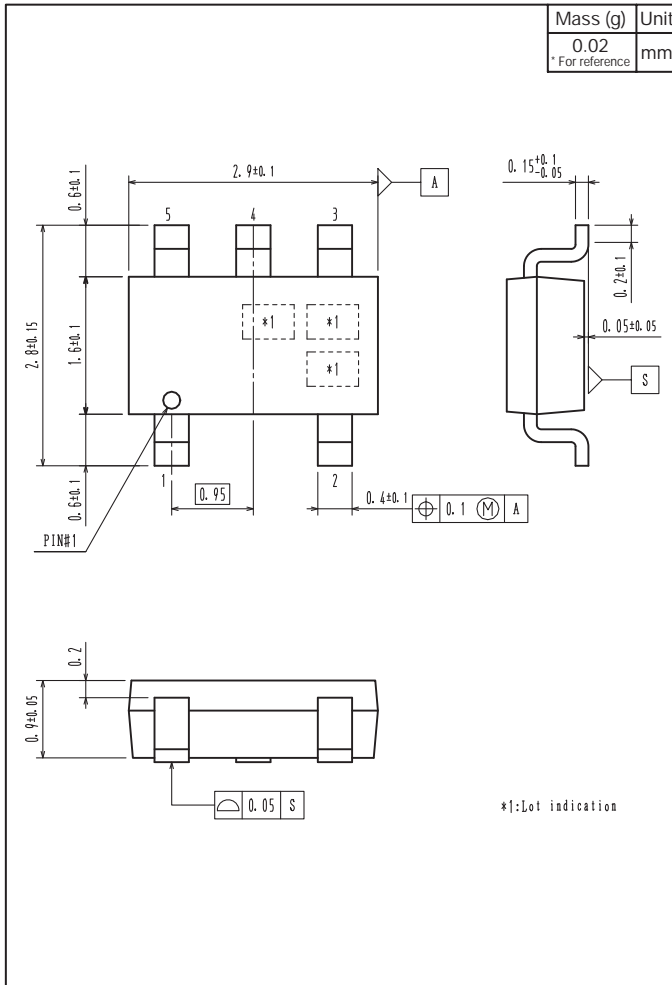

Land Pattern Example

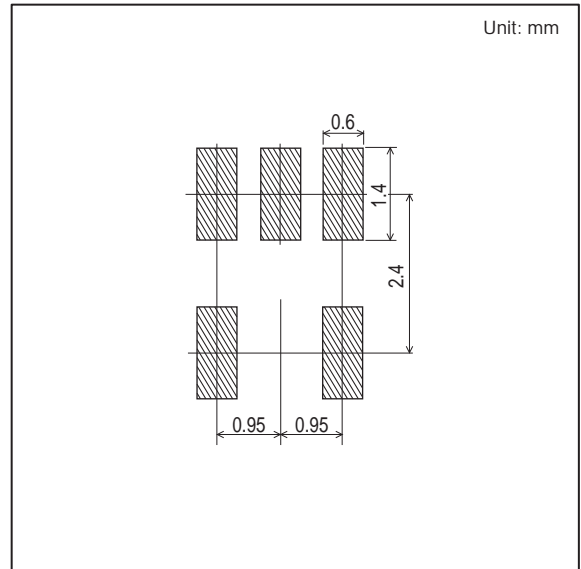

ON Semiconductor and the ON logo are registered trademarks of Semiconductor Components Industries, LLC (SCILLC). SCILLC owns the rights to a number of patents, trademarks, copyrights, trade secrets, and other intellectual property. A listing of SCILLC's product/patent coverage may be accessed at www.onsemi.com/site/pdf/Patent-Marking.pdf. SCILLC reserves the right to make changes without further notice to any products herein. SCILLC makes no warranty, representation or guarantee regarding the suitability of its products for any particular purpose, nor does SCILLC assume any liability arising out of the application or use of any product or circuit, and specifically disclaims any and all liability, including without limitation special, consequential or incidental damages. "Typical" parameters which may be provided in SCILLC data sheets and/or specifications can and do vary in different applications and actual performance may vary over time. All operating parameters, including "Typicals" must be validated for each customer application by customer's technical experts. SCILLC does not convey any license under its patent rights nor the rights of others. SCILLC products are not designed, intended, or authorized for use as components in systems intended for surgical implant into the body, or other applications intended to support or sustain life, or for any other application in which the failure of the SCILLC product could create a situation where personal injury or death may occur. Should Buyer purchase or use SCILLC products for any such unintended or unauthorized application, Buyer shall indemnify and hold SCILLC and its officers, employees, subsidiaries, affiliates, and distributors harmless against all claims, costs, damages, and expenses, and reasonable attorney fees arising out of, directly or indirectly, any claim of personal injury or death associated with such unintended or unauthorized use, even if such claim alleges that SCILLC was negligent regarding the design or manufacture of the part. SCILLC is an Equal Opportunity/Affirmative Action Employer. This literature is subject to all applicable copyright laws and is not for resale in any manner.