



SANYO Semiconductors

DATA SHEET

CPH5905 — High-Frequency Amplifier. AM Amplifier. Low-Frequency Amplifier Applications

NPN Epitaxial Planar Silicon Transistor
N-Channel Silicon Junction FET

Features

- Composite type with J-FET and NPN transistors contained in the CPH5 package, improving the mounting efficiency greatly.
- The CPH5905 contains a 2SK3557-equivalent chip and a 2SC4639-equivalent chip in one package.
- Drain and emitter are shared.

Specifications

Absolute Maximum Ratings at Ta=25°C

Parameter	Symbol	Conditions	Ratings	Unit
[FET]				
Drain-to-Source Voltage	V _{DSX}		15	V
Gate-to-Drain Voltage	V _{GD}		-15	V
Gate Current	I _G		10	mA
Drain Current	I _D		50	mA
Allowable Power Dissipation	P _D	Mounted on a ceramic board (600mm ² X0.8mm)	350	mW
[TR]				
Collector-to-Base Voltage	V _{CB}		55	V
Collector-to-Emitter Voltage	V _{CE}		50	V
Emitter-to-Base Voltage	V _{EB}		6	V
Collector Current	I _C		150	mA
Collector Current (Pulse)	I _{CP}		300	mA
Base Current	I _B		30	mA
Collector Dissipation	P _C	Mounted on a ceramic board (600mm ² X0.8mm)	350	mW
[Common Ratings]				
Total Dissipation	P _T	Mounted on a ceramic board (600mm ² X0.8mm)	500	mW
Junction Temperature	T _J		150	°C
Storage Temperature	T _{stg}		-55 to +150	°C

Marking : 1E

■ Any and all SANYO products described or contained herein do not have specifications that can handle applications that require extremely high levels of reliability, such as life-support systems, aircraft's control systems, or other applications whose failure can be reasonably expected to result in serious physical and/or material damage. Consult with your SANYO representative nearest you before using any SANYO products described or contained herein in such applications.

■ SANYO assumes no responsibility for equipment failures that result from using products at values that exceed, even momentarily, rated values (such as maximum ratings, operating condition ranges, or other parameters) listed in products specifications of any and all SANYO products described or contained herein.

SANYO Electric Co., Ltd. Semiconductor Company

TOKYO OFFICE Tokyo Bldg., 1-10, 1 Chome, Ueno, Taito-ku, TOKYO, 110-8534 JAPAN

CPH5905

Electrical Characteristics at Ta=25°C

Parameter	Symbol	Conditions	Ratings			Unit
			min	typ	max	
[FET]						
Gate-to-Drain Breakdown Voltage	$V_{(BR)GDS}$	$I_G=-10\mu A, V_{DS}=0V$	-15			V
Gate Cutoff Current	I_{GSS}	$V_{GS}=-10V, V_{DS}=0V$			-1.0	nA
Cutoff Voltage	$V_{GS(off)}$	$V_{DS}=5V, I_D=100\mu A$	-0.4	-0.7	-1.5	V
Drain Current	I_{DSS}	$V_{DS}=5V, V_{GS}=0V$	10.0*		32.0*	mA
Forward Transfer Admittance	$ y_{fs} $	$V_{DS}=5V, V_{GS}=0V, f=1kHz$	24	35		mS
Input Capacitance	C_{iss}	$V_{DS}=5V, V_{GS}=0V, f=1MHz$		10.0		pF
Reverse Transfer Capacitance	C_{rss}	$V_{DS}=5V, V_{GS}=0V, f=1MHz$		2.9		pF
Noise Figure	NF	$V_{DS}=5V, R_g=1k\Omega, I_D=1mA, f=1kHz$		1.0		dB
[TR]						
Collector Cutoff Current	I_{CBO}	$V_{CB}=35V, I_E=0A$			0.1	μA
Emitter Cutoff Current	I_{EBO}	$V_{EB}=4V, I_C=0A$			0.1	μA
DC Current Gain	h_{FE}	$V_{CE}=6V, I_C=1mA$	135		400	
Gain-Bandwidth Product	f_T	$V_{CE}=6V, I_C=10mA$		200		MHz
Output Capacitance	C_{ob}	$V_{CB}=6V, f=1MHz$		1.7		pF
Collector-to-Emitter Saturation Voltage	$V_{CE(sat)}$	$I_C=50mA, I_B=5mA$		0.08	0.4	V
Base-to-Emitter Saturation Voltage	$V_{BE(sat)}$	$I_C=50mA, I_B=5mA$		0.8	1.0	V
Collector-to-Base Breakdown Voltage	$V_{(BR)CBO}$	$I_C=10\mu A, I_E=0A$	55			V
Collector-to-Emitter Breakdown Voltage	$V_{(BR)CEO}$	$I_C=1mA, R_{BE}=\infty$	50			V
Emitter-to-Base Breakdown Voltage	$V_{(BR)EBO}$	$I_E=10\mu A, I_C=0A$	6			V
Turn-ON Time	t_{on}	See specified Test Circuit.		0.15		μs
Storage Time	t_{stg}	See specified Test Circuit.		0.75		μs
Fall Time	t_f	See specified Test Circuit.		0.20		μs

* : The CPH5905 is classified by I_{DSS} as follows : (unit : mA)

Rank	G	H
I_{DSS}	10.0 to 20.0	16.0 to 32.0

The specifications shown above are for each individual FET or a transistor.

Package Dimensions

unit : mm

7017-007

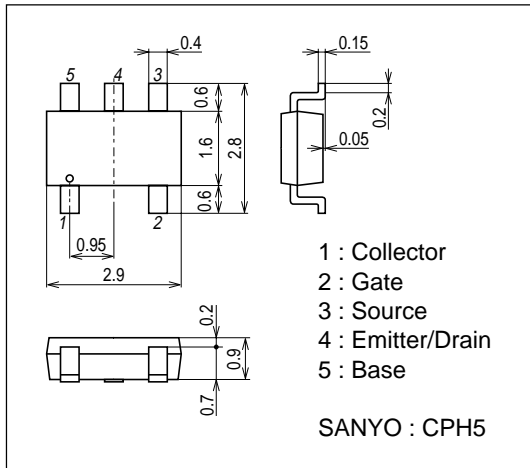

Electrical Connection

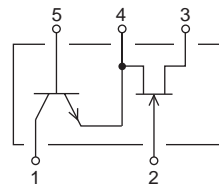

- 1 : Collector
- 2 : Gate
- 3 : Source
- 4 : Emitter/Drain
- 5 : Base

Top view

Switching Time Test Circuit

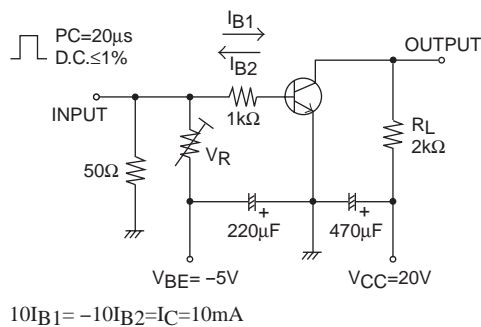

CPH5905

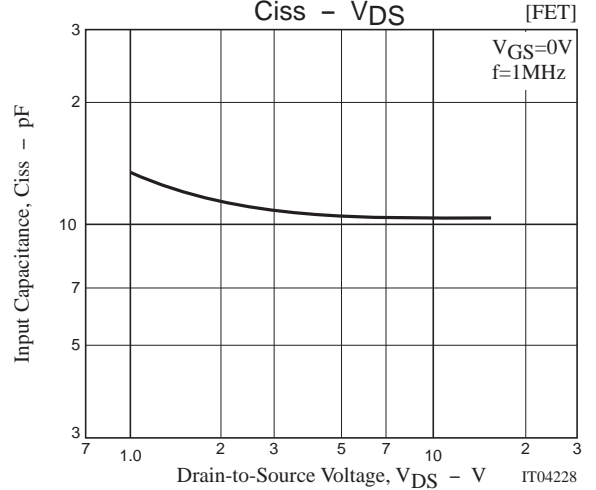
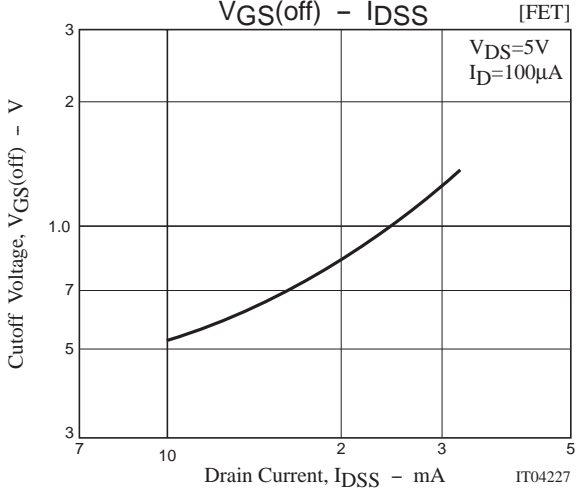
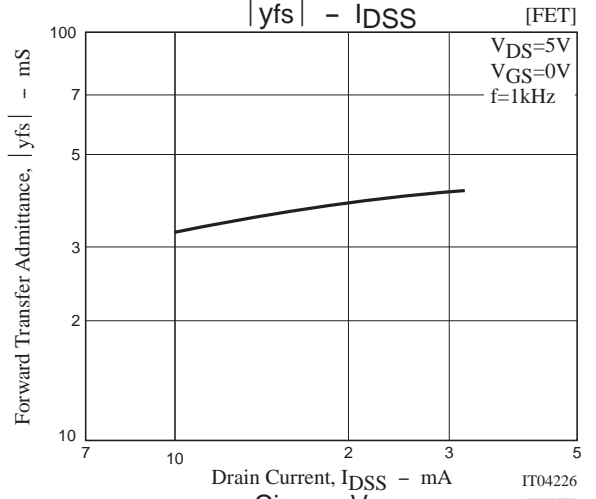
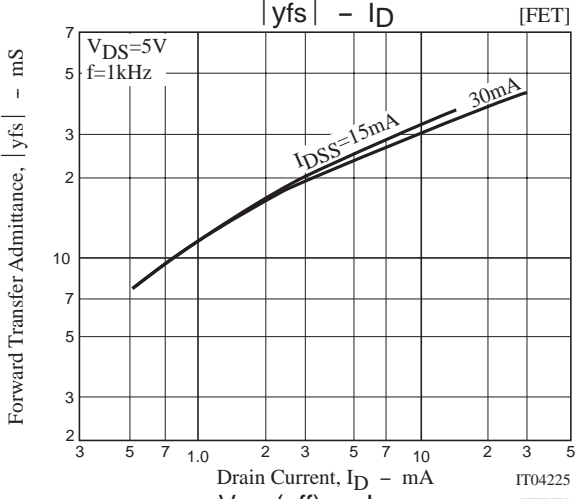
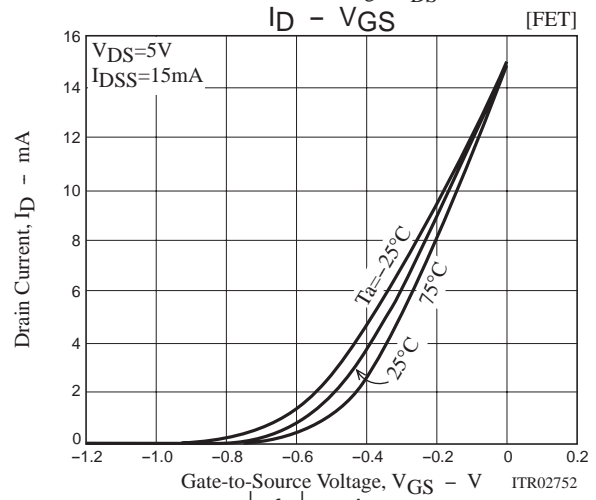
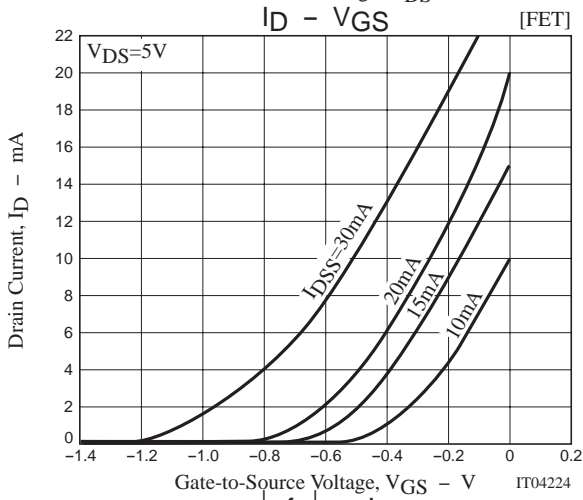
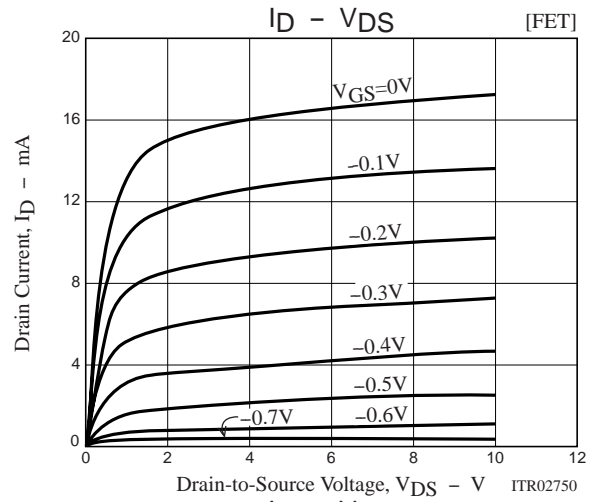
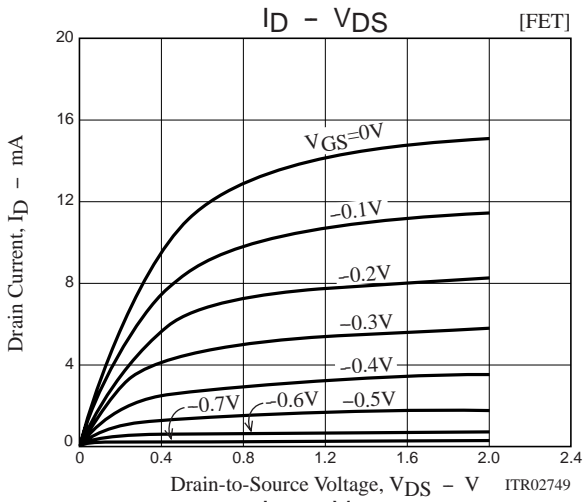

CPH5905

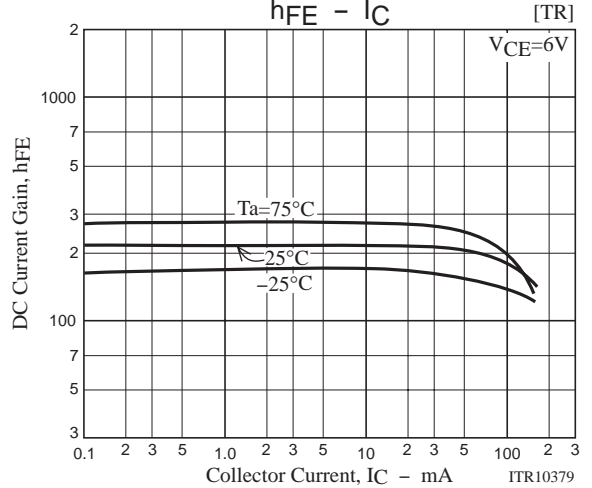
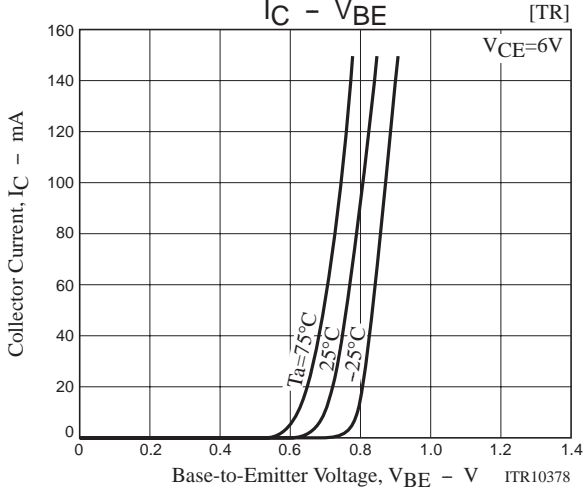
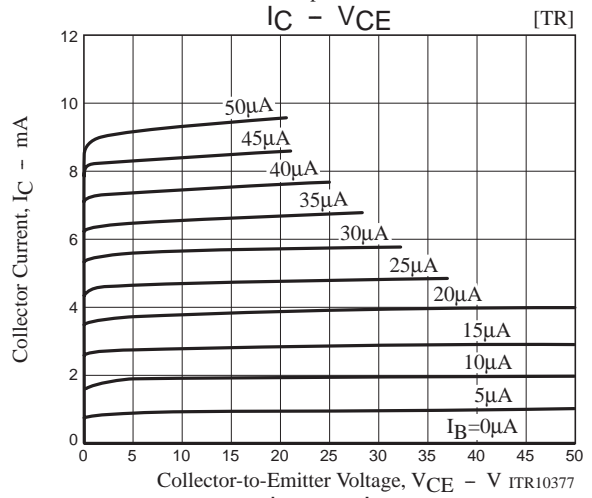
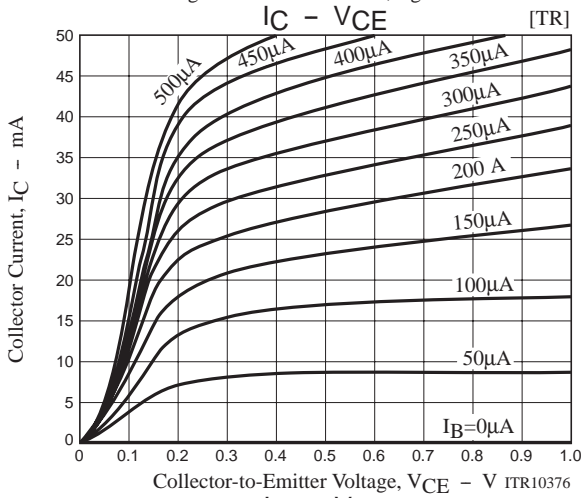
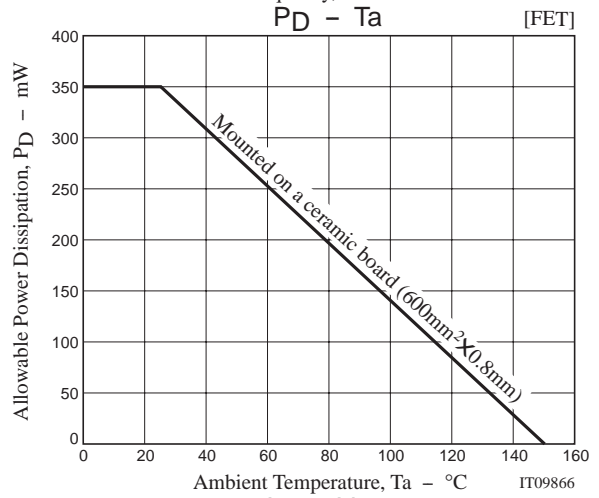
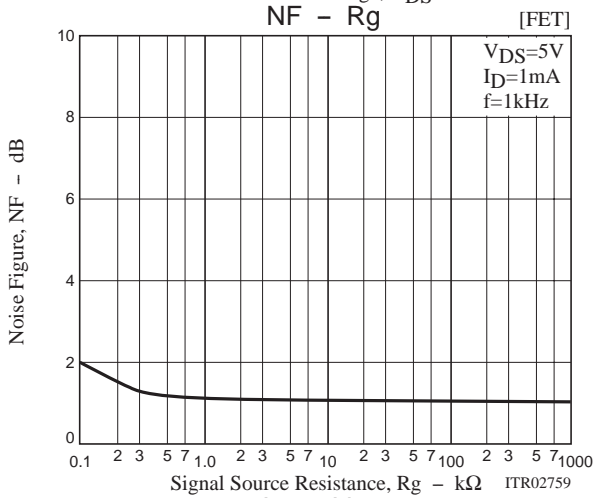
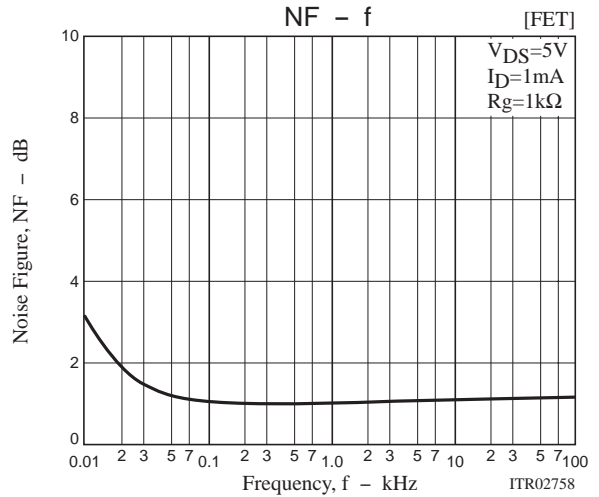
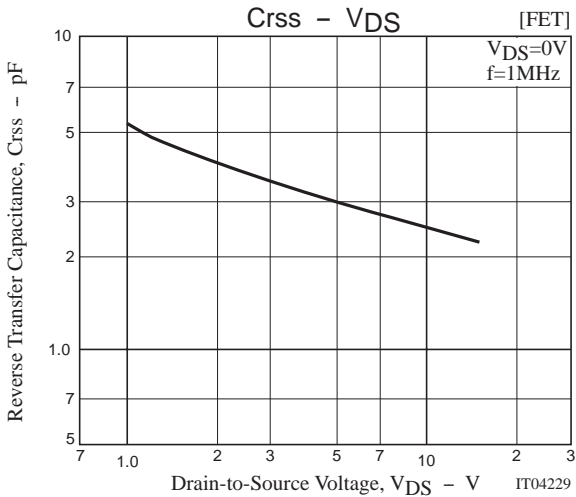

CPH5905

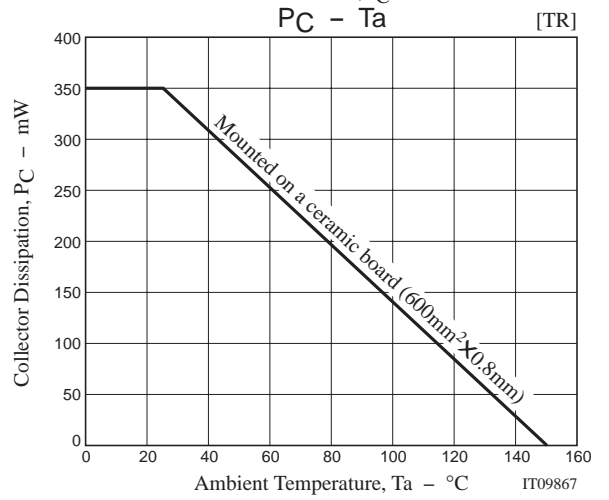
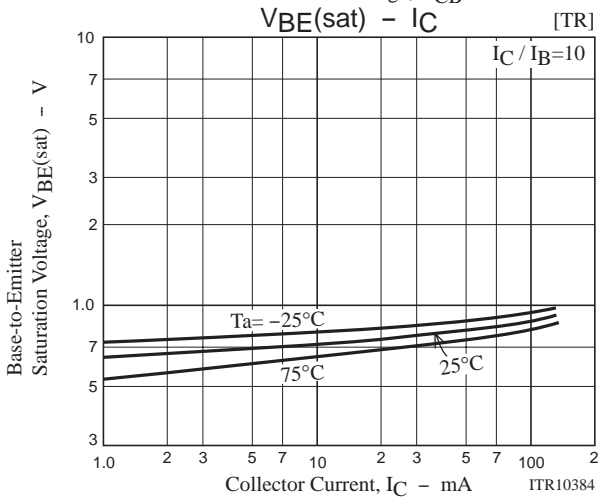
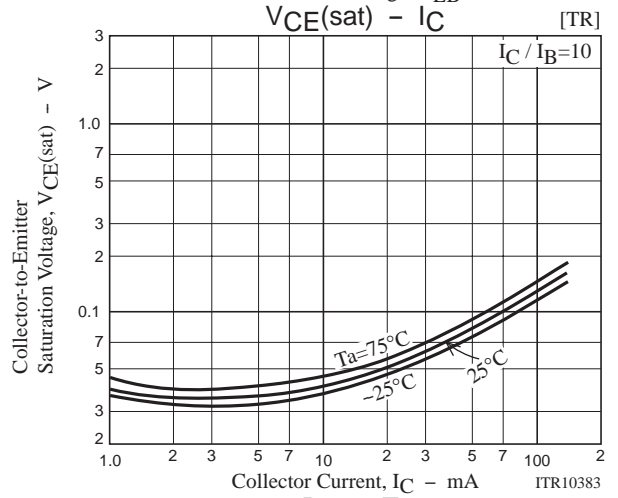
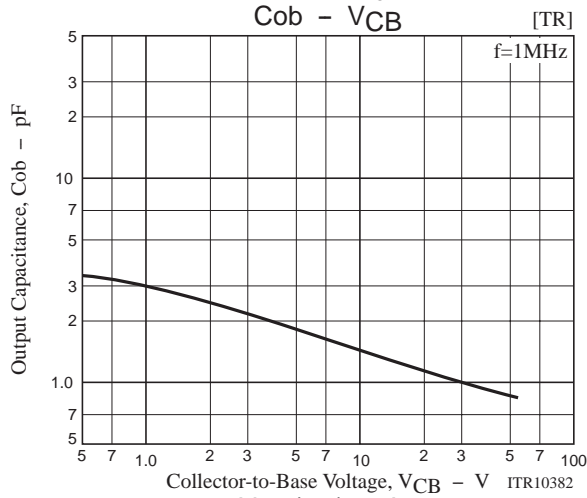
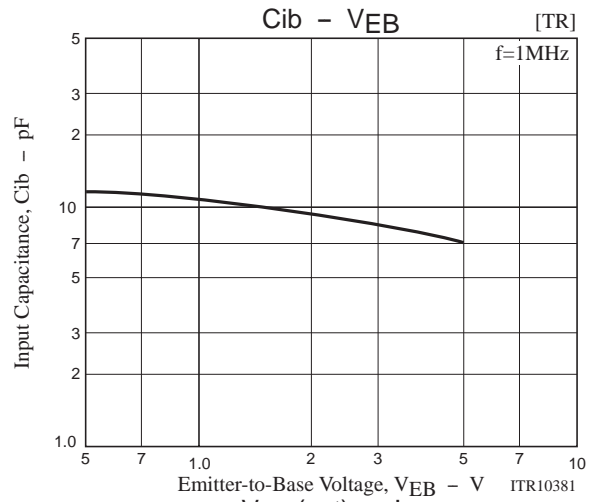
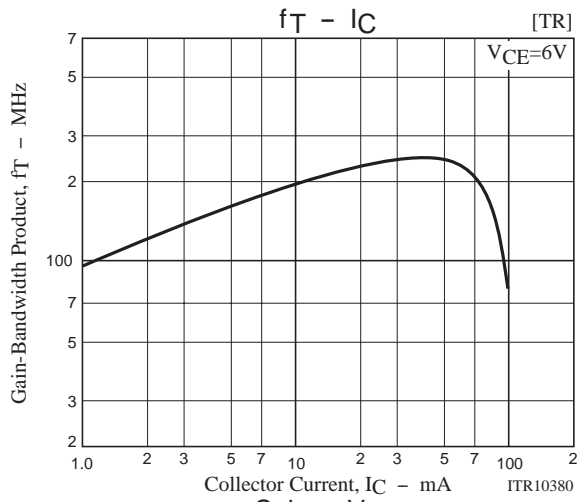

- Specifications of any and all SANYO products described or contained herein stipulate the performance, characteristics, and functions of the described products in the independent state, and are not guarantees of the performance, characteristics, and functions of the described products as mounted in the customer's products or equipment. To verify symptoms and states that cannot be evaluated in an independent device, the customer should always evaluate and test devices mounted in the customer's products or equipment.
- SANYO Electric Co., Ltd. strives to supply high-quality high-reliability products. However, any and all semiconductor products fail with some probability. It is possible that these probabilistic failures could give rise to accidents or events that could endanger human lives, that could give rise to smoke or fire, or that could cause damage to other property. When designing equipment, adopt safety measures so that these kinds of accidents or events cannot occur. Such measures include but are not limited to protective circuits and error prevention circuits for safe design, redundant design, and structural design.
- In the event that any or all SANYO products(including technical data, services) described or contained herein are controlled under any of applicable local export control laws and regulations, such products must not be exported without obtaining the export license from the authorities concerned in accordance with the above law.
- No part of this publication may be reproduced or transmitted in any form or by any means, electronic or mechanical, including photocopying and recording, or any information storage or retrieval system, or otherwise, without the prior written permission of SANYO Electric Co., Ltd.
- Any and all information described or contained herein are subject to change without notice due to product/technology improvement, etc. When designing equipment, refer to the "Delivery Specification" for the SANYO product that you intend to use.
- Information (including circuit diagrams and circuit parameters) herein is for example only ; it is not guaranteed for volume production. SANYO believes information herein is accurate and reliable, but no guarantees are made or implied regarding its use or any infringements of intellectual property rights or other rights of third parties.

This catalog provides information as of June, 2005. Specifications and information herein are subject to change without notice.