

External Drive Piezo Transducer (AC)

CANOPUS

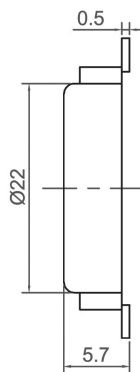

CPT2206

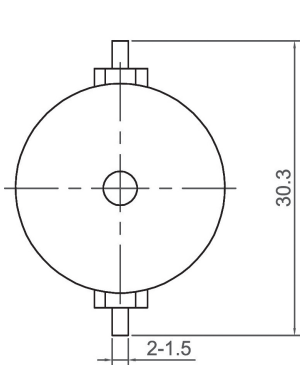
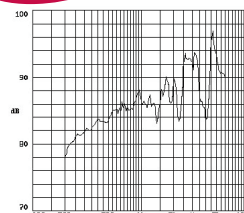

Canopus Part no.	Min sound Output (dBA)	Rated Voltage (V)	Max Input Voltage (V)	Resonant Frequency (Hz)	Capacitance (pF)	Operating Temperature (°C)	Housing	Weight (g)
CPT2206H25LP	80 AT 10cm	10 Vp-p	30 Vrms	2500	25000 ± 30% at 1000Hz	-30 ~ +85	LCP	2



CPT2207

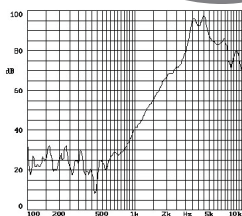
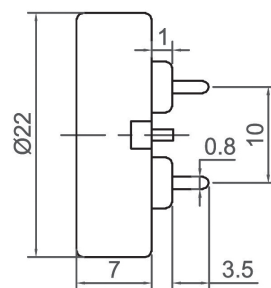
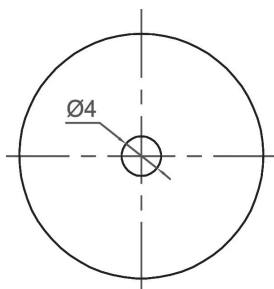

Canopus Part no.	Min sound Output (dBA)	Rated Voltage (V)	Max Input Voltage (V)	Resonant Frequency (Hz)	Capacitance (pF)	Operating Temperature (°C)	Housing	Weight (g)
CPT2207C40TP	80 AT 10cm	3 Vp-p	30 Vrms	4000	15000 ± 30% at 1000Hz	-20 ~ +60	PBT	3

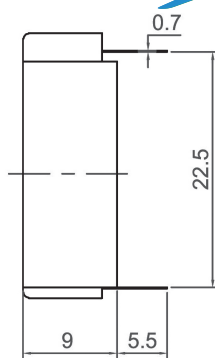
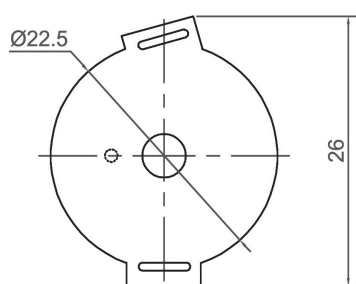

CPT2209

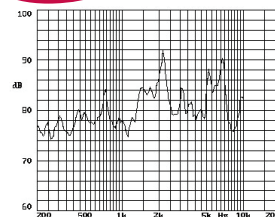

Canopus Part no.	Min sound Output (dBA)	Rated Voltage (V)	Max Input Voltage (V)	Resonant Frequency (Hz)	Capacitance (pF)	Operating Temperature (°C)	Housing	Weight (g)
CPT2209H20NP	80 AT 10cm	10 Vp-p	40 Vrms	2048	24000 ± 30% at 1000Hz	-20 ~ +80	Noryl	2

Your Efficient Supplier
www.canopus.com.hk

TEL.: (852) 2806 2812

Fax: (852) 2652 2216