

# BCR16A, BCR16B, BCR16C, BCR16E

MEDIUM POWER USE

A, B, C : NON-INSULATED TYPE, E : INSULATED TYPE, GLASS PASSIVATION TYPE

**BCR16A, BCR16B, BCR16C, BCR16E**



- **IT (RMS)** ..... **16A**
- **VDRM** ..... **400V/500V**
- **IFGT I , IRGT I , IRGT III** ..... **30mA**

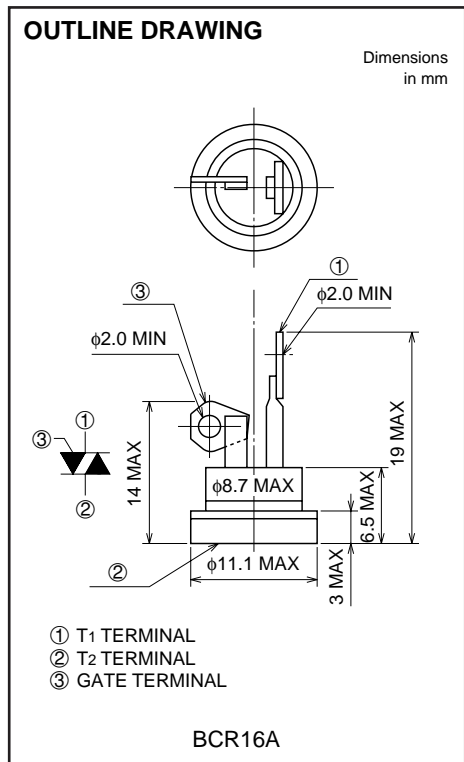

## APPLICATION

Contactless AC switches, light dimmer, on/off and speed control of small induction motors, on/off control of traffic signals, on/off control of copier lamps, solid state relay, microwave ovens

## MAXIMUM RATINGS

Symbol	Parameter	Voltage class		Unit
		8	10	
VDRM	Repetitive peak off-state voltage *1	400	500	V
VDSM	Non-repetitive peak off-state voltage *1	600	700	V

Symbol	Parameter	Conditions		Ratings	Unit
		BCR16A, B, C	BCR16E		
IT (RMS)	RMS on-state current	Commercial frequency, sine full wave, 360° conduction	Tc=99°C	16	A
			Tb=71°C		
ITSM	Surge on-state current	60Hz sinewave 1 full cycle, peak value, non-repetitive		170	A
i <sup>2</sup> <sub>t</sub>	i <sup>2</sup> <sub>t</sub> for fusing	Value corresponding to 1 cycle of half wave 60Hz, surge on-state current		121	A <sup>2</sup> s
PGM	Peak gate power dissipation			5	W
PG (AV)	Average gate power dissipation			0.5	W
VGM	Peak gate voltage			10	V
IGM	Peak gate current			2	A
Tj	Junction temperature			-20 ~ +125	°C

\*1. Gate open.

**BCR16A, BCR16B, BCR16C, BCR16E****MEDIUM POWER USE****A, B, C : NON-INSULATED TYPE, E : INSULATED TYPE, GLASS PASSIVATION TYPE****MAXIMUM RATINGS (continue)**

Symbol	Parameter	Test conditions	Ratings	Unit
T <sub>stg</sub>	Storage temperature		-20 ~ +125	°C
—	Weight (Typical value)	BCR16A	3.0	g
		BCR16B	8.5	
		BCR16C	8.5	
		BCR16E	9.5	
—	Soldering temperature	BCR16A only, 10 sec.	230	°C
—	Mounting torque	BCR16C only (Typical value)	30	kg-cm
			2.94	N-m
V <sub>iso</sub>	Isolated voltage	BCR16E only, T <sub>a</sub> =25°C, AC 1 minute, T <sub>2</sub> Terminal to base	1500	V

**ELECTRICAL CHARACTERISTICS**

Symbol	Parameter	Test conditions	Limits			Unit	
			Min.	Typ.	Max.		
I <sub>DRM</sub>	Repetitive peak off-state current	T <sub>j</sub> =125°C, V <sub>DRM</sub> applied	—	—	3.0	mA	
V <sub>TM</sub>	On-state voltage	T <sub>c</sub> =25°C, T <sub>b</sub> =25°C (BCR16E only), I <sub>TM</sub> =25A, Instantaneous measurement	—	—	1.6	V	
V <sub>FGT I</sub>	Gate trigger voltage *2	T <sub>j</sub> =25°C, V <sub>D</sub> =6V, R <sub>L</sub> =6Ω, R <sub>G</sub> =330Ω	I	—	—	1.5	V
V <sub>RGT I</sub>			II	—	—	1.5	V
V <sub>RGT III</sub>			III	—	—	1.5	V
I <sub>FGT I</sub>	Gate trigger current *2	T <sub>j</sub> =25°C, V <sub>D</sub> =6V, R <sub>L</sub> =6Ω, R <sub>G</sub> =330Ω	I	—	—	30	mA
I <sub>RGT I</sub>			II	—	—	30	mA
I <sub>RGT III</sub>			III	—	—	30	mA
V <sub>GD</sub>	Gate non-trigger voltage	T <sub>j</sub> =125°C, V <sub>D</sub> =1/2V <sub>DRM</sub>	0.2	—	—	V	
R <sub>th (j-c)</sub>	Thermal resistance	Junction to case (BCR16A, BCR16B, BCR16C)	—	—	1.2	°C/W	
R <sub>th (j-b)</sub>		Junction to base (BCR16E)	—	—	2.5	°C/W	
(dv/dt) <sub>c</sub>	Critical-rate of rise of off-state commutating voltage		*3	—	—	V/μs	

\*2. Measurement using the gate trigger characteristics measurement circuit.

\*3. The critical-rate of rise of the off-state commutating voltage is shown in the table below.

Voltage class	V <sub>DRM</sub> (V)	(dv/dt) <sub>c</sub>			Test conditions	Commutating voltage and current waveforms (inductive load)
		Symbol	Min.	Unit		
8	400	R	—	V/μs	1. Junction temperature T <sub>j</sub> =125°C 2. Rate of decay of on-state commutating current (di/dt) <sub>c</sub> =-8A/ms 3. Peak off-state voltage V <sub>D</sub> =400V	
		L	10			
10	500	R	—			
		L	10			

# BCR16A, BCR16B, BCR16C, BCR16E

MEDIUM POWER USE

A, B, C : NON-INSULATED TYPE, E : INSULATED TYPE, GLASS PASSIVATION TYPE

## OUTLINE DRAWING

Dimensions in mm

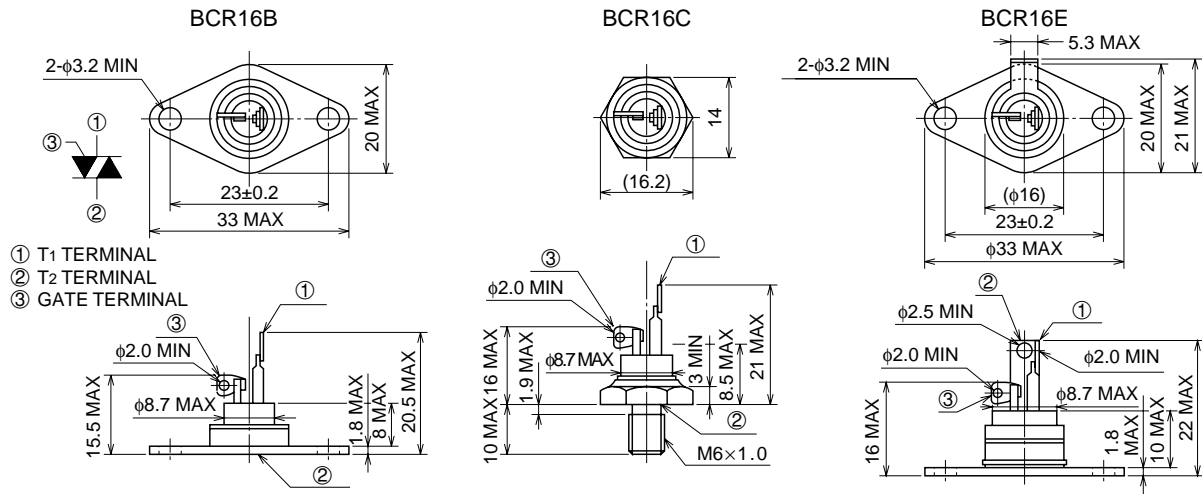

## PERFORMANCE CURVES

MAXIMUM ON-STATE CHARACTERISTICS

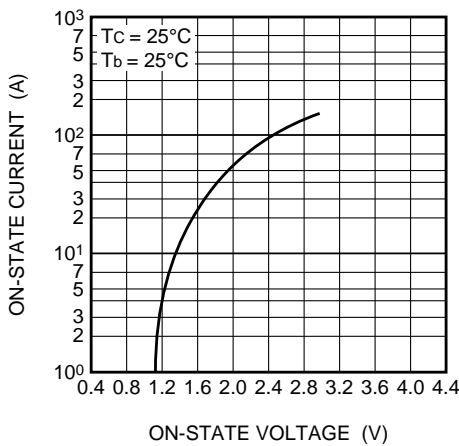

RATED SURGE ON-STATE CURRENT

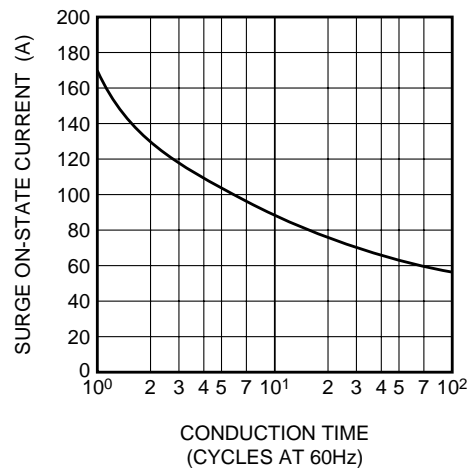

GATE CHARACTERISTICS

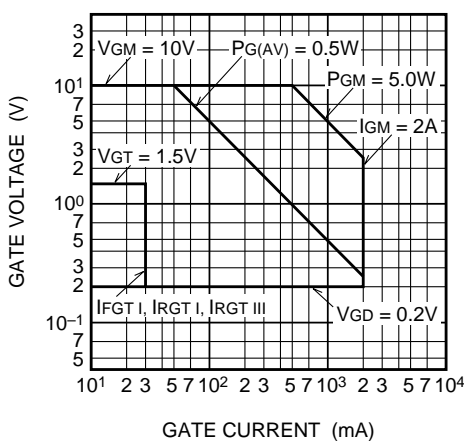

GATE TRIGGER CURRENT-VOLTAGE VS. JUNCTION TEMPERATURE

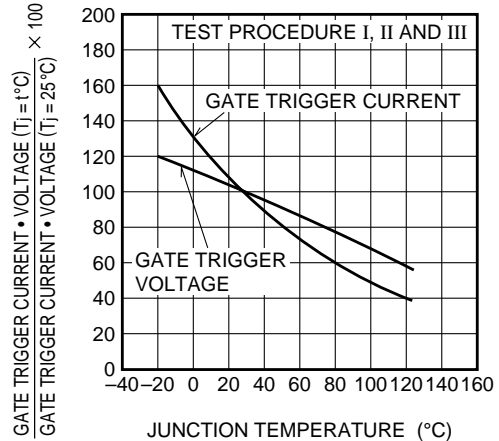

# BCR16A, BCR16B, BCR16C, BCR16E

MEDIUM POWER USE

A, B, C : NON-INSULATED TYPE, E : INSULATED TYPE, GLASS PASSIVATION TYPE

**MAXIMUM TRANSIENT THERMAL IMPEDANCE CHARACTERISTICS (JUNCTION TO CASE) (BCR16A, B, C)**

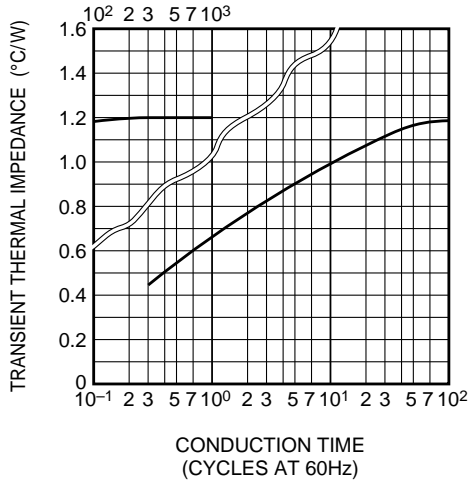

**MAXIMUM TRANSIENT THERMAL IMPEDANCE CHARACTERISTICS (JUNCTION TO BASE) (BCR16E)**

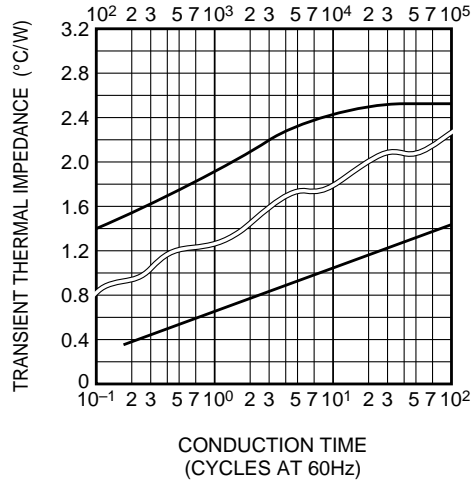

**MAXIMUM ON-STATE POWER DISSIPATION**

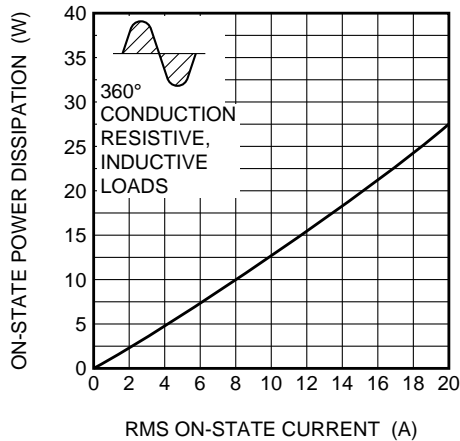

**ALLOWABLE CASE TEMPERATURE VS. RMS ON-STATE CURRENT**

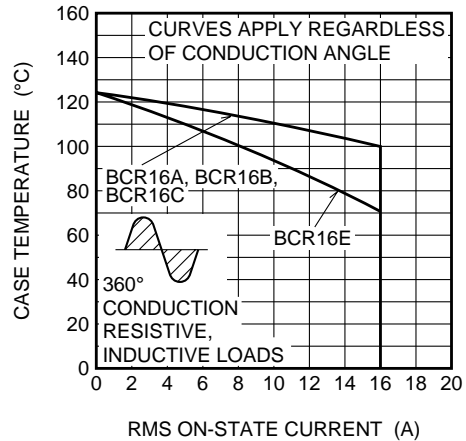

**ALLOWABLE AMBIENT TEMPERATURE VS. RMS ON-STATE CURRENT (BCR16A)**

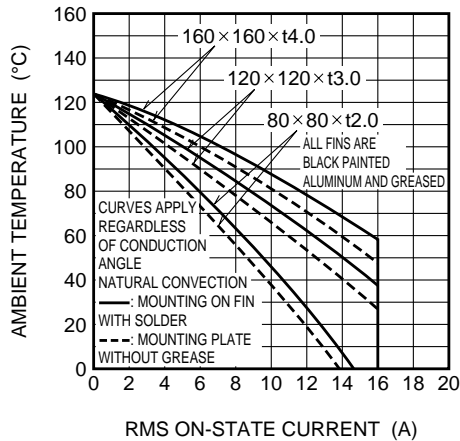

**ALLOWABLE AMBIENT TEMPERATURE VS. RMS ON-STATE CURRENT (BCR16B)**

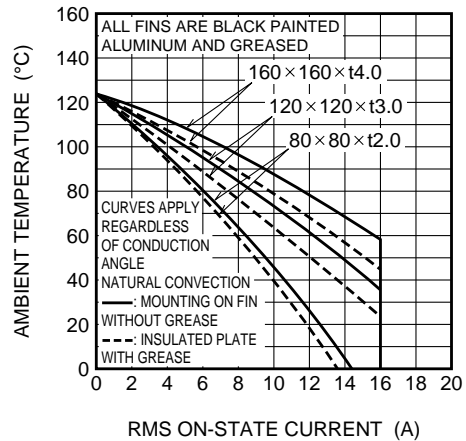

# BCR16A, BCR16B, BCR16C, BCR16E

MEDIUM POWER USE

A, B, C : NON-INSULATED TYPE, E : INSULATED TYPE, GLASS PASSIVATION TYPE

**ALLOWABLE AMBIENT TEMPERATURE VS. RMS ON-STATE CURRENT (BCR16C)**

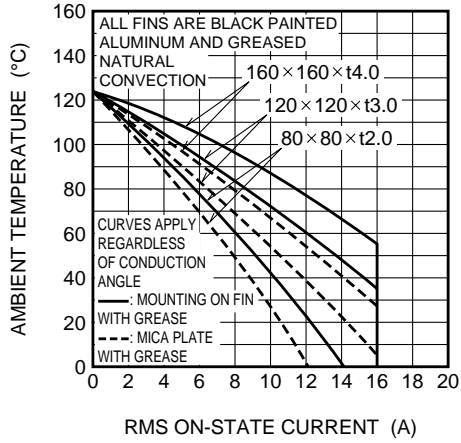

**ALLOWABLE AMBIENT TEMPERATURE VS. RMS ON-STATE CURRENT (BCR16E)**

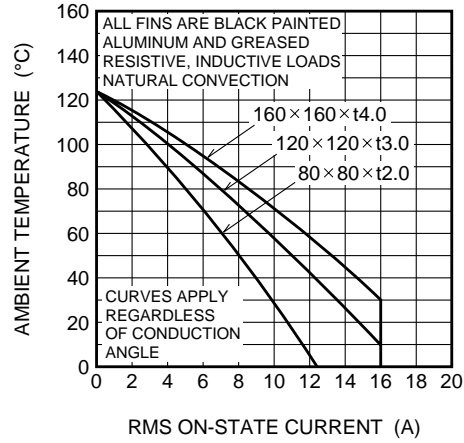

**GATE TRIGGER CHARACTERISTICS TEST CIRCUITS**

