



# *COIN CELL*

## *CR2477*

### **BRIEF SPECIFICATION**

Model: CR2477

Nominal Voltage: 3.0V

Nominal Capacity: 1000mAh

Standard Discharge with load: 1.5K $\Omega$

Weight: 9.5g

Stainless steel container

ISO9001 Certified

UL Certified MH20555

Manufacturer: EEMB Co., Ltd.

Website: <http://eemb.com>

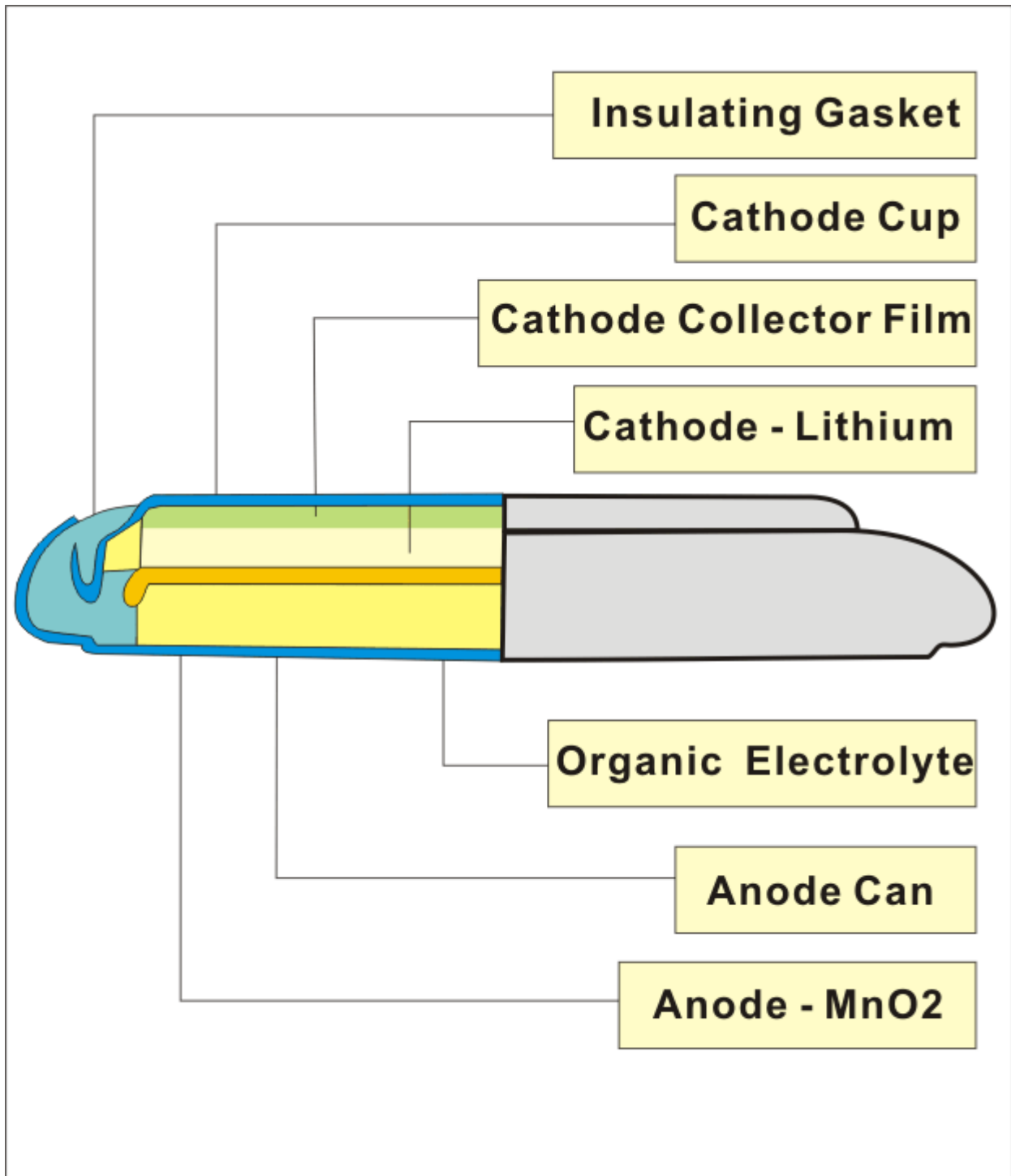
*Lithium Coin battery structure*

Note: Any representations in this brochure concerning performance, are for informational purposes only and are not construed as warranties either expressed or implied, of future performance.

## EEMB CR2477 Coin Cell STANDARD SPECIFICATION

### CONTENT

1. SUBJECT
2. GENERAL FEATURES AND APPLICATIONS
3. GENERAL SPECIFICATIONS
4. PERFORMANCE AND TEST METHODS
5. VISUAL ASPECT
6. PRECAUTIONS IN USING
7. STORAGE AND MOUNT
8. SAFETY
9. BATTERY CHARACTERISTICS
10. UNTAGGED CELL DIMENSIONS
11. MEMORY BACKUP CIRCUIT DESIGN SUGGESTION

---

### 1. SUBJECT

This specification presents typical and guaranteed ex-work values of the Lithium Manganese Dioxide Coin Cells (Li / MnO<sub>2</sub>), of Model CR2477

Manganese dioxide (MnO<sub>2</sub>) is used for the active cathode material, and high voltage, high activity lithium metal for the anode material. Battery discharge reactions are as follows:

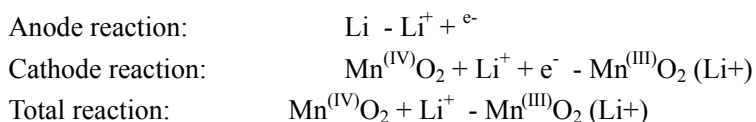

### 2. Li-MnO<sub>2</sub> BUTTON CELL FEATURES AND APPLICATIONS

*Features:*

- Light Weight, High Voltage and High Energy Density
- Excellent Stable Discharge Characteristics
- Outstanding Temperature Characteristics
- Excellent Leakage Resistance
- Excellent Long-term Reliability

Note: Any representations in this brochure concerning performance, are for informational purposes only and are not construed as warranties either expressed or implied, of future performance.

*Applications:*

- Watches
- Calculators
- PC notebooks
- Electronic Keys
- Card-Type Radios
- IC Cards
- Memory Cards
- Medical Equipment
- CMOS memory backup

### 3. GENERAL SPECIFICATION

#### 3.1

Item	Unit	Specifications	Conditions
Nominal Voltage	V	3.0	Standard Discharge
Nominal Capacity	mAh	1000	Standard discharge with load 1.5kΩ
Storage temperature	°C	0~35	
Operation temperature	°C	-20~70	
Standard Weight	g	9.5	Unit cell
Dimension	Diameter	24.5(-0.3mm)	
	Height	7.7 (-0.3mm)	

#### 3.2

Item	Conditions	Characteristics
Self-discharge rate	Stored for 12 months at room temperature	≤3%

### 4. PERFORMANCE AND TEST METHODS

Unless otherwise stated, all the testing is carried out under the condition: environmental temperature, 20°C~25°C; environmental humidity, 65±20%. Please refer to Table 4.1

Note: Any representations in this brochure concerning performance, are for informational purposes only and are not construed as warranties either expressed or implied, of future performance.

#### 4.1 Characteristics

No	ITEM	TEST METHODS	STANDARD	
1	Dimensions	Using vernier caliper (accuracy $\geq$ 0.02) while avoiding short-circuit	Diameter	24.5 (-0.3) mm
			Height	7.7 (-0.3) mm
2	Appearance	Eyeballing	Bright, clean, no rust, no leakage, and no flaw.	
3	Capacity	Put the battery under the condition of 20~25°C and 65 $\pm$ 20%RH for 8 hours, then continuously discharge with load 1.5k $\Omega$ to end-off voltage of 2.0V. (For fresh battery only: within 3 months)	$\geq$ 500h	
4	Vibration test	Put battery on the platform of the vibrations machine, start the machine and adjust the frequency from 10 times per minute to 15 times per minute. keep it running for an hour	Characteristics keep stability	
5	Leakage at high temperature	Store under temperature (45°C) for 30 days	Leakage rate $\leq$ 0.6%	
6	Over discharge Test	After 2.0V end-voltage, continuously discharged for 5 hours.	No leakage allowed	

**Note:** Typical values relative to cells stored for three month or less at + 30°C max.

#### 5. VISUAL ASPECT

The cell must not show any trace of the following:

- a) Dents; Bulging; Leakage; Corrosion

#### 6. PRECAUTIONS IN USING

- Use Nickel-plated iron or stainless steel for the terminals that contact the battery.
- Make sure that terminal contact pressure is 50g minimum, for a stable contact.
- Keep the battery and contact terminal surfaces clean and free from moisture and foreign matter.
- Before inserting the battery, check the battery contact terminals to make sure they are normal, not bent or damaged. (Bent terminals may not make good contact with the battery or may cause it to short circuit.)
- When the batteries are piled up in a disorderly way, their positive and negative terminals may short-circuit, consuming some batteries while charging others, causing them to explode.
- Lithium batteries that are almost exhausted can output a voltage that is almost the same as that of a new battery: Please does not judge a battery only with a Voltmeter. Avoid using a mixture of old and new batteries; replace all batteries in a set with new one.
- Lithium batteries require a period of time to reach their normal voltage again after even a slight short circuit. Therefore, should the battery is short-circuited, wait an adequate long time for batteries to recover before measuring their electrical characteristics.
- Use a high impedance (1M or higher) voltmeter to measure battery voltage.
- Battery characteristics vary with type and grade, even when batteries are the same size and shape. When replacing batteries with new ones, be sure to carefully check the symbols and numbers on them.

**Note:** Any representations in this brochure concerning performance, are for informational purposes only and are not construed as warranties either expressed or implied, of future performance.

## 7. STORAGE AND MOUNT

The cell should be preferably stored in dry and cool conditions.

+60 °C 120 days stored condition is the equivalent of 6 years at room temperature (+21 °C)

Button lithium batteries need special method to avoid short-circuiting before and after they are installed. As short circuits tend to occur in the following cases, please take care when handing the batteries.

### 7.1. Overlapping Batteries

A Button lithium battery is shaped as shown below. It has exposed positive and negative metallic surfaces with a thin cylindrical seal, called the gasket, in between.

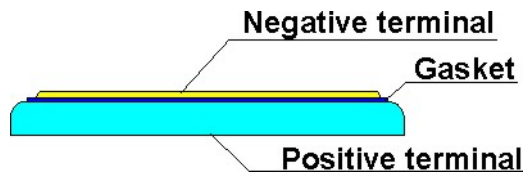

When batteries are overlapped or mixed together in a disorder way, their positive and negative terminals touch each other, causing short circuits.



### 7.2. Batteries put in a Metallic Container or on a Metallic Plate

Similar to the overlapping battery problem, when batteries are put in a metallic container or on a metallic plate, their positive and negative terminals may short circuit through the conductive surface depending on the placement

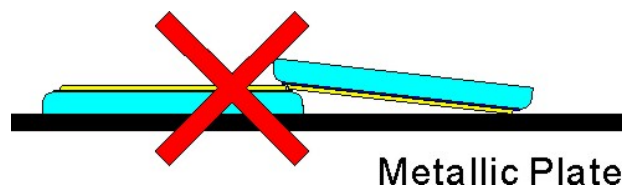

### 7.3. When a Battery is Held with Tweezers

When held with a pair of metallic tweezers as shown below, the battery short-circuits through the tweezers



### 7.4. When Battery Lead Plates Touch Each Other

When battery lead plates bend and touch each other or either terminal, the battery short-circuits.



Note: Any representations in this brochure concerning performance, are for informational purposes only and are not construed as warranties either expressed or implied, of future performance.

### 7.5. Solder Bridges

Solder may bridge between board conductors, short-circuiting and draining battery.

### 7.6. Short-circuited though Soldering Iron

Similar to solder bridging, when the circuit board wiring is short-circuited by a soldering iron for an extended period, the battery is drained and consumed. Complete manual soldering within 5 seconds.

### 7.7. Shorts through Piled Circuit Board

When circuit boards with batteries are piled on top of one another, their conductive traces may touch, and form a battery discharge circuit that consumes the battery's power.

### 7.8. Discharge through Conductive Electrostatic Prevention Mats

Conductive mats are widely used to prevent static electricity from destroying semiconductors. If a circuit board with a battery mounted in put on a conductive mat, the soldered conductors may touch the mat, providing a discharge path for the battery.

### 7.9. Improper Battery Mounting Polarity

When the battery's positive (+) and negative (-) terminals are backward with respect to the battery mounting's polarity marks, the battery may be discharged, depending on the type of electric circuit.

### 7.10. Solder

When the battery's lead plates are dipped in a molten solder bath, the battery is temporarily short-circuited. Therefore, complete dipping within 5 seconds.

## 8. SAFETY

### Battery Handling Precautions to Ensure Complete Safety

Lithium batteries contain inflammable materials, such as lithium and organic solvents. Improper battery handling, particularly during transit and storage, may cause heating, explosions and fires.

*Please strictly observe the precautions below in handling lithium batteries.*

#### **WARNING!**

- DO NOT recharge, short-circuit, disassemble, deform, heat or place the battery near a direct flame. This battery contains flammable materials such as lithium and organic solvent and performing any of the above actions could cause it to ignite explode or become damaged.
- Keep this battery out of the reach of children. If it is swallowed, contact a physician immediately.
- When storing the battery or throwing it away, be sure to cover it with tape. If the battery comes into contact with other metal objects, it could ignite or become damaged.

#### **CAUTION!**

**Closely observe the following precautions. If the battery is used incorrectly, it could leak or become damaged, causing device trouble or injury.**

- Insert the battery with the "+" and "-" ends correctly oriented.
- If the battery is used together with new batteries, do not use it with a different type of battery.
- Do not apply solder directly to the battery.
- Avoid storing the battery in direct sunlight, or in excessively hot and humid locations.

Note: Any representations in this brochure concerning performance, are for informational purposes only and are not construed as warranties either expressed or implied, of future performance.

**9. DISCHARGE CHARACTERISTICS**

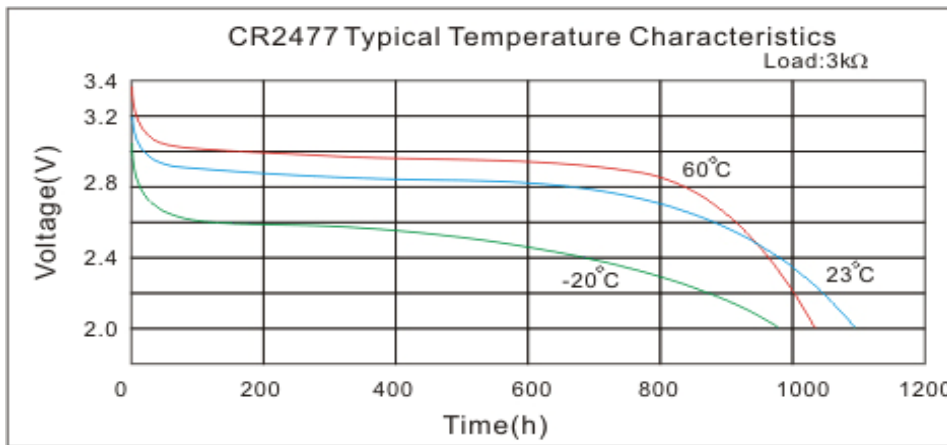
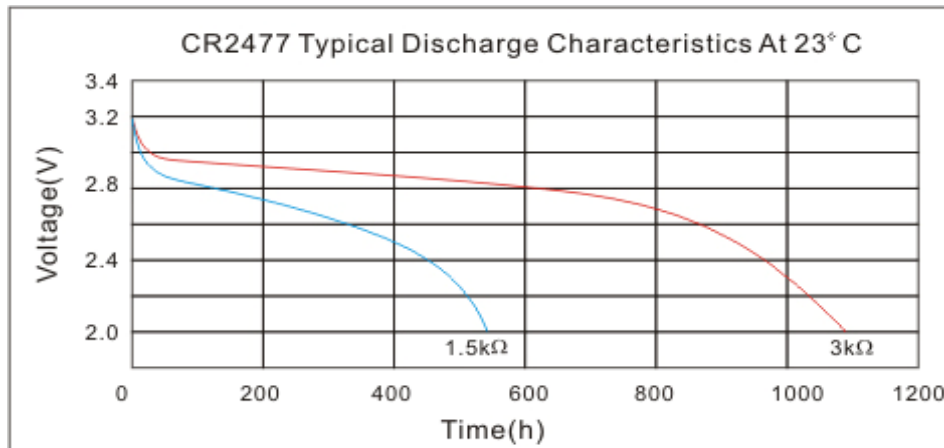

**10. UNTAGGED CELL DIMENSIONS**

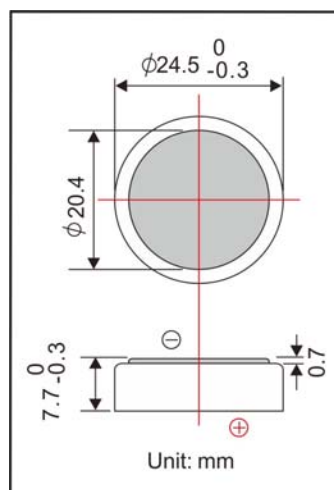

Note: Any representations in this brochure concerning performance, are for informational purposes only and are not construed as warranties either expressed or implied, of future performance.



## 11. MEMORY BACKUP CIRCUIT DESIGN SUGGESTION

A primary lithium battery is not rechargeable, when used for memory backup in combination with another power source, current may flow into the battery from the other source. To prevent this, design a protection diode and resistor into the circuit so that no battery charging or over discharging can occur.

### 11.1 Allowable Range of Diode Back-Leak-Leakage Current

To protect the battery from being charged by the main power source, be sure to use a back-current prevention diode and a protection resistor. Select a silicon diode or a diode with minimum leakage current, and design the circuit so that the amount of charging due to leakage current will not exceed 2% of the nominal battery capacity over the total period of use.

### 11.2. Maximum Allowable Charge Current to Battery

A protection resistor is needed to prevent diode failure from allowing a large current to flow into the battery.

