

14118 Stowe Drive, Suite B  
 Poway, CA 92064  
 TEL: (858) 621-2700 | FAX: (858) 486-1927  
 URL: www.zcomm.com  
 EMAIL: applications@zcomm.com

## Voltage-Controlled Oscillator Surface Mount Module

### Applications

- Digital Radio Equipment
- Fixed Wireless Access
- 

### Application Notes

- AN-101: Mounting and Grounding
- AN-102: Output Loading
- AN-107: Manual Soldering

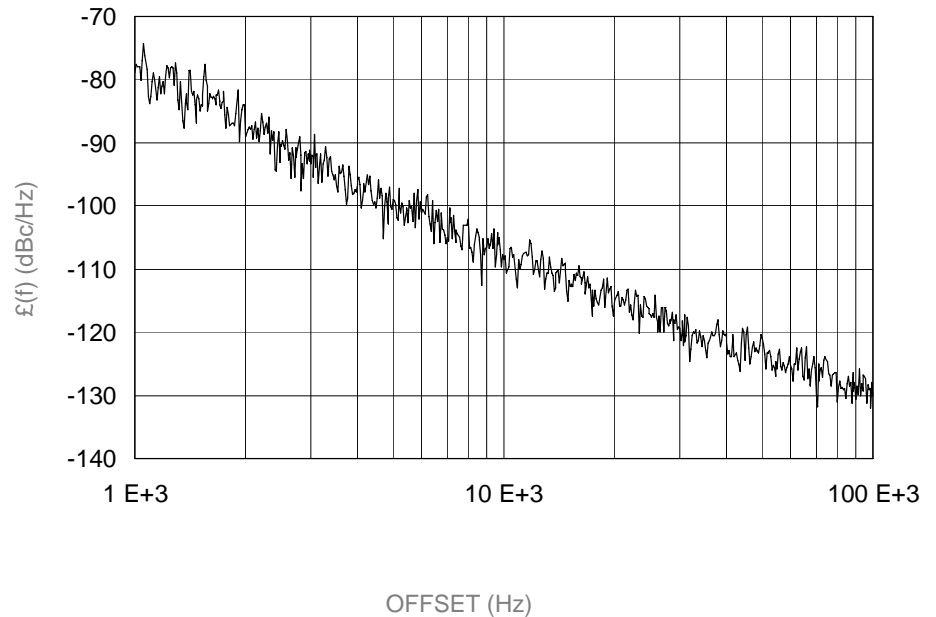

Performance Specifications	Min	Typ	Max	Units
Oscillation Frequency Range	2640		2710	MHz
Phase Noise @ 10 kHz offset (1 Hz BW)		-109		dBc/Hz
Harmonic Suppression (2nd)		-15	-20	dBc
Tuning Voltage	0.5		4.5	Vdc
Tuning Sensitivity (avg.)		30		MHz/V
Power Output	0	3	6	dBm
Load Impedance		50		$\Omega$
Input Capacitance			50	pF
Pushing			2	MHz/V
Pulling (14 dB Return Loss, Any Phase)			1	MHz
Operating Temperature Range	-40		85	$^{\circ}\text{C}$
Package Style	MINI-16-SM			

Power Supply Requirements	Min	Typ	Max	Units
Supply Voltage (Vcc, nom.)		5		Vdc
Supply Current (Icc)		21	25	mA

### Additional Notes

Tuning Curve, typ.

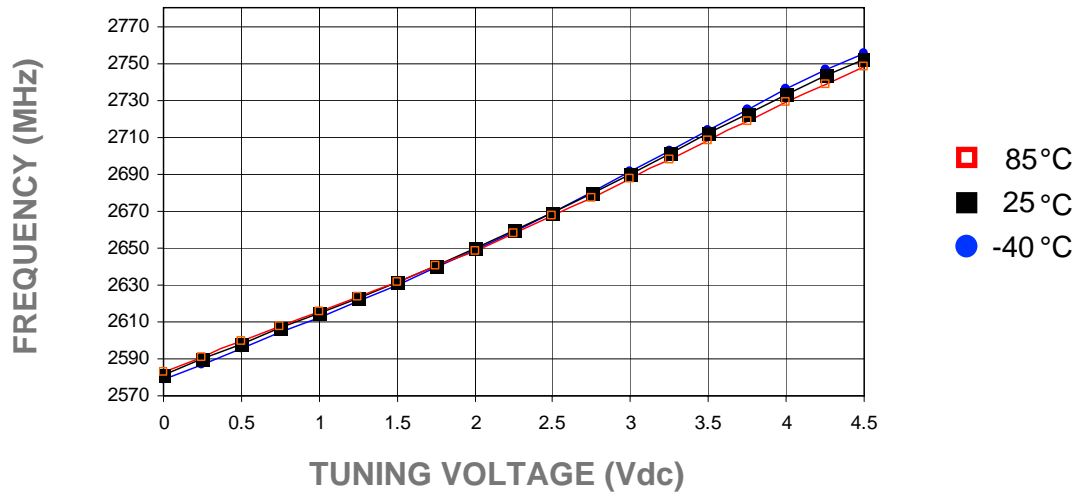

Power Curve, typ.

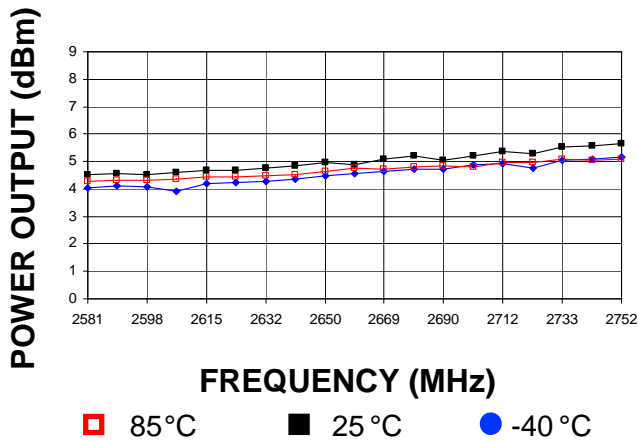

Footprint

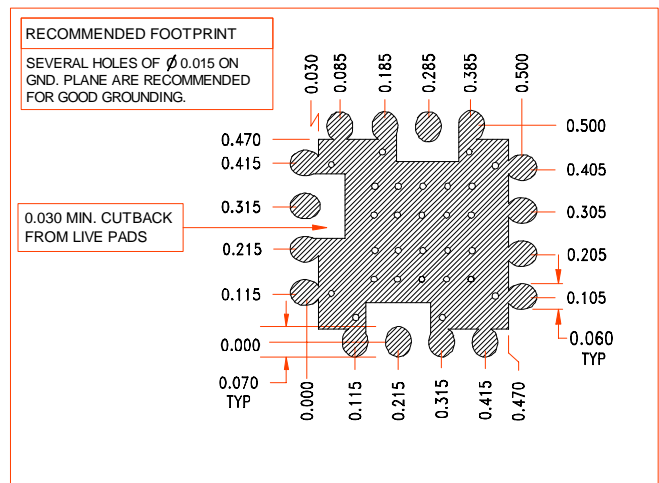

Physical Dimensions



LFSuffix = RoHS Compliant. All specifications are subject to change without notice.