

General Description

This product family is CRM's second generation SiC JBS, with lower VF and offers state of the art performance. It is designed for high frequency applications where high efficiency and high reliability are required. It is qualified and manufactured on the productive 6 inch SiC line in China fully owned by CR MICRO.

Product Summary

V_{RRM}	1200 V
$I_F (T_C=155^\circ\text{C})$	30 A
Q_C	135 nC

Features

- Low conduction loss due to low V_F
- Extremely low switching loss by tiny Q_C
- Highly rugged due to better surge current
- Industrial standard quality and reliability



Applications

- Solar inverter
- EV charge
- High performance SMPS
- Power factor correction

TO-263

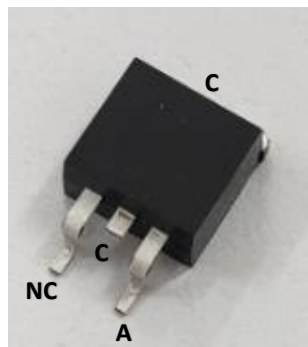

Equivalent circuit



Package Marking and Ordering Information

Part #	Marking	Package
CRXB30D120G2	CRXB30D120G2	TO-263

Maximum Ratings (at $T_c = 25\text{ }^\circ\text{C}$, unless otherwise specified)

Parameter	Symbol	Value	Unit
Repetitive Peak Reverse Voltage	V_{RRM}	1200	V
Surge Peak Reverse Voltage	V_{RSM}	1200	V
DC Peak Reverse Voltage	V_R	1200	V
Continuous Forward Current $T_c = 25^\circ\text{C}$ $T_c = 135^\circ\text{C}$ $T_c = 155^\circ\text{C}$	I_F	83 43 30	A
Non-Repetitive Forward Surge Current $T_c = 25^\circ\text{C}, t_p=8.3\text{ms}, \text{Half Sine Pulse}$ $T_c = 110^\circ\text{C}, t_p=8.3\text{ms}, \text{Half Sine Pulse}$	I_{FSM}	240 210	A
Non-Repetitive Forward Surge Current $T_c = 25^\circ\text{C}, t_p=8.3\text{ms}, \text{Half Sine Pulse}$ $T_c = 110^\circ\text{C}, t_p=8.3\text{ms}, \text{Half Sine Pulse}$	$\int i^2 dt$	239 183	A^2s
Power dissipation $T_c = 25^\circ\text{C}$ $T_c = 110^\circ\text{C}$	P_{tot}	272 118	W
Operating junction Range	T_j	-55 to +175	$^\circ\text{C}$
Storage temperature Range	T_{stg}	-55 to +150	$^\circ\text{C}$

Thermal Resistance

Parameter	Symbol	Typ.	Unit
Thermal resistance, junction – case.	R_{thJC}	0.55	°C/W

Electrical Characteristic (at $T_c = 25\text{ °C}$, unless otherwise specified)

Parameter	Symbol	Value			Unit	Test Condition
		min.	typ.	max.		
Forward Voltage	V_F	-	1.4	1.7	V	$I_F=30A$ $T_j=25\text{°C}$ $T_j=175\text{°C}$
Reverse Current	I_R	-	5	100	μA	$V_R=1200V$ $T_j=25\text{°C}$ $T_j=175\text{°C}$
Total Capacitive Charge	Q_C	-	135	-	nC	$V_R=800V, T_j=25\text{°C}$ $Q_C = \int_0^{V_R} C(V)dV$
Total Capacitance	C	-	2050	-	pF	$T_j=25\text{°C}, f=1MHz$ $V_R=0V$ $V_R=400V$ $V_R=800V$

Characteristics Curve:

Fig 1: Forward Characteristics

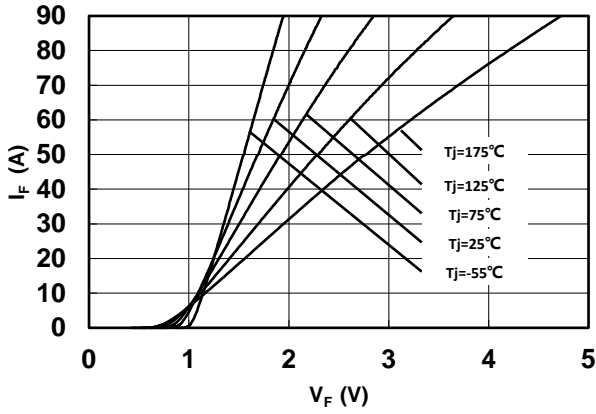

Fig 2: Reverse Characteristics

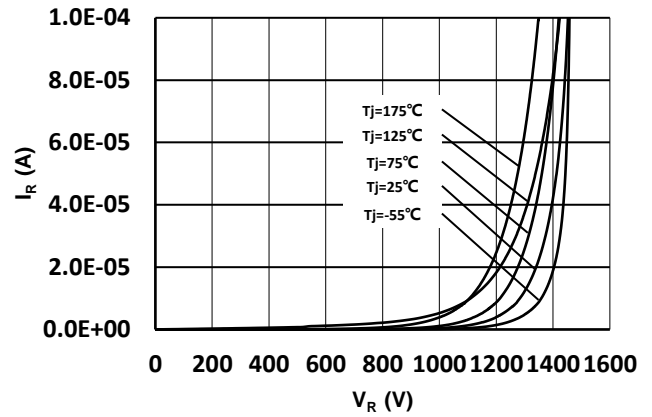

Fig 3: Current Derating

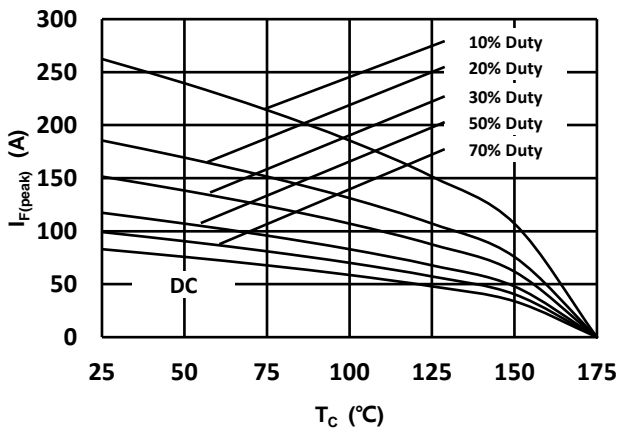

Fig 4: Power Derating

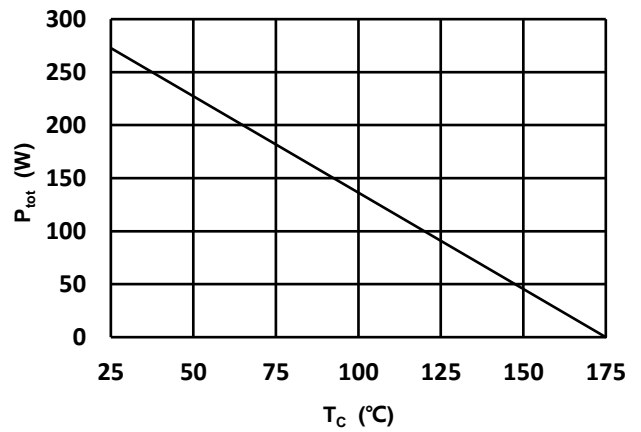

Fig 5: Capacitance vs. Reverse Voltage

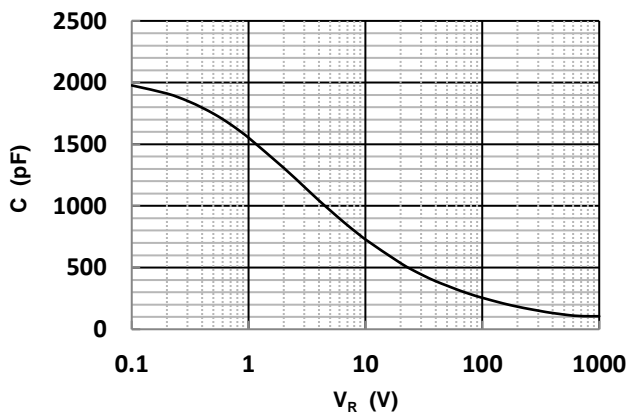

Fig 6: Reverse Charge vs. Reverse Voltage

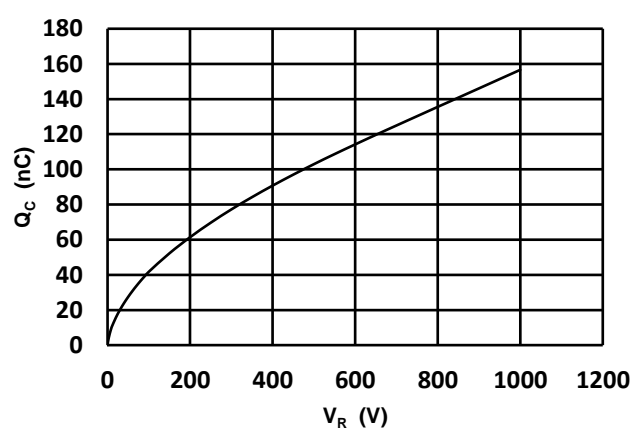

Fig 7: Typical Capacitance Stored Energy

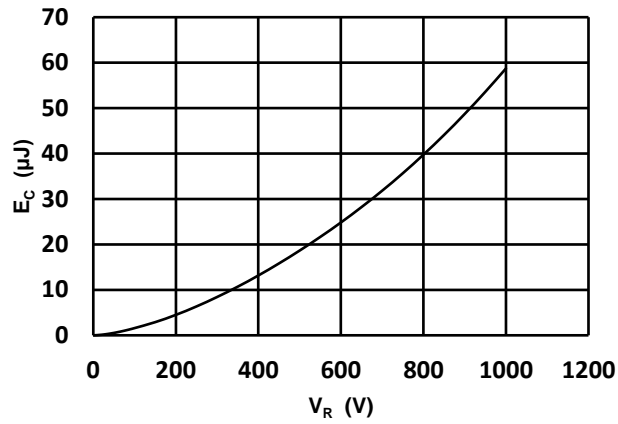
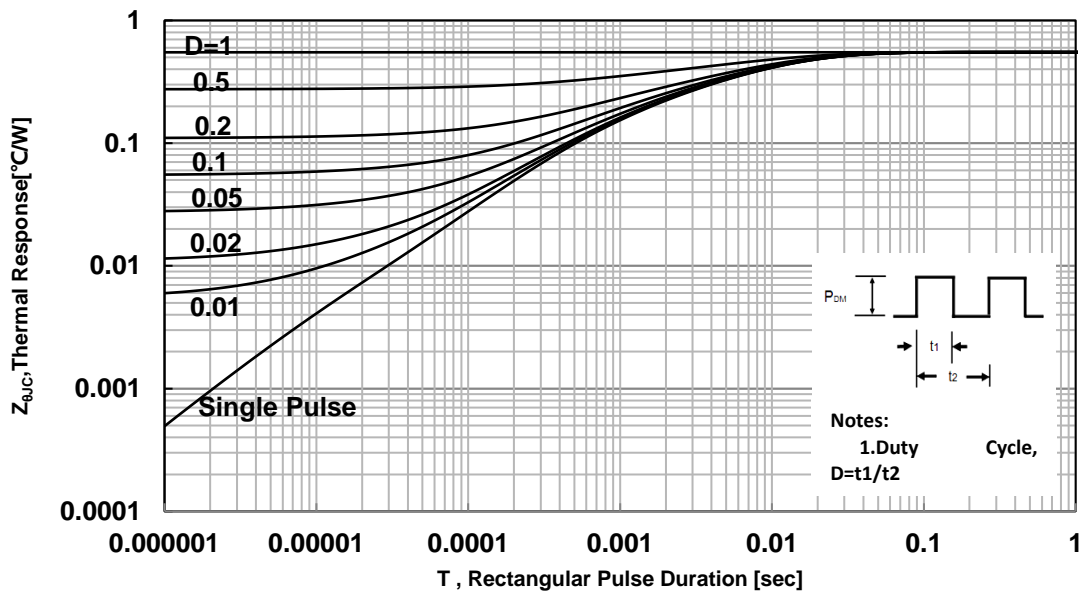
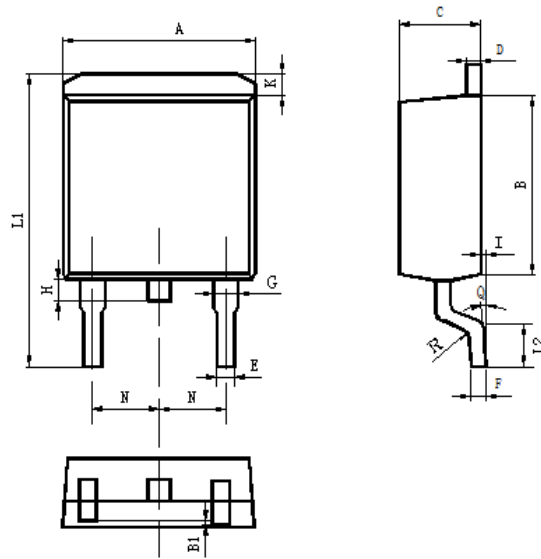

Fig 8: Transient Thermal Impedance



Package Outline: TO-263



Items	Values(mm)	
	MIN	MAX
A	9.80	10.40
B	8.90	9.50
B1	0.00	0.10
C	4.40	4.80
D	1.16	1.37
E	0.70	0.95
F	0.30	0.60
G	1.07	1.47
H	1.30	1.80
K	0.95	1.37
L1	14.50	16.50
L2	1.60	2.30
I	0.00	0.20
Q	0°	8°
R	0.40	
N	2.39	2.69

Revision History

Revision	Date	Major changes
1.0		Release of formal version.

Warnings

Exceeding the maximum ratings of the device in performance may cause damage to the device, even the permanent failure, which may affect the dependability of the machine. It is suggested to be used under 80 percent of the maximum ratings of the device.

1. When installing the heatsink, please pay attention to the torsional moment and the smoothness of the heatsink.
2. This product has not been designed or tested for use in, and is not intended for use in, applications implanted into the human body nor in applications in which failure of the product could lead to death, personal injury or property damage, including but not limited to equipment used in the operation of nuclear facilities, life-support machines, cardiac defibrillators or similar emergency medical equipment, aircraft navigation or communication or control systems, or air traffic control systems.