

Features

- High Blocking Voltage with Low On-Resistance
- High Speed Switching with Low Capacitances
- Easy to Parallel and Simple to Drive
- Avalanche Ruggedness
- Fast Reverse Recovery
- Halogen Free, RoHS Compliant

Applications

- Solar Inverters
- Switch Mode Power Supplies
- High Voltage DC/DC Converters
- On Board Charger

Product Summary

V _{DS}	650V
R _{DS(on)_typ}	60mΩ
I _D	37A

100% Avalanche Tested

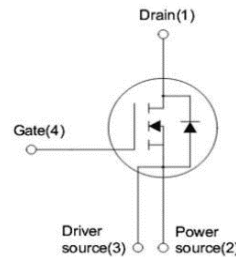
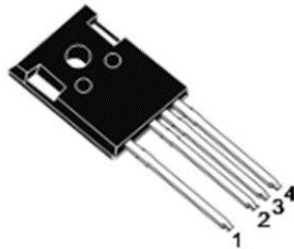

Package Marking and Ordering Information

Part #	Marking	Package	Packing	Reel Size	Tape Width	Qty
CRXQF60M065G1	-	TO-247-4L	Tube	N/A	N/A	25pcs

Absolute Maximum Ratings

Parameter	Symbol	Value	Unit
Drain-source voltage	V _{DSmax}	650	V
Continuous drain current V _{GS} =20V, T _C = 25°C V _{GS} =20V, T _C = 100°C	I _D	37 26	A
Pulsed drain current (T _C = 25°C, t _p limited by T _{jmax})	I _{D(pulse)}	93	A
Avalanche energy, single pulse (L=10mH, R _g =25Ω)	E _{AS}	590	mJ
Gate-Source voltage (dynamic)	V _{GSmax}	-10/+25	V
Gate-Source voltage (static)	V _{GSop}	-5/+20	V
Power dissipation (T _C =25°C, T _j =175°C)	P _D	183	W
Operating junction temperature	T _j	-55...175	°C
Storage temperature	T _{stg}	-55...150	°C

Thermal Resistance

Parameter	Symbol	Value	Unit
Thermal resistance, junction – case. Max	R_{thJC}	0.82	°C/W
Thermal resistance, junction – ambient. Max	R_{thJA}	40	

Electrical Characteristic (at $T_j = 25\text{ °C}$, unless otherwise specified)

Parameter	Symbol	Value			Unit	Test Condition
		min.	typ.	max.		

Static Characteristic

Drain-source breakdown voltage	$V_{(BR)DSS}$	650	-	-	V	$V_{GS}=0V, I_D=250\mu A$
Gate threshold voltage	$V_{GS(th)}$	2	-	4	V	$V_{DS}=V_{GS}, I_D=5mA$
Zero gate voltage drain current	I_{DSS}	-	1	100	μA	$V_{DS}=650V, V_{GS}=0V$ $T_j=25\text{ °C}$
		-	10	-		
Gate-source leakage current	I_{GSS}	-	-	250	nA	$V_{GS}=20V, V_{DS}=0V$
Drain-source on-state resistance	$R_{DS(on)}$	-	60	-	$m\Omega$	$V_{GS}=18V, I_D=13.2A$
		-	52	70	$m\Omega$	$V_{GS}=20V, I_D=13.2A,$ $T_j=25\text{ °C}$
		-	77	-		$T_j=175\text{ °C}$
Transconductance	g_{fs}	-	7.4	-	S	$V_{DS}=20V, I_{DS}=13.2A$

Dynamic Characteristic

Internal Gate resistance	$R_{G(int)}$	-	3.4	-	Ω	$f=1MHz$
Input Capacitance	C_{iss}	-	1190	-	pF	$V_{GS}=0V, V_{DS}=650V,$ $f=1MHz$
Output Capacitance	C_{oss}	-	129	-		
Reverse Transfer Capacitance	C_{rss}	-	13	-		
Coss Stored Energy	E_{oss}	-	29	-	μJ	$V_{DS}=650V$
Gate Total Charge	Q_g	-	68	-	nC	$V_{GS}=-5/20V$ $V_{DS}=400V$ $I_D=13.2A$
Gate-Source charge	Q_{gs}	-	16	-		
Gate-Drain charge	Q_{gd}	-	17	-		
Turn-on delay time	$t_{d(on)}$	-	16	-	ns	$V_{DD}=400V, I_D=13.2A$ $V_{GS}=-5V/20V,$ $R_G=10\Omega, L=100\mu H$
Rise time	t_r	-	21	-		
Turn-off delay time	$t_{d(off)}$	-	38	-		
Fall time	t_f	-	13	-		
Turn-On Switching Energy	$E_{(on)}$	-	134	-	μJ	
Turn Off Switching Energy	$E_{(off)}$	-	8.7	-		

Body Diode Characteristic

Parameter	Symbol	Value			Unit	Test Condition
		min.	typ.	max.		
Body Diode Forward Voltage	V_{SD}	-	3.3	-	V	$V_{GS}=0V, I_F=6.6A$
		-	2.6	-	V	$V_{GS}=0V, I_F=6.6A, T_j=175^{\circ}C$
Body Diode Reverse Recovery Time	t_{rr}	-	14	-	ns	$di/dt=1860A/us$ $I_F=13.2A$ $V_{dd}=400V$
Body Diode Reverse Recovery Charge	Q_{rr}	-	72	-	nC	
Body Diode Peak Reverse Recovery Current	I_{rrm}	-	8.7	-	A	

Typical Performance Characteristics

Fig 1. Output Characteristics ($T_j = -55^\circ\text{C}$)

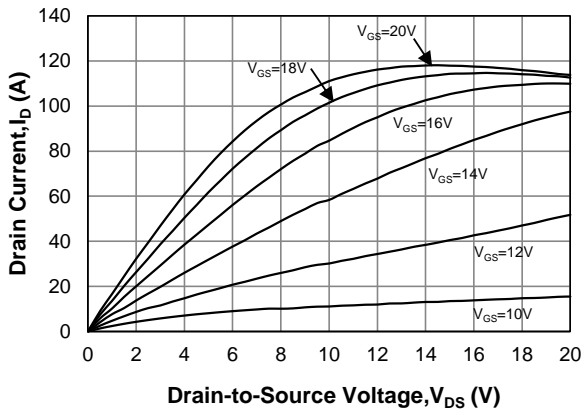

Fig 2. Output Characteristics ($T_j = 25^\circ\text{C}$)

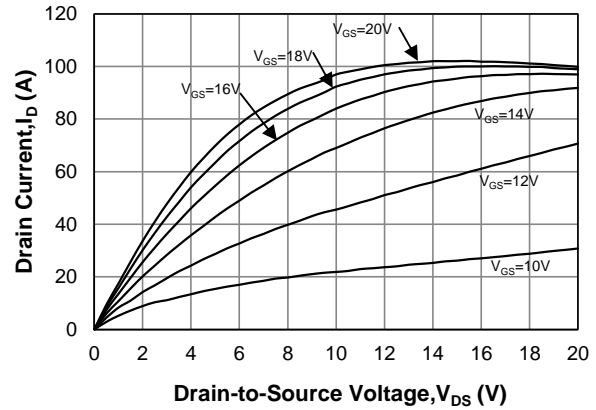

Fig 3. Output Characteristics ($T_j = 175^\circ\text{C}$)

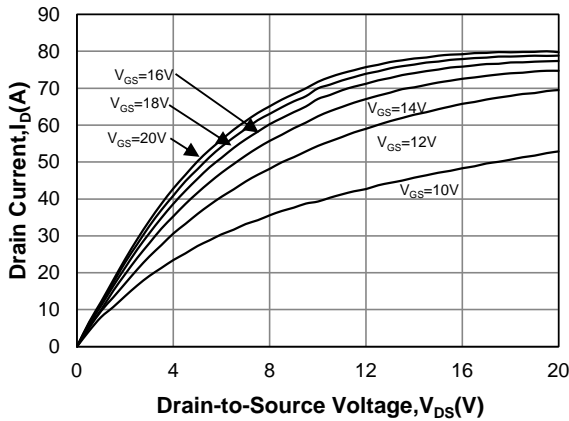

Fig 4: $R_{DS(on)}$ vs. Temperature

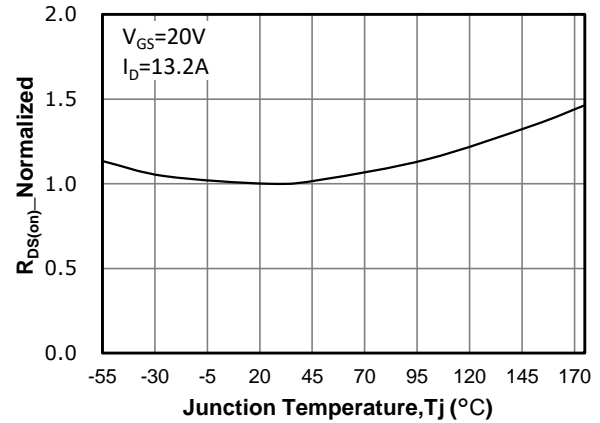

Fig 5: On-Resistance vs. Drain Current For Various Temperatures

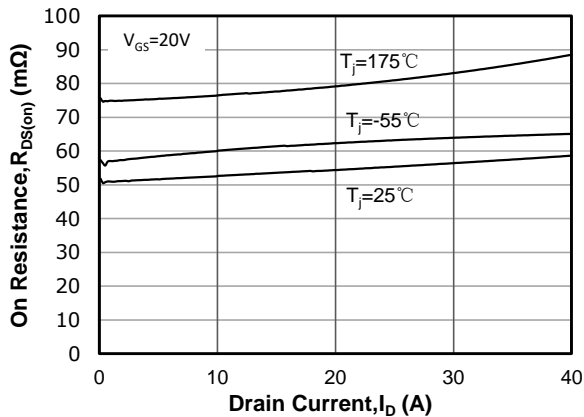

Fig 6: $R_{DS(on)}$ vs. Temperature For Various Gate Voltage

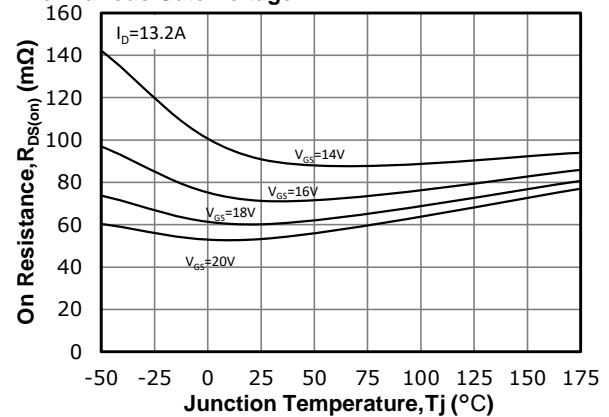

Fig 7: Transfer Characteristics

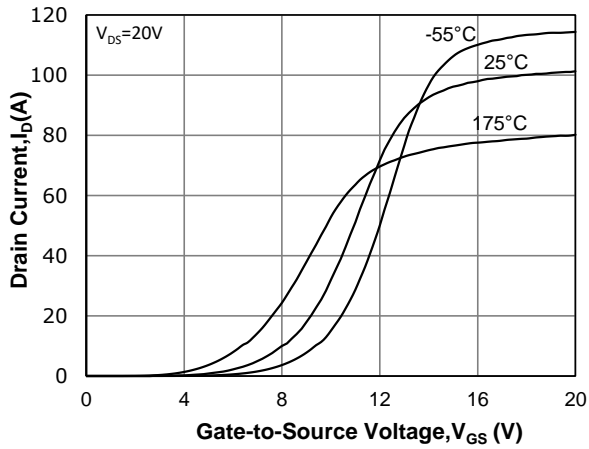

Fig 8: Body-diode Forward Characteristics For Various Temperatures

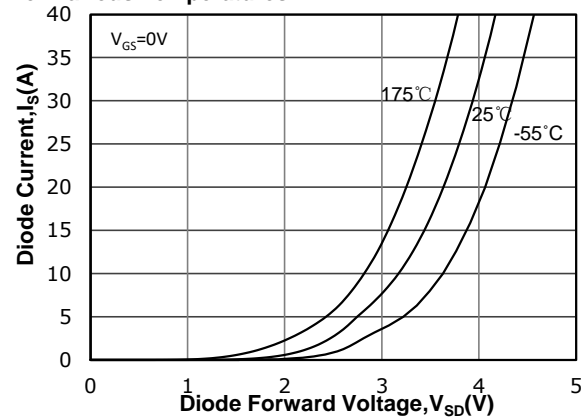

Fig 9: VGS(th) Vs Tj Characteristics

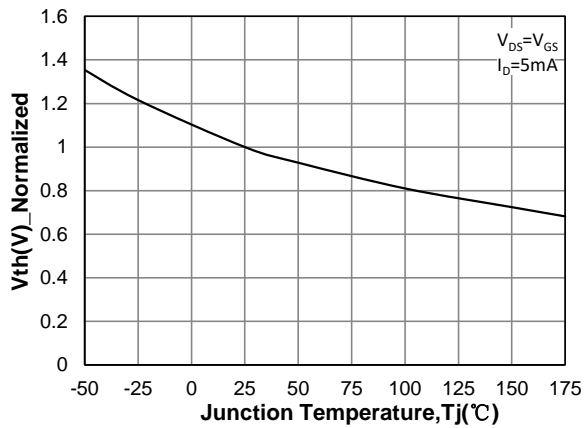

Fig 10: 3rd Quadrant Characteristic at 25°C

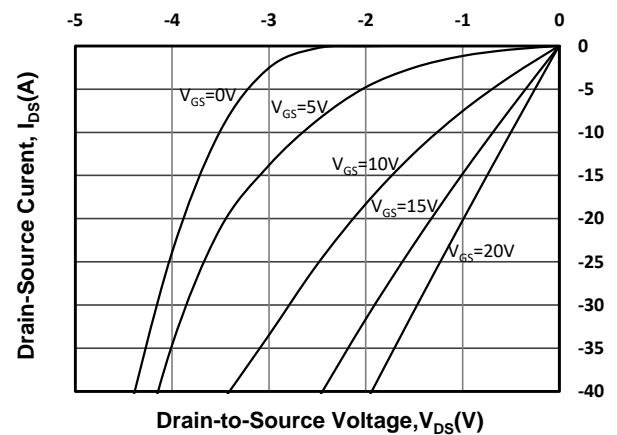

Fig 11: Gate Charge Characteristics

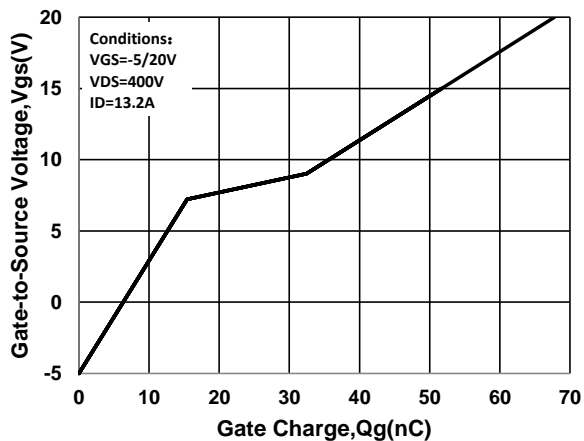

Fig 12: Capacitance Characteristics

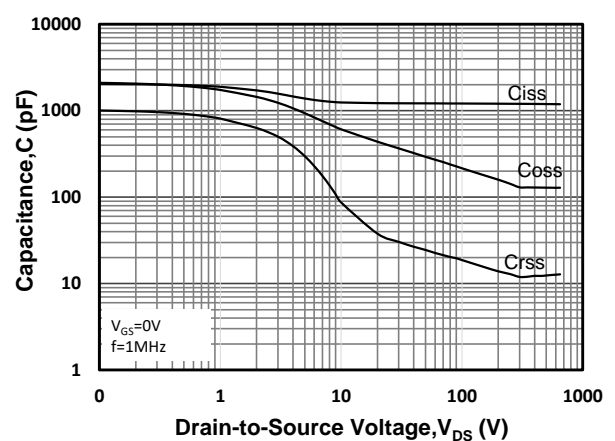

Fig 13: Continuous Drain Current vs. Case Temperature

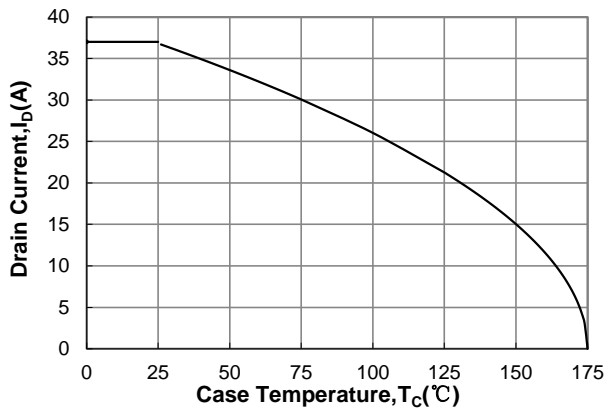

Fig 14: Maximum Power Dissipation vs. Case Temperature

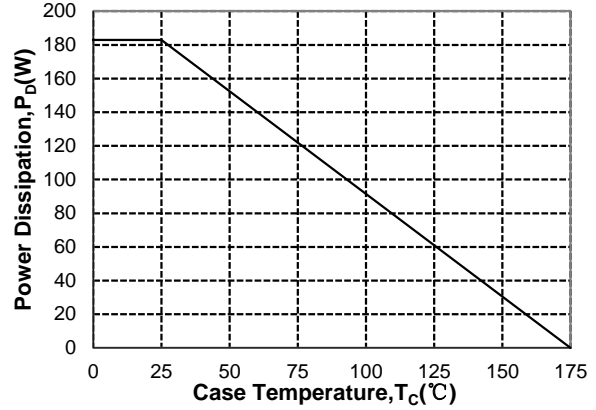

Fig 15: Safe Operating Area

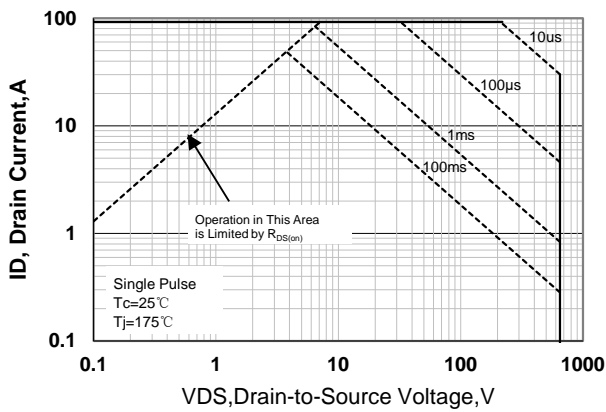

Fig 16: Output Capacitor Stored Energy

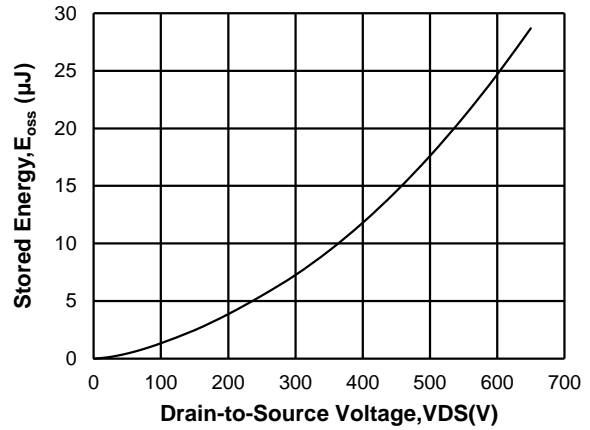
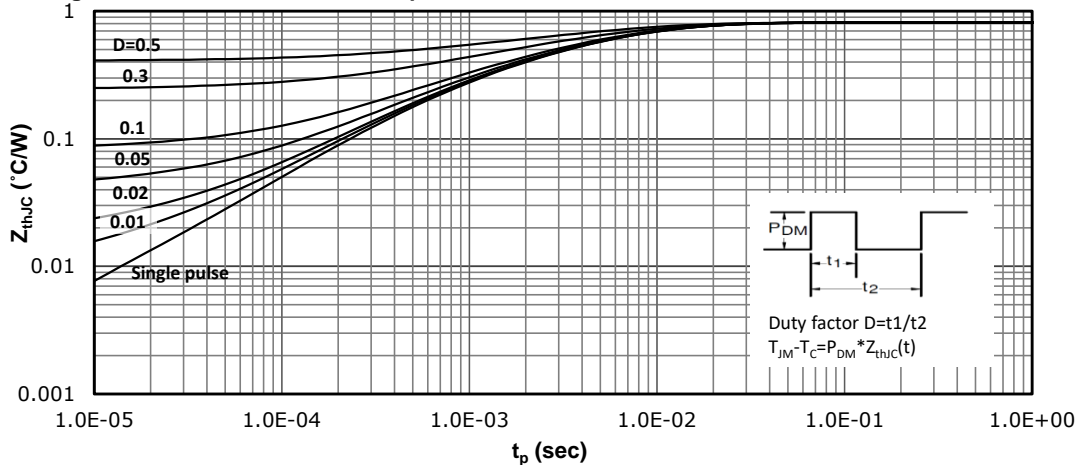
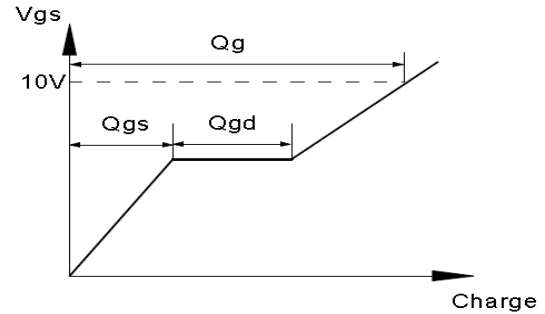
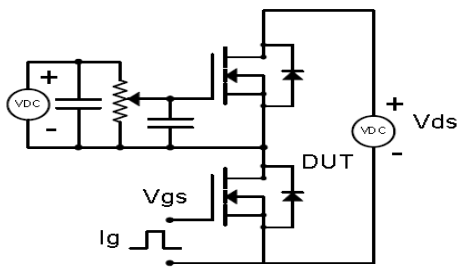

Fig 17: Max. Transient Thermal Impedance



Test Circuit & Waveform

Gate Charge Test Circuit & Waveform



Resistive Switching Test Circuit & Waveforms

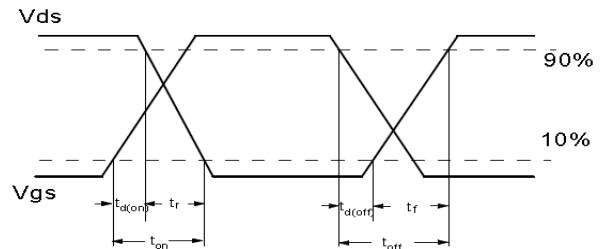
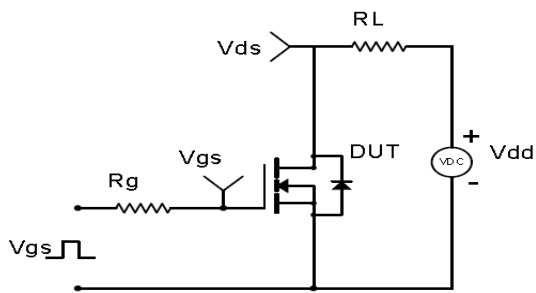

Unclamped Inductive Switching (UIS) Test Circuit & Waveforms

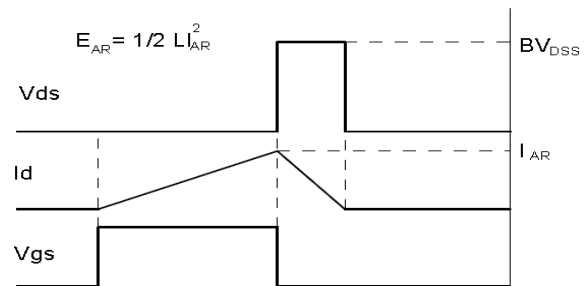
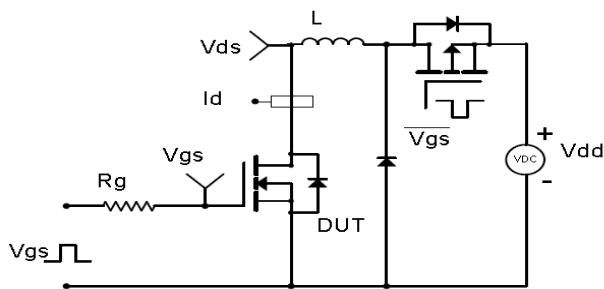

Diode Recovery Test Circuit & Waveforms

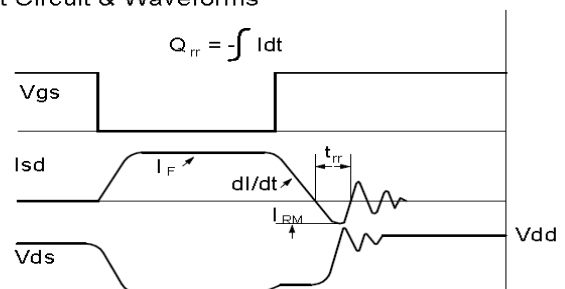
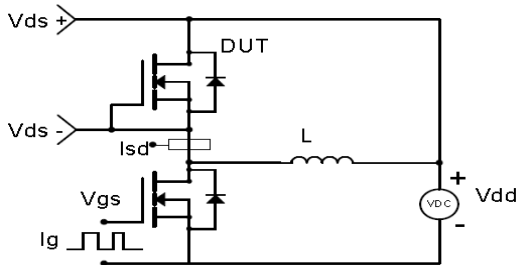

Package Outline: TO-247-4L

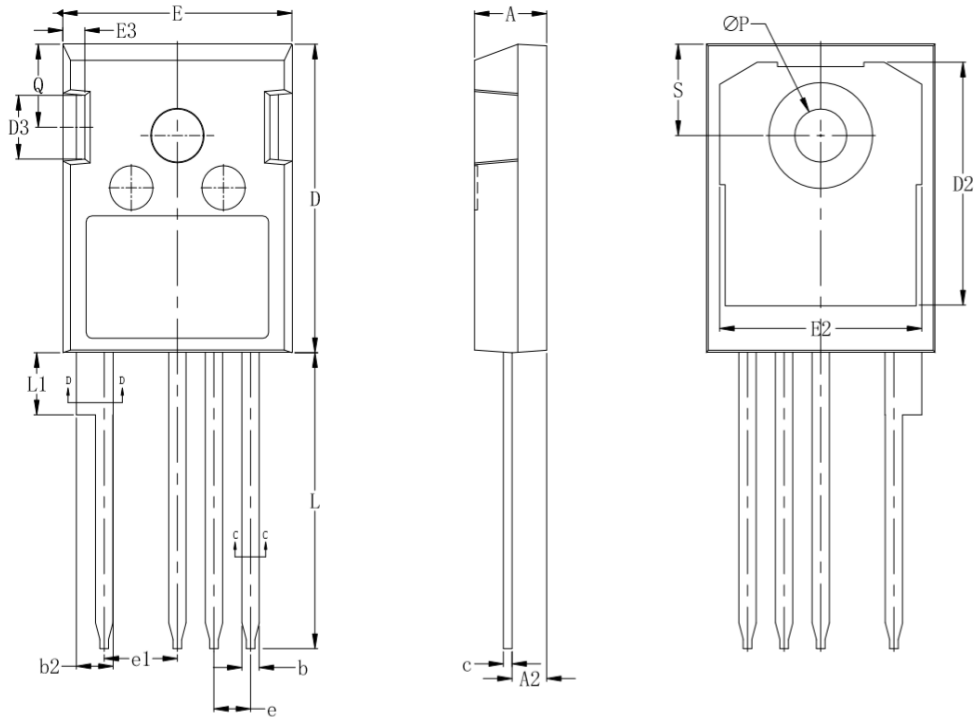

Items	Values(mm)	
	MIN	MAX
A	4.8	5.2
A2	2.2	2.6
b	1.05	1.4
b2	2.4	2.75
c	0.5	0.75
D	20	21.5
D2	15.5	17.2
D3	4	5
E	15.5	16.1
E2	13	15
E3	1	2
e	2.54 BSC.	
e1	5.08 BSC.	
L	19	21
L1	4	4.45
ΦP	3.5	3.7
Q	5.4	5.9
S	5.9	6.4

Revision History

Revision	Date	Major changes
1.0	2022/10/20	Release of formal version
2.0	2022/12/26	Tighten Rdson Spec
3.0	2023/3/2	Update VTH Spec

Disclaimer

Unless otherwise specified in the datasheet, the product is designed and qualified as a standard commercial product and is not intended for use in applications that require extraordinary levels of quality and reliability, such as automotive, aviation/aerospace and life-support devices or systems.

Any and all semiconductor products have certain probability to fail or malfunction, which may result in personal injury, death or property damage. Customer are solely responsible for providing adequate safe measures when design their systems.

CRM reserves the right to improve product design, function and reliability without notice.