



CS100N08 A0

**General Description:**

CS100N08 A0, the silicon N-channel Enhanced VDMOSFETs, is obtained by advanced Trench Technology which reduce the conduction loss, improve switching performance and enhance the avalanche energy. The transistor can be used in various power switching circuit for system miniaturization and higher efficiency. The package form is TO-263, which accords with the RoHS standard.

**Features:**

- **Fast Switching**
- **Low ON Resistance**( $R_{dson} \leq 8.5m\Omega$ )
- **Low Gate Charge** (Typical Data:59.8nC)
- **Low Reverse transfer capacitances**(Typical:237pF)
- **100% Single Pulse avalanche energy Test**

**Applications:**

Power switch circuit of adaptor and charger.

**Absolute** (Tc= 25°C unless otherwise specified):

| Symbol                            | Parameter  | Rating          | Units |
|-----------------------------------|--|-----------------|-------|
| V <sub>DSS</sub>                  | Drain-to-Source Voltage                          | 85              | V     |
| I <sub>D</sub>                    | Continuous Drain Current                         | 100             | A     |
|                                   | Continuous Drain Current T <sub>C</sub> = 100 °C | 65              | A     |
| I <sub>DM</sub> <sup>a1</sup>     | Pulsed Drain Current                             | 400             | A     |
| V <sub>GS</sub>                   | Gate-to-Source Voltage                           | ±20             | V     |
| E <sub>AS</sub> <sup>a2</sup>     | Single Pulse Avalanche Energy                    | 460             | mJ    |
| P <sub>D</sub>                    | Power Dissipation                                | 173             | W     |
|                                   | Derating Factor above 25 °C                      | 1.384           | W/°C  |
| T <sub>J</sub> , T <sub>stg</sub> | Operating Junction and Storage Temperature Range | 150, -55 to 150 | °C    |
| T <sub>L</sub>                    | Maximum Temperature for Soldering                | 300             | °C    |

|  |     |    |
|--|-----|----|
| V <sub>DSS</sub>                         | 85  | V  |
| I <sub>D</sub> (Silicon limited current) | 100 | A  |
| P <sub>D</sub> (T <sub>C</sub> =25°C)    | 173 | W  |
| R <sub>DS(ON)Typ</sub>                   | 6.6 | mΩ |

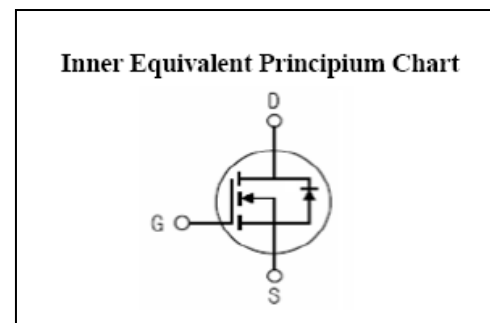
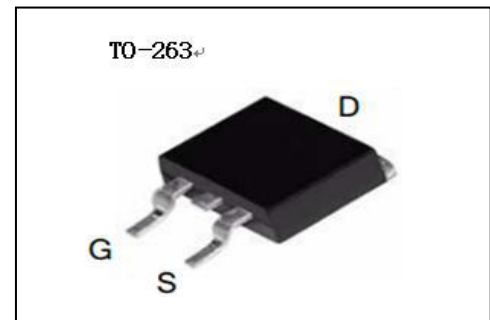

**Electrical Characteristics** (Tc= 25°C unless otherwise specified):

| <b>OFF Characteristics</b> |                                   |   |        |      |      |           |
|----------------------------|-----------------------------------|---|--------|------|------|-----------|
| Symbol                     | Parameter                         | Test Conditions   | Rating |      |      | Unit<br>s |
|                            |                                   |   | Min.   | Typ. | Max. |           |
| V <sub>DSS</sub>           | Drain to Source Breakdown Voltage | V <sub>GS</sub> =0V, I <sub>D</sub> =250μA                          | 85     | --   | --   | V         |
| I <sub>DSS</sub>           | Drain to Source Leakage Current   | V <sub>DS</sub> =85V, V <sub>GS</sub> =0V,<br>T <sub>a</sub> =25°C  | --     | --   | 1    | μA        |
|                            |                                   | V <sub>DS</sub> =68V, V <sub>GS</sub> =0V,<br>T <sub>a</sub> =100°C | --     | --   | 100  | μA        |
| I <sub>GSS(F)</sub>        | Gate to Source Forward Leakage    | V <sub>GS</sub> =+20V   | --     | --   | 100  | nA        |
| I <sub>GSS(R)</sub>        | Gate to Source Reverse Leakage    | V <sub>GS</sub> =-20V   | --     | --   | -100 | nA        |

| <b>ON Characteristics</b>      |                               |  |        |      |      |       |
|--------------------------------|-------------------------------|--|--------|------|------|-------|
| Symbol                         | Parameter                     | Test Conditions  | Rating |      |      | Units |
|                                |                               |  | Min.   | Typ. | Max. |       |
| R <sub>DS(ON)</sub>            | Drain-to-Source On-Resistance | V <sub>GS</sub> =10V, I <sub>D</sub> =50A                  | --     | 6.6  | 8.5  | mΩ    |
| V <sub>GS(TH)</sub>            | Gate Threshold Voltage        | V <sub>DS</sub> = V <sub>GS</sub> , I <sub>D</sub> = 250μA | 2.0    | --   | 4.0  | V     |
| Pulse width tp ≤ 300μs, δ ≤ 2% |                               |  |        |      |      |       |

| <b>Dynamic Characteristics</b> |                              |   |        |      |      |       |
|--------------------------------|------------------------------|---|--------|------|------|-------|
| Symbol                         | Parameter                    | Test Conditions                                       | Rating |      |      | Units |
|                                |                              |   | Min.   | Typ. | Max. |       |
| C <sub>iss</sub>               | Input Capacitance            | V <sub>GS</sub> =0V, V <sub>DS</sub> =25V<br>f=1.0MHz | --     | 3564 | --   | pF    |
| C <sub>oss</sub>               | Output Capacitance           |   | --     | 408  | --   |       |
| C <sub>rss</sub>               | Reverse Transfer Capacitance |   | --     | 237  | --   |       |

| <b>Resistive Switching Characteristics</b> |                                 |   |        |      |      |       |
|--|---------------------------------|---|--------|------|------|-------|
| Symbol                                     | Parameter                       | Test Conditions   | Rating |      |      | Units |
|  |                                 |   | Min.   | Typ. | Max. |       |
| t <sub>d(ON)</sub>                         | Turn-on Delay Time              | V <sub>GS</sub> =10V, R <sub>G</sub> =5Ω<br>V <sub>DD</sub> =40V, I <sub>D</sub> =50A | --     | 32.3 | --   | ns    |
| t <sub>r</sub>                             | Rise Time                       |   | --     | 22.7 | --   |       |
| t <sub>d(OFF)</sub>                        | Turn-Off Delay Time             |   | --     | 55.5 | --   |       |
| t <sub>f</sub>                             | Fall Time                       |   | --     | 13.9 | --   |       |
| Q <sub>g</sub>                             | Total Gate Charge               | V <sub>GS</sub> =10V, V <sub>DD</sub> =64V<br>I <sub>D</sub> =50A                     | --     | 59.8 | --   | nC    |
| Q <sub>gs</sub>                            | Gate to Source Charge           |   | --     | 17.6 | --   |       |
| Q <sub>gd</sub>                            | Gate to Drain ("Miller") Charge |   | --     | 20.8 | --   |       |

| Source-Drain Diode Characteristics                |  |  |        |      |      |       |
|---|--|--|--------|------|------|-------|
| Symbol  | Parameter                              | Test Conditions  | Rating |      |      | Units |
|   |  |  | Min.   | Typ. | Max. |       |
| $I_S$   | Continuous Source Current (Body Diode) |  | --     | --   | 100  | A     |
| $I_{SM}$  | Maximum Pulsed Current (Body Diode)    |  | --     | --   | 400  | A     |
| $V_{SD}$  | Diode Forward Voltage                  | $I_S=50A, V_{GS}=0V$   | --     | --   | 1.2  | V     |
| $t_{rr}$  | Reverse Recovery Time                  | $I_S=50A, T_j = 25^\circ C$<br>$dI_F/dt=100A/us,$<br>$V_{GS}=0V$ | --     | 44   | --   | ns    |
| $Q_{rr}$  | Reverse Recovery Charge                |  | --     | 78.8 | --   | nC    |
| $I_{RRM}$   | Reverse Recovery Current               |  | --     | 3.6  | --   | A     |
| Pulse width $t_p \leq 300 \mu s, \delta \leq 2\%$ |  |  |        |      |      |       |

| Symbol          | Parameter           | Max. | Units        |
|-----------------|---------------------|------|--------------|
| $R_{\theta JC}$ | Junction-to-Case    | 0.72 | $^\circ C/W$ |
| $R_{\theta JA}$ | Junction-to-Ambient | 62.5 | $^\circ C/W$ |

<sup>a1</sup>: Repetitive rating; pulse width limited by maximum junction temperature

<sup>a2</sup>:  $L=0.5mH, I_D=43A, Start T_j=25^\circ C$

Characteristics Curve:

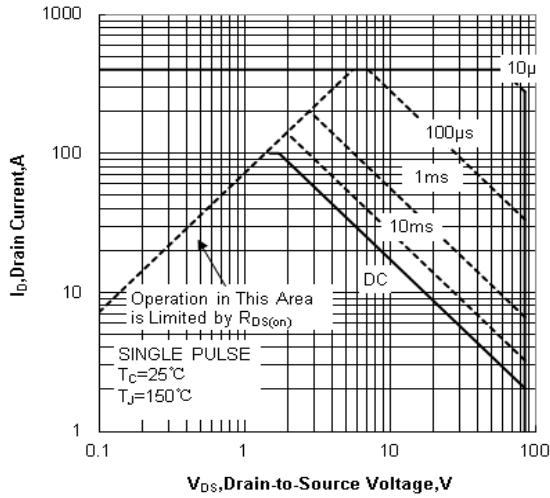

Figure 1 Maximum Forward Bias Safe Operating Area

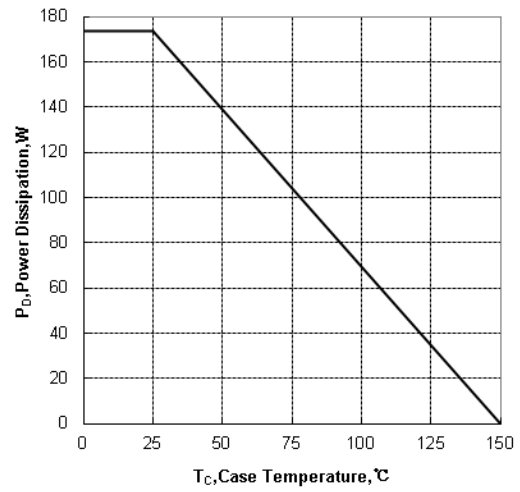

Figure 2 Maximum Power Dissipation vs Case Temperature

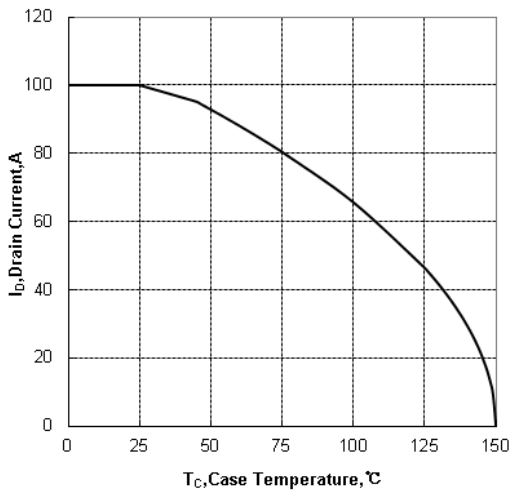

Figure 3 Maximum Continuous Drain Current vs Case Temperature

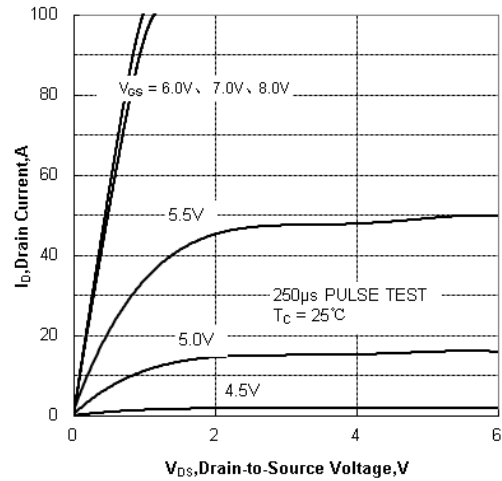

Figure 4 Typical Output Characteristics

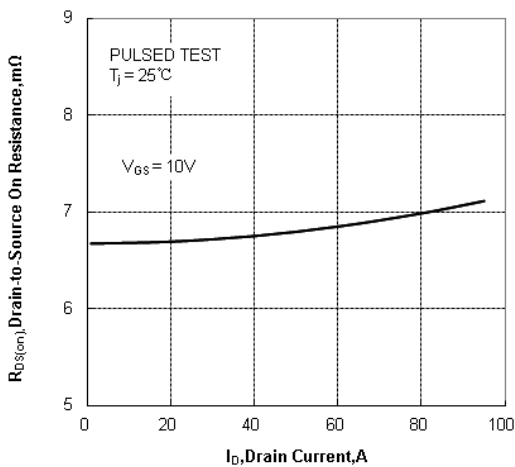

Figure 5 Drain-to-Source On Resistance vs Drain Current

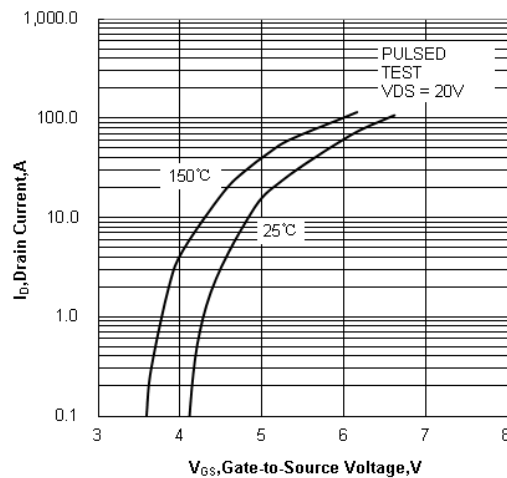

Figure 6 Typical Transfer Characteristics

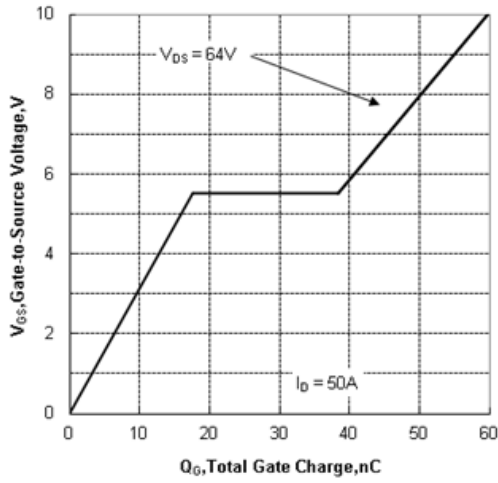

Figure 7 Typical Gate Charge vs Gate to Source Voltage

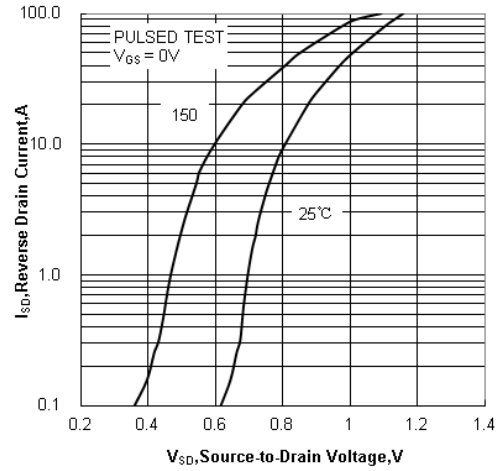

Figure 8 Typical Body Diode Transfer Characteristics

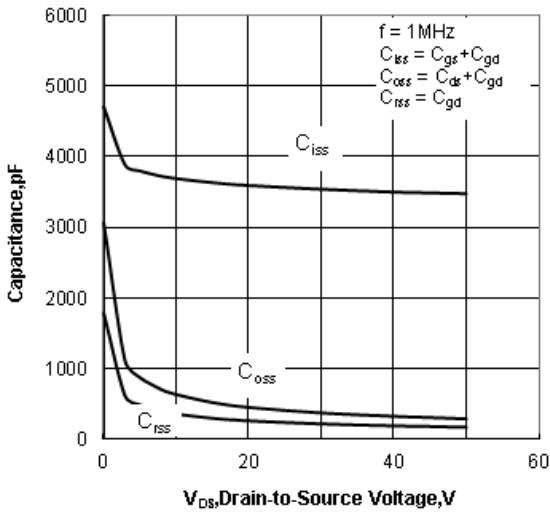

Figure 9 Typical Capacitance vs Drain to Source Voltage

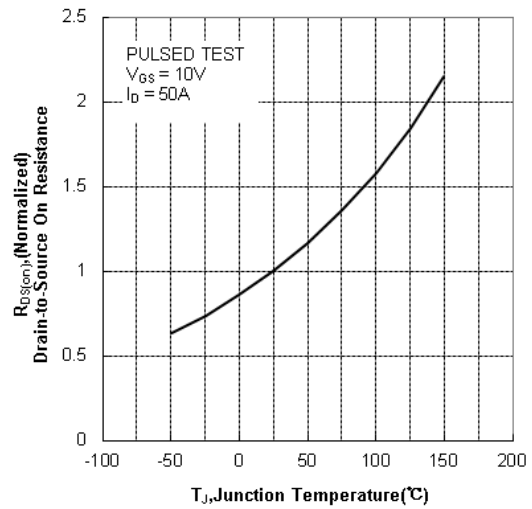

Figure 10 Typical Drain to Source on Resistance vs Junction Temperature

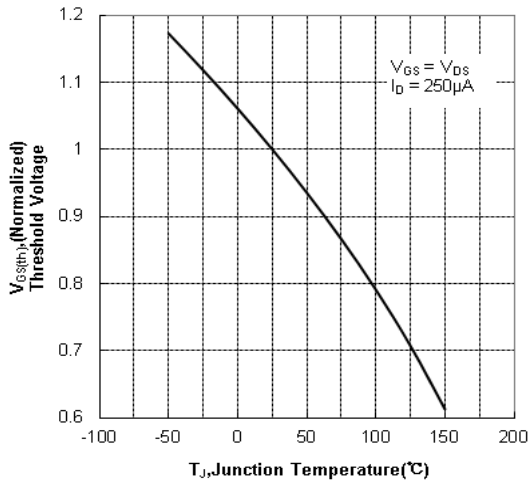

Figure 11 Typical Theshold Voltage vs Junction Temperature

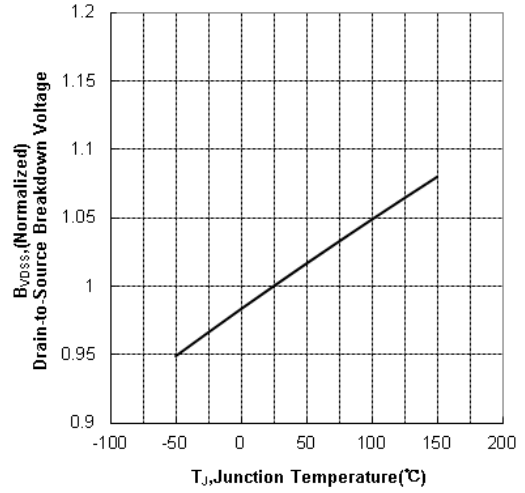

Figure 12 Typical Breakdown Voltage vs Junction Temperature

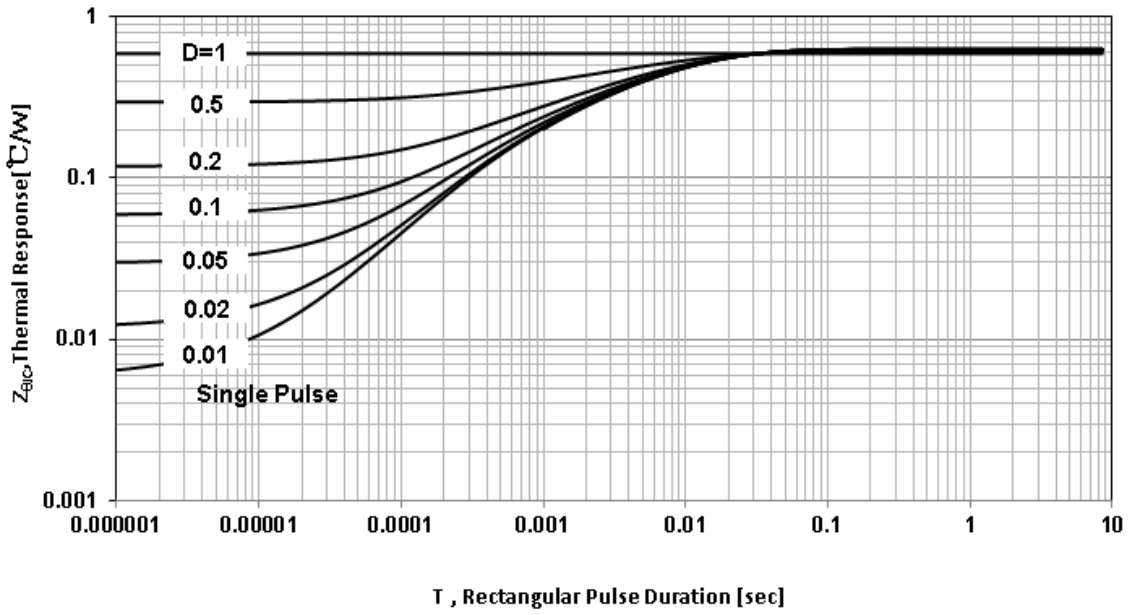

Figure 13 Maximum Effective Transient Thermal Impedance, Junction-to-Case

Test Circuit and Waveform



Figure 17. Gate Charge Test Circuit

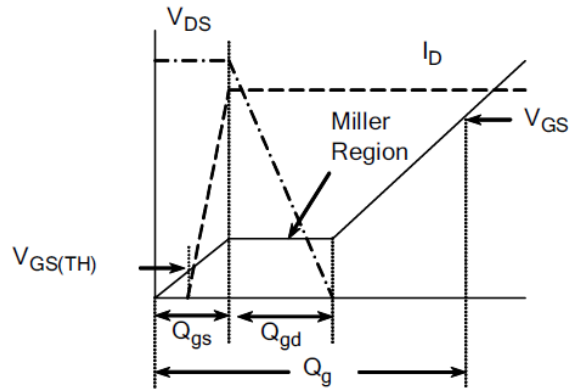

Figure 18. Gate Charge Waveform



Figure 19. Resistive Switching Test Circuit

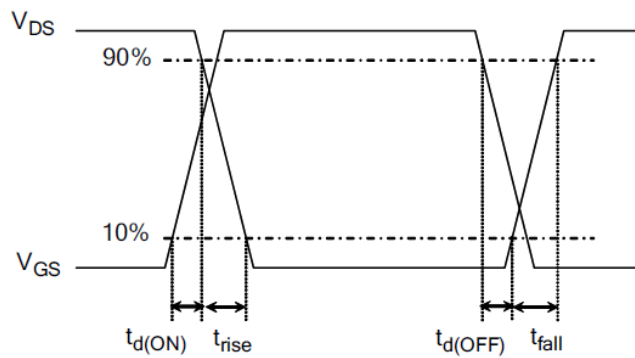

Figure 20. Resistive Switching Waveforms

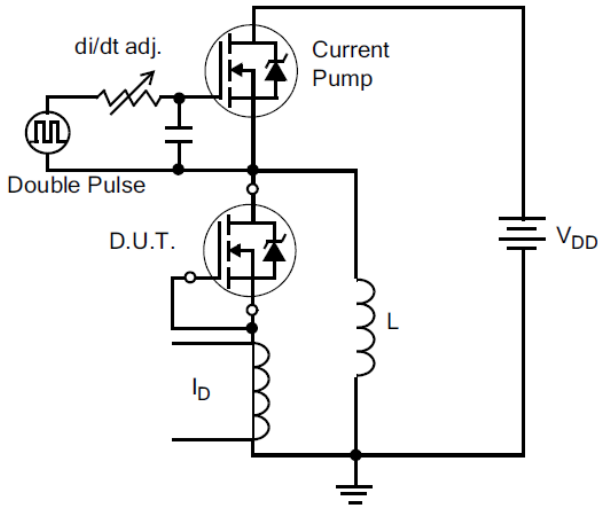

Figure 21. Diode Reverse Recovery Test Circuit

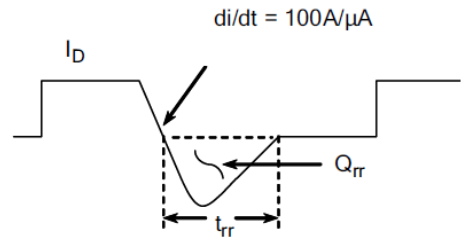

Figure 22. Diode Reverse Recovery Waveform

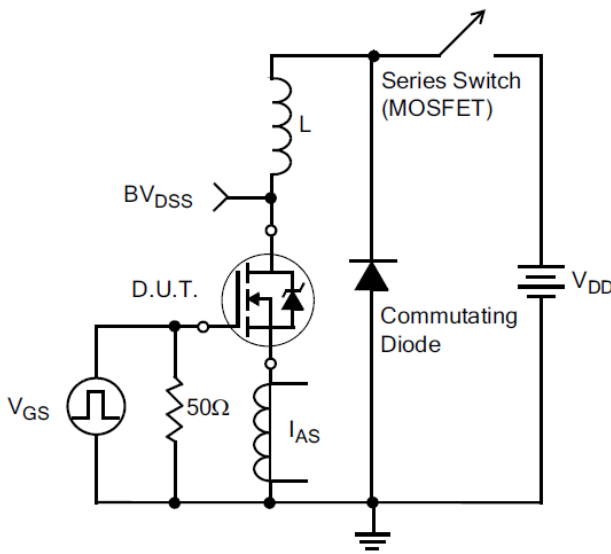

Figure 23. Unclamped Inductive Switching Test Circuit

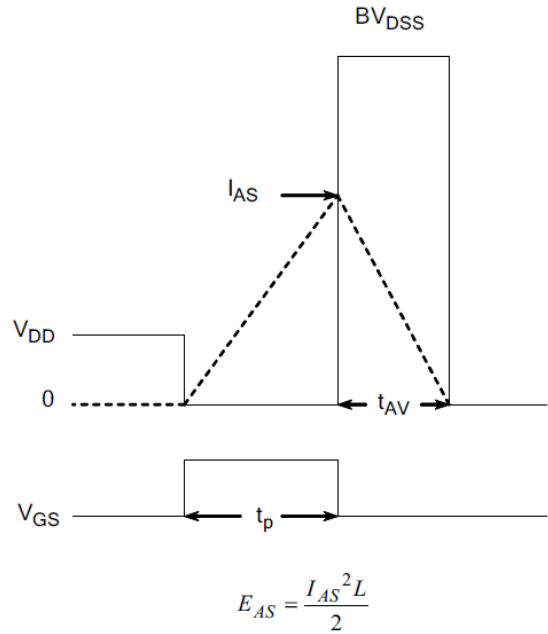
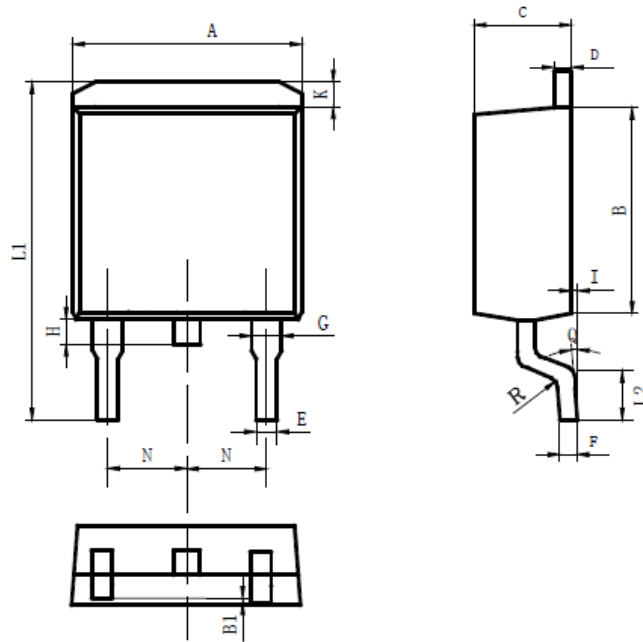

Figure 24. Unclamped Inductive Switching Waveforms



**Package Information:**



| Items | Values(mm) |       |
|-------|------------|-------|
|       | MIN        | MAX   |
| A     | 9.80       | 10.40 |
| B     | 8.90       | 9.50  |
| B1    | 0          | 0.10  |
| C     | 4.40       | 4.80  |
| D     | 1.16       | 1.37  |
| E     | 0.70       | 0.95  |
| F     | 0.30       | 0.60  |
| G     | 1.07       | 1.47  |
| H     | 1.30       | 1.80  |
| K     | 0.95       | 1.37  |
| L1    | 14.50      | 16.50 |
| L2    | 1.60       | 2.30  |
| I     | 0          | 0.2   |
| Q     | 0°         | 8°    |
| R     | 0.4        |       |
| N     | 2.39       | 2.69  |

TO-263 Package



The name and content of poisonous and harmful material in products

|              | Hazardous Substance  |       |            |         |       |       |       |       |       |       |
|--------------|--|-------|------------|---------|-------|-------|-------|-------|-------|-------|
|              | Pb   | Hg    | Cd         | Cr (VI) | PBB   | PBDE  | DIBP  | DEHP  | DBP   | BBP   |
| Limit        | ≤0.1%  | ≤0.1% | ≤<br>0.01% | ≤0.1%   | ≤0.1% | ≤0.1% | ≤0.1% | ≤0.1% | ≤0.1% | ≤0.1% |
| Lead Frame   | ○  | ○     | ○          | ○       | ○     | ○     | ○     | ○     | ○     | ○     |
| Molding      | ○  | ○     | ○          | ○       | ○     | ○     | ○     | ○     | ○     | ○     |
| Chip         | ○  | ○     | ○          | ○       | ○     | ○     | ○     | ○     | ○     | ○     |
| Wire Bonding | ○  | ○     | ○          | ○       | ○     | ○     | ○     | ○     | ○     | ○     |
| Solder       | ×  | ○     | ○          | ○       | ○     | ○     | ○     | ○     | ○     | ○     |
| Note         | <p>○: Means the hazardous material is under the criterion of 2011/65/EU.<br/>         ×: Means the hazardous material exceeds the criterion of 2011/65/EU.<br/>         The plumbum element of solder exist in products presently, but within the allowed range of Eurogroup's RoHS.</p> |       |            |         |       |       |       |       |       |       |

Warnings

1. Exceeding the maximum ratings of the device in performance may cause damage to the device, even the permanent failure, which may affect the dependability of the machine. It is suggested to be used under 80 percent of the maximum ratings of the device.
2. When installing the heatsink, please pay attention to the torsional moment and the smoothness of the heatsink.
3. VDMOSFETs is the device which is sensitive to the static electricity, it is necessary to protect the device from being damaged by the static electricity when using it.
4. This publication is made by Huajing Microelectronics and subject to regular change without notice.

WUXI CHINA RESOURCES HUAJING MICROELECTRONICS CO., LTD.

Add: No.14 Liangxi RD. Wuxi, Jiangsu, China Mail:214061 <http://www.crhj.com.cn>  
Tel: +86 0510-85807228 Fax: +86- 0510-85800864

Marketing Part: Post: 214061 Tel: +86 0510-81805277/81805336  
Fax: +86 0510-85800360/85803016  
E-mail: sales@hj.crmicro.com

Application and Service: Post: 214061 Tel/ Fax: +86- 0510-81805243/81805110