



## CS2N60 A4H

**General Description:**

CS2N60 A4H, the silicon N-channel Enhanced VDMOSFETs, is obtained by the self-aligned planar Technology which reduce the conduction loss, improve switching performance and enhance the avalanche energy. The transistor can be used in various power switching circuit for system miniaturization and higher efficiency. The package form is TO-252, which accords with the RoHS standard..

**Features:**

- I **Fast Switching**
- I **Low ON Resistance**( $R_{dson} \leq 4.5\Omega$ )
- I **Low Gate Charge** (Typical Data:8.5nC)
- I **Low Reverse transfer capacitances**(Typical:5.4pF)
- I **100% Single Pulse avalanche energy Test**

**Applications:**

Power switch circuit of adaptor and charger.

**Absolute** ( $T_c = 25^\circ\text{C}$  unless otherwise specified):

|                              |     |          |
|------------------------------|-----|----------|
| $V_{DSS}$                    | 600 | V        |
| $I_D$                        | 2   | A        |
| $P_D (T_C=25^\circ\text{C})$ | 35  | W        |
| $R_{DS(ON)Typ}$              | 3.6 | $\Omega$ |

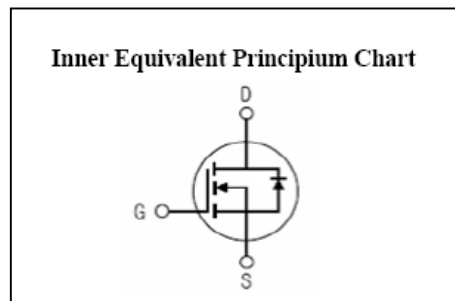
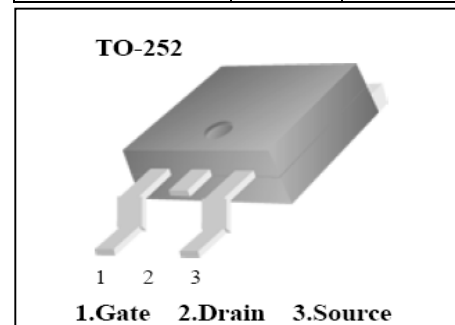

| Symbol         | Parameter  | Rating            | Units               |
|----------------|--|-------------------|---------------------|
| $V_{DSS}$      | Drain-to-Source Voltage                            | 600               | V                   |
| $I_D$          | Continuous Drain Current                           | 2.0               | A                   |
|                | Continuous Drain Current $T_C = 100^\circ\text{C}$ | 1.45              | A                   |
| $I_{DM}^{a1}$  | Pulsed Drain Current                               | 8.0               | A                   |
| $V_{GS}$       | Gate-to-Source Voltage                             | $\pm 30$          | V                   |
| $E_{AS}^{a2}$  | Single Pulse Avalanche Energy                      | 80                | mJ                  |
| $E_{AR}^{a1}$  | Avalanche Energy ,Repetitive                       | 6.4               | mJ                  |
| $I_{AR}^{a1}$  | Avalanche Current                                  | 1.1               | A                   |
| $dv/dt^{a3}$   | Peak Diode Recovery dv/dt                          | 5                 | V/ns                |
| $P_D$          | Power Dissipation                                  | 35                | W                   |
|                | Derating Factor above $25^\circ\text{C}$           | 0.28              | W/ $^\circ\text{C}$ |
| $T_J, T_{stg}$ | Operating Junction and Storage Temperature Range   | 150, $-55$ to 150 | $^\circ\text{C}$    |
| $T_L$          | Maximum Temperature for Soldering                  | 300               | $^\circ\text{C}$    |

**Electrical Characteristics** (Tc= 25°C unless otherwise specified):

| <b>OFF Characteristics</b>          |                                   |  |        |      |      |       |
|-------------------------------------|-----------------------------------|--|--------|------|------|-------|
| Symbol                              | Parameter                         | Test Conditions  | Rating |      |      | Units |
|                                     |                                   |  | Min.   | Typ. | Max. |       |
| V <sub>DSS</sub>                    | Drain to Source Breakdown Voltage | V <sub>GS</sub> =0V, I <sub>D</sub> =250μA                             | 600    | --   | --   | V     |
| ΔBV <sub>DSS</sub> /ΔT <sub>J</sub> | Bvdss Temperature Coefficient     | I <sub>D</sub> =250uA, Reference 25°C                                  | --     | 0.6  | --   | V/°C  |
| I <sub>DSS</sub>                    | Drain to Source Leakage Current   | V <sub>DS</sub> = 600V, V <sub>GS</sub> = 0V,<br>T <sub>a</sub> = 25°C | --     | --   | 1    | μA    |
|                                     |                                   | V <sub>DS</sub> =480V, V <sub>GS</sub> = 0V,<br>T <sub>a</sub> = 125°C |        |      | 100  |       |
| I <sub>GSS(F)</sub>                 | Gate to Source Forward Leakage    | V <sub>GS</sub> = 30V  | --     | --   | 100  | nA    |
| I <sub>GSS(R)</sub>                 | Gate to Source Reverse Leakage    | V <sub>GS</sub> =-30V  | --     | --   | -100 | nA    |

| <b>ON Characteristics</b>  |                               |  |        |      |      |       |
|----------------------------|-------------------------------|--|--------|------|------|-------|
| Symbol                     | Parameter                     | Test Conditions  | Rating |      |      | Units |
|                            |                               |  | Min.   | Typ. | Max. |       |
| R <sub>DS(ON)</sub>        | Drain-to-Source On-Resistance | V <sub>GS</sub> =10V, I <sub>D</sub> =1.0A                 | --     | 3.6  | 4.5  | Ω     |
| V <sub>GS(TH)</sub>        | Gate Threshold Voltage        | V <sub>DS</sub> = V <sub>GS</sub> , I <sub>D</sub> = 250μA | 2.0    |      | 4.0  | V     |
| Pulse width tp≤300μs, δ≤2% |                               |  |        |      |      |       |

| <b>Dynamic Characteristics</b> |                              |  |        |      |      |       |
|--------------------------------|------------------------------|--|--------|------|------|-------|
| Symbol                         | Parameter                    | Test Conditions  | Rating |      |      | Units |
|                                |                              |  | Min.   | Typ. | Max. |       |
| g <sub>fs</sub>                | Forward Trans conductance    | V <sub>DS</sub> =15V, I <sub>D</sub> =1.0A               |        | 1.8  | --   | S     |
| C <sub>iss</sub>               | Input Capacitance            | V <sub>GS</sub> = 0V V <sub>DS</sub> = 25V<br>f = 1.0MHz | --     | 280  |      | pF    |
| C <sub>oss</sub>               | Output Capacitance           |  | --     | 31   |      |       |
| C <sub>rss</sub>               | Reverse Transfer Capacitance |  | --     | 5.4  |      |       |

| <b>Resistive Switching Characteristics</b> |                                |   |        |      |      |       |
|--|--------------------------------|---|--------|------|------|-------|
| Symbol                                     | Parameter                      | Test Conditions   | Rating |      |      | Units |
|  |                                |   | Min.   | Typ. | Max. |       |
| t <sub>d(ON)</sub>                         | Turn-on Delay Time             | I <sub>D</sub> =2.0A V <sub>DD</sub> = 300V<br>V <sub>GS</sub> = 10V R <sub>G</sub> =9.1Ω | --     | 7    | --   | ns    |
| t <sub>r</sub>                             | Rise Time                      |   | --     | 5    | --   |       |
| t <sub>d(OFF)</sub>                        | Turn-Off Delay Time            |   | --     | 26   | --   |       |
| t <sub>f</sub>                             | Fall Time                      |   | --     | 10.5 | --   |       |
| Q <sub>g</sub>                             | Total Gate Charge              | I <sub>D</sub> =2.0A V <sub>DD</sub> =300V<br>V <sub>GS</sub> = 10V                       | --     | 8.5  |      | nC    |
| Q <sub>gs</sub>                            | Gate to Source Charge          |   | --     | 1.5  |      |       |
| Q <sub>gd</sub>                            | Gate to Drain (“Miller”)Charge |   | --     | 4.0  |      |       |

| Source-Drain Diode Characteristics               |  |                              |        |      |      |       |
|--|--|------------------------------|--------|------|------|-------|
| Symbol   | Parameter                              | Test Conditions              | Rating |      |      | Units |
|  |  |                              | Min.   | Typ. | Max. |       |
| $I_S$  | Continuous Source Current (Body Diode) |                              | --     | --   | 2    | A     |
| $I_{SM}$   | Maximum Pulsed Current (Body Diode)    |                              | --     | --   | 8    | A     |
| $V_{SD}$   | Diode Forward Voltage                  | $I_S=2.0A, V_{GS}=0V$        | --     | --   | 1.5  | V     |
| $t_{rr}$   | Reverse Recovery Time                  | $I_S=2.0A, T_j = 25^\circ C$ | --     | 407  | --   | ns    |
| $Q_{rr}$   | Reverse Recovery Charge                | $dI_F/dt=100A/us, V_{GS}=0V$ | --     | 1152 | --   | nC    |
| Pulse width $t_p \leq 300\mu s, \delta \leq 2\%$ |  |                              |        |      |      |       |

| Symbol          | Parameter           | Typ. | Units        |
|-----------------|---------------------|------|--------------|
| $R_{\theta JC}$ | Junction-to-Case    | 3.57 | $^\circ C/W$ |
| $R_{\theta JA}$ | Junction-to-Ambient | 62   | $^\circ C/W$ |

<sup>a1</sup>: Repetitive rating; pulse width limited by maximum junction temperature

<sup>a2</sup>:  $L=10.0mH, I_D=4A, \text{Start } T_j=25^\circ C$

<sup>a3</sup>:  $I_{SD}=2A, di/dt \leq 100A/us, V_{DD} \leq BV_{DS}, \text{Start } T_j=25^\circ C$

Characteristics Curve:

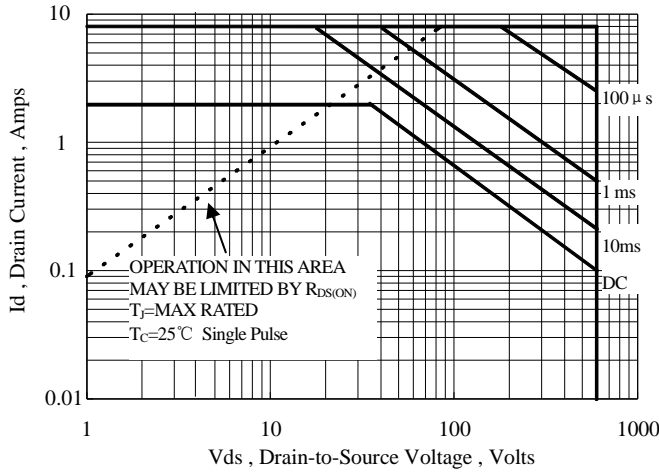

Figure 1 Maximum Forward Bias Safe Operating Area

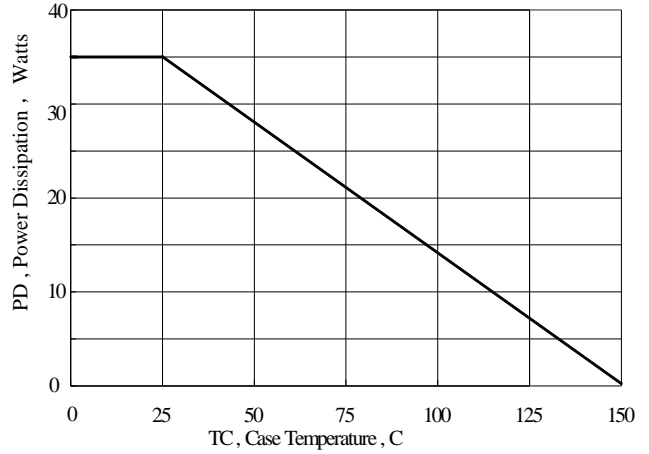

Figure 2 Maximum Power Dissipation vs Case Temperature

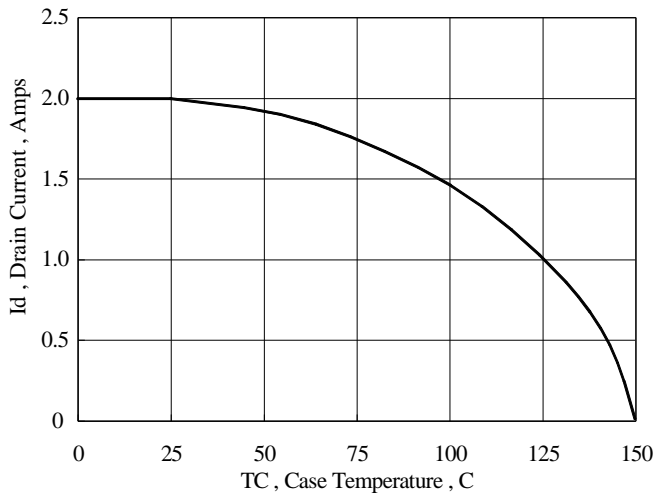

Figure 3 Maximum Continuous Drain Current vs Case Temperature

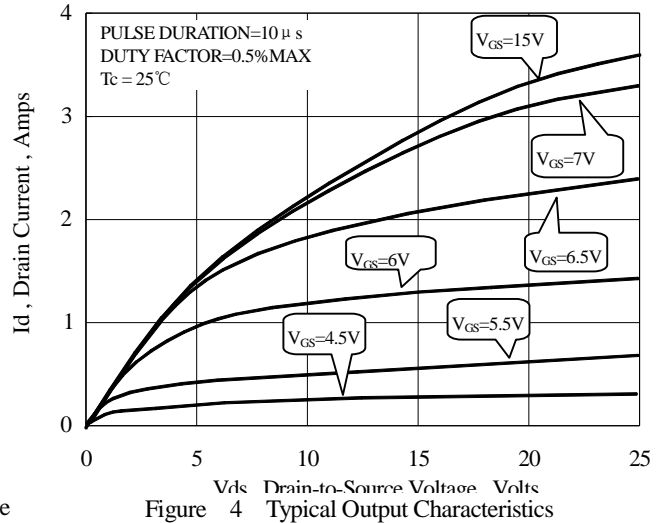

Figure 4 Typical Output Characteristics

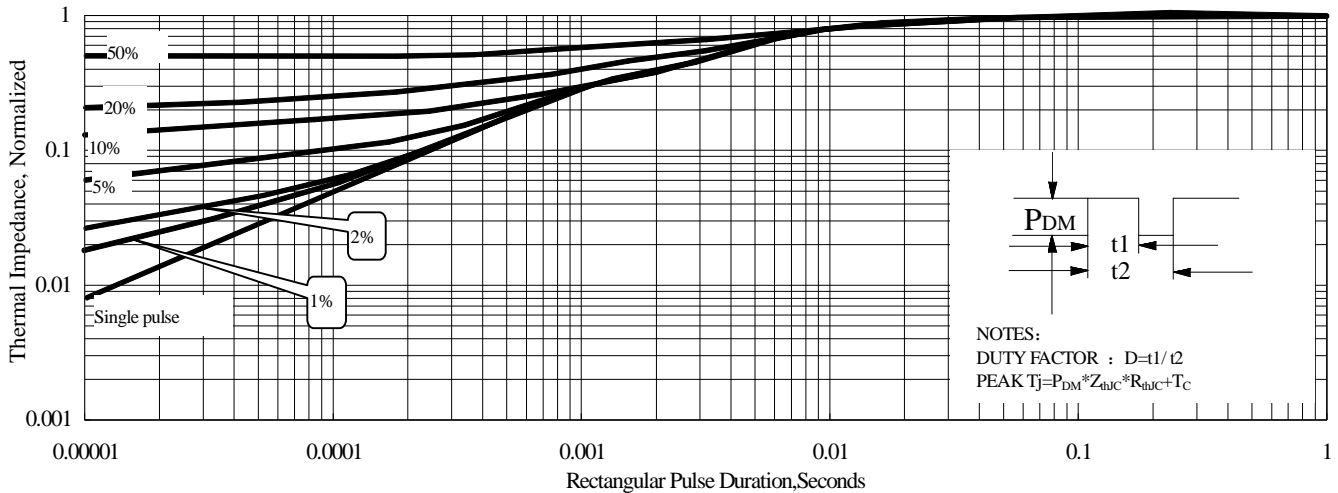

Figure 5 Maximum Effective Thermal Impedance, Junction to Case

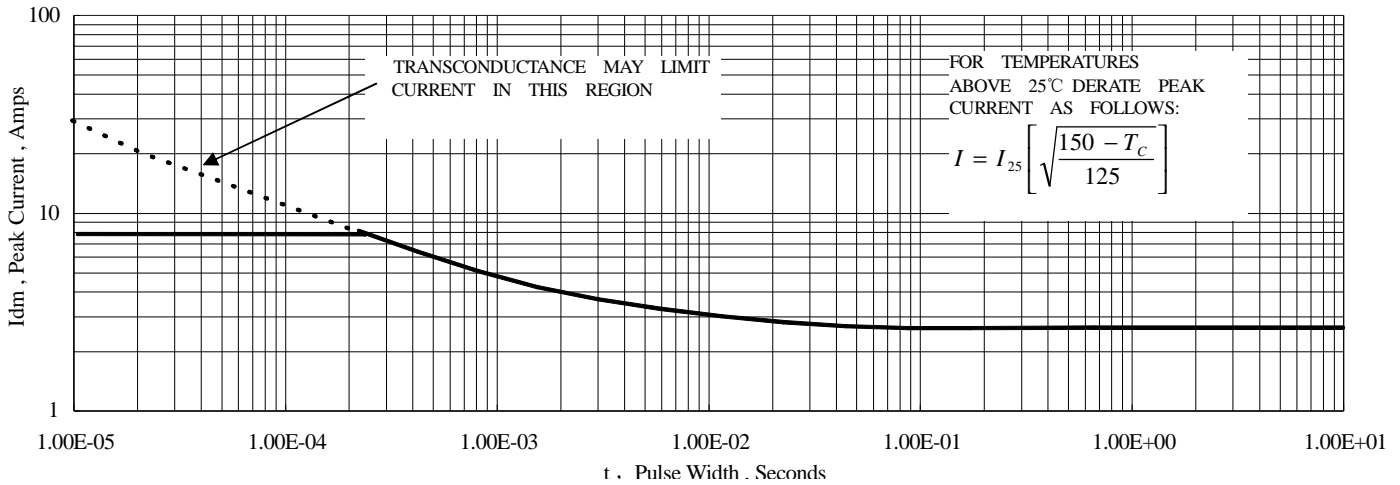

Figure 6 Maximum Peak Current Capability

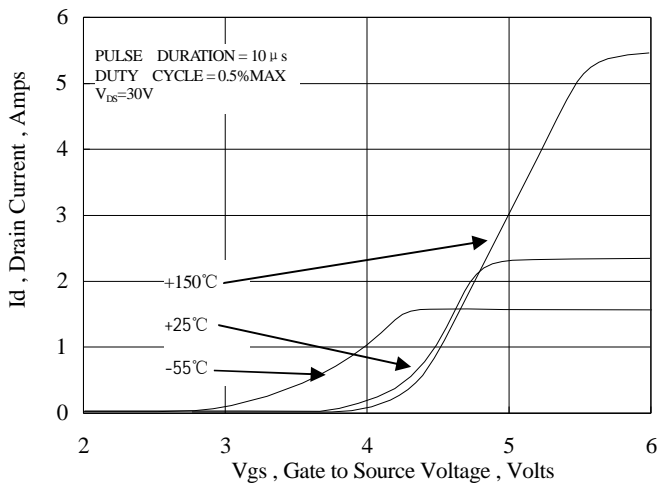

Figure 7 Typical Transfer Characteristics

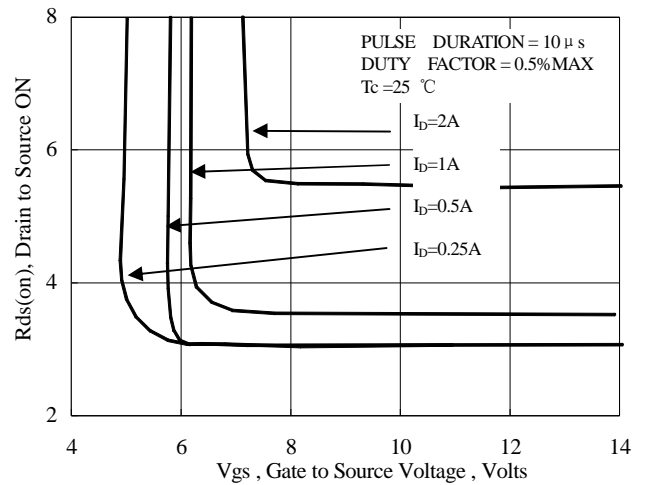

Figure 8 Typical Drain to Source ON Resistance vs Gate Voltage and Drain Current

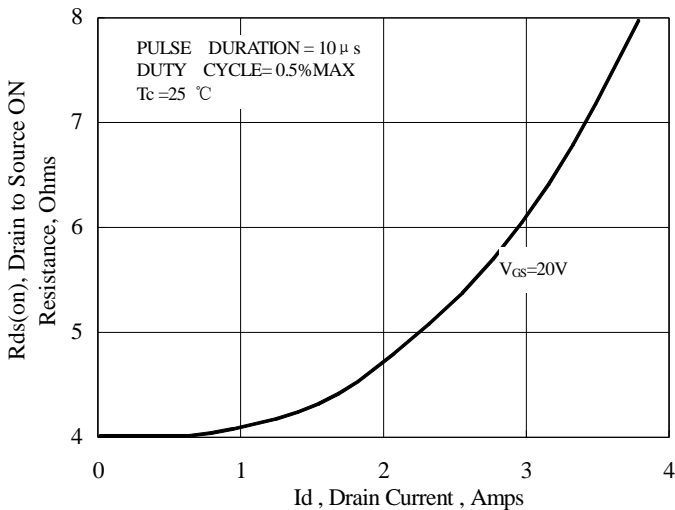

Figure 9 Typical Drain to Source ON Resistance vs Drain Current

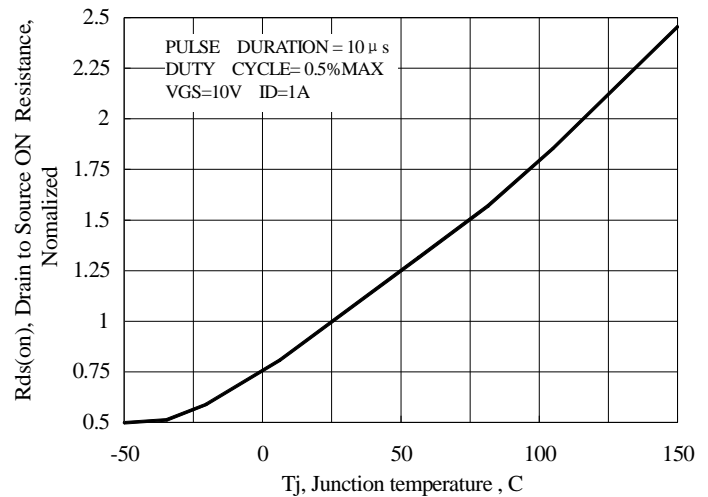

Figure 10 Typical Drain to Source on Resistance vs Junction Temperature

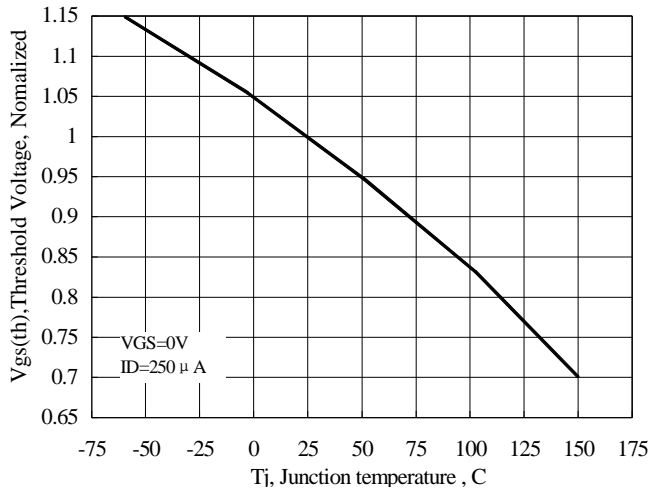

Figure 11 Typical Theshold Voltage vs Junction Temperature

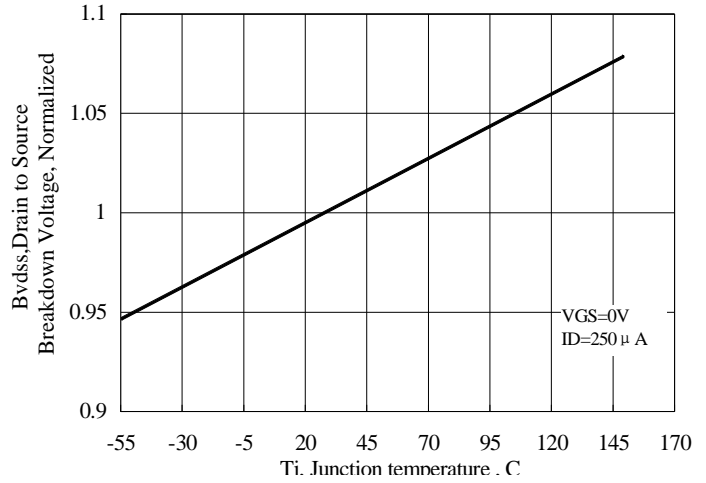

Figure 12 Typical Breakdown Voltage vs Junction Temperature

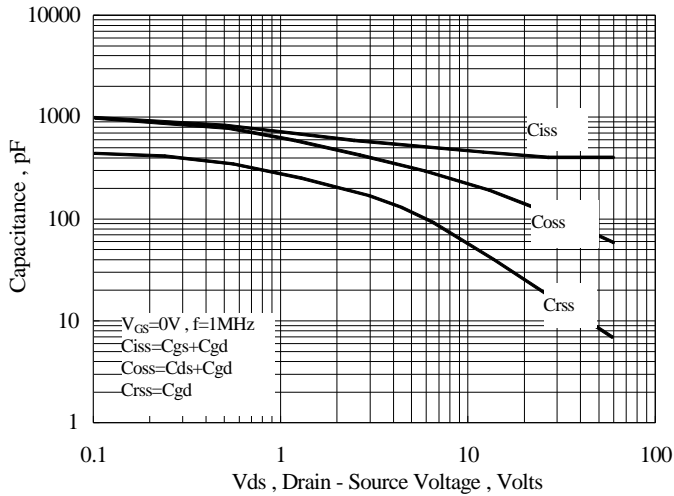

Figure 13 Typical Capacitance vs Drain to Source Voltage

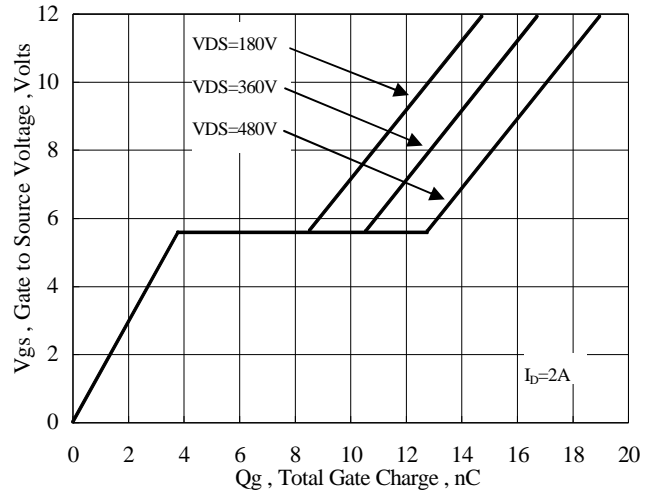

Figure 14 Typical Gate Charge vs Gate to Source Voltage

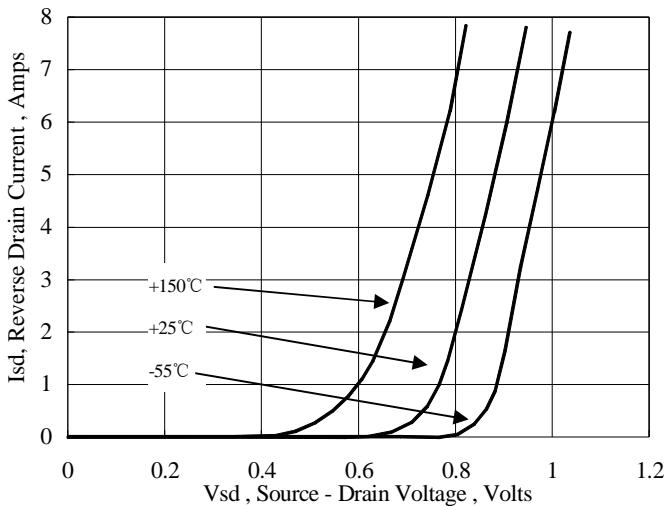

Figure 15 Typical Body Diode Transfer Characteristics

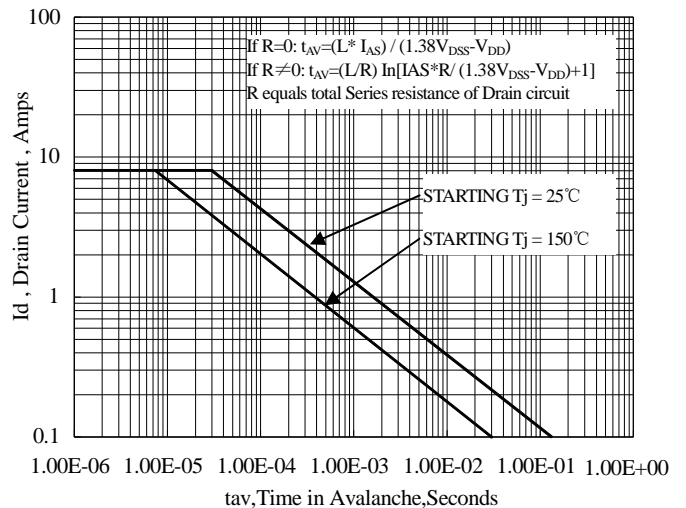

Figure 16 Unclamped Inductive Switching Capability

Test Circuit and Waveform



Figure 17. Gate Charge Test Circuit



Figure 18. Gate Charge Waveform



Figure 19. Resistive Switching Test Circuit



Figure 20. Resistive Switching Waveforms



Figure 21. Diode Reverse Recovery Test Circuit



Figure 22. Diode Reverse Recovery Waveform



Figure 23. Unclamped Inductive Switching Test Circuit



Figure 24. Unclamped Inductive Switching Waveforms



**Package Information:**

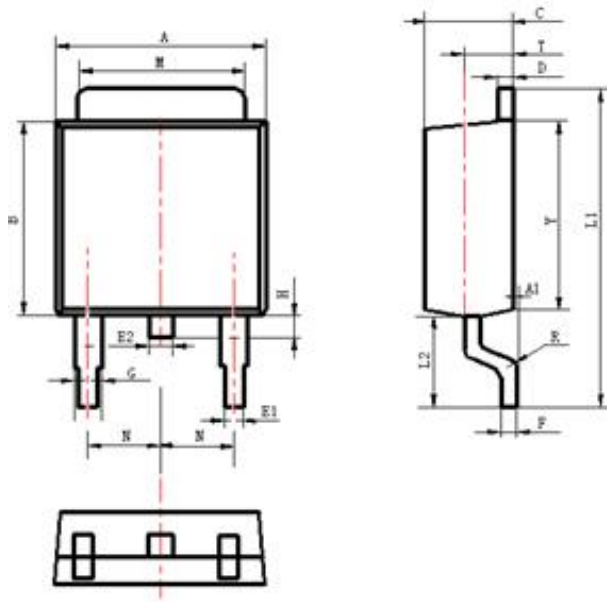

| Items | Values(mm) |       |
|-------|------------|-------|
|       | MIN        | MAX   |
| A     | 6.30       | 6.90  |
| A1    | 0          | 0.13  |
| B     | 5.70       | 6.30  |
| C     | 2.10       | 2.50  |
| D     | 0.30       | 0.60  |
| E1    | 0.60       | 0.90  |
| E2    | 0.70       | 1.00  |
| F     | 0.30       | 0.60  |
| G     | 0.70       | 1.00  |
| L1    | 9.60       | 10.30 |
| L2    | 2.70       | 3.10  |
| H     | 0.60       | 1.00  |
| M     | 5.10       | 5.50  |
| N     | 2.09       | 2.49  |
| R     | 0.3        |       |
| T     | 1.40       | 1.60  |
| Y     | 5.10       | 6.30  |

TO-252 Package

**The name and content of poisonous and harmful material in products**

| Part's Name      | Hazardous Substance   |       |        |        |       |       |
|------------------|---|-------|--------|--------|-------|-------|
|                  | Pb  | Hg    | Cd     | Cr(VI) | PBB   | PBDE  |
| Limit            | ≤0.1%   | ≤0.1% | ≤0.01% | ≤0.1%  | ≤0.1% | ≤0.1% |
| Lead Frame       | ○   | ○     | ○      | ○      | ○     | ○     |
| Molding Compound | ○   | ○     | ○      | ○      | ○     | ○     |
| Chip             | ○   | ○     | ○      | ○      | ○     | ○     |
| Wire Bonding     | ○   | ○     | ○      | ○      | ○     | ○     |
| Solder           | ×   | ○     | ○      | ○      | ○     | ○     |
| Note             | ○: means the hazardous material is under the criterion of SJ/T11363-2006.<br>×: means the hazardous material exceeds the criterion of SJ/T11363-2006.<br>The plumbum element of solder exist in products presently, but within the allowed range of Eurogroup's RoHS. |       |        |        |       |       |

**Warnings**

1. Exceeding the maximum ratings of the device in performance may cause damage to the device, even the permanent failure, which may affect the dependability of the machine. It is suggested to be used under 80 percent of the maximum ratings of the device.
2. When installing the heatsink, please pay attention to the torsional moment and the smoothness of the heatsink.
3. VDMOSFETs is the device which is sensitive to the static electricity, it is necessary to protect the device from being damaged by the static electricity when using it.
4. This publication is made by Huajing Microelectronics and subject to regular change without notice.

**WUXI CHINA RESOURCES HUAJING MICROELECTRONICS CO., LTD.**

Add: No.14 Liangxi RD. Wuxi, Jiangsu, China Mail:214061 <http://www.crhj.com.cn>  
Tel: +86 0510-85807228 Fax: +86- 0510-85800864

Marketing Part: Post: 214061 Tel: +86 0510-81805277/81805336  
Fax: +86 0510-85800360/85803016  
E-mail: [sales@hj.crmicro.com](mailto:sales@hj.crmicro.com)

Application and Service: Post: 214061 Tel / Fax: +86- 0510-81805243/81805110