



## CS55N10 A8-G

### General Description:

CS55N10 A8-G, the silicon N-channel Enhanced VDMOSFETs, is obtained by the high density Trench technology which reduce the conduction loss, improve switching performance and enhance the avalanche energy. This device is suitable for use as a load switch and PWM applications. The package form is TO-220, which accords with the RoHS standard.

### Features:

- | **Fast Switching**
- | **Low ON Resistance**( $R_{ds(on)} \leq 15 \text{ m}\Omega$ )
- | **Low Gate Charge**
- | **Low Reverse transfer capacitances**
- | **100% Single Pulse avalanche energy Test**
- | **Halogen Free**

### Applications:

Power switch circuit of adaptor and charger.

$V_{DSS}$	100	V
$I_D$ (Silicon limited current)	68	A
$I_D$ (Package limited)	55	A
$P_D$	140	W
$R_{DS(ON)Typ}$	12	m $\Omega$

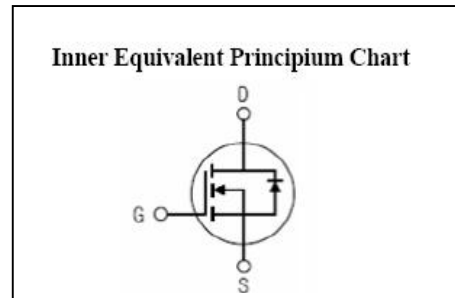
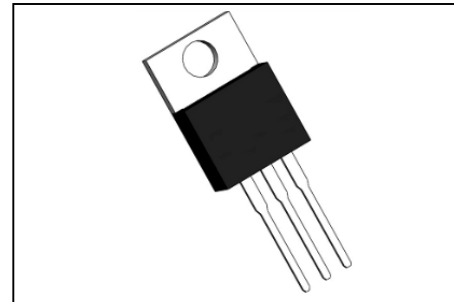

### Absolute ( $T_J = 25^\circ\text{C}$ unless otherwise specified)

Symbol	Parameter	Rating	Units
$V_{DSS}$	Drain-to-Source Voltage	100	V
$I_D$	Continuous Drain Current $T_C = 25^\circ\text{C}$	68	A
	Continuous Drain Current $T_C = 100^\circ\text{C}$	43	A
$I_{DM}^{a1}$	Pulsed Drain Current $T_C = 25^\circ\text{C}$	272	A
$V_{GS}$	Gate-to-Source Voltage	$\pm 20$	V
$E_{AS}^{a2}$	Avalanche Energy	295.8	mJ
$P_D$	Power Dissipation $T_C = 25^\circ\text{C}$	140	W
	Derating Factor above $25^\circ\text{C}$	1.12	W/ $^\circ\text{C}$
$T_J, T_{stg}$	Operating Junction and Storage Temperature Range	150, -55 to 150	$^\circ\text{C}$
$T_L$	Maximum Temperature for Soldering	300	$^\circ\text{C}$

**Electrical Characteristics** ( $T_j = 25^\circ\text{C}$  unless otherwise specified):

<b>OFF Characteristics</b>						
Symbol	Parameter	Test Conditions	Rating			Units
			Min.	Typ.	Max.	
$V_{DSS}$	Drain to Source Breakdown Voltage	$V_{GS}=0V, I_D=250\mu A$	100	--	--	V
$I_{DSS}$	Drain to Source Leakage Current	$V_{DS}=100V, V_{GS}=0V, T_j=25^\circ\text{C}$	--	--	1	$\mu A$
		$V_{DS}=80V, V_{GS}=0V, T_j=125^\circ\text{C}$	--	--	100	
$I_{GSS(F)}$	Gate to Source Forward Leakage	$V_{GS}=20V$	--	--	100	nA
$I_{GSS(R)}$	Gate to Source Reverse Leakage	$V_{GS}=-20V$	--	--	-100	nA

<b>ON Characteristics</b>						
Symbol	Parameter	Test Conditions	Rating			Units
			Min.	Typ.	Max.	
$R_{DS(ON)}$	Drain-to-Source On-Resistance	$V_{GS}=10V, I_D=19A$	--	12	15	$m\Omega$
		$V_{GS}=6V, I_D=15A$	--	13	16.5	$m\Omega$
		$V_{GS}=4.5V, I_D=12A$	--	15	19	$m\Omega$
$V_{GS(TH)}$	Gate Threshold Voltage	$V_{DS}=V_{GS}, I_D=250\mu A$	1.0	1.9	3.0	V
Pulse width $t_p \leq 300\mu s, \delta \leq 2\%$						

<b>Dynamic Characteristics</b>						
Symbol	Parameter	Test Conditions	Rating			Units
			Min.	Typ.	Max.	
$R_g$	Gate resistance	$V_{GS}=0V, V_{DS}=0V, f=1\text{MHz}$	--	0.77	--	$\Omega$
$C_{iss}$	Input Capacitance	$V_{GS}=0V, V_{DS}=50V, f=1.0\text{MHz}$	--	5401	--	pF
$C_{oss}$	Output Capacitance		--	197	--	
$C_{rss}$	Reverse Transfer Capacitance		--	162	--	

<b>Resistive Switching Characteristics</b>						
Symbol	Parameter	Test Conditions	Rating			Units
			Min.	Typ.	Max.	
$t_{d(ON)}$	Turn-on Delay Time	$V_{GS}=10V, R_G=2\Omega, V_{DD}=50V, I_D=30A$	--	23	--	ns
$t_r$	Rise Time		--	15	--	
$t_{d(OFF)}$	Turn-Off Delay Time		--	78.5	--	
$t_f$	Fall Time		--	10.4	--	
$Q_g$	Total Gate Charge	$I_D=30A, V_{DD}=50V, V_{GS}=10V$	--	112.65	--	nC
$Q_{gs}$	Gate to Source Charge		--	17.3	--	
$Q_{gd}$	Gate to Drain ("Miller") Charge		--	30.95	--	

Source-Drain Diode Characteristics						
Symbol	Parameter	Test Conditions	Rating			Units
			Min.	Typ.	Max.	
$I_S$	Continuous Source Current (Body Diode)	$T_C = 25\text{ }^\circ\text{C}$	--	--	68	A
$I_{SM}$	Maximum Pulsed Current (Body Diode)		--	--	272	A
$V_{SD}$	Diode Forward Voltage	$I_S=19\text{A}, V_{GS}=0\text{V}$	--	--	1.2	V
$t_{rr}$	Reverse Recovery Time	$di/dt=100\text{A}/\mu\text{s}$ $I_F=30\text{A}$	--	57	--	ns
$Q_{rr}$	Reverse Recovery Charge		--	126.4	--	nC
Pulse width $t_p \leq 300\mu\text{s}$ , $\delta \leq 2\%$						

Symbol	Parameter	Max.	Units
$R_{\theta JC}$	Junction-to-Case	0.89	$^\circ\text{C}/\text{W}$
$R_{\theta JA}$	Junction-to-Ambient	62.5	$^\circ\text{C}/\text{W}$

<sup>a1</sup>: Repetitive rating; pulse width limited by maximum junction temperature

<sup>a2</sup>:  $L=0.5\text{mH}, I_{as}=34.4\text{A}$  Start  $T_J=25^\circ\text{C}$

Characteristics Curve:

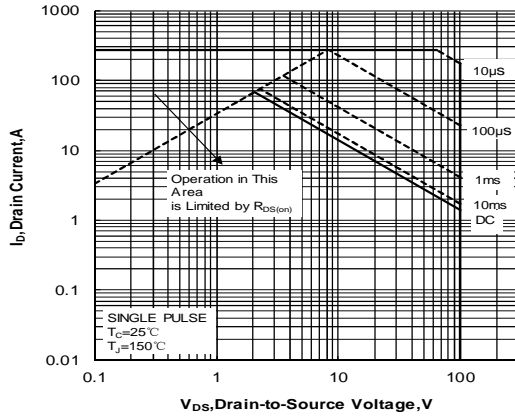

Figure 1 . Maximum Safe Operating Area

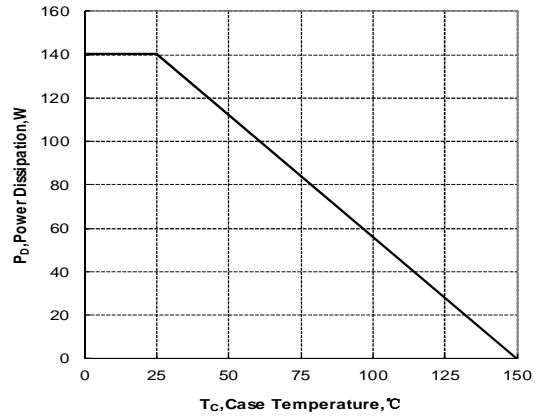

Figure 2. Maximum Power Dissipation vs Case Temperature

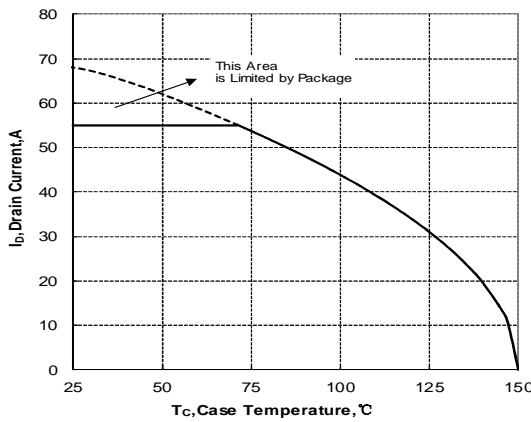

Figure 3. Maximum Continuous Drain Current vs Case Temperature

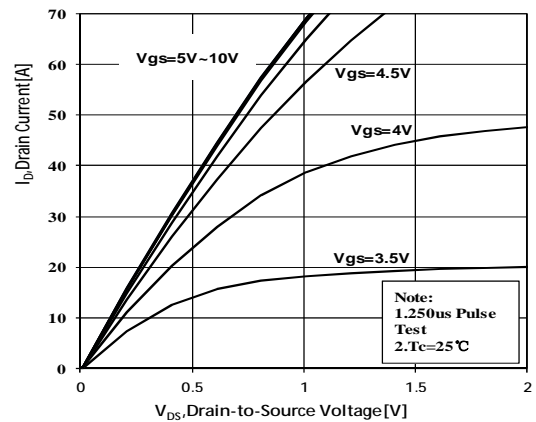

Figure 4. Typical output Characteristics

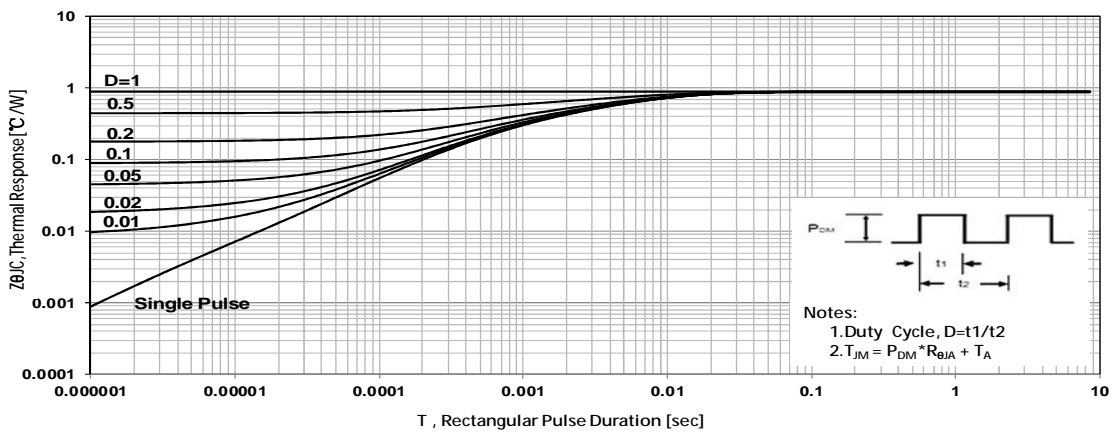

Figure 5 Maximum Effective Thermal Impedance , Junction to Case

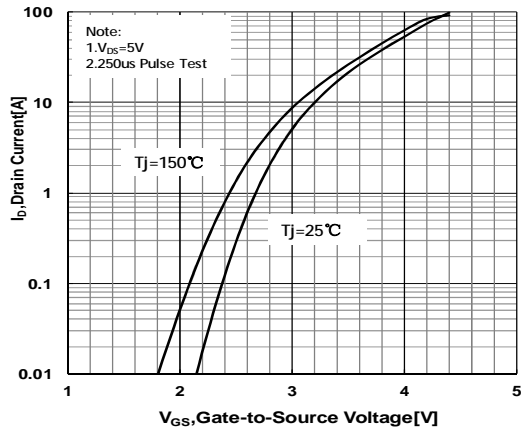

Figure 6 Typical Transfer Characteristics

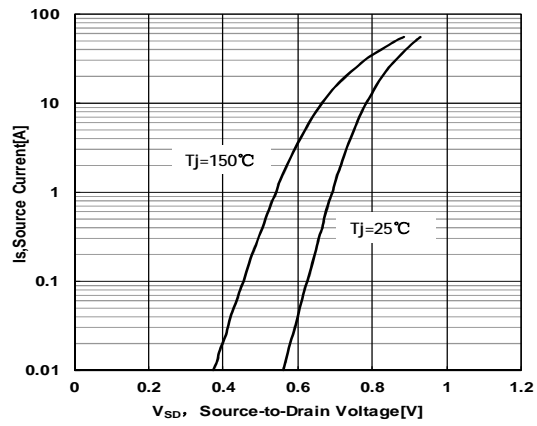

Figure 7 Typical Body Diode Transfer Characteristics

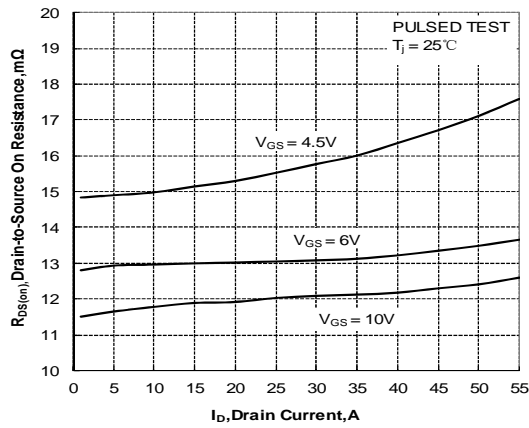

Figure 8. Drain-to-Source On Resistance vs Drain Current

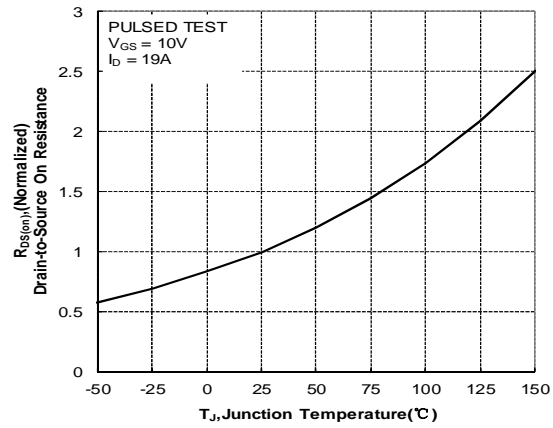

Figure 9. Normalized On Resistance vs Junction Temperature

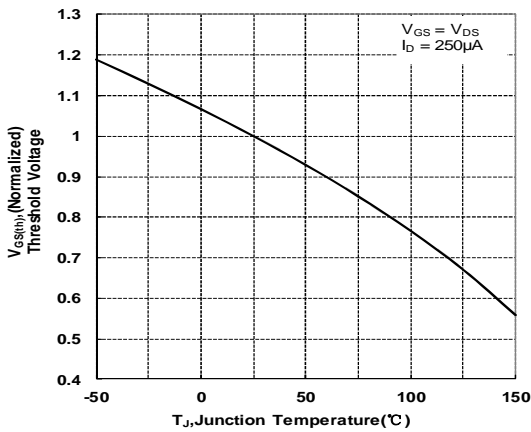

Figure 10. Normalized Threshold Voltage vs Junction Temperature

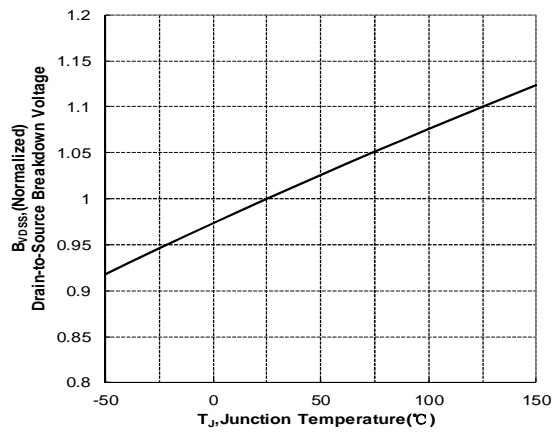

Figure 11. Normalized Breakdown Voltage vs Junction Temperature

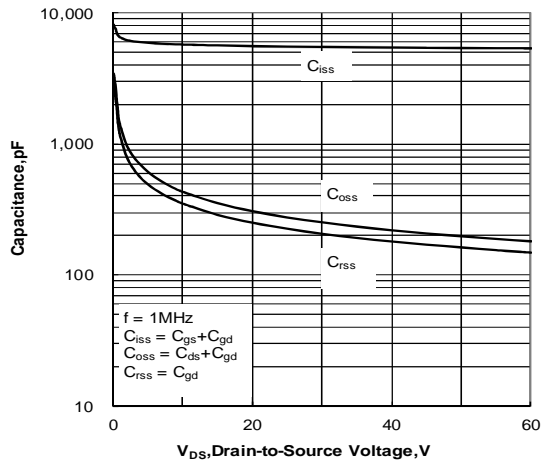

Figure 12. Capacitance Characteristics

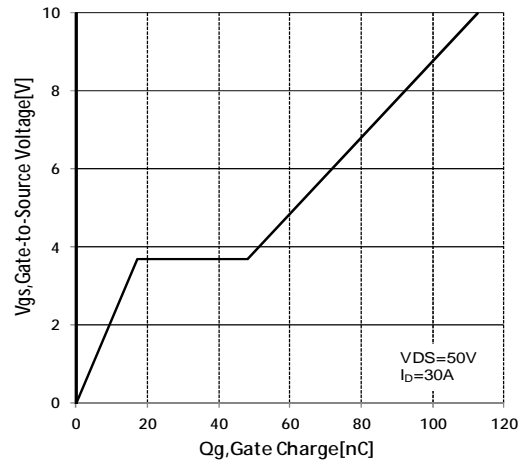

Figure 13 Typical Gate Charge vs Gate to Source Voltage

**Test Circuit and Waveform**



Figure 14. Gate Charge Test Circuit

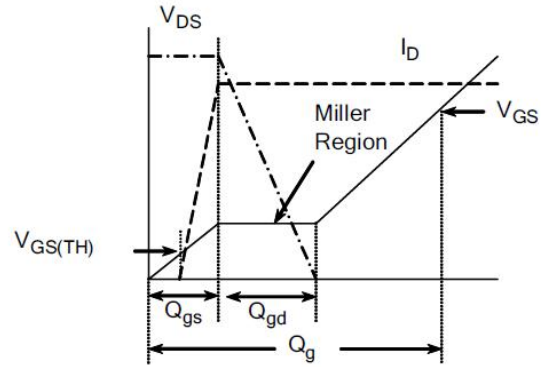

Figure 15. Gate Charge Waveforms



Figure 16. Resistive Switching Test Circuit

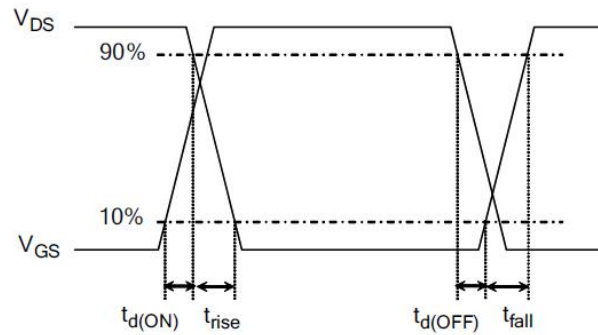

Figure 17. Resistive Switching Waveforms

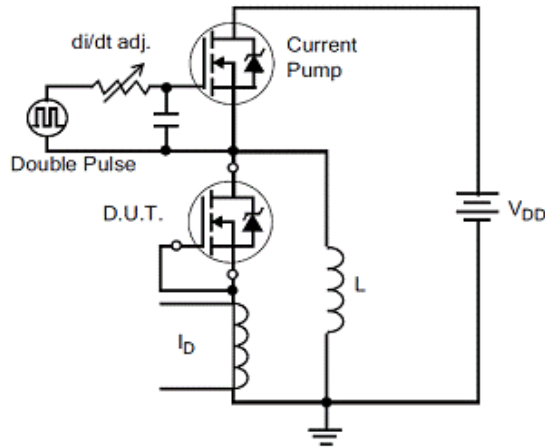

Figure 18. Diode Reverse Recovery Test Circuit

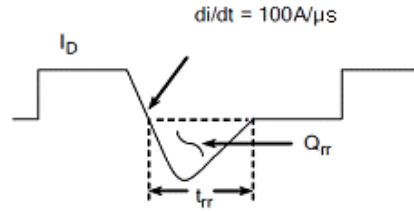

Figure 19. Diode Reverse Recovery Waveform



Figure20.Unclamped Inductive Switching Test Circuit

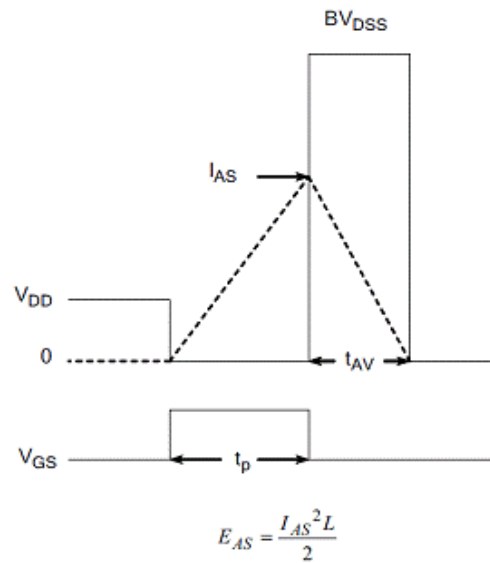
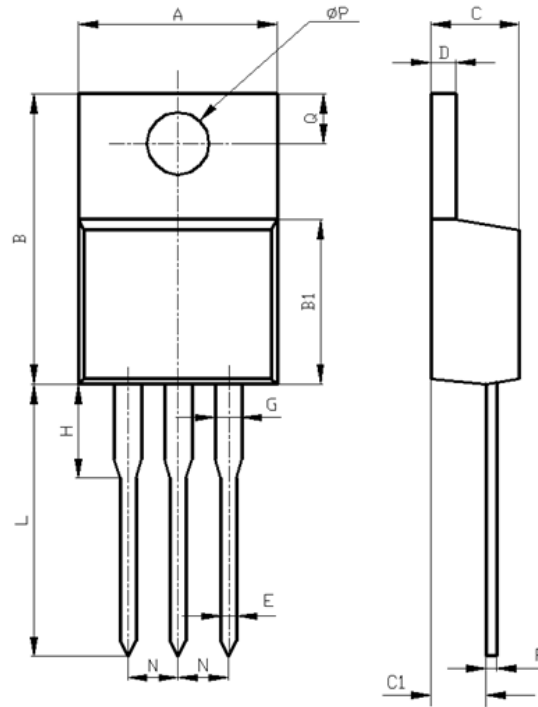

Figure21.Unclamped Inductive Switching Waveform



**Package Information:**



Items	Values(mm)	
	MIN	MAX
A	9.60	10.6
B	15.0	16.0
B1	8.90	9.50
C	4.30	4.80
C1	2.30	3.10
D	1.20	1.40
E	0.70	0.90
F	0.30	0.60
G	1.17	1.37
H	2.70	3.80
L*	12.6	14.8
N	2.34	2.74
Q	2.40	3.00
$\phi P$	3.50	3.90

\*adjustable

TO-220 Package

**The name and content of poisonous and harmful material in products**

	Hazardous Substance									
	Pb	Hg	Cd	Cr(VI)	PBB	PBDE	DI BP	DEHP	DBP	BBP
Limit	≤0.1%	≤0.1%	≤0.01%	≤0.1%	≤0.1%	≤0.1%	≤0.1%	≤0.1%	≤0.1%	≤0.1%
Lead Frame	○	○	○	○	○	○	○	○	○	○
Molding	○	○	○	○	○	○	○	○	○	○
Chip	○	○	○	○	○	○	○	○	○	○
Wire Bonding	○	○	○	○	○	○	○	○	○	○
Solder	×	○	○	○	○	○	○	○	○	○
Note	○: Means the hazardous material is under the criterion of 2011/65/EU. ×: Means the hazardous material exceeds the criterion of 2011/65/EU. The plumbum element of solder exist in products presently, but within the allowed range of Eurogroup's RoHS.									

**Warnings**

1. Exceeding the maximum ratings of the device in performance may cause damage to the device, even the permanent failure, which may affect the dependability of the machine. It is suggested to be used under 80 percent of the maximum ratings of the device.
2. When installing the heatsink, please pay attention to the torsional moment and the smoothness of the heatsink.
3. VDMOSFETs is the device which is sensitive to the static electricity, it is necessary to protect the device from being damaged by the static electricity when using it.
4. This publication is made by Huajing Microelectronics and subject to regular change without notice.

**WUXI CHINA RESOURCES HUAJING MICROELECTRONICS CO., LTD.**

Add: No.14 Liangxi RD. Wuxi, Jiangsu, China    Mail:214061    <http://www.crhj.com.cn>  
Tel: +86 0510-85807228    Fax: +86- 0510-85800864

Marketing Part:                      Post: 214061                      Tel: +86 0510-81805277/81805336  
Fax: +86 0510-85800360/85803016

Application and Service: Post: 214061    Tel / Fax: +86- 0510-81805243/81805110