



## CS7N65 A4TDY

**General Description:**

CS7N65 A4TDY, the silicon N-channel Enhanced VDMOSFETs, is obtained by the self-aligned planar Technology which reduce the conduction loss, improve switching performance and enhance the avalanche energy. The transistor can be used in various power switching circuit for system miniaturization and higher efficiency. The package form is TO-252, which accords with the RoHS standard.

**Features:**

- I **Fast Switching**
- I **ESD Improved Capability**
- I **Low Gate Charge** (Typical Data:24nC)
- I **Low Reverse transfer capacitances**(Typical:4.5pF)
- I **100% Single Pulse avalanche energy Test**

**Applications:**

Power switch circuit of adaptor and charger.

**Absolute** (Tc= 25°C unless otherwise specified):

Symbol	Parameter	Rating	Units
V <sub>DSS</sub>	Drain-to-Source Voltage	650	V
I <sub>D</sub>	Continuous Drain Current	7	A
	Continuous Drain Current T <sub>C</sub> = 100 °C	4.5	A
I <sub>DM</sub> <sup>a1</sup>	Pulsed Drain Current	28	A
V <sub>GS</sub>	Gate-to-Source Voltage	±30	V
E <sub>AS</sub> <sup>a2</sup>	Single Pulse Avalanche Energy	450	mJ
E <sub>AR</sub> <sup>a1</sup>	Avalanche Energy ,Repetitive	54	mJ
I <sub>AR</sub> <sup>a1</sup>	Avalanche Current	3.3	A
dv/dt <sup>a3</sup>	Peak Diode Recovery dv/dt	5.0	V/ns
P <sub>D</sub>	Power Dissipation	95	W
	Derating Factor above 25°C	0.76	W/°C
V <sub>ESD(G-S)</sub>	Gate source ESD (HBM-C= 100pF, R=1.5kΩ)	3000	v
T <sub>J</sub> , T <sub>stg</sub>	Operating Junction and Storage Temperature Range	150, -55 to 150	°C
T <sub>L</sub>	Maximum Temperature for Soldering	300	°C

V <sub>DSS</sub>	650	V
I <sub>D</sub>	7	A
P <sub>D</sub> (T <sub>C</sub> =25°C)	95	W
R <sub>DS(ON)Typ</sub>	1.1	Ω

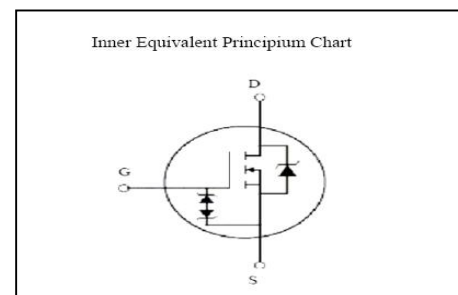
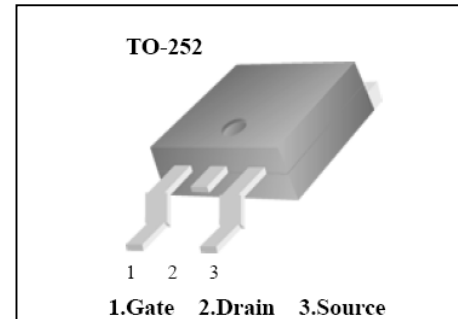

**Electrical Characteristics** (Tc= 25°C unless otherwise specified):

<b>OFF Characteristics</b>						
Symbol	Parameter	Test Conditions	Rating			Units
			Min.	Typ.	Max.	
V <sub>DSS</sub>	Drain to Source Breakdown Voltage	V <sub>GS</sub> =0V, I <sub>D</sub> =250μA	650	--	--	V
ΔBV <sub>DSS</sub> /ΔT <sub>J</sub>	Bvdss Temperature Coefficient	ID=250uA, Reference 25°C	--	0.67	--	V/°C
I <sub>DSS</sub>	Drain to Source Leakage Current	V <sub>DS</sub> = 650V, V <sub>GS</sub> = 0V, T <sub>a</sub> = 25°C	--	--	1	μA
		V <sub>DS</sub> =520V, V <sub>GS</sub> = 0V, T <sub>a</sub> = 125°C	--	--	100	
I <sub>GSS(F)</sub>	Gate to Source Forward Leakage	V <sub>GS</sub> =+20V	--	--	10	μA
I <sub>GSS(R)</sub>	Gate to Source Reverse Leakage	V <sub>GS</sub> =-20V	--	--	-10	μA

<b>ON Characteristics</b>						
Symbol	Parameter	Test Conditions	Rating			Units
			Min.	Typ.	Max.	
R <sub>DS(ON)</sub>	Drain-to-Source On-Resistance	V <sub>GS</sub> =10V, I <sub>D</sub> =3.5A	--	1.1	1.4	Ω
V <sub>GS(TH)</sub>	Gate Threshold Voltage	V <sub>DS</sub> = V <sub>GS</sub> , I <sub>D</sub> = 250μA	2.0		4.0	V
Pulse width tp ≤ 300μs, δ ≤ 2%						

<b>Dynamic Characteristics</b>						
Symbol	Parameter	Test Conditions	Rating			Units
			Min.	Typ.	Max.	
g <sub>fs</sub>	Forward Trans conductance	V <sub>DS</sub> =15V, I <sub>D</sub> =3.5A	--	6.5	--	S
C <sub>iss</sub>	Input Capacitance	V <sub>GS</sub> = 0V V <sub>DS</sub> = 25V f = 1.0MHz	--	1080	--	pF
C <sub>oss</sub>	Output Capacitance		--	93	--	
C <sub>rss</sub>	Reverse Transfer Capacitance		--	4.5	--	

<b>Resistive Switching Characteristics</b>						
Symbol	Parameter	Test Conditions	Rating			Units
			Min.	Typ.	Max.	
t <sub>d(ON)</sub>	Turn-on Delay Time	I <sub>D</sub> =7.0A V <sub>DD</sub> = 520V V <sub>GS</sub> = 10V R <sub>G</sub> =9.1Ω	--	11	--	ns
t <sub>r</sub>	Rise Time		--	10	--	
t <sub>d(OFF)</sub>	Turn-Off Delay Time		--	36	--	
t <sub>f</sub>	Fall Time		--	18	--	
Q <sub>g</sub>	Total Gate Charge	I <sub>D</sub> =7.0A V <sub>DD</sub> =520V V <sub>GS</sub> = 10V	--	24		nC
Q <sub>gs</sub>	Gate to Source Charge		--	5	--	
Q <sub>gd</sub>	Gate to Drain ("Miller") Charge		--	8	--	

Source-Drain Diode Characteristics						
Symbol	Parameter	Test Conditions	Rating			Units
			Min.	Typ.	Max.	
$I_S$	Continuous Source Current (Body Diode)		--	--	7	A
$I_{SM}$	Maximum Pulsed Current (Body Diode)		--	--	28	A
$V_{SD}$	Diode Forward Voltage	$I_S=7.0A, V_{GS}=0V$	--	--	1.5	V
$t_{rr}$	Reverse Recovery Time	$I_S=7.0A, T_j = 25^\circ C$	--	280	--	ns
$Q_{rr}$	Reverse Recovery Charge	$dI_F/dt=100A/us, V_{GS}=0V$	--	1200	--	nC
Pulse width $t_p \leq 300\mu s, \delta \leq 2\%$						

Symbol	Parameter	Typ.	Units
$R_{\theta JC}$	Junction-to-Case	1.32	$^\circ C/W$
$R_{\theta JA}$	Junction-to-Ambient	62	$^\circ C/W$

Gate-source Zener diode						
Symbol	Parameter	Test Conditions	Rating			Units
			Min.	Typ.	Max.	
$V_{GSO}$	Gate-source breakdown voltage	$I_{GS} = \pm 1mA (Open Drain)$	30			V
<p>The built-in back-to-back Zener diodes have specifically been designed to enhance not only the device's ESD capability, but also to make them safely absorb possible voltage transients that may occasionally be applied from gate to source. In this respect the Zener voltage is appropriate to achieve an efficient and cost-effective intervention to protect the device's integrity. These integrated Zener diodes thus avoid the usage of external components.</p>						

<sup>a1</sup>: Repetitive rating; pulse width limited by maximum junction temperature

<sup>a2</sup>:  $L=10.0mH, I_D=9.5A, Start T_j=25^\circ C$

<sup>a3</sup>:  $I_{SD}=7A, di/dt \leq 100A/us, V_{DD} \leq BV_{DS}, Start T_j=25^\circ C$

Characteristics Curve:

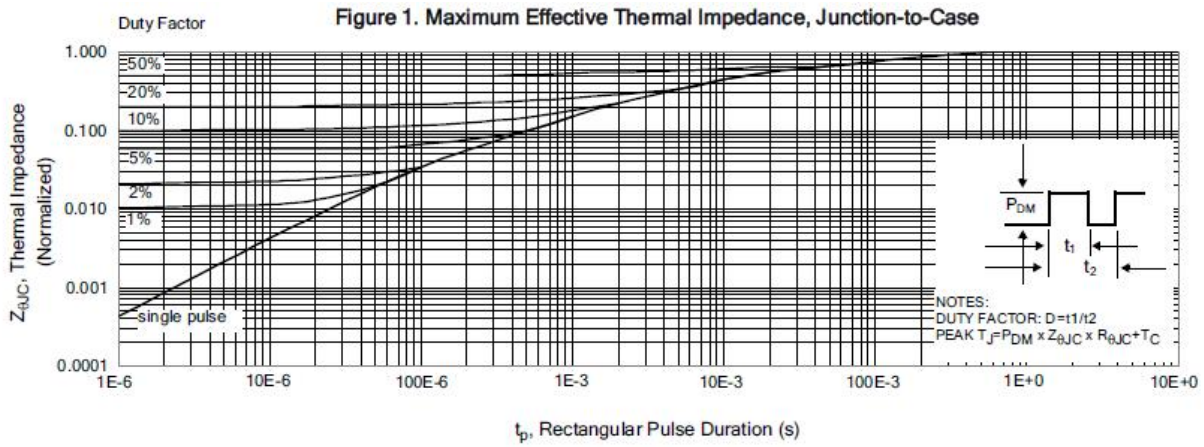

**Figure 2. Maximum Power Dissipation vs Case Temperature**

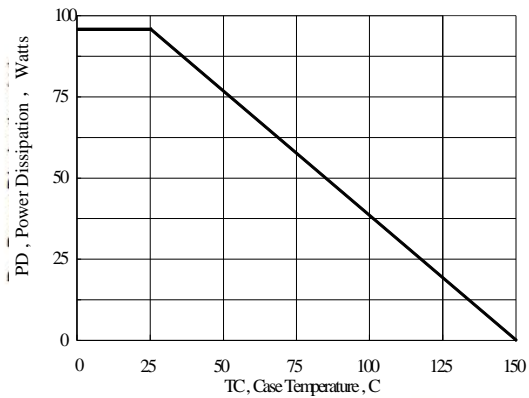

**Figure 3. Maximum Continuous Drain Current vs Case Temperature**

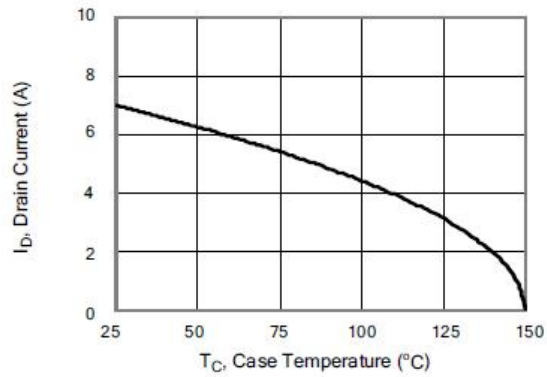

**Figure 4. Typical Output Characteristics**

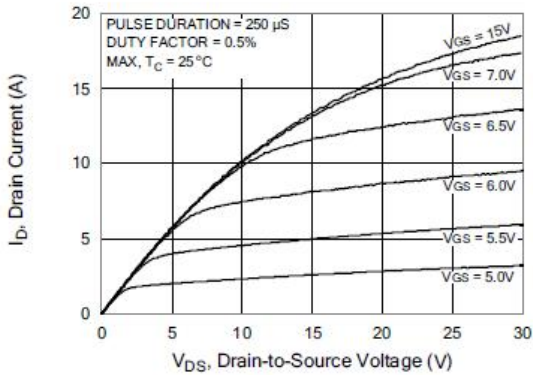

**Figure 5. Typical Drain-to-Source ON Resistance vs Gate Voltage and Drain Current**

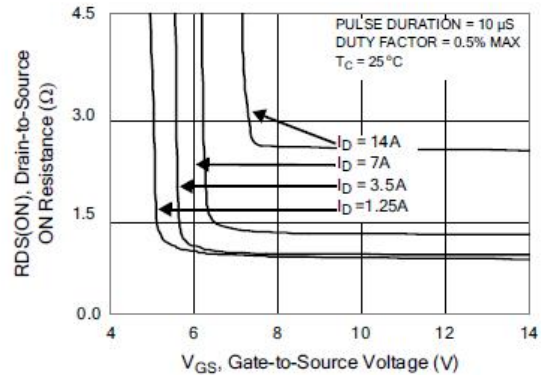

Figure 6. Maximum Peak Current Capability

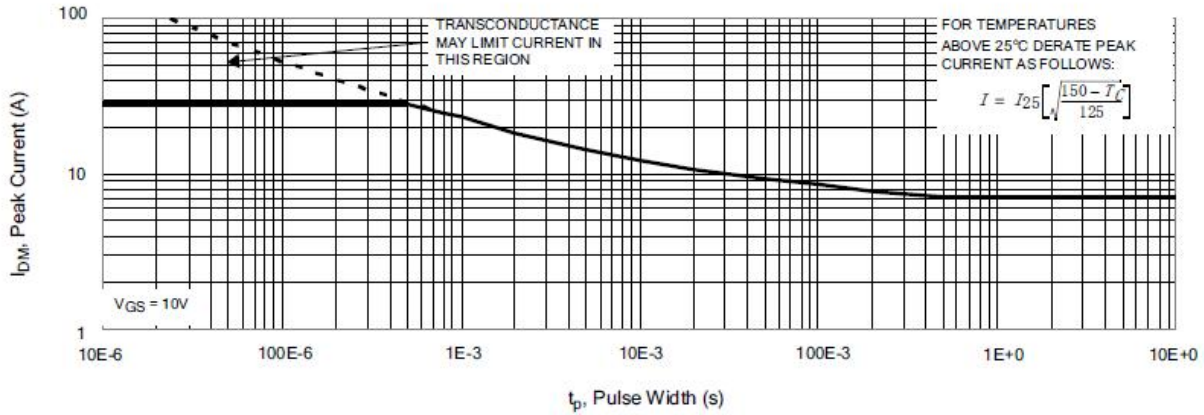

Figure 7. Typical Transfer Characteristics

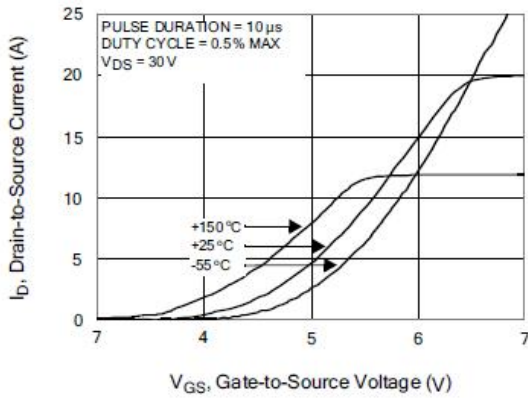

Figure 8. Unclamped Inductive Switching Capability

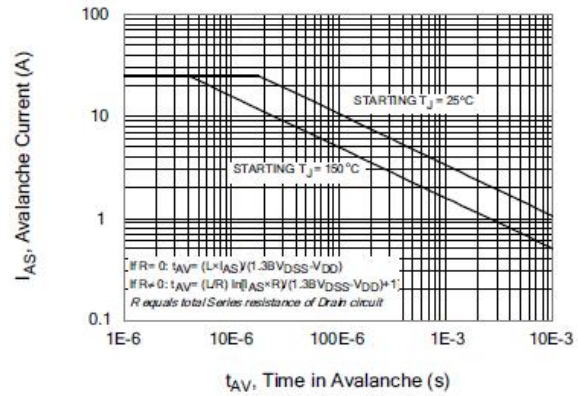

Figure 9. Typical Drain-to-Source ON Resistance vs Drain Current

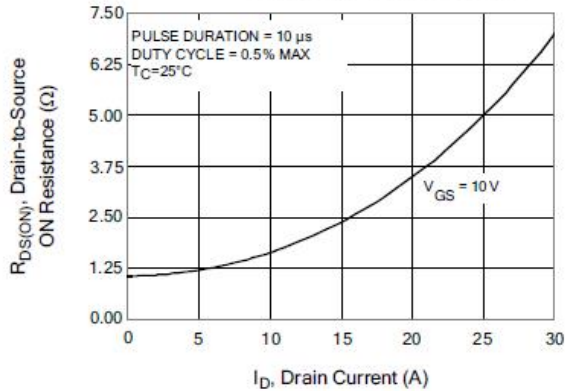

Figure 10. Typical Drain-to-Source ON Resistance vs Junction Temperature

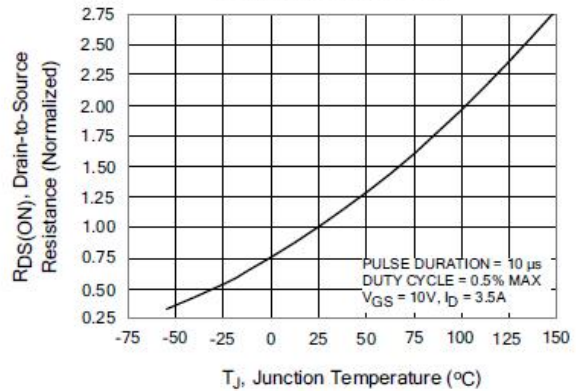

Figure 11. Typical Breakdown Voltage vs Junction Temperature

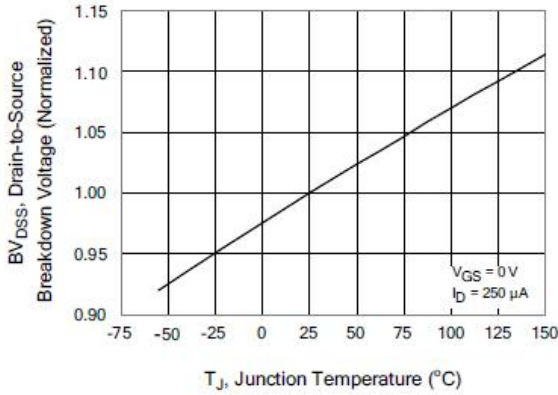

Figure 12. Typical Threshold Voltage vs Junction Temperature

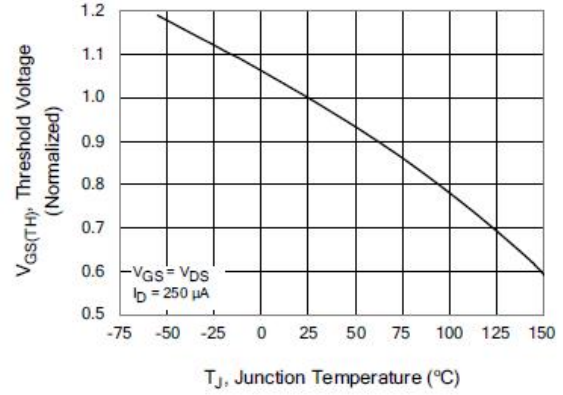

Figure 13. Maximum Forward Bias Safe Operating Area

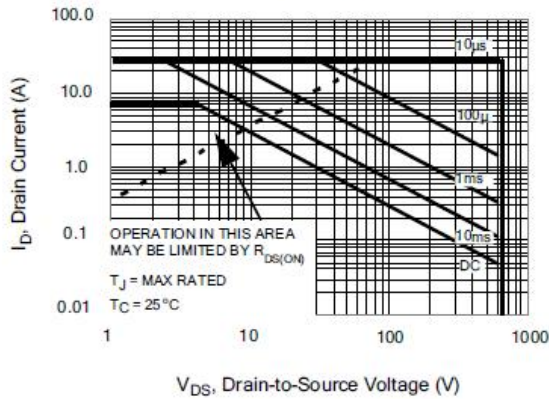

Figure 14. Typical Capacitance vs Drain-to-Source Voltage

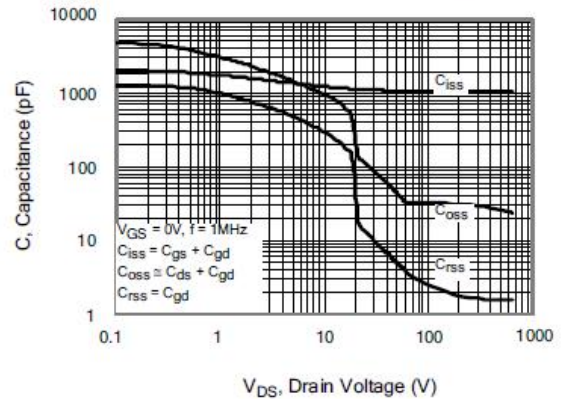

Figure 15. Typical Gate Charge vs Gate-to-Source Voltage

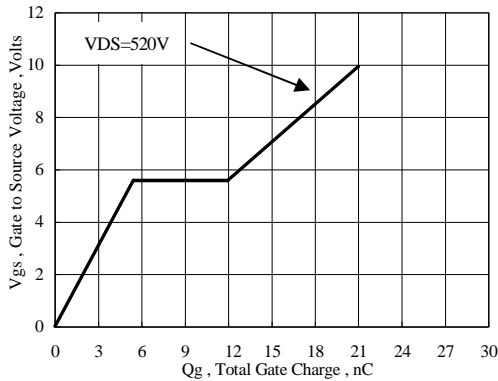
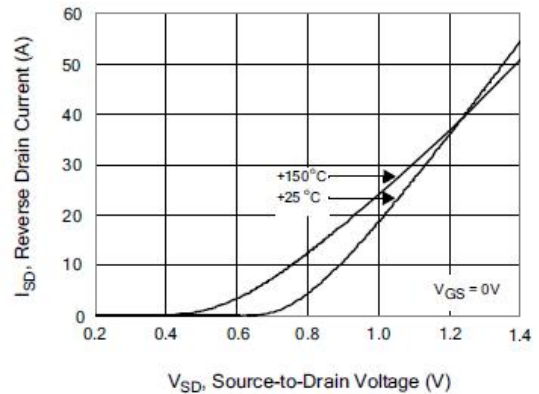

Figure 16. Typical Body Diode Transfer Characteristics



**Test Circuit and Waveform**



Figure 17. Gate Charge Test Circuit

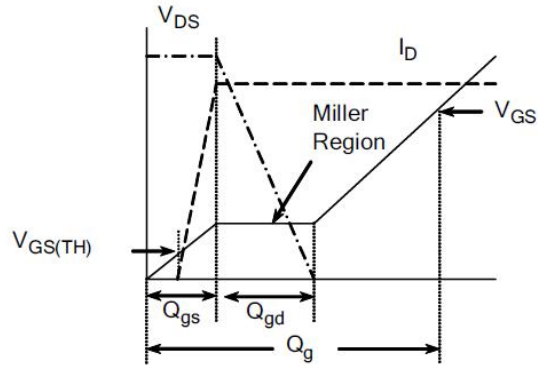

Figure 18. Gate Charge Waveform



Figure 19. Resistive Switching Test Circuit

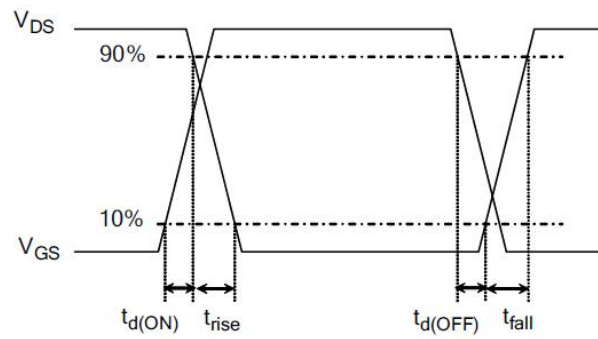

Figure 20. Resistive Switching Waveforms

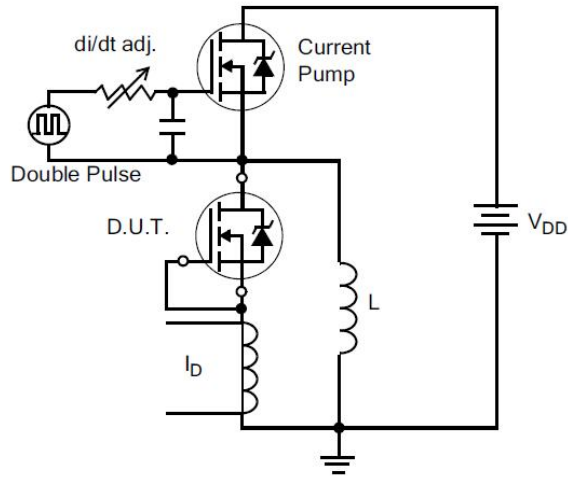

Figure 21. Diode Reverse Recovery Test Circuit

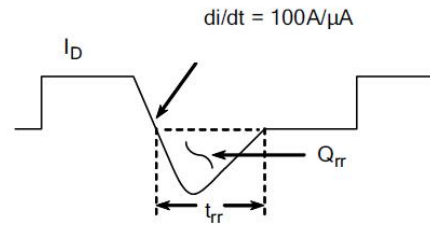

Figure 22. Diode Reverse Recovery Waveform

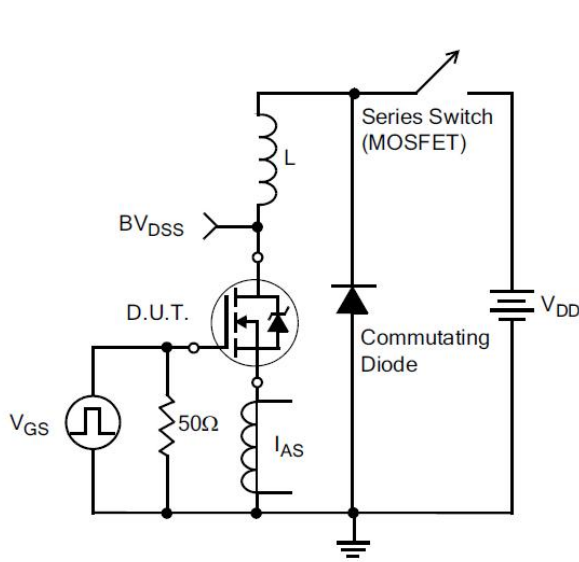

Figure 23. Unclamped Inductive Switching Test Circuit

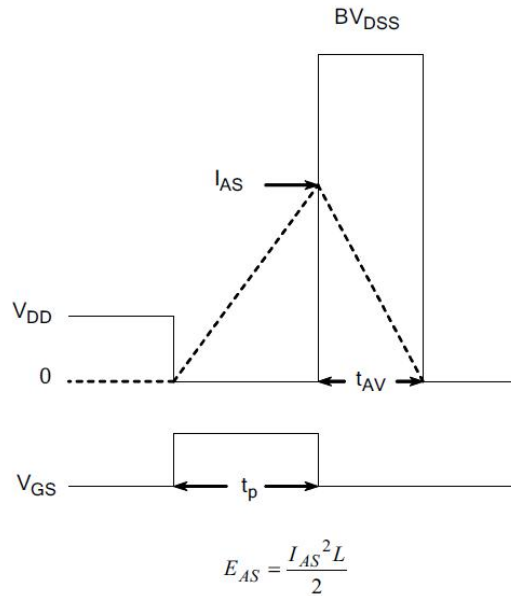
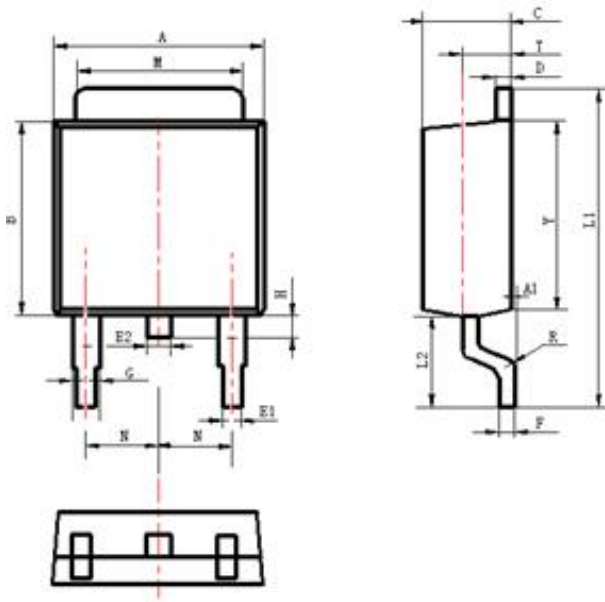

Figure 24. Unclamped Inductive Switching Waveforms



**Package Information:**



Items	Values(mm)	
	MIN	MAX
A	6.30	6.90
A1	0	0.13
B	5.70	6.30
C	2.10	2.50
D	0.30	0.60
E1	0.60	0.90
E2	0.70	1.00
F	0.30	0.60
G	0.70	1.00
L1	9.60	10.30
L2	2.70	3.10
H	0.60	1.00
M	5.10	5.50
N	2.09	2.49
R	0.3	
T	1.40	1.60
Y	5.10	6.30

TO-252 Package

**The name and content of poisonous and harmful material in products**

Part's Name	Hazardous Substance					
	Pb	Hg	Cd	Cr(VI)	PBB	PBDE
Limit	≤0.1%	≤0.1%	≤0.01%	≤0.1%	≤0.1%	≤0.1%
Lead Frame	○	○	○	○	○	○
Molding Compound	○	○	○	○	○	○
Chip	○	○	○	○	○	○
Wire Bonding	○	○	○	○	○	○
Solder	×	○	○	○	○	○
Note	○: means the hazardous material is under the criterion of SJ/T11363-2006. ×: means the hazardous material exceeds the criterion of SJ/T11363-2006. The plumbum element of solder exist in products presently, but within the allowed range of Eurogroup's RoHS.					

**Warnings**

1. Exceeding the maximum ratings of the device in performance may cause damage to the device, even the permanent failure, which may affect the dependability of the machine. It is suggested to be used under 80 percent of the maximum ratings of the device.
2. When installing the heatsink, please pay attention to the torsional moment and the smoothness of the heatsink.
3. VDMOSFETs is the device which is sensitive to the static electricity, it is necessary to protect the device from being damaged by the static electricity when using it.
4. This publication is made by Huajing Microelectronics and subject to regular change without notice.

**WUXI CHINA RESOURCES HUAJING MICROELECTRONICS CO., LTD.**

Add: No.14 Liangxi RD. Wuxi, Jiangsu, China Mail:214061 <http://www.crhj.com.cn>  
Tel: +86 0510-85807228 Fax: +86- 0510-85800864

Marketing Part: Post: 214061 Tel: +86 0510-81805277/81805336  
Fax: +86 0510-85800360/85803016  
E-mail: [sales@hj.crmicro.com](mailto:sales@hj.crmicro.com)

Application and Service: Post: 214061 Tel / Fax: +86- 0510-81805243/81805110