

**CS90N03 B4****General Description:**

CS90N03 B4, the silicon N-channel Enhanced VDMOSFETs, is obtained by the self-aligned planar Technology which reduce the conduction loss, improve switching performance and enhance the avalanche energy. The transistor can be used in various power switching circuit for system miniaturization and higher efficiency. The package form is TO-252, which accords with the RoHS standard.

Features:

- l Trench FET Power MOSFET
- l Low ON Resistance($R_{dson} \leq 6m\Omega$)
- l Low Gate Charge (Typical Data:34nC)
- l Low Reverse transfer capacitances(Typical:291pF)
- l 100% Single Pulse avalanche energy Test

Applications:

Automotive,DC Motor Control and Class D Amplifier.

Absolute ($T_c = 25^\circ\text{C}$ unless otherwise specified):

Symbol	Parameter	Rating	Units
V_{DSS}	Drain-to-Source Voltage	25	V
I_D	Continuous Drain Current	90	A
	Continuous Drain Current $T_C = 100^\circ\text{C}$	64	A
I_{DM}^{a1}	Pulsed Drain Current	360	A
V_{GS}	Gate-to-Source Voltage	± 20	V
E_{AS}^{a2}	Single Pulse Avalanche Energy	260	mJ
E_{AR}^{a1}	Avalanche Energy ,Repetitive	31	mJ
I_{AR}^{a1}	Avalanche Current	2.5	A
dv/dt^{a3}	Peak Diode Recovery dv/dt	5	V/ns
P_D	Power Dissipation	80	W
	Derating Factor above 25°C	0.53	W/ $^\circ\text{C}$
T_J, T_{stg}	Operating Junction and Storage Temperature Range	175, -55 to 175	$^\circ\text{C}$
T_L	Maximum Temperature for Soldering	300	$^\circ\text{C}$

V_{DSS}	25	V
I_D	90	A
$P_D(T_C=25^\circ\text{C})$	80	W
$R_{DS(ON)Typ}$	4.8	m Ω

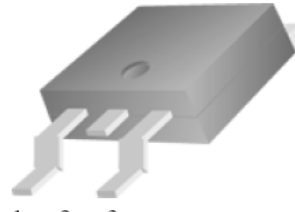
TO-252

1.Gate 2.Drain 3.Source

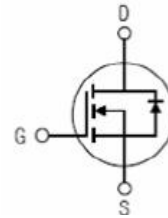
Inner Equivalent Principium Chart

**Electrical Characteristics** (Tc= 25°C unless otherwise specified):

OFF Characteristics						
Symbol	Parameter	Test Conditions	Rating			Units
			Min.	Typ.	Max.	
V _{DSS}	Drain to Source Breakdown Voltage	V _{GS} =0V, I _D =250μA	25	--	--	V
$\Delta BV_{DSS}/\Delta T_J$	Bvdss Temperature Coefficient	I _D =250uA, Reference 25°C	--	0.08	--	V/°C
I _{DSS}	Drain to Source Leakage Current	V _{DS} = 25V, V _{GS} = 0V, T _a = 25°C	--	--	1	μA
		V _{DS} = 20V, V _{GS} = 0V, T _a = 125°C	--	--	10	
I _{GSS(F)}	Gate to Source Forward Leakage	V _{GS} = +20V	--	--	100	nA
I _{GSS(R)}	Gate to Source Reverse Leakage	V _{GS} = -20V	--	--	-100	nA

ON Characteristics						
Symbol	Parameter	Test Conditions	Rating			Units
			Min.	Typ.	Max.	
R _{DS(ON)}	Drain-to-Source On-Resistance	V _{GS} =10V, I _D =30A	--	4.8	6.0	mΩ
V _{GS(TH)}	Gate Threshold Voltage	V _{DS} = V _{GS} , I _D = 250μA	1.0		3.0	V
Pulse width tp ≤ 300μs, δ ≤ 2%						

Dynamic Characteristics						
Symbol	Parameter	Test Conditions	Rating			Units
			Min.	Typ.	Max.	
g _{fs}	Forward Trans conductance	V _{DS} =15V, I _D =35A	--	38	--	S
C _{iss}	Input Capacitance	V _{GS} = 0V V _{DS} =16V f = 1.0MHZ	--	1940	--	pF
C _{oss}	Output Capacitance		--	521	--	
C _{rss}	Reverse Transfer Capacitance		--	291	--	

Resistive Switching Characteristics						
Symbol	Parameter	Test Conditions	Rating			Units
			Min.	Typ.	Max.	
t _{d(ON)}	Turn-on Delay Time	I _D =15A V _{DD} = 15V V _{GS} = 10V R _G = 12.7Ω	--	13	--	ns
t _r	Rise Time		--	43	--	
t _{d(OFF)}	Turn-Off Delay Time		--	52	--	
t _f	Fall Time		--	52	--	
Q _g	Total Gate Charge	I _D =35A V _{DD} =20V V _{GS} = 10V	--	34	--	nC
Q _{gs}	Gate to Source Charge		--	6.0	--	
Q _{gd}	Gate to Drain ("Miller") Charge		--	13.2	--	

Source-Drain Diode Characteristics						
Symbol	Parameter	Test Conditions	Rating			Units
			Min.	Typ.	Max.	
I_S	Continuous Source Current (Body Diode)		--	--	90	A
I_{SM}	Maximum Pulsed Current (Body Diode)		--	--	360	A
V_{SD}	Diode Forward Voltage	$I_S=90A, V_{GS}=0V$	--	--	1.5	V
t_{rr}	Reverse Recovery Time	$I_S=35A, T_J = 25^\circ C$ $dI_F/dt=100A/us,$ $V_{GS}=0V$	--	51	--	ns
Q_{rr}	Reverse Recovery Charge		--	54	--	nC
I_{RRM}	Reverse Recovery Current		--	2.1	--	A
Pulse width $t_p \leq 300\mu s, \delta \leq 2\%$						

Symbol	Parameter	Typ.	Units
$R_{\theta JC}$	Junction-to-Case	1.88	$^\circ C/W$
$R_{\theta JA}$	Junction-to-Ambient	62	$^\circ C/W$

^{a1}: Repetitive rating; pulse width limited by maximum junction temperature

^{a2}: $L=0.1mH, I_D=72A, Start T_J=25^\circ C$

^{a3}: $I_{SD}=60A, di/dt \leq 100A/us, V_{DD} \leq BV_{DS}, Start T_J=25^\circ C$

Characteristics Curve:

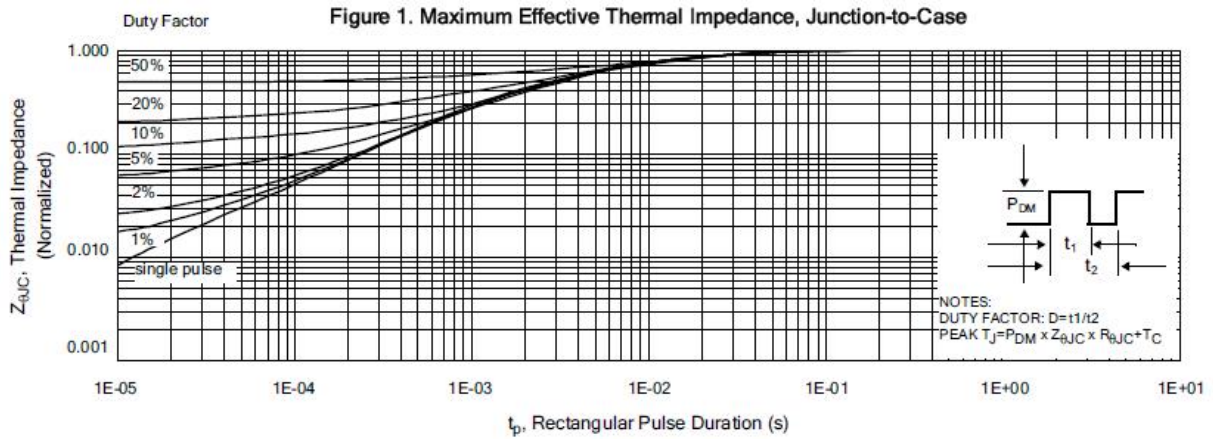

Figure 2. Maximum Power Dissipation vs Case Temperature

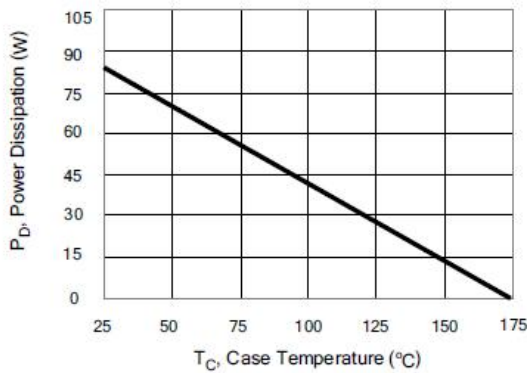

Figure 3. Maximum Continuous Drain Current vs Case Temperature

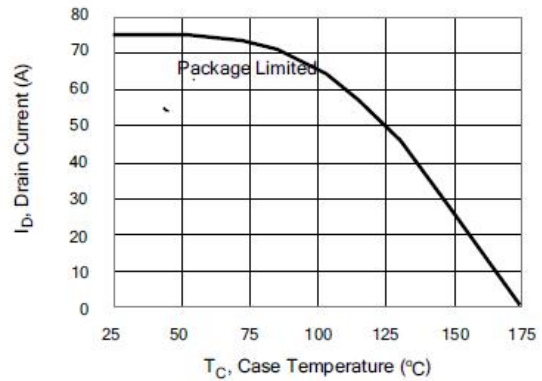

Figure 4. Typical Output Characteristics

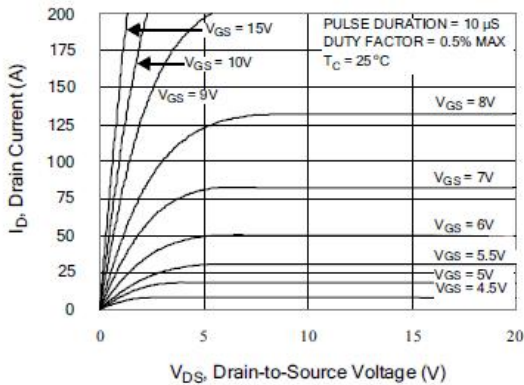

Figure 5. Typical Drain-to-Source ON Resistance vs Gate Voltage and Drain Current

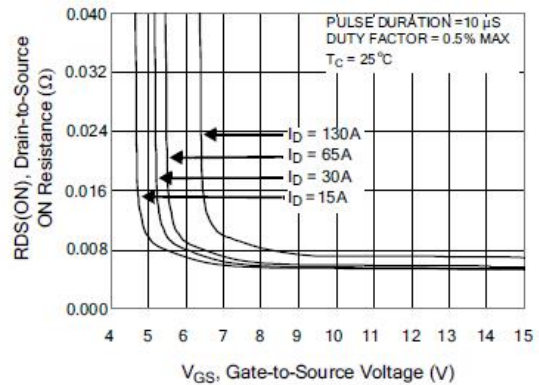

Figure 6. Maximum Peak Current Capability

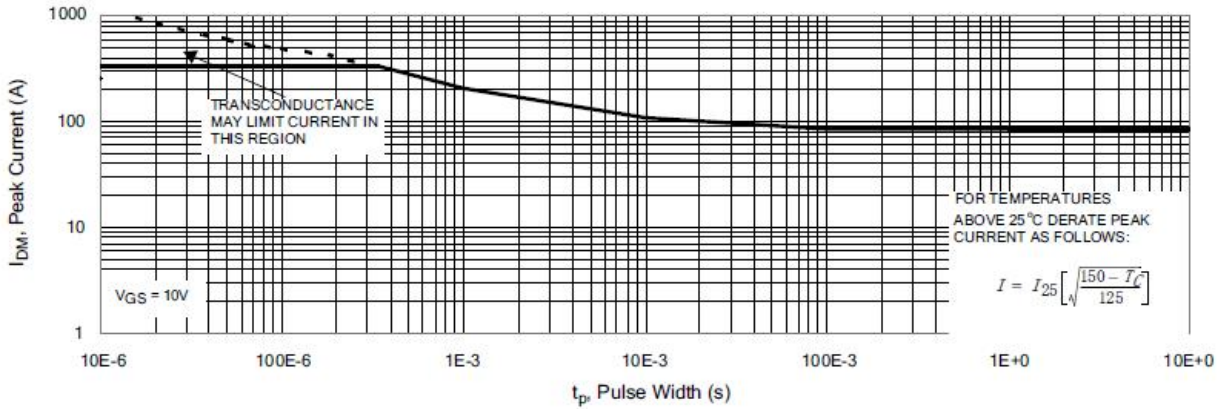

Figure 7. Typical Transfer Characteristics

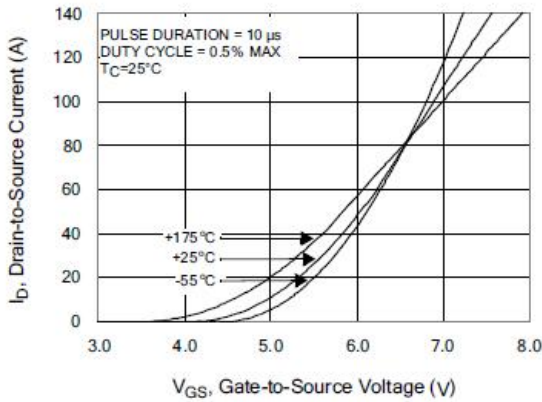

Figure 8. Unclamped Inductive Switching Capability

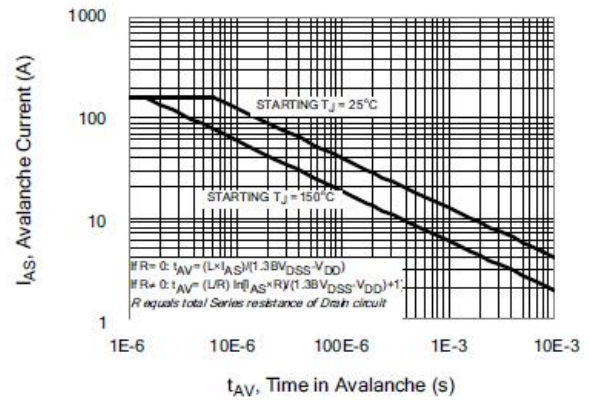

Figure 9. Typical Drain-to-Source ON Resistance vs Drain Current

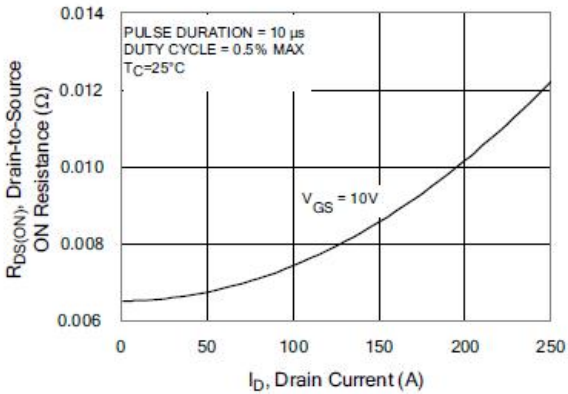

Figure 10. Typical Drain-to-Source ON Resistance vs Junction Temperature

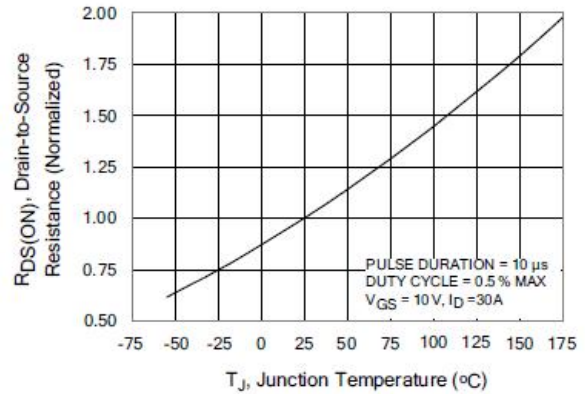

Figure 11. Typical Breakdown Voltage vs Junction Temperature

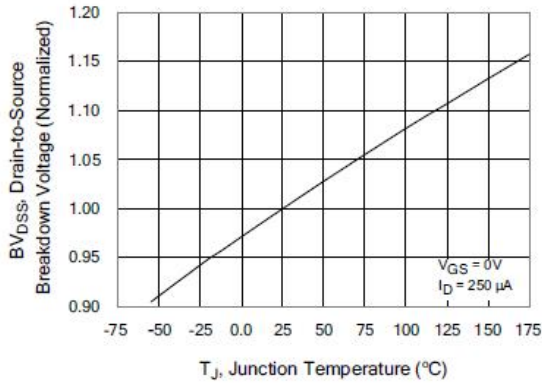

Figure 12. Typical Threshold Voltage vs Junction Temperature

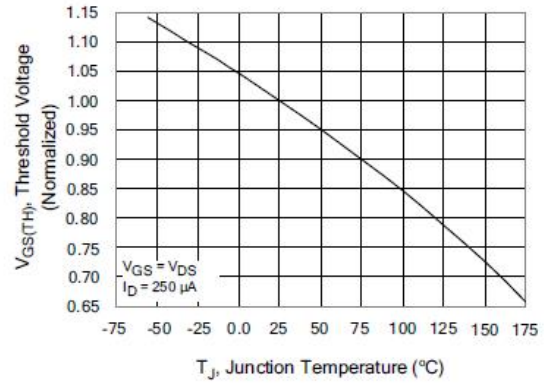

Figure 13. Maximum Forward Bias Safe Operating Area

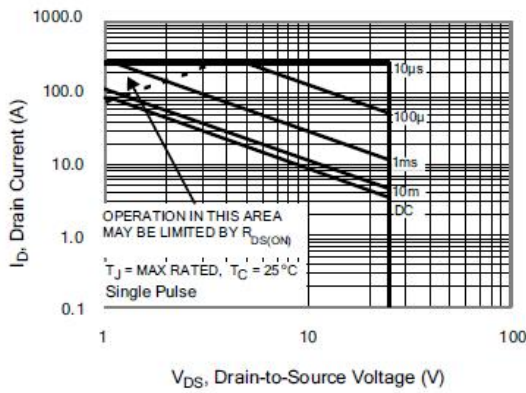

Figure 14. Typical Capacitance vs Drain-to-Source Voltage

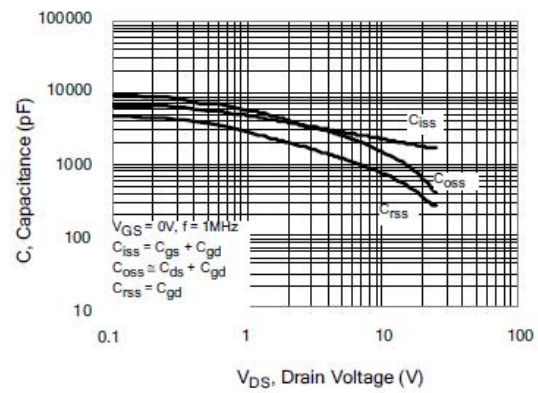

Figure 15. Typical Gate Charge vs Gate-to-Source Voltage

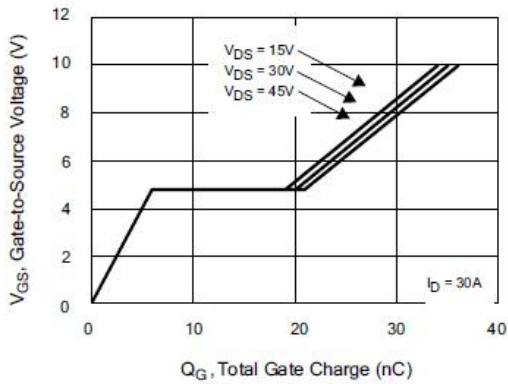
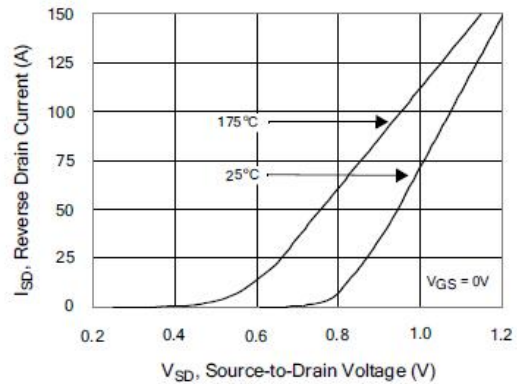

Figure 16. Typical Body Diode Transfer Characteristics



Test Circuit and Waveform

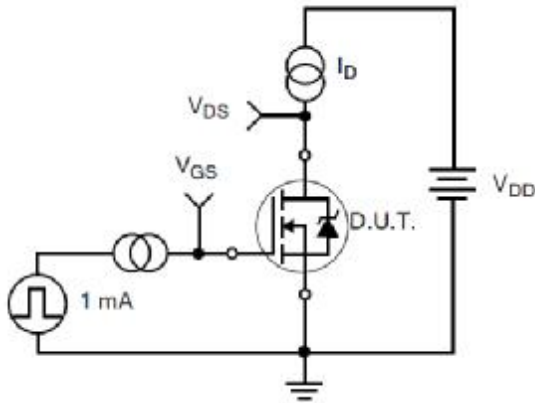

Figure 17. Gate Charge Test Circuit

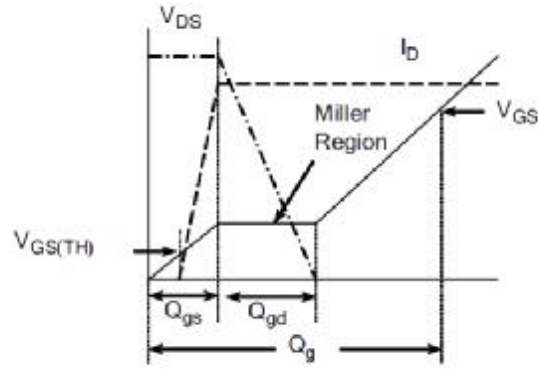

Figure 18. Gate Charge Waveform

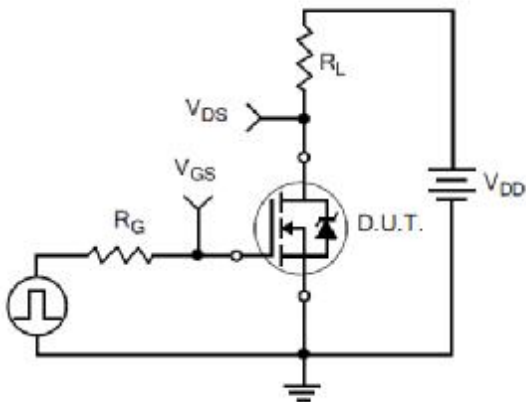

Figure 19. Resistive Switching Test Circuit

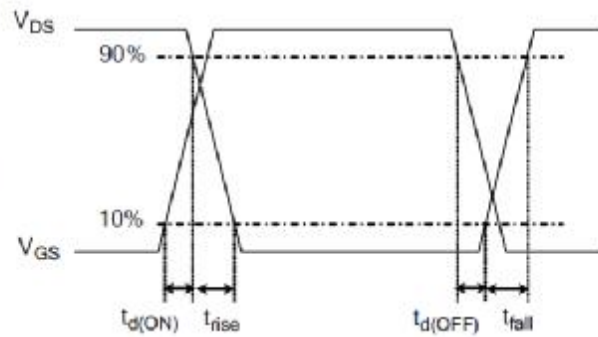

Figure 20. Resistive Switching Waveforms



Figure 21. Diode Reverse Recovery Test Circuit



Figure 22. Diode Reverse Recovery Waveform



Figure 23. Unclamped Inductive Switching Test Circuit

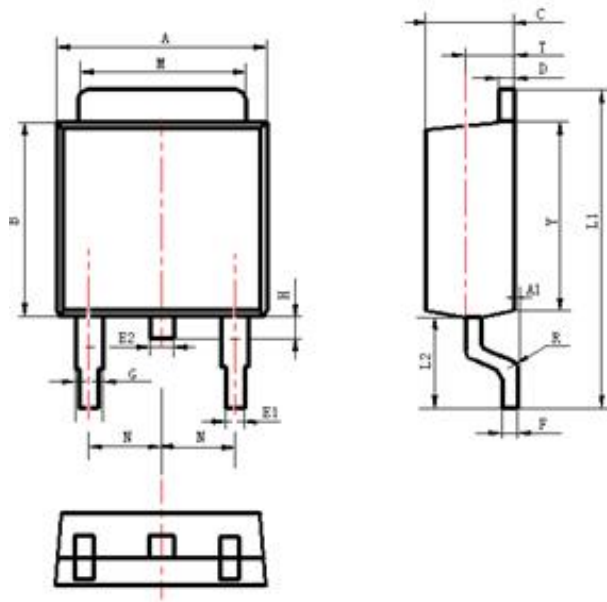

Figure 24. Unclamped Inductive Switching Waveforms

Package Information

Items	Values(mm)	
	MIN	MAX
A	6.30	6.90
A1	0	0.13
B	5.70	6.30
C	2.10	2.50
D	0.30	0.60
E1	0.60	0.90
E2	0.70	1.00
F	0.30	0.60
G	0.70	1.00
L1	9.60	10.30
L2	2.70	3.10
H	0.60	1.00
M	5.10	5.50
N	2.09	2.49
R	0.3	
T	1.40	1.60
Y	5.10	6.30

TO-252 Package



The name and content of poisonous and harmful material in products

Part's Name	Hazardous Substance					
	Pb	Hg	Cd	Cr(VI)	PBB	PBDE
Limit	≤0.1%	≤0.1%	≤0.01%	≤0.1%	≤0.1%	≤0.1%
Lead Frame	○	○	○	○	○	○
Molding Compound	○	○	○	○	○	○
Chip	○	○	○	○	○	○
Wire Bonding	○	○	○	○	○	○
Solder	×	○	○	○	○	○
Note	○: means the hazardous material is under the criterion of SJ/T11363-2006. ×: means the hazardous material exceeds the criterion of SJ/T11363-2006. The plumbum element of solder exist in products presently, but within the allowed range of Eurogroup's RoHS.					

Warnings

1. Exceeding the maximum ratings of the device in performance may cause damage to the device, even the permanent failure, which may affect the dependability of the machine. It is suggested to be used under 80 percent of the maximum ratings of the device.
2. When installing the heatsink, please pay attention to the torsional moment and the smoothness of the heatsink.
3. VDMOSFETs is the device which is sensitive to the static electricity, it is necessary to protect the device from being damaged by the static electricity when using it.
4. This publication is made by Huajing Microelectronics and subject to regular change without notice.

WUXI CHINA RESOURCES HUAJING MICROELECTRONICS CO., LTD.

Add: No.14 Liangxi RD. Wuxi, Jiangsu, China **Mail:**214061 <http://www.crhj.com.cn>
Tel: +86 0510-85807228 **Fax:** +86- 0510-85800864

Marketing Part: **Post:** 214061 **Tel:** +86 0510-81805277/81805336
Fax: +86 0510-85800360/85803016
E-mail: sales@hj.crmicro.com

Application and Service: **Post:** 214061 **Tel / Fax:** +86- 0510-81805243/81805110