

1. FEATURES

- 0V to 76V input common mode
- Low 10 μ V (typ) input offset voltage
- Low 0.1% (max) gain error
- Gain options
 - G = 10V/V (CSA2302-10)
 - G = 20V/V (CSA2302-20)
 - G = 50V/V (CSA2302-50)
 - G = 100V/V (CSA2302-100)
- 8-pin MSOP package

2. APPLICATIONS

- Base stations and communication equipment
- Power management systems
- Server backplanes
- Industrial control and automation

3. DESCRIPTION

The CSA2302 dual-channel high-side current-sense amplifier has precision accuracy specifications of V_{OS} less than 10 μ V (typ) and gain error less than 0.1% (max).

The CSA2302 features an input common-mode voltage range from 0V to 76V with 90kHz of small-signal bandwidth, which makes it ideal for interfacing with a SAR ADC for multichannel multiplexed data acquisition systems.

The CSA2302 operates over the -40°C to 125°C temperature range. The CSA2302 is offered in 8-pin MSOP package. See Table 1 for the order information.

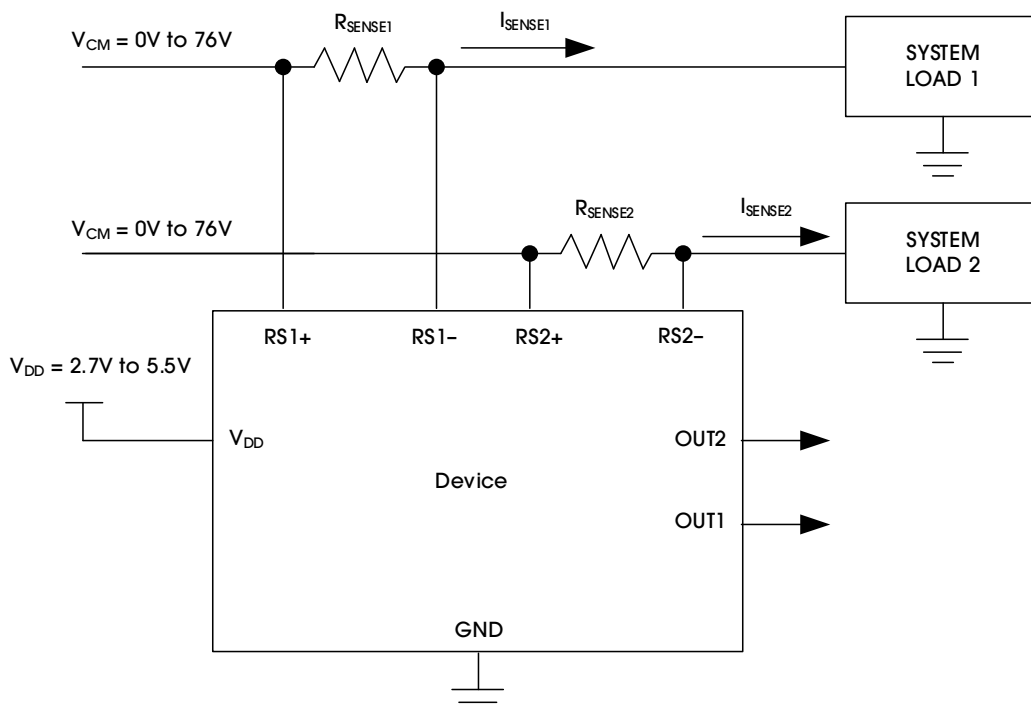

CSA2302

Dual-Channel, High-Voltage, High-Precision, Current-Sense Amplifier

Table 1 lists the order information.

Table 1. Order Information

Order Number ⁽¹⁾	Part Number	CH (#)	Package	Marking	Gain (Typ) (V/V)	Operating Temp (°C)	Package Option
CSA2302LAMSOP8	CSA2302-10	2	MSOP-8	CSA2302L	10	-40-125	T/R-4000
CSA2302MAMSOP8	CSA2302-20	2	MSOP-8	CSA2302M	20	-40-125	T/R-4000
CSA2302NAMSOP8	CSA2302-50	2	MSOP-8	CSA2302N	50	-40-125	T/R-4000
CSA2302PAMSOP8	CSA2302-100	2	MSOP-8	CSA2302P	100	-40-125	T/R-4000

Devices can be ordered via the following two ways:

1. Place orders directly on our website (www.analogsemi.com), or;
2. Contact our sales team by mailing to sales@analogsemi.com.

Note:

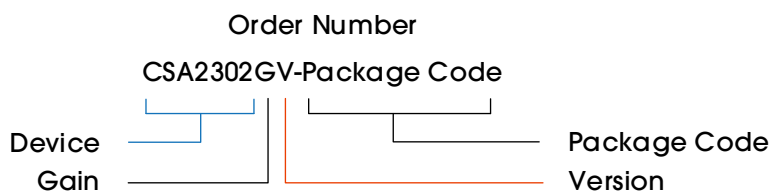

4. PIN CONFIGURATION AND FUNCTIONS

Figure 1 illustrates the pin configuration of the CSA2302.

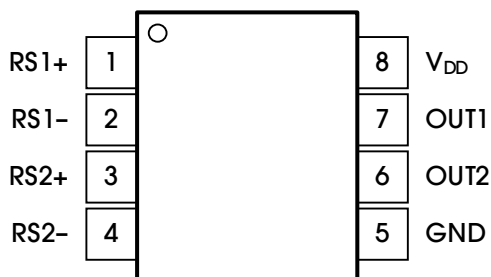

Figure 1. Pin Configuration

Table 2 lists the pin functions of the CSA2302.

Table 2. Pin Functions

POSITION	NAME	TYPE	DESCRIPTION
1	RS1+	Input	Channel 1 external resistor power-side connection
2	RS1-	Input	Channel 1 external resistor load-side connection
3	RS2+	Input	Channel 2 external resistor power-side connection
4	RS2-	Input	Channel 2 external resistor load-side connection
5	GND	Power	Ground
6	OUT2	Output	Output channel 2
7	OUT1	Output	Output channel 1
8	V _{DD}	Power	Supply voltage

5. SPECIFICATIONS

5.1 ABSOLUTE MAXIMUM RATINGS

Table 3 lists the absolute maximum ratings of the CSA2302.

Table 3. Absolute Maximum Ratings

PARAMETER	DESCRIPTION	MIN	MAX	UNITS
Voltage	V _{DD} to GND	-0.3	6.0	V
	RS+, RS- to GND	-0.3	80	
	RS+ to RS-	1s maximum duration due to package thermal dissipation		
Current	Continuous input current (any pin)	-20	20	mA
Temperature	Operating, T _A	-40	125	°C
	Junction, T _J		150	
	Storage, T _{stg}	-65	150	
	Lead (soldering, 10s)		300	
	Soldering (reflow)		260	

Note: Stresses beyond those listed under Table 3 may cause permanent damage to the device. These are stress ratings only, which do not imply functional operation of the device at these or any other conditions beyond those indicated in the operational sections of the specifications. Exposure to absolute-maximum-rated conditions for extended periods may affect device reliability.

5.2 ESD RATINGS

Table 4 lists the ESD ratings of the CSA2302.

Table 4. ESD Ratings

PARAMETER	SYMBOL	DESCRIPTION	VALUE	UNITS
Electrostatic Discharge	V _(ESD)	Human-body model (HBM), per ANSI/ESDA/JEDEC JS-001 ⁽¹⁾	±6000	V
		Charged-device model (CDM), per JEDEC specification JESD22-C101 ⁽²⁾	±1000	

Note 1: The JEDEC document JEP155 indicates that 500V HBM allows safe manufacturing with a standard ESD control process.

Note 2: The JEDEC document JEP157 indicates that 250V CDM allows safe manufacturing with a standard ESD control process.

5.3 THERMAL INFORMATION

Table 5 lists the thermal information for the CSA2302.

Table 5. Thermal Information

PARAMETER	SYMBOL	MSOP-8	UNITS
Junction-to-Ambient Thermal Resistance	R _{θJA}	145	°C/W
Junction-to-Case (Top) Thermal Resistance	R _{θJC(top)}	48.3	°C/W
Junction-to-Board Thermal Resistance	R _{θJB}	83.3	°C/W
Junction-to-Top Characterization Parameter	ψ _{JT}	1.7	°C/W
Junction-to-Board Characterization Parameter	ψ _{JB}	81.7	°C/W
Junction-to-Case (Bottom) Thermal Resistance	R _{θJC(bot)}	85	°C/W

5.4 ELECTRICAL CHARACTERISTICS

Table 6 lists the electrical characteristics of the CSA2302. $V_{RS+} = V_{RS-} = 76V$, $V_{DD} = 3.3V$, $V_{SENSE} = V_{RS+} - V_{RS-} = 1mV$, $T_A = -40^{\circ}C$ to $125^{\circ}C$, unless otherwise noted. Typical values are at $T_A = 25^{\circ}C$.⁽¹⁾

Table 6. Electrical Characteristics

PARAMETER	SYMBOL	CONDITIONS	MIN	TYP	MAX	UNITS
DC CHARACTERISTICS						
Supply Voltage	V_{DD}	Guaranteed by PSRR	2.7		5.5	V
Supply Current	I_{DD}	$T_A = 25^{\circ}C$		1021	1300	μA
		$-40^{\circ}C < T_A < 125^{\circ}C$			1300	
Power-Supply Rejection Ratio	PSRR	$2.7V \leq V_{DD} \leq 5.5V$	105	123		dB
Input Common-Mode Voltage Range	V_{CM}	Guaranteed by CMRR	0		76	V
Input Bias Current at V_{RS+} and V_{RS-} ⁽²⁾	I_{RS+}, I_{RS-}	$V_{SENSE} = 0V$		5	20	nA
Input Offset Current ⁽²⁾	$I_{RS+} - I_{RS-}$	$V_{SENSE} = 0V$		5	20	nA
Input Leakage Current	I_{RS+}, I_{RS-}	$V_{DD} = 0V, V_{RS+} = V_{RS-} = 76V$		0.005	0.2	μA
Common-Mode Rejection Ratio	CMRR	$0V < V_{RS+} < 76V$	125	155		dB
Input Offset Voltage ⁽²⁾⁽³⁾	V_{OS}	$T_A = 25^{\circ}C$		± 10	± 60	μV
		$-40^{\circ}C \leq T_A \leq 125^{\circ}C$		± 30	± 100	
Input Offset Voltage Drift ⁽²⁾	TCV_{OS}			200		nV/ $^{\circ}C$
Input Sense Voltage	V_{SENSE}			V_{OH} / G		mV
Gain ⁽³⁾	G	CSA2302-10		10		V/V
		CSA2302-20		20		
		CSA2302-50		50		
		CSA2302-100		100		
Gain Error ⁽²⁾	GE	$T_A = 25^{\circ}C$		0.02	0.1	%
		$-40^{\circ}C \leq T_A \leq 125^{\circ}C$		0.08	0.3	
Output Low Voltage	V_{OL}	Sink 500 μA			10	mV
		No load			4	
Output High Voltage	V_{OH}	Source 500 μA	$V_{DD} - 0.010$			V
AC CHARACTERISTICS						
Signal Bandwidth	BW -3dB	All gain configurations $V_{SENSE} > 5mV$		90		kHz
AC Power-Supply Rejection Ratio	AC PSRR	$f = 200kHz$		43		dB
AC CMRR	AC CMRR	$f = 200kHz$		71		dB
Capacitive Load Stability	C_{LOAD}	With 250 Ω isolation resistor		20		nF
		Without any isolation resistor		500		pF
Input Voltage-Noise Density	e_n	$f = 1kHz$		58		nV/ \sqrt{Hz}
Power-Up Time ⁽⁴⁾				80		μs
Saturation Recovery Time				5		μs

Note 1: All devices are 100% production tested at $T_A = 25^{\circ}C$. All temperature limits are guaranteed by design.

Note 2: Specifications are guaranteed by design, not production tested.

Note 3: Gain and offset voltage are calculated based on two-point measurements: V_{SENSE1} and V_{SENSE2} .

$$V_{SENSE1} = 20\% \times \text{Full-Scale } V_{SENSE}, V_{SENSE2} = 80\% \times \text{Full-Scale } V_{SENSE}.$$

Note 4: Output is high-Z during power-up.

5.5 TYPICAL CHARACTERISTICS

$V_{RS+} = V_{RS-} = 76V$, $V_{DD} = 3.3V$, $V_{SENSE} = V_{RS+} - V_{RS-} = 1mV$, $T_A = 25^{\circ}C$, unless otherwise noted.

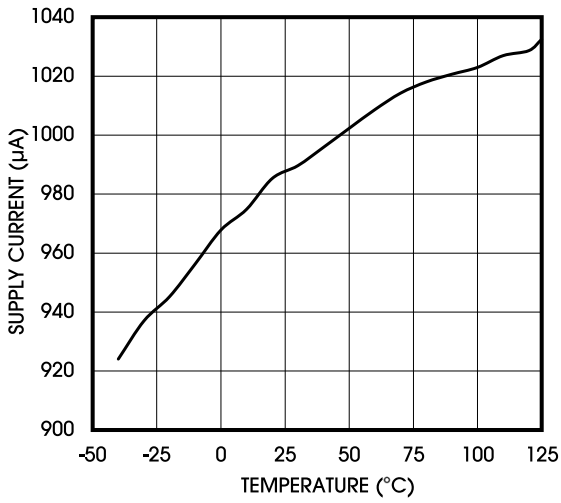

Figure 2. Supply Current vs Temperature

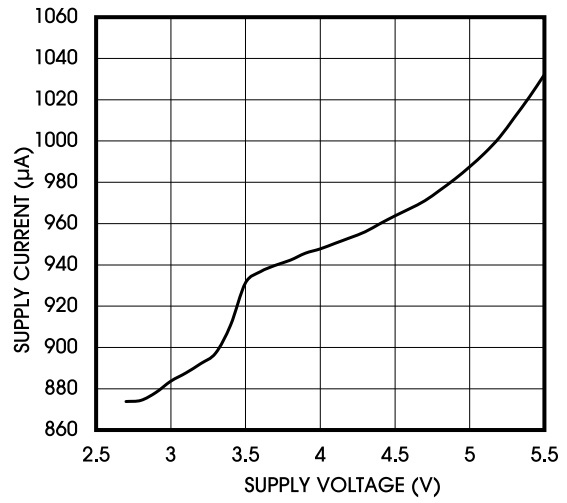

Figure 3. Supply Current vs Supply Voltage

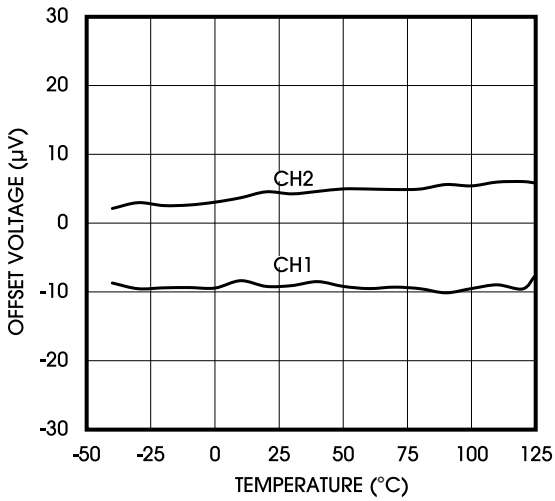

Figure 4. Input Offset Voltage vs Temperature

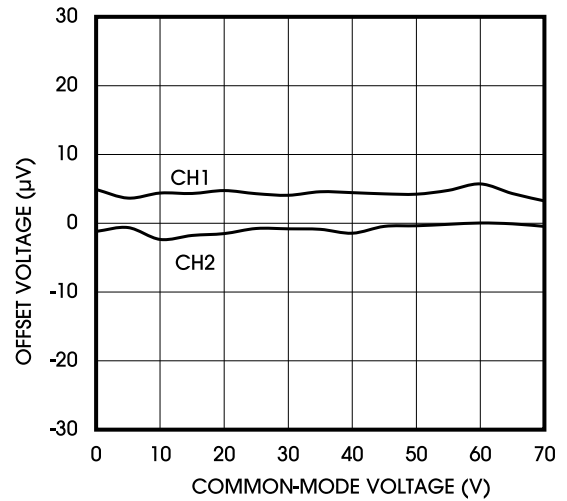

Figure 5. Input Offset Voltage vs Input Common Mode Voltage

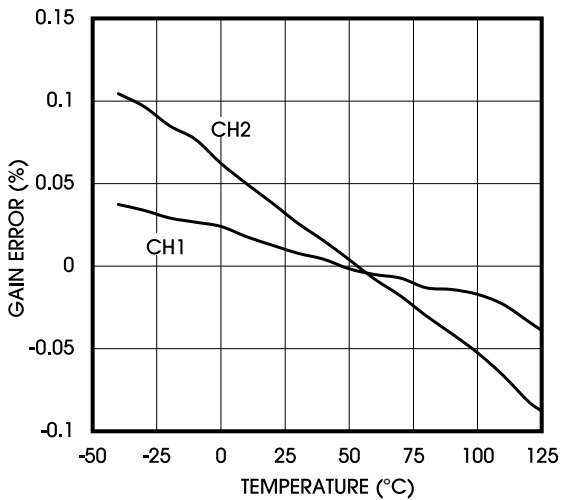

Figure 6. Gain Error vs Temperature

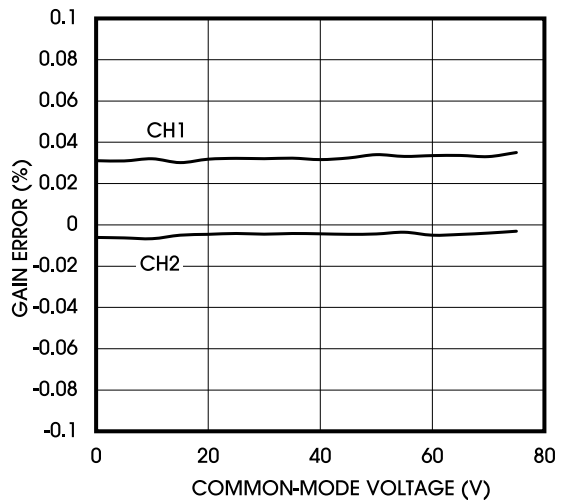

Figure 7. Gain Error vs Common Mode Voltage

5.6 TYPICAL CHARACTERISTICS (CONTINUED)

$V_{RS+} = V_{RS-} = 76V, V_{DD} = 3.3V, V_{SENSE} = V_{RS+} - V_{RS-} = 1mV, T_A = 25^\circ C$, unless otherwise noted.

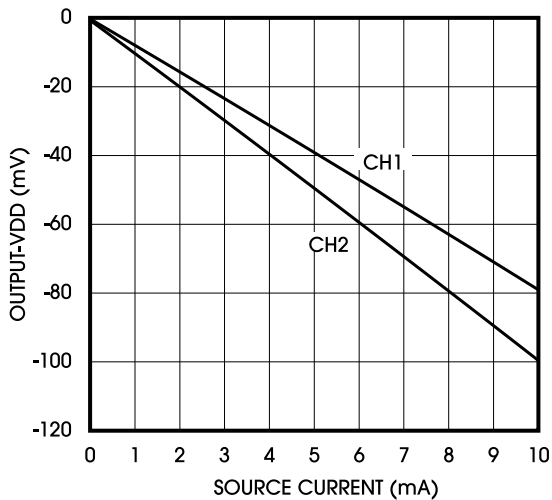

Figure 8. V_{OH} vs Source Current

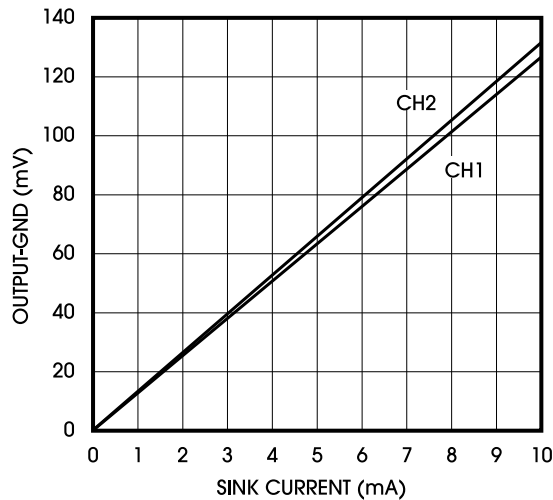

Figure 9. V_{OL} vs Sink Current

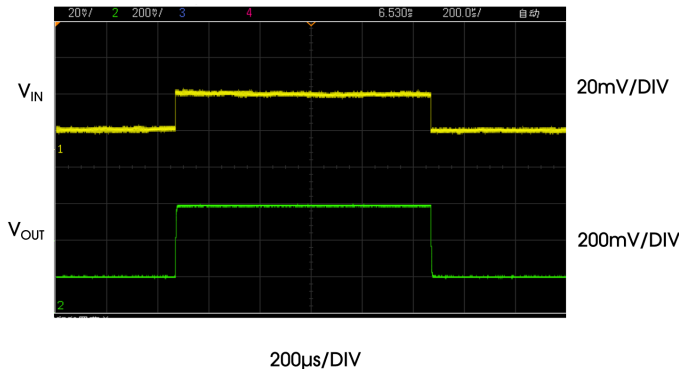

Figure 10. Small Signal Step Response

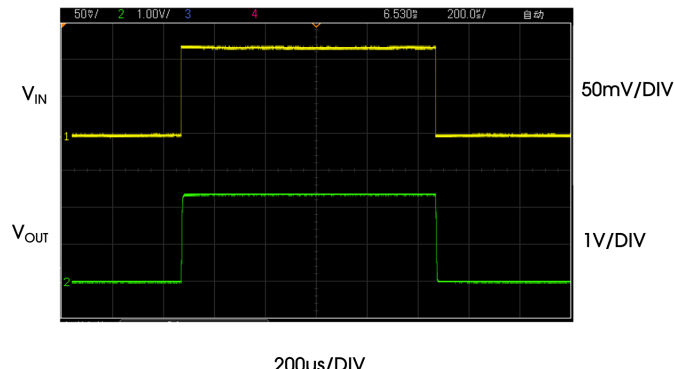

Figure 11. Large Signal Step Response

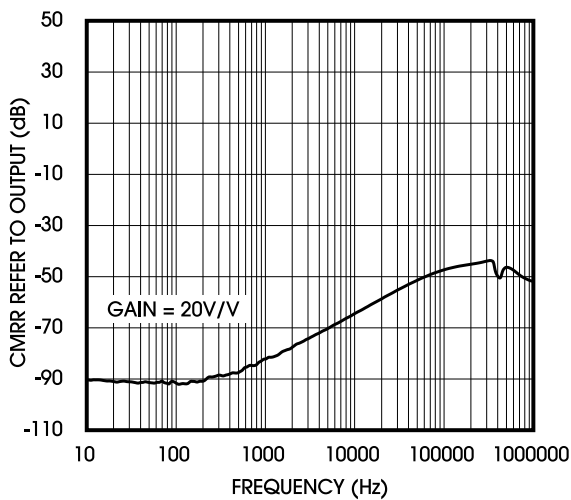

Figure 12. CMRR Referred to Output vs Frequency

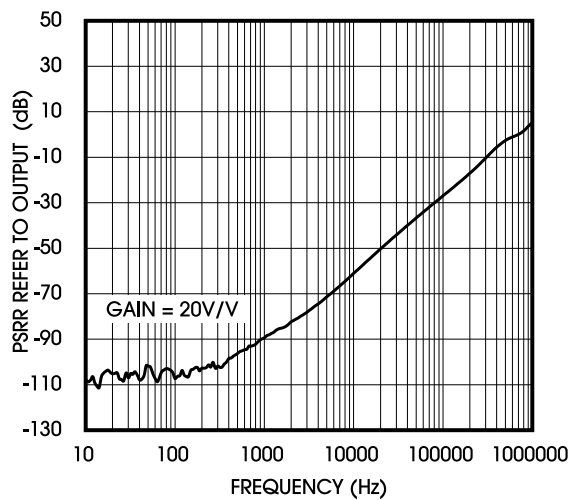

Figure 13. PSRR Referred to Output vs Frequency

5.7 TYPICAL CHARACTERISTICS (CONTINUED)

$V_{RS+} = V_{RS-} = 76V$, $V_{DD} = 3.3V$, $V_{SENSE} = V_{RS+} - V_{RS-} = 1mV$, $T_A = 25^{\circ}C$, unless otherwise noted.

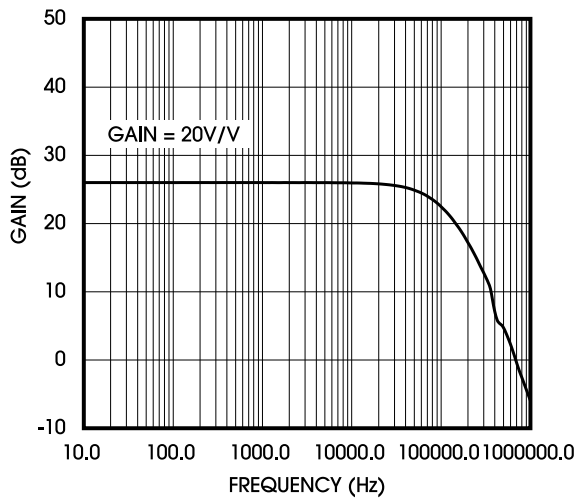

Figure 14. Gain vs Frequency

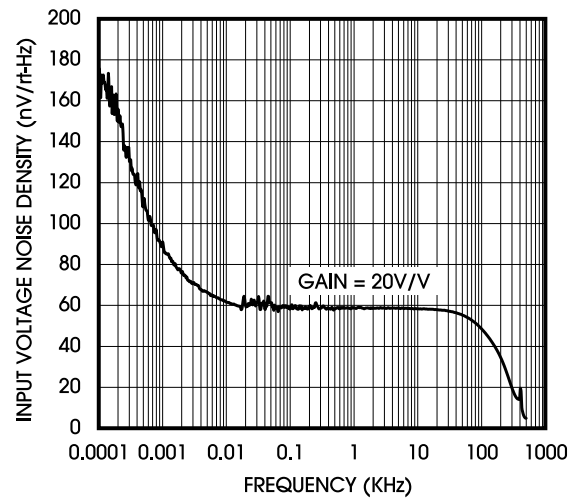

Figure 15. Input Voltage Noise Density vs Frequency

6. DETAILED DESCRIPTION

6.1 OVERVIEW

The CSA2302 high-side, current-sense amplifier features a 0V to 76V input common-mode range that is independent of supply voltage. This feature allows the monitoring of current out of a battery as low as 0V and enables high-side current sensing at voltages greater than the supply voltage (V_{DD}). The CSA2302 monitors current through a current-sense resistor and amplifies the voltage across the resistor.

High-side current monitoring does not interfere with the ground path of the load being measured, making the CSA2302 particularly useful in a wide range of high-voltage systems.

6.2 FUNCTIONAL BLOCK DIAGRAM

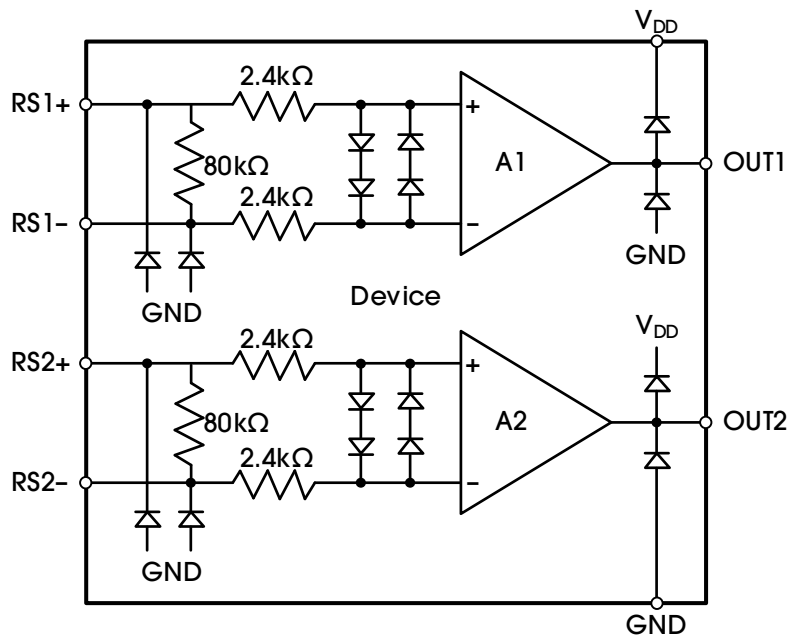

Figure 16. Functional Block Diagram

7. APPLICATION AND IMPLEMENTATION

NOTE

The information provided in this section is not part of the Analogyssemi component specification. Hence, Analogyssemi does not warrant its completeness or accuracy. Customers are responsible for determining suitability of components and system functionality for their applications. Validation and testing should be performed prior to design implementation.

7.1 APPLICATION INFORMATION

7.1.1 RECOMMENDED COMPONENT VALUES

Ideally, the maximum load current develops the full-scale sense voltage across the current-sense resistor. Power V_{DD} with typical 3.3V, and choose the gain needed to yield the maximum output voltage required for the application:

$$V_{OUT} = V_{SENSE} \times A_V$$

Where V_{SENSE} is the full-scale sense voltage, 330mV for gain of 10V/V, 165mV for gain of 20V/V, 66mV for gain of 50V/V, 33mV for gain of 100V/V, and A_V is the gain of the device.

In applications monitoring a high current, ensure that R_{SENSE} is able to dissipate its own I^2R loss. If the resistor's power dissipation exceeds the nominal value, its value may drift or it may fail altogether. The CSA2302 senses a wide variety of currents with different sense-resistor values.

7.1.2 CHOOSING THE SENSE RESISTOR

Choose R_{SENSE} based on the following criteria:

- **Voltage Loss:** A high R_{SENSE} value causes the power-source voltage to degrade through IR loss. For minimal voltage loss, use the lowest R_{SENSE} value.
- **Accuracy:** A high R_{SENSE} value allows lower currents measured more accurately. This is due to offsets becoming less significant when the sense voltage is larger. For best performance, while using 3.3V for V_{DD} , select R_{SENSE} to provide approximately 330mV (gain of 10V/V), 165mV (gain of 20V/V), or 66mV (gain of 50V/V), 33mV (gain of 100V/V) of sense voltage for the full-scale current in each application.
- **Efficiency and Power Dissipation:** At high current levels, the I^2R losses in R_{SENSE} can be significant. Consider this when choosing the resistor value and its power dissipation (wattage) rating. In addition, the sense resistor's value might drift if it heats up excessively.
- **Inductance:** Keep inductance low if I_{SENSE} has a large high-frequency component. Wire-wound resistors have the highest inductance, while metal film is somewhat better. Low-inductance, metal-film resistors are also available. Instead of being spiral wrapped around a core, as in metal-film or wire wound resistors, they are a straight band of metal and are available in values under 1Ω.

Take care to eliminate parasitic trace resistance from causing errors in the sense voltage because of the high currents that flow through R_{SENSE} . Either use a four-terminal current-sense resistor or use Kelvin (force and sense) PCB layout techniques.

7.2 POWER-SUPPLY BYPASSING

Power-supply bypass capacitors are recommended for best performance and should be placed as close as possible to the supply and ground terminals of the device. A typical value for this supply bypass capacitor is 0.1 μ F (NP0/C0G type) close to the V_{DD}/GND pins. The capacitors should be rated for at least twice the maximum expected applied voltage. Applications with noisy or high-impedance power supplies may require additional decoupling capacitors to reject power-supply noise.

7.2.1 BASE STATION APPLICATION CIRCUIT

An example of a typical application (Figure 17) of this high-voltage, high-precision current-sense amplifier is in base-station systems where there is a need to monitor the current flowing in the power amplifier. Such amplifiers, depending on the technology, can be biased up to 50V or 60V, thus requiring a current-sense amplifier like the CSA2302 with high-voltage common mode. The very low input offset voltage of the CSA2302 minimizes the value of the external sense resistor, thus resulting in system power-saving.

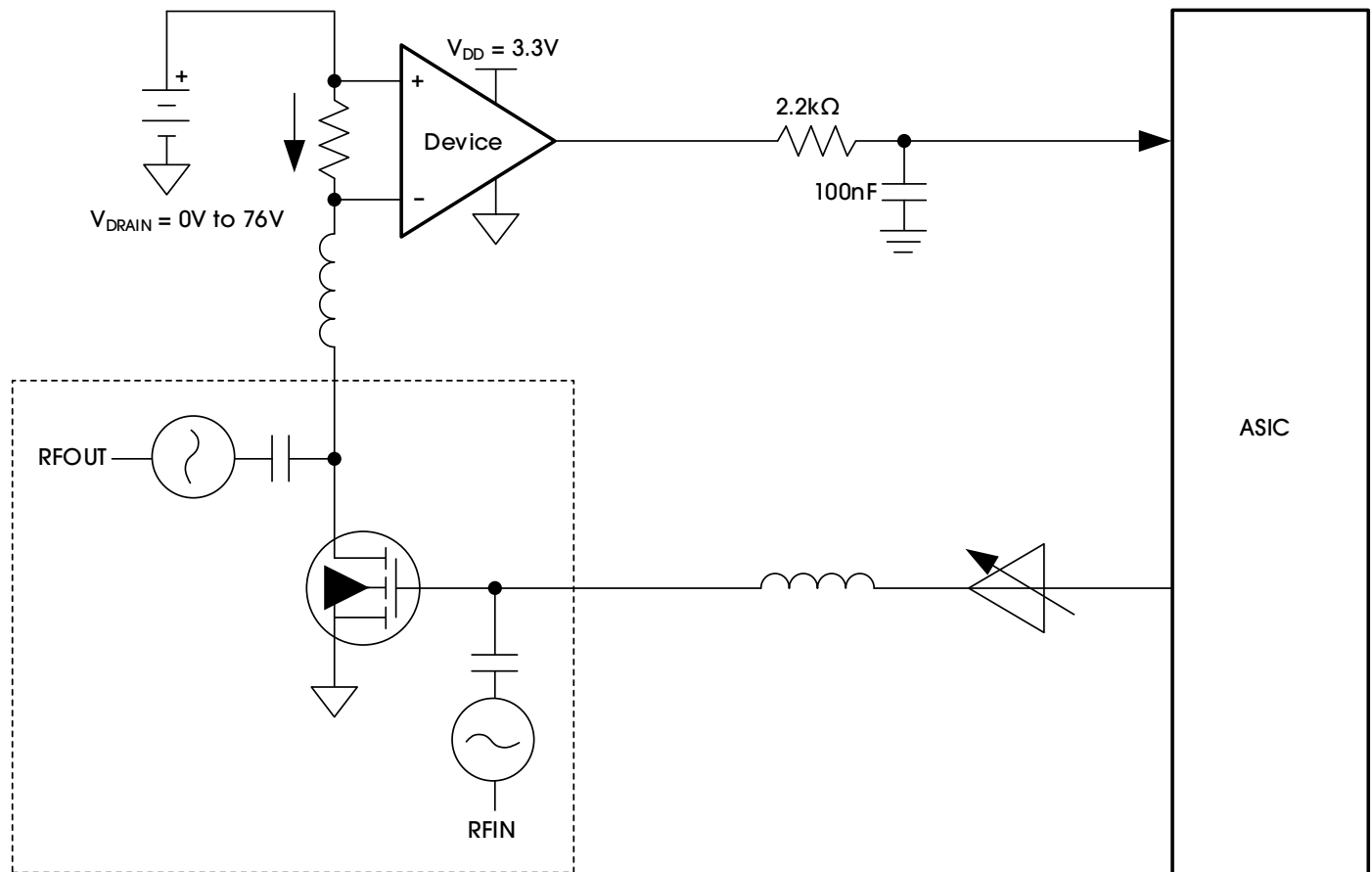

Figure 17. CSA2302 Used in Base-Station Application

8. PACKAGE INFORMATION

The CSA2302 is available in the MSOP-8 packages. Figure 18 shows the package view.

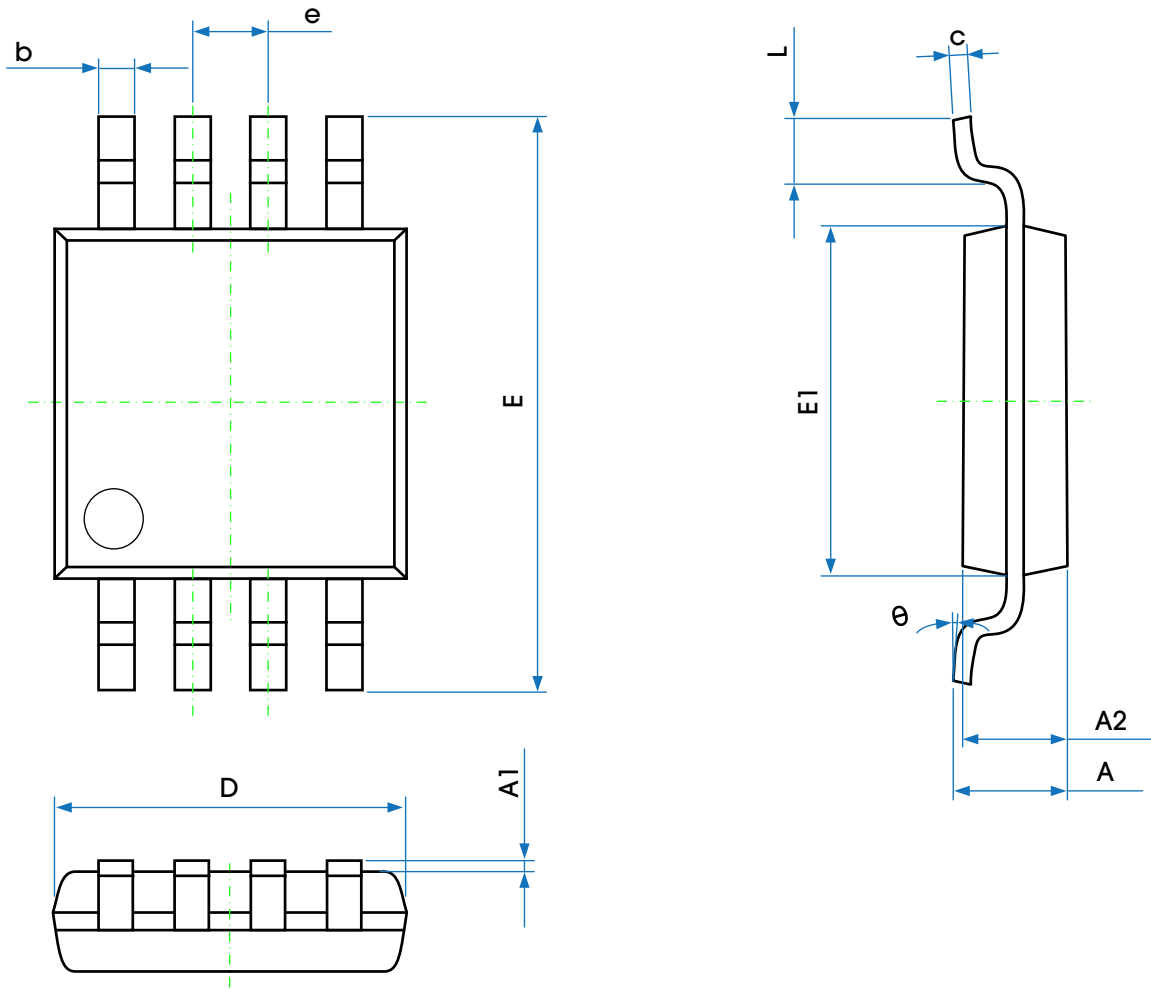

Figure 18. Package View

Table 7 provides detailed information about the dimensions.

Table 7. Dimensions

SYMBOL	DIMENSIONS IN MILLIMETERS		DIMENSIONS IN INCHES	
	MIN	MAX	MIN	MAX
A	—	1.100	—	0.043
A1	0.020	0.150	0.001	0.006
A2	0.750	0.950	0.030	0.037
b	0.250	0.380	0.010	0.015
c	0.090	0.230	0.004	0.009
D	2.900	3.100	0.114	0.122
e	0.650 (BSC)		0.026 (BSC)	
E	4.750	5.050	0.187	0.199
E1	2.900	3.100	0.114	0.122
L	0.400	0.800	0.016	0.031
θ	0°	6°	0°	6°

9. TAPE AND REEL INFORMATION

Figure 19 illustrates the carrier tape.

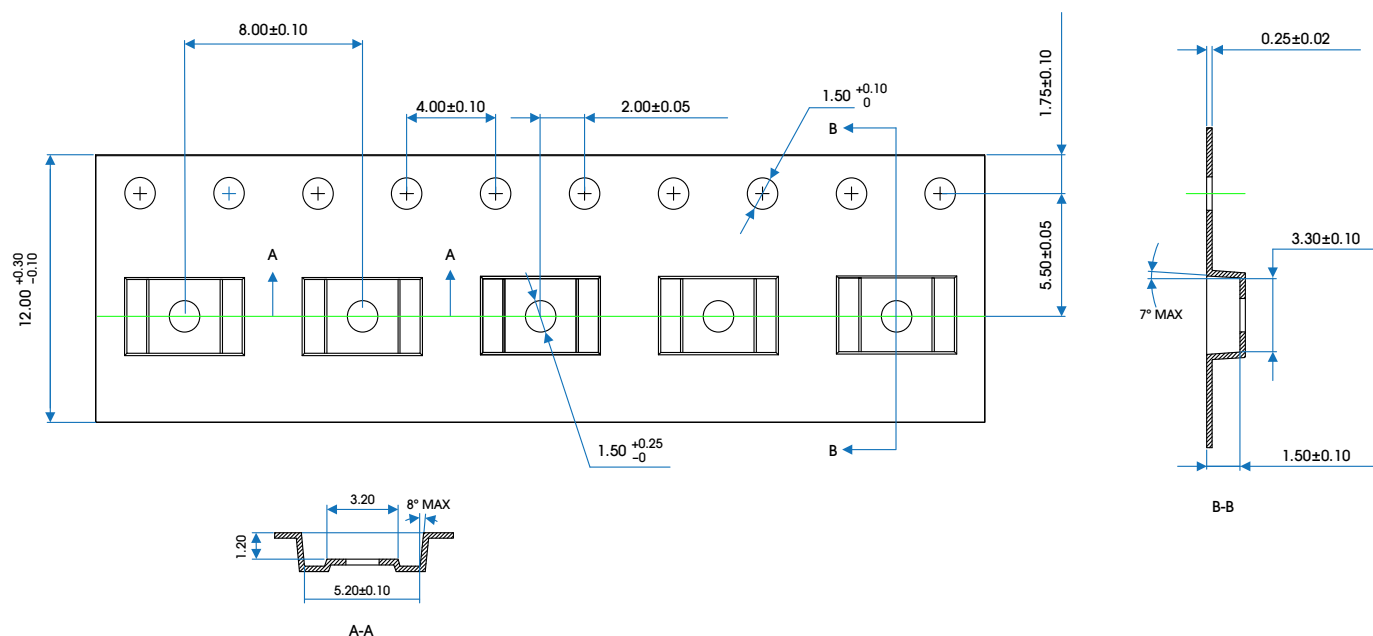

Notes:

1. Cover tape width: 9.5 ± 0.10 .
2. Cumulative tolerance of 10 sprocket hole pitch: ± 0.20 (max).
3. Camber: not to exceed 1mm in 100mm.
4. Mold#: MSOP-8.
5. All dimensions: mm.
6. Direction of view:

Figure 19. Carrier Tape Drawing

Table 8 provides information about tape and reel.

Table 8. Tape and Reel Information

PACKAGE TYPE	REEL	QTY/REEL	REEL/ INNER BOX	INNER BOX/ CARTON	QTY/CARTON	INNER BOX SIZE (MM)	CARTON SIZE (MM)
MSOP-8	13"	4000	1	8	32000	358*340*50	430*380*390

Figure 20 shows the product loading orientation—pin 1 is assigned on the upper left corner.

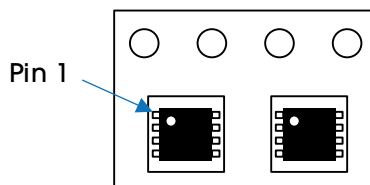

Figure 20. Product Loading Orientation

CSA2302

Dual-Channel, High-Voltage, High-Precision, Current-Sense Amplifier

REVISION HISTORY

REVISION	DATE	DESCRIPTION
Rev A	01 April 2022	Rev A release.