



Spec. No.	PS-DD-S40228/S40229A9
Rev.	A

PRODUCT SPECIFICATION

Model No:CSD-S40228A9/S40229A9

Descriptions:

- 0.4 Inch Dual Digit SMD Display
- Emitting Color : Super Bright Amber



CUSTOMER APPROVED SIGNATURES	APPROVED BY	CHECKED BY	PREPARED BY

CHINA SEMICONDUCTOR CORPORATION
Address:2FL. NO.909,Chung-Cheng Road,
Chung-Ho City Taipei Hsien,Taiwan.

Tel:886-2-2223-9696
Fax:886-2-2223-9377

OPTO PLUS TECHNOLOGIES CO.,LTD
Address:696 Shun jiang Rd.,Ji Shan St.Shaoxing,
ZheJiang,China

Tel:86-0575-88623888
Fax:86-0575-88623112

Model No : CSD-S40228/S40229A9

Features -

1. 0.4 inch (10.16mm) digit height.
2. Qualified according to JEDEC moisture sensitivity Level 2a.
3. RoHS compliant.
4. Low power consumption.
5. Easy mounting on P.C. board.

Device Selection Guide -

Model No.	Chip		Description
	Material	Emitting Color	
CSD-S40228A9	AlGaInP	Super Bright Amber	Common Anode
CSD-S40229A9	AlGaInP	Super Bright Amber	Common Cathode

Mechanical Dimensions -

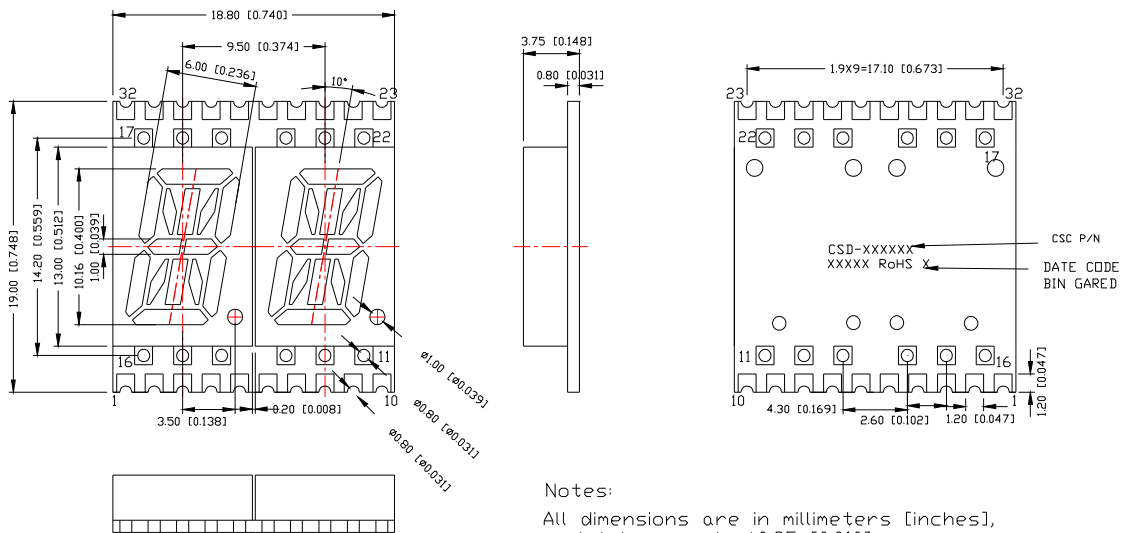

Model No : CSD-S40228/S40229A9

Internal Circuit Diagrams -

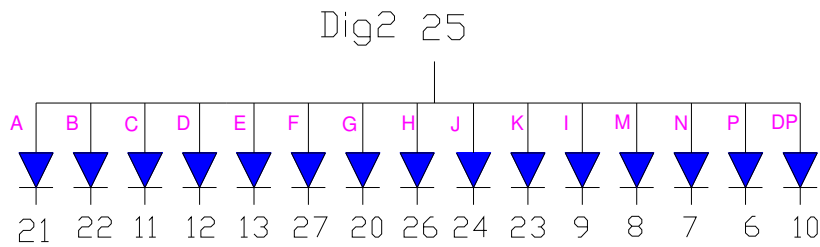
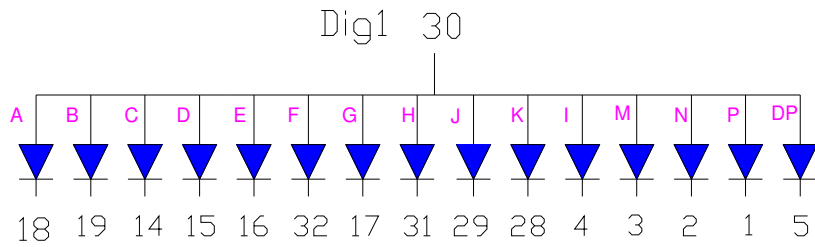
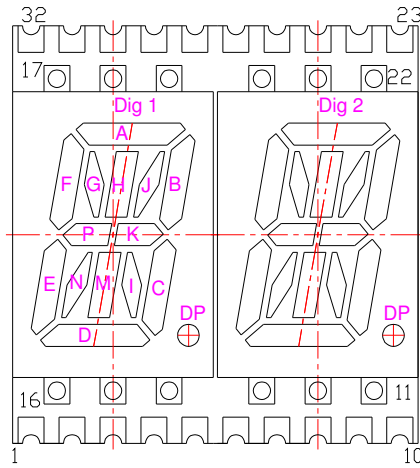



Spec. No.	PS-DD-S40228/S40229A9
Rev.	A

Model No : CSD-S40228/S40229A9
■ Absolute Maximum Rating -

(Ta=25°C)

Parameter	Symbol	Rating	Unit
Power Dissipation Per Dice	P_{AD}	70	mW
Continuous Forward Current Per Dice	I_{AF}	25	mA
Peak Current Per Dice(duty cycle 1/10,1KHz)	I_{PF}	90	mA
Derating Linear From 25°C Per Dice	-	0.33	mA/°C
Reverse Voltage Per Dice	V_R	5	V
Operating Temp.	T_{opr}	-40 ~ +105	°C
Storage Temp.	T_{stg}	-40 ~ +105	°C

■ Electro-optical Characteristics -

(Ta=25°C)

Parameter	Symbol	Min.	Typ.	Max.	Unit	Condition
Forward Voltage Per Segment	V_F	-	2.0	2.8	V	I _F =20mA
Luminous Intensity Per Segment	I_v	6	15	-	mcd	I _F =10mA
Peak Emission Wavelength	λ_P	-	612	-	nm	I _F =20mA
Spectrum Radiation Bandwidth	Δλ	-	20	-	nm	I _F =20mA
Reverse Current	I_R	-	-	100	μA	V _R =5V
Luminous Intensity Matching Ratio	I_{V-m}	-	-	2:1	-	I _F =10mA

Model No : CSD-S40228/S40229A9

■ Typical Electrical / Optical Characteristics Curves -

(Ta = 25°C Unless Otherwise Noted)

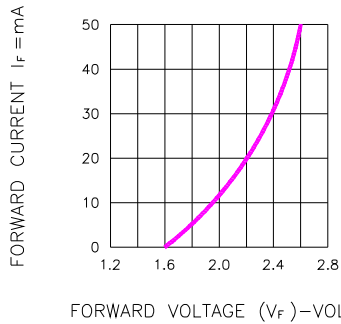

Fig.1 FORWARD CURRENT VS. FORWARD VOLTAGE

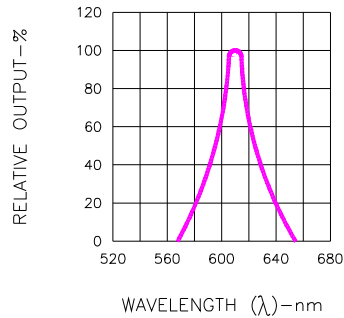

Fig.2 SPECTRAL RESPONSE

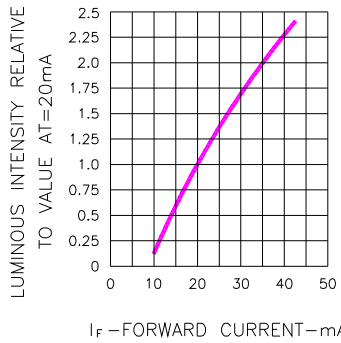

Fig.3 RELATIVE LUMINOUS INTENSITY VS. FORWARD CURRENT

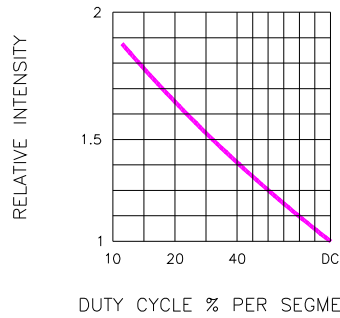

Fig.5 LUMINOUS INTENSITY VS. DUTY CYCLE

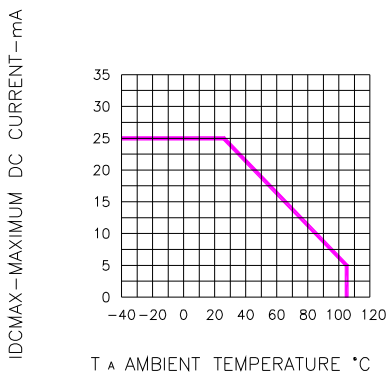

Fig.4 MAXIMUM ALLOWABLE DC CURRENT PER SEGMENT VS. A FUNCTION OF AMBIENT TEMPERATURE

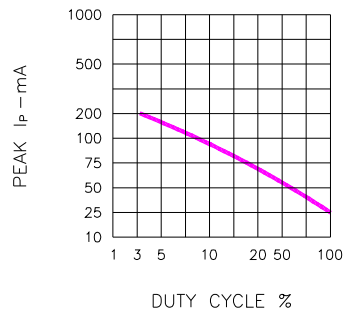
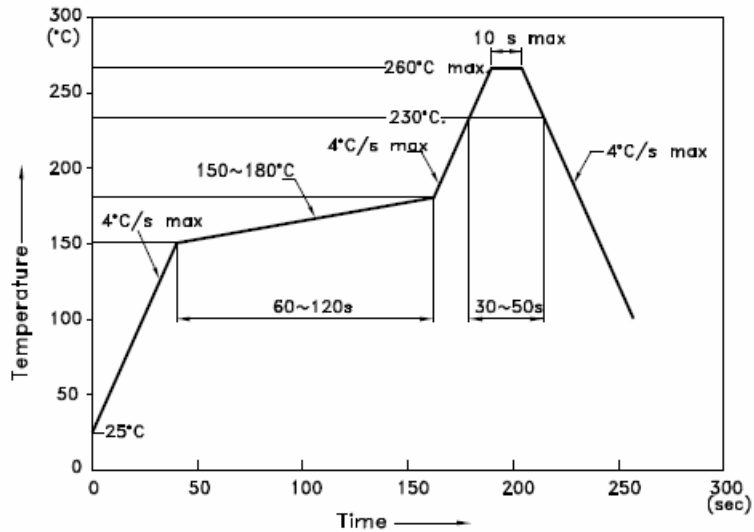

Fig.6 MAX PEAK CURRENT VS. DUTY CYCLE (REFRESH RATE f=1 KHz)

Model No : CSD-S40228/S40229A9

SMT REFLOW SOLDERING INSTRUCTIONS

■ IR Reflow Temperature / Time :



NOTES:

1. We recommend the reflow temperature 245°C(+/-5°C). The maximum soldering temperature should be limited to 260°C.
2. Don't cause stress to the epoxy resin while it is exposed to high temperature.
3. Number of reflow process shall be 2 times or less.

■ Soldering Pad Size

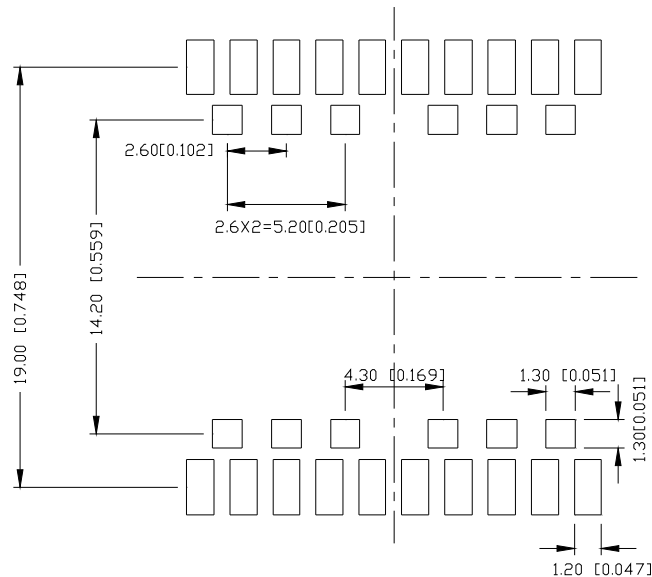



Spec. No.	PS-DD-S40228/S40229A9
Rev.	A

Model No : CSD-S40228/S40229A9

REEL DIMENSIONS

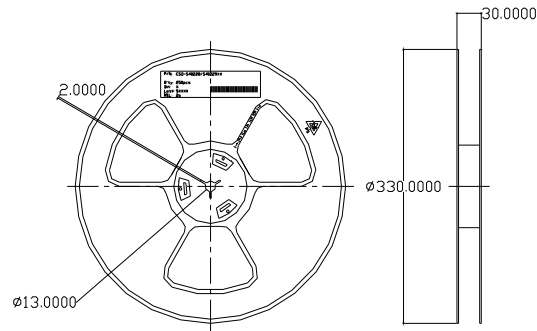

PACKING & LABEL SPECIFICATIONS

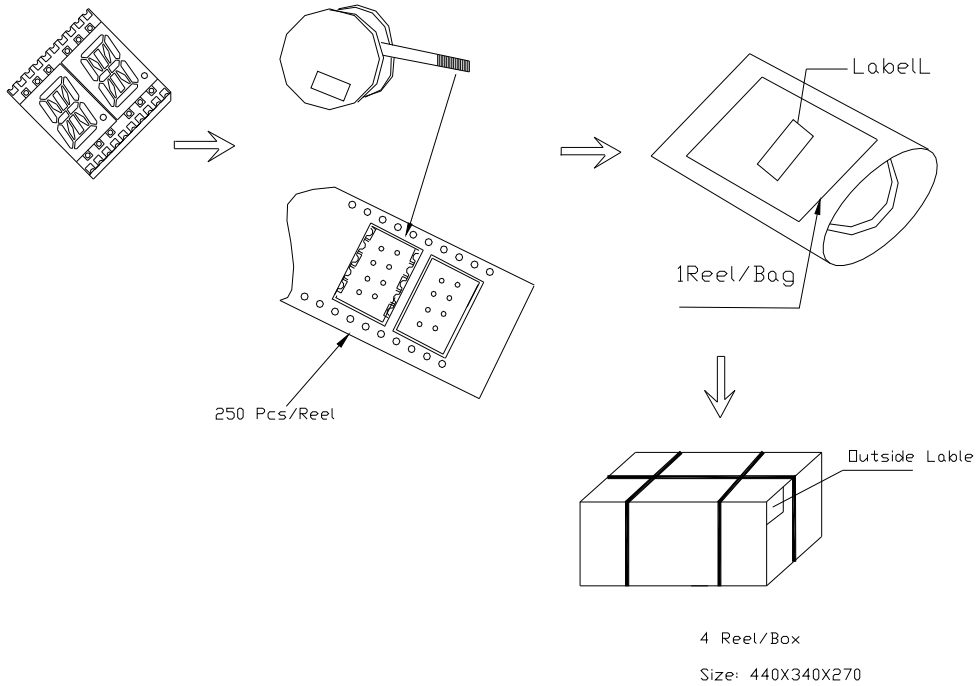

Note: The specifications are subject to change without notice. Please contact us for updated information.