



Spec. No.	PS-DD-S40228/S40229M9
Rev.	A

# PRODUCT SPECIFICATION

**Model No:CSD-S40228M9/S40229M9**

## Descriptions:

- 0.4 Inch Dual Digit SMD Display
- Emitting Color : Super Bright Green



CUSTOMER APPROVED SIGNATURES	APPROVED BY	CHECKED BY	PREPARED BY

**CHINA SEMICONDUCTOR CORPORATION**  
Address:2FL. NO.909,Chung-Cheng Road,  
Chung-Ho City Taipei Hsien,Taiwan.

Tel:886-2-2223-9696  
Fax:886-2-2223-9377

**OPTO PLUS TECHNOLOGIES CO.,LTD**  
Address:696 Shun jiang Rd.,Ji Shan St.Shaoxing,  
ZheJiang,China

Tel:86-0575-88623888  
Fax:86-0575-88623112

<b>Spec. No.</b>	PS-DD-S40228/S40229M9
<b>Rev.</b>	A

**Model No : CSD-S40228/S40229M9**

**Features -**

1. 0.4 inch (10.16mm) digit height.
2. Qualified according to JEDEC moisture sensitivity Level 2a.
3. RoHS compliant.
4. Low power consumption.
5. Easy mounting on P.C. board.

**Device Selection Guide -**

Model No.	Chip		Description
	Material	Emitting Color	
CSD-S40228M9	AlGaInP	Super Bright Green	Common Anode
CSD-S40229M9	AlGaInP	Super Bright Green	Common Cathode

**Mechanical Dimensions -**

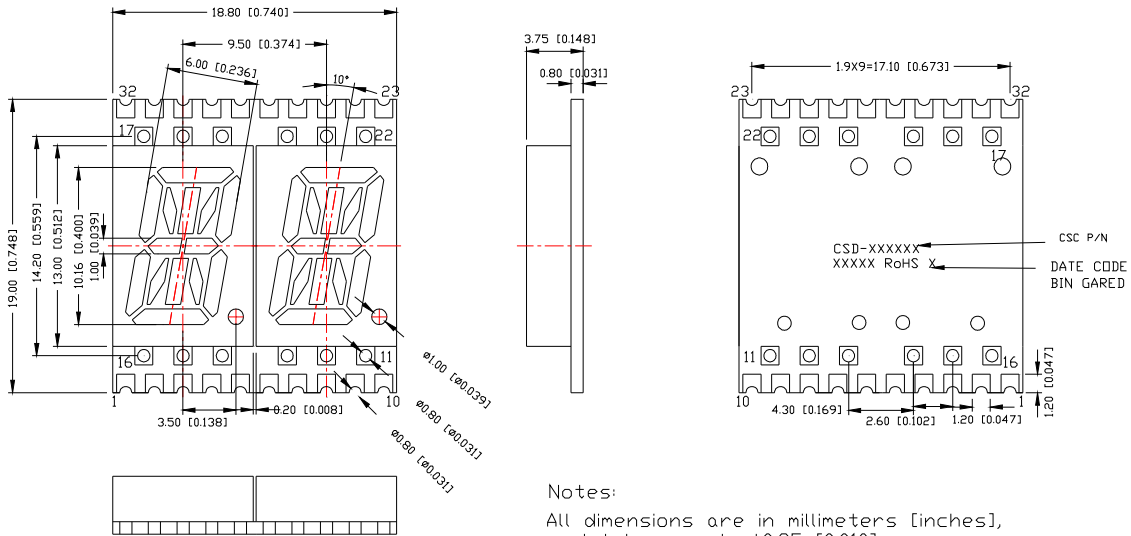

Notes:  
All dimensions are in millimeters [inches],  
and tolerance is  $\pm 0.25$  [0.010]  
unless otherwise noted.

Model No : CSD-S40228/S40229M9

Internal Circuit Diagrams -

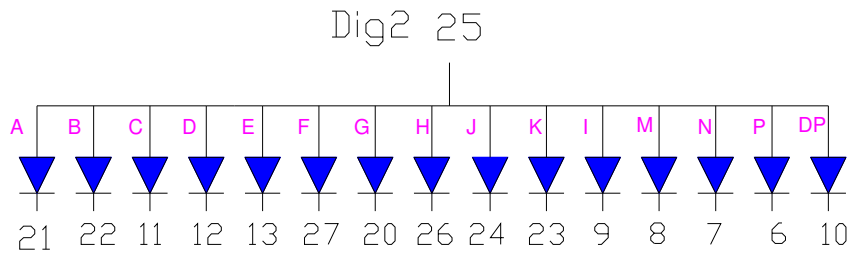
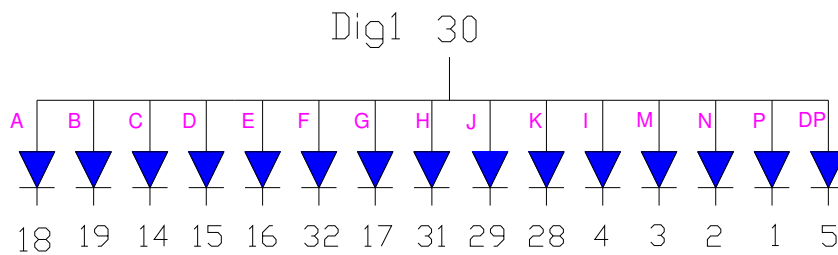
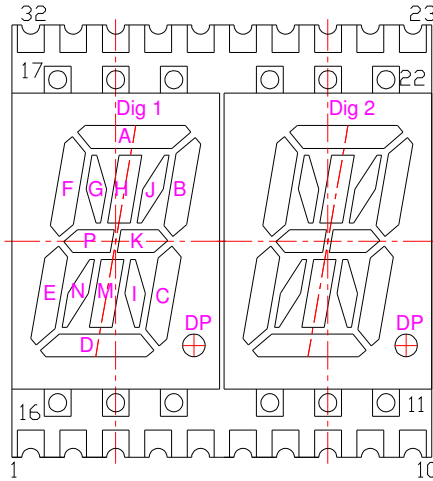



<b>Spec. No.</b>	PS-DD-S40228/S40229M9
<b>Rev.</b>	A

**Model No : CSD-S40228/S40229M9**
**■ Absolute Maximum Rating -**

(Ta=25°C)

Parameter	Symbol	Rating	Unit
Power Dissipation Per Dice	<b>P<sub>AD</sub></b>	70	mW
Continuous Forward Current Per Dice	<b>I<sub>AF</sub></b>	25	mA
Peak Current Per Dice(duty cycle 1/10,1KHz)	<b>I<sub>PF</sub></b>	90	mA
Derating Linear From 25°C Per Dice	-	0.33	mA/°C
Reverse Voltage Per Dice	<b>V<sub>R</sub></b>	5	V
Operating Temp.	<b>T<sub>opr</sub></b>	-40 ~ +105	°C
Storage Temp.	<b>T<sub>stg</sub></b>	-40 ~ +105	°C

**■ Electro-optical Characteristics -**

(Ta=25°C)

Parameter	Symbol	Min.	Typ.	Max.	Unit	Condition
Forward Voltage Per Segment	<b>V<sub>F</sub></b>	-	2.1	2.8	V	I <sub>F</sub> =20mA
Luminous Intensity Per Segment	<b>I<sub>v</sub></b>	4	10	-	mcd	I <sub>F</sub> =10mA
Peak Emission Wavelength	<b>λ<sub>P</sub></b>	-	572	-	nm	I <sub>F</sub> =20mA
Dominant Wavelength	<b>λ<sub>d</sub></b>	-	570	-	nm	I <sub>F</sub> =20mA
Spectrum Radiation Bandwidth	<b>Δλ</b>	-	20	-	nm	I <sub>F</sub> =20mA
Reverse Current	<b>I<sub>R</sub></b>	-	-	100	μA	V <sub>R</sub> =5V
Luminous Intensity Matching Ratio	<b>I<sub>V-m</sub></b>	-	-	2:1	-	I <sub>F</sub> =10mA

**Model No : CSD-S40228/S40229M9**

**Typical Electrical / Optical Characteristics Curves -**

( $T_a = 25^\circ\text{C}$  Unless Otherwise Noted)

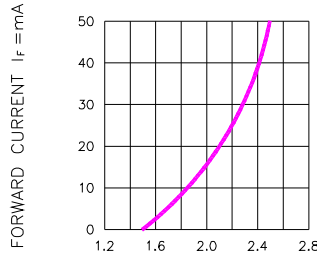

Fig.1 FORWARD CURRENT VS. FORWARD VOLTAGE

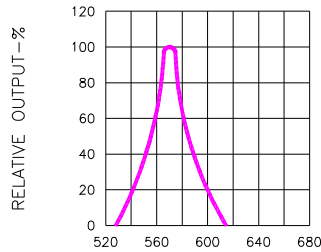

Fig.2 SPECTRAL RESPONSE

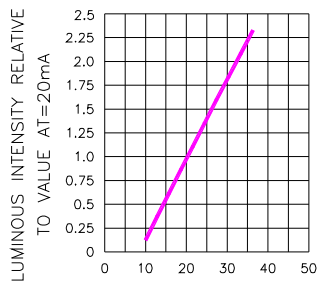

Fig.3 RELATIVE LUMINOUS INTENSITY VS. FORWARD CURRENT

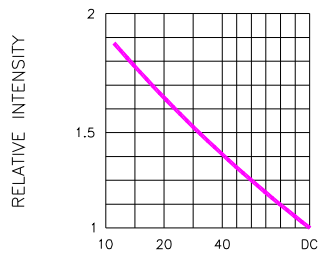

Fig.5 LUMINOUS INTENSITY VS. DUTY CYCLE

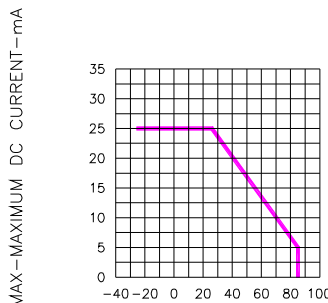

Fig.4 MAXIMUM ALLOWABLE DC CURRENT PER SEGMENT VS. A FUNCTION OF AMBIENT TEMPERATURE

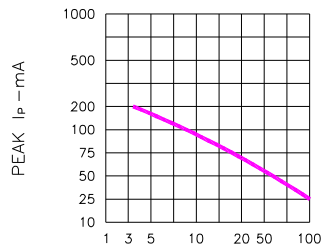
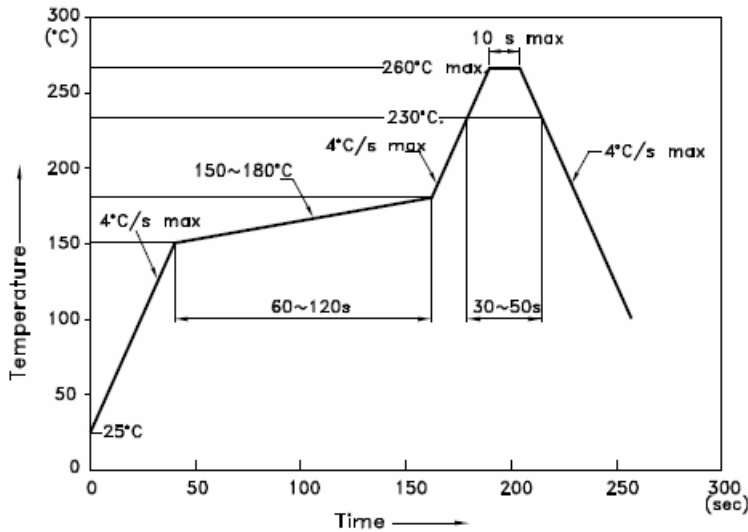

Fig.6 MAX PEAK CURRENT VS. DUTY CYCLE % (REFRESH RATE  $f = 1\text{ KHz}$ )

Model No : CSD-S40228/S40229M9

## SMT REFLOW SOLDERING INSTRUCTIONS

### IR Reflow Temperature / Time :



**NOTES:**

1. We recommend the reflow temperature 245°C(+/-5°C). The maximum soldering temperature should be limited to 260°C.
2. Don't cause stress to the epoxy resin while it is exposed to high temperature.
3. Number of reflow process shall be 2 times or less.

### Soldering Pad Size

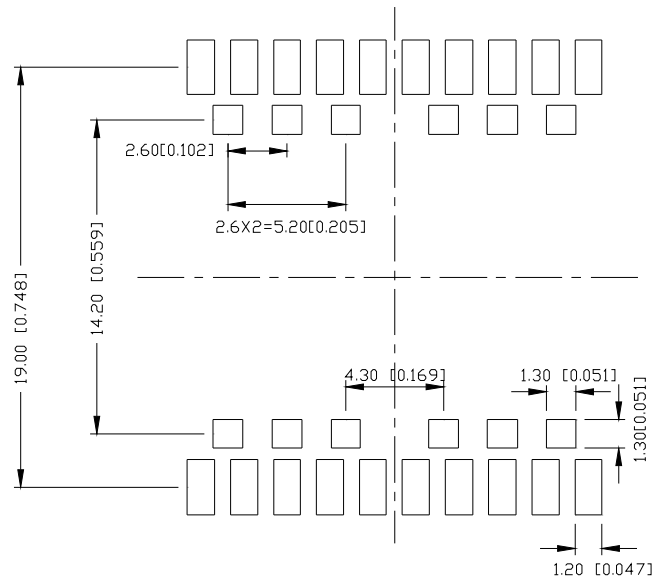



Spec. No.	PS-DD-S40228/S40229M9
Rev.	A

Model No : CSD-S40228/S40229M9

REEL DIMENSIONS

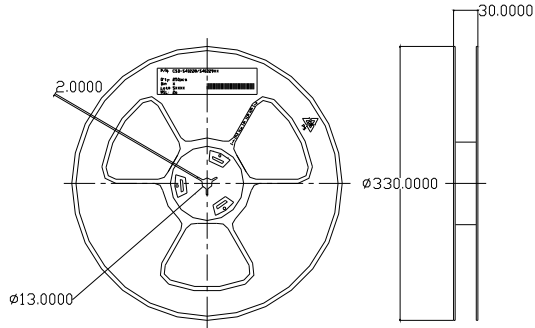

PACKING & LABEL SPECIFICATIONS

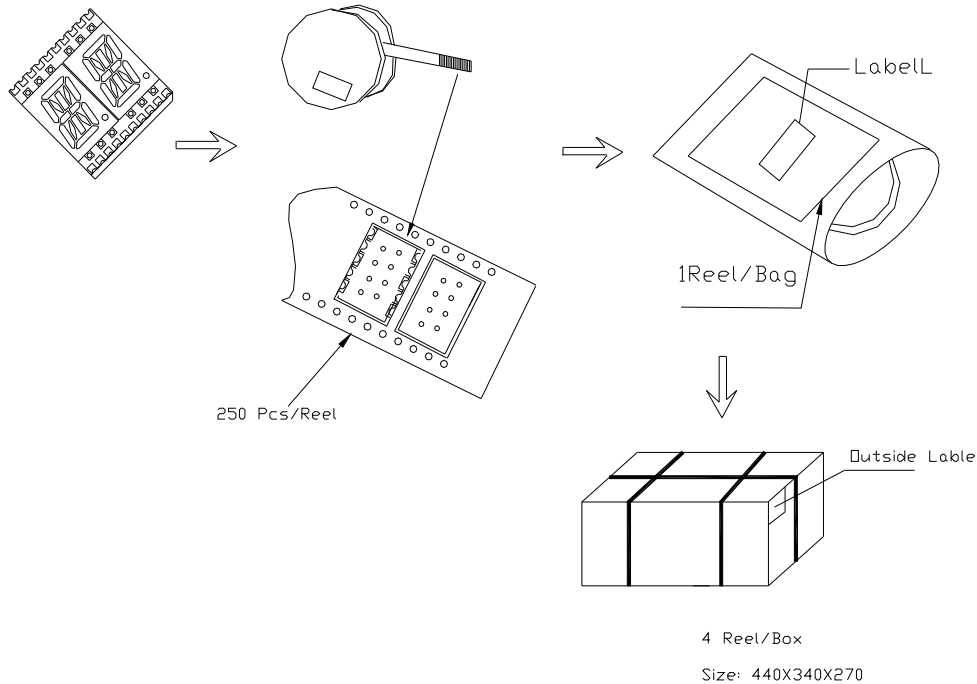

Note: The specifications are subject to change without notice. Please contact us for updated information.