

# CSD02060–silicon Carbide Schottky Diode

## ZERO RECOVERY® RECTIFIER

$$V_{RRM} = 600V$$

$$I_{F(AVG)} = 2A$$

$$Q_c = 7nC$$

### Features

- 600-Volt Schottky Rectifier
- Zero Reverse Recovery
- Zero Forward Recovery
- High-Frequency Operation
- Temperature-Independent Switching Behavior
- Extremely Fast Switching
- Positive Temperature Coefficient on  $V_F$

### Benefits

- Replace Bipolar with Unipolar Rectifiers
- Essentially No Switching Losses
- Higher Efficiency
- Reduction of Heat Sink Requirements
- Parallel Devices Without Thermal Runaway

### Applications

- Switch Mode Power Supplies
- Power Factor Correction
  - Typical PFC  $P_{out}$  : 200W-400W
- Motor Drives
  - Typical Power : 0.50HP-1.0HP

### Package



TO-263-2

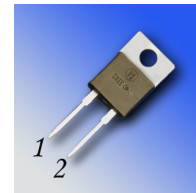

TO-220-2



Part Number	Package	Marking
CSD02060A	TO-220-2	CSD02060
CSD02060G	TO-263-2	CSD02060

### Maximum Ratings

Symbol	Parameter	Value	Unit	Test Conditions	Note
$V_{RRM}$	Repetitive Peak Reverse Voltage	600	V		
$V_{RSM}$	Surge Peak Reverse Voltage	600	V		
$V_{DC}$	DC Blocking Voltage	600	V		
$I_{F(AVG)}$	Average Forward Current	2 3.5	A	$T_c=150^{\circ}C$ , DC $T_c=125^{\circ}C$ , DC	
$I_{F(PEAK)}$	Peak Forward Current	5	A	$T_c=125^{\circ}$ , $T_{REP}<1mS$ , Duty=0.5	
$I_{FRM}$	Repetitive Peak Forward Surge Current	10	A	$T_c=25^{\circ}C$ , $t_p=8.3ms$ , Half Sine Wave	
$I_{FSM}$	Non-Repetitive Peak Forward Surge Current	40	A	$T_c=25^{\circ}C$ , $t_p=10\mu s$ , Pulse	
$P_{tot}$	Power Dissipation	43 14	W	$T_c=25^{\circ}C$ $T_c=125^{\circ}C$	
$T_j, T_{stg}$	Operating Junction and Storage Temperature	-55 to +175	$^{\circ}C$		

## Electrical Characteristics

Symbol	Parameter	Typ.	Max.	Unit	Test Conditions	Note
$V_F$	Forward Voltage	1.6 2.0	1.8 2.4	V	$I_F = 2A$ $T_J = 25^\circ C$ $I_F = 2A$ $T_J = 175^\circ C$	
$I_R$	Reverse Current	50 100	200 1000	$\mu A$	$V_R = 600V$ $T_J = 25^\circ C$ $V_R = 600V$ $T_J = 175^\circ C$	
$Q_C$	Total Capacitive Charge	7		nC	$V_R = 600V$ , $I_F = 1A$ $di/dt = 500 A/\mu s$ $T_J = 25^\circ C$	
C	Total Capacitance	120 20 15		pF	$V_R = 0V$ , $T_J = 25^\circ C$ , $f = 1MHz$ $V_R = 200V$ , $T_J = 25^\circ C$ , $f = 1MHz$ $V_R = 400V$ , $T_J = 25^\circ C$ , $f = 1MHz$	

Note:

1. This is a majority carrier diode, so there is no reverse recovery charge.

## Thermal Characteristics

Symbol	Parameter	Typ.	Max.	Unit	Test Conditions	Note
$R_{\theta JC}$	Thermal Resistance from Junction to Case	4.7		$^\circ C/W$		
$R_{\theta JA}$	Thermal Resistance from Junction to Ambient	53		$^\circ C/W$		

## Typical Performance

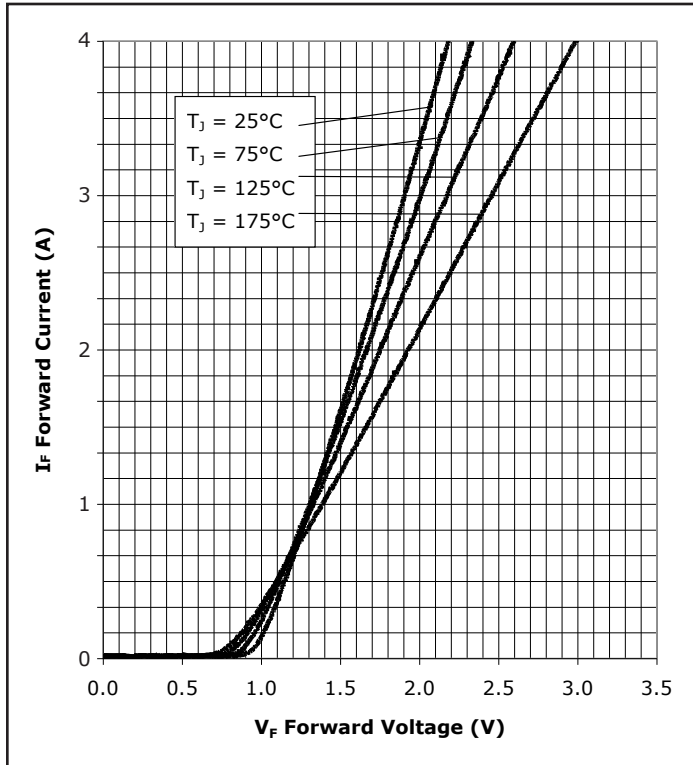

Figure 1. Forward Characteristics

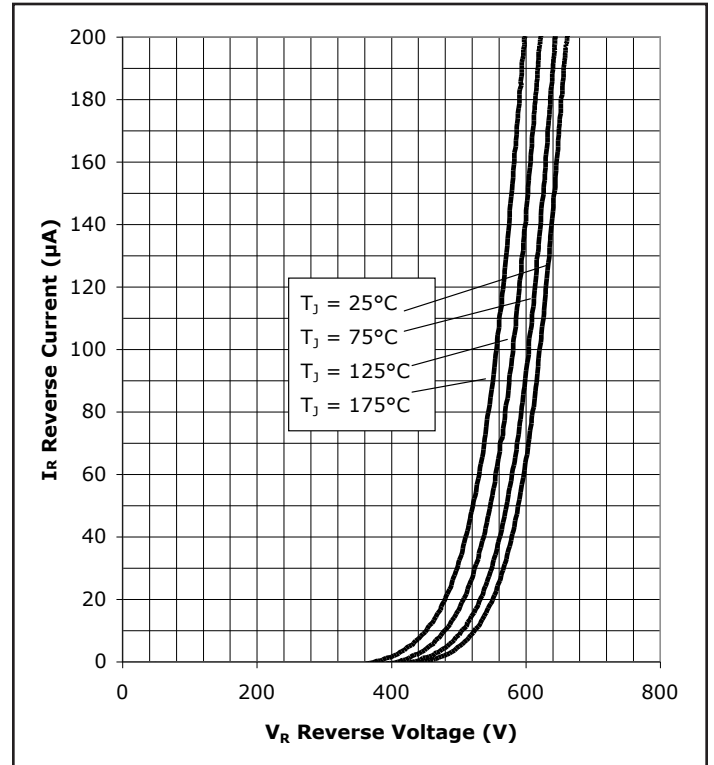

Figure 2. Reverse Characteristics

### Typical Performance

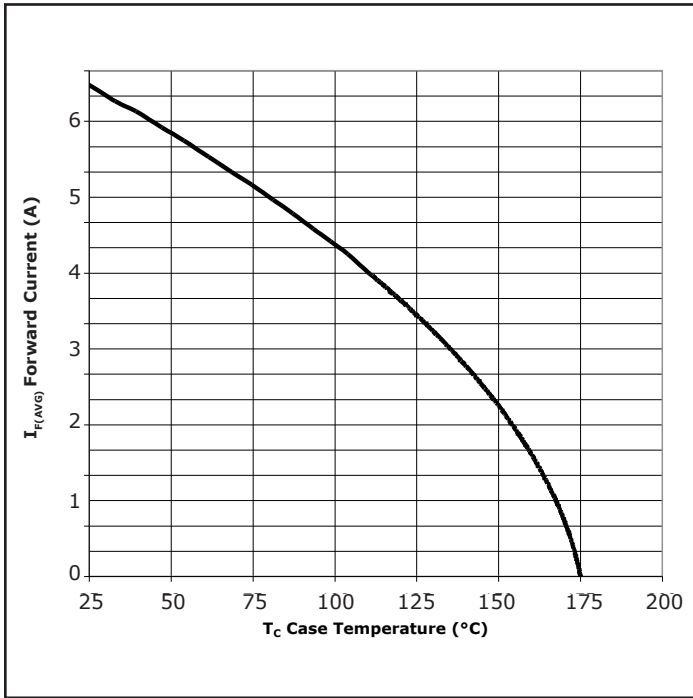

Figure 3. Current Derating

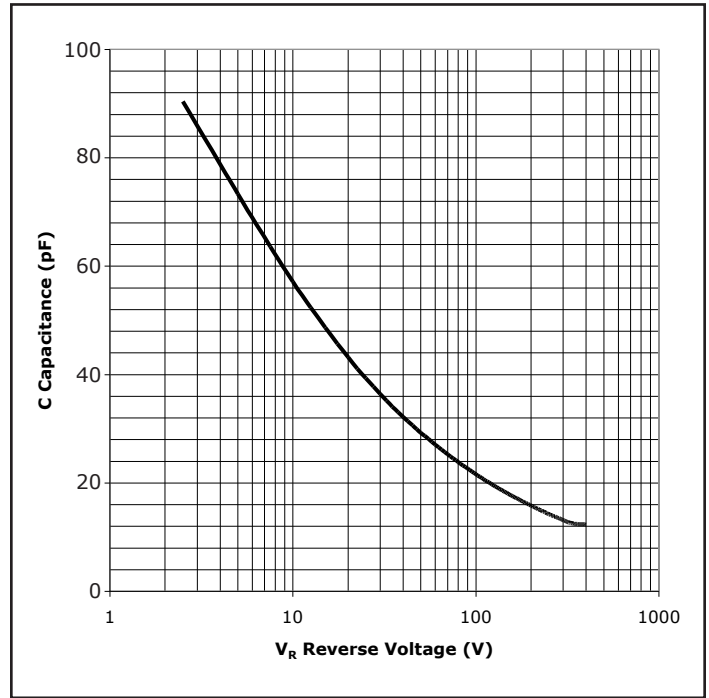

Figure 4. Capacitance vs. Reverse Voltage

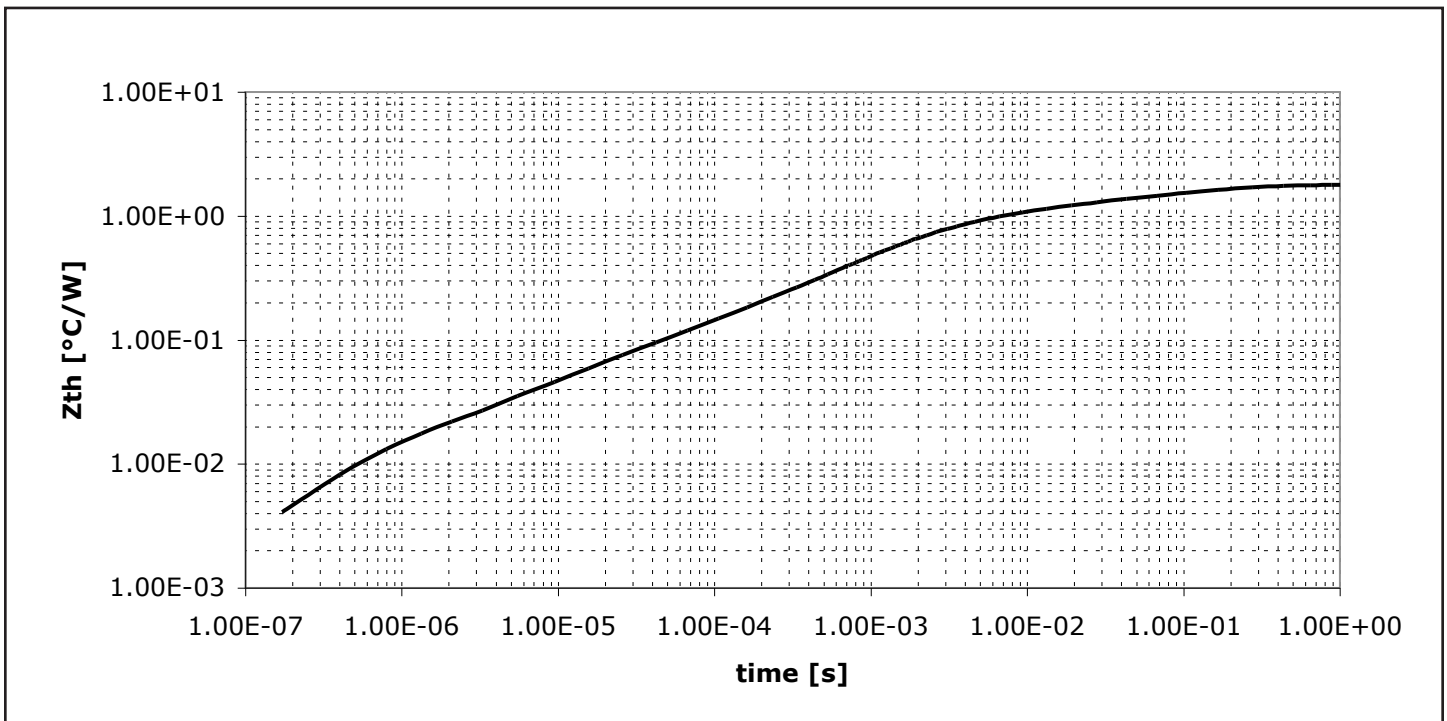
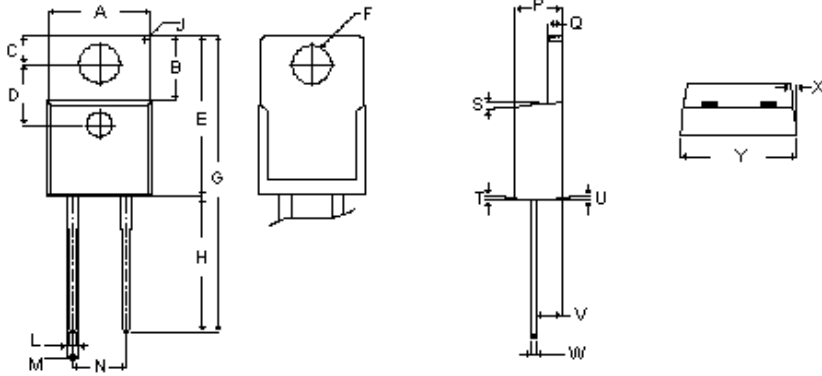

Figure 5. Transient Thermal Impedance

## Package Dimensions

### Package TO-220-2



POS	Inches		Millimeters	
	Min	Max	Min	Max
A	.402	.408	10.211	10.364
B	.120	.124	3.048	3.150
C	.106	.110	2.692	2.794
D	.245	.251	6.223	6.375
E	.335	.345	8.509	8.763
F	.149	.153	3.784	3.886
G	.220	.240	5.588	6.096
H	.540	.550	13.716	13.970
J	.100 REF		2.540 REF	
K		.080		2.032
L	.050	.056	1.270	1.422
M	.032	.038	.813	.956
N	.197	.203	5.004	5.156
P	.170	.180	4.318	4.572
Q	.048	.052	1.219	1.321
R	.583	.593	14.808	15.062
S	6.5°	8.5°	6.5°	8.5°
T	6.5°	8.5°	6.5°	8.5°
U	6.5°	8.5°	6.5°	8.5°
V	.103	.107	2.616	2.718
W	.015	.021	.381	.533
X	2.0°	4.0°	2.0°	4.0°
Y	.396	.406	10.058	10.312

NOTE:

1. Dimension L, M, W apply for Solder Dip Finish.

## Package Dimensions

### Package TO-263-2

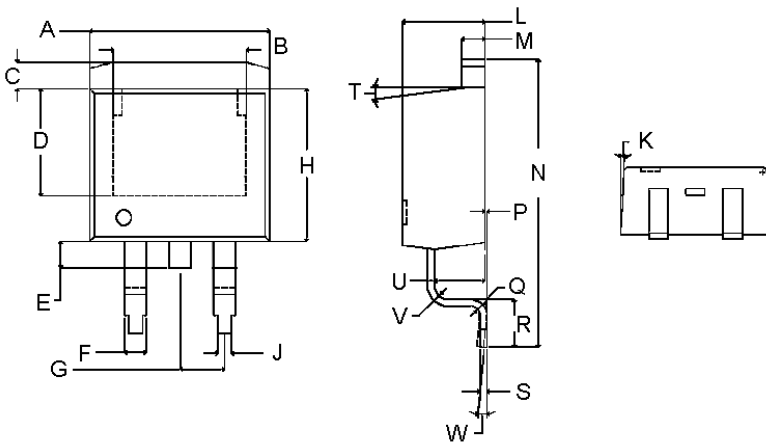

POS	Inches		Millimeters	
	Min	Max	Min	Max
A	.396	.406	10.058	10.312
B	.297	.303	7.544	7.696
C	.057	.063	1.448	1.600
D	.237	.243	6.015	6.167
E	.050	.070	1.270	1.778
F	.048	.052	1.219	1.321
G	.100 TYP		2.540 TYP	
H	.335	.345	8.509	8.763
J	.028	.032	.711	.813
K	2°	4°	2°	4°
L	.170	.180	4.318	4.572
M	.048	.052	1.219	1.321
N	.595	.615	15.113	15.621
P	0.00	0.10	0.00	.254
Q	R0.018 TYP	R0.022 TYP	R0.457 TYP	R0.559 TYP
R	.090	.110	2.286	2.794
S	.013	.017	.330	.432
T	6.5°	8.5°	6.5°	8.5°
U	.103	.107	2.616	2.718
V	R0.028 TYP	R0.032 TYP	R0.711 TYP	R0.813 TYP
W	—	5.0°	—	5.0°

## Recommended Solder Pad Layout

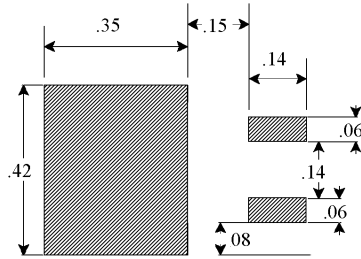

TO-263-2

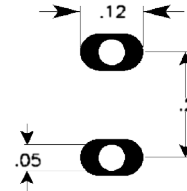

TO-220-2

Part Number	Package	Marking
CSD02060A	TO-220-2	CSD02060
CSD02060G	TO-263-2	CSD02060

This product has not been designed or tested for use in, and is not intended for use in, applications implanted into the human body nor in applications in which failure of the product could lead to death, personal injury or property damage, including but not limited to equipment used in the operation of nuclear facilities, life-support machines, cardiac defibrillators or similar emergency medical equipment, aircraft navigation or communication or control systems, air traffic control systems, or weapons systems.

Copyright © 2006 Cree, Inc. All rights reserved. The information in this document is subject to change without notice. Cree, the Cree logo, and Zero Recovery are registered trademarks of Cree, Inc.

Cree, Inc.  
4600 Silicon Drive  
Durham, NC 27703  
USA Tel: +1.919.313.5300  
Fax: +1.919.313.5451  
[www.cree.com/power](http://www.cree.com/power)