

N-Channel CICLON NexFET™ Power MOSFETs CSD16413Q5A



Features

- Ultra Low Qg & Qgd
- Low Thermal Resistance
- Avalanche Rated
- Pb Free Terminal Plating
- RoHS Compliant
- Halogen Free



QFN 5mm x 6mm Plastic Package

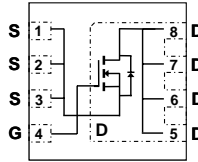

Top View

Product Summary

V_{DS}	25	V
Q_g	9.0	nC
Q_{gd}	2.5	nC
$R_{DS(on)}$	$V_{GS}=4.5V$	4.1 m Ω
	$V_{GS}=10V$	3.1 m Ω
V_{th}	1.6	V

Maximum Values ($T_A = 25^\circ C$ unless otherwise stated)

Symbol	Parameter	Value	Units
V_{DS}	Drain to Source Voltage	25	V
V_{GS}	Gate to Source Voltage	+16 / -12	V
I_D	Continuous Drain Current, $T_C = 25^\circ C$	100	A
	Continuous Drain Current ¹	24	A
I_{DM}	Pulsed Drain Current, $T_A = 25^\circ C^2$	156	A
P_D	Power Dissipation ¹	3.1	W
T_J, T_{STG}	Operating Junction and Storage Temperature Range	-55 to 150	$^\circ C$
E_{AS}	Avalanche Energy, single pulse $I_D=46A, L = 0.1mH, R_G = 25\Omega$	106	mJ

1. $R_{\theta ja} = 41^\circ C/W$ on $1in^2$ Cu FR4 PCB.
2. Pulse width $\leq 300 \mu s$, duty cycle $\leq 2\%$

$R_{DS(on)}$ vs. V_{GS}

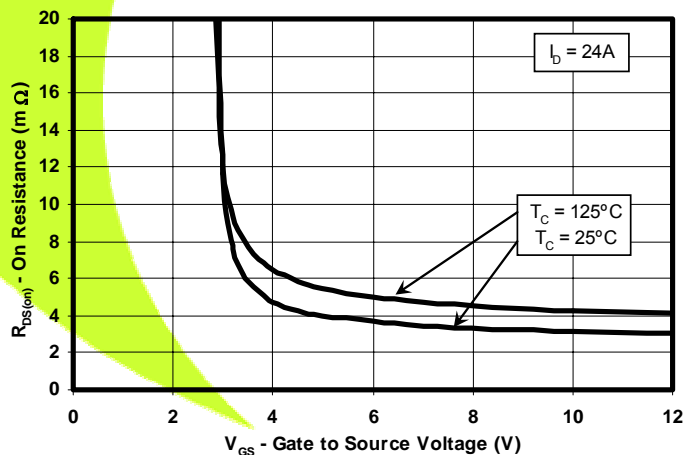

Gate Charge

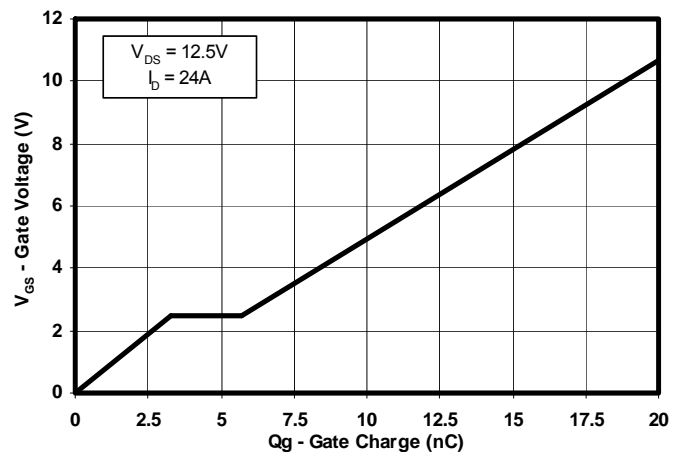

Ordering Information

Type	Package	Package Media	Qty	Ship
CSD16413Q5A	QFN 5X6 Plastic Package	13 inch reel	2500	Tape and Reel

N-Channel
CICLON NexFET™ Power MOSFETs
CSD16413Q5A



Electrical Characteristics ($T_A = 25^\circ\text{C}$ unless otherwise stated)

Symbol	Parameter	Test Conditions	Min	Typ	Max	Units
Static Characteristics						
BV_{DSS}	Drain to Source Voltage	$V_{GS} = 0V, I_D = 250\mu A$	25	—	—	V
I_{DSS}	Drain to Source Leakage Current	$V_{GS} = 0V, V_{DS} = 20V$	—	—	1	μA
I_{GSS}	Gate to Source Leakage Current	$V_{DS} = 0V, V_{GS} = +16/-12V$	—	—	100	nA
$V_{GS(th)}$	Gate to Source Threshold Voltage	$V_{DS} = V_{GS}, I_D = 250\mu A$	1.2	1.6	1.9	V
$R_{DS(on)}$	Drain to Source On Resistance	$V_{GS} = 4.5V, I_D = 24A$	—	4.1	5.6	$m\Omega$
		$V_{GS} = 10V, I_D = 24A$	—	3.1	3.9	$m\Omega$
g_{fs}	Transconductance	$V_{DS} = 15V, I_D = 24A$	—	95	—	S
Dynamic Characteristics						
C_{ISS}	Input Capacitance	$V_{GS} = 0V, V_{DS} = 12.5V$ $f = 1MHz$	—	1370	1780	pF
C_{OSS}	Output Capacitance		—	1060	1380	pF
C_{RSS}	Reverse Transfer Capacitance		—	84	109	pF
R_g	Series Gate Resistance		—	0.9	—	Ω
Q_g	Gate Charge Total (4.5V)	$V_{DS} = 12.5V, I_D = 24A$	—	9.0	11.7	nC
Q_{gd}	Gate Charge Gate to Drain		—	2.5	—	nC
Q_{gs}	Gate Charge Gate to Source		—	3.5	—	nC
$Q_{g(th)}$	Gate Charge at V_{th}		—	2.2	—	nC
Q_{OSS}	Output Charge	$V_{DS} = 13.1V, V_{GS} = 0V$	—	21	—	nC
$t_{d(on)}$	Turn On Delay Time	$V_{DS} = 12.5V$ $V_{GS} = 4.5V, I_D = 24A$ $R_G = 5.0\Omega$	—	12.9	—	ns
t_r	Rise Time		—	27	—	ns
$t_{d(off)}$	Turn Off Delay Time		—	15.7	—	ns
t_f	Fall Time		—	16.4	—	ns
Diode Characteristics						
V_{SD}	Diode Forward Voltage	$I_S = 24A, V_{GS} = 0V$	—	0.85	1.0	V
Q_{rr}	Reverse Recovery Charge	$V_{dd} = 13.1V, I_F = 24A,$ $di/dt = 300A/\mu s$	—	32	—	nC
t_{rr}	Reverse Recovery Time	$V_{dd} = 13.1V, I_F = 24A,$ $di/dt = 300A/\mu s$	—	28	—	ns

N-Channel CICLON NexFET™ Power MOSFETs CSD16413Q5A



Thermal Characteristics ($T_A = 25^\circ\text{C}$ unless otherwise stated)

Symbol	Parameter	Min	Typ	Max	Units
Thermal Characteristics					
$R_{\theta JC}$	Thermal Resistance Junction to Case ³	—	—	2.6	$^\circ\text{C/W}$
$R_{\theta JA}$	Thermal Resistance Junction to Ambient (1 in ² Cu area) ^{3,4}	—	—	51	$^\circ\text{C/W}$

- $R_{\theta JC}$ is determined with the device mounted on a 1in square 2 oz. Cu pad on a 1.5x1.5 in .060in thick FR4 board. $R_{\theta JC}$ is guaranteed by design while $R_{\theta ca}$ is determined by the user's board design.
- Device mounted on FR4 Material with 1in² of 2 oz. Cu.

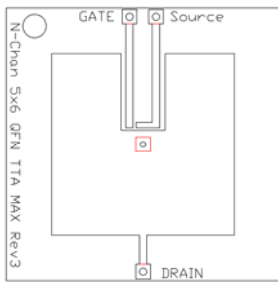

Max $R_{\theta JA} = 51^\circ\text{C/W}$ when mounted on 1in² of 2 oz. Cu.

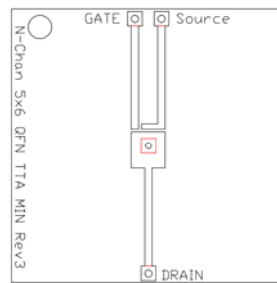

Max $R_{\theta JA} = 118^\circ\text{C/W}$ when mounted on min pad area of 2 oz. Cu.

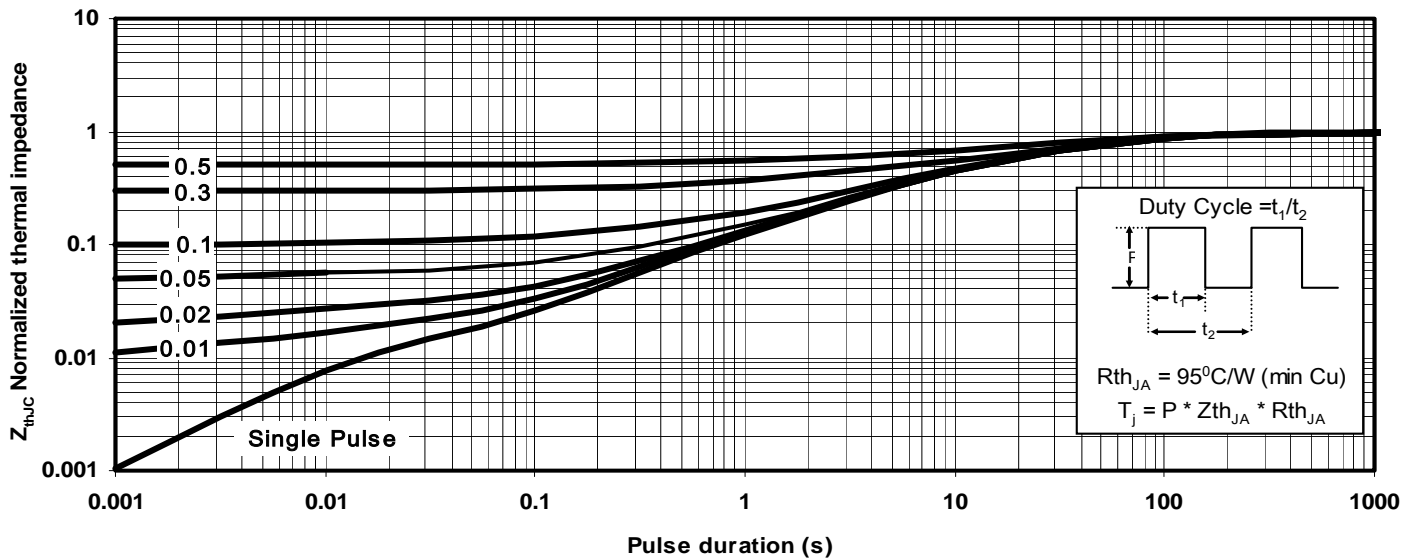

Figure 1: Transient Thermal Impedance

N-Channel
CICLON NexFET™ Power MOSFETs
CSD16413Q5A



Typical MOSFET Characteristics ($T_A = 25^\circ\text{C}$ unless otherwise stated)

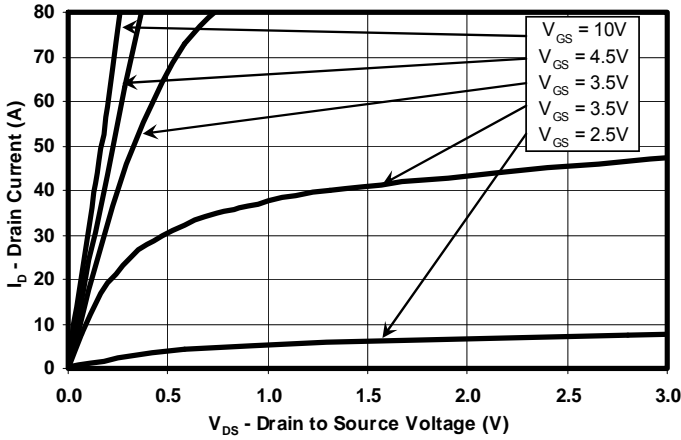

Figure 2: Saturation Characteristics

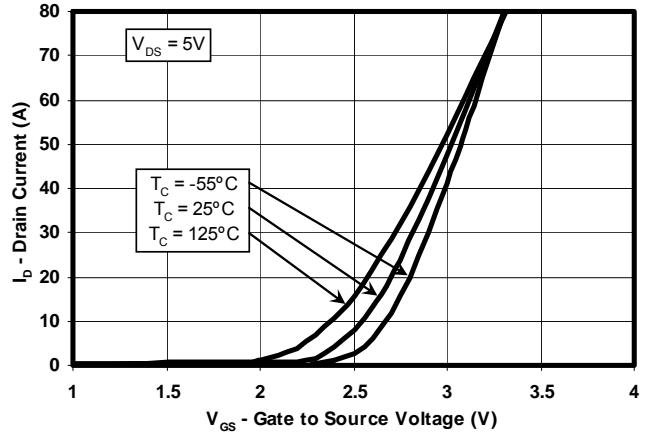

Figure 3: Transfer Characteristics

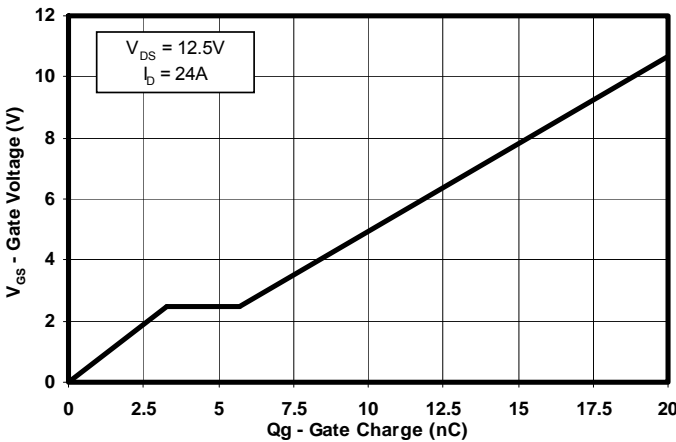

Figure 4: Gate Charge

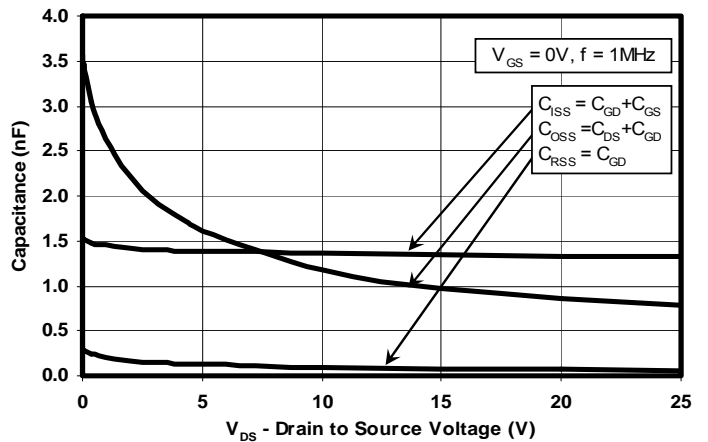

Figure 5: Capacitance

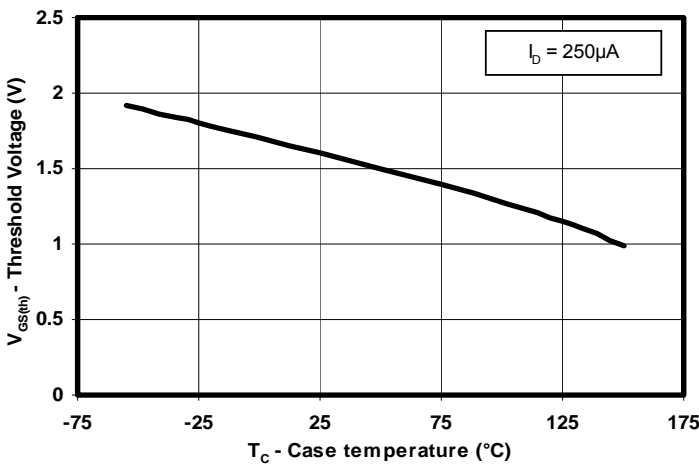

Figure 6: Threshold Voltage vs. Temperature

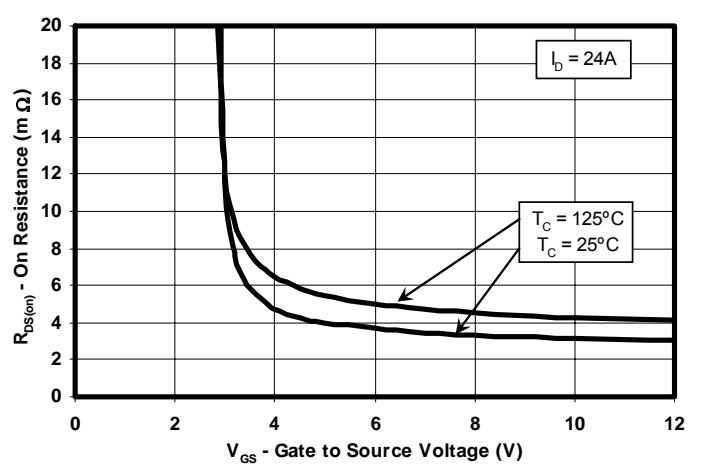

Figure 7: On Resistance vs. Gate Voltage

N-Channel CICLON NexFET™ Power MOSFETs CSD16413Q5A



Typical MOSFET Characteristics ($T_A = 25^\circ\text{C}$ unless otherwise stated)

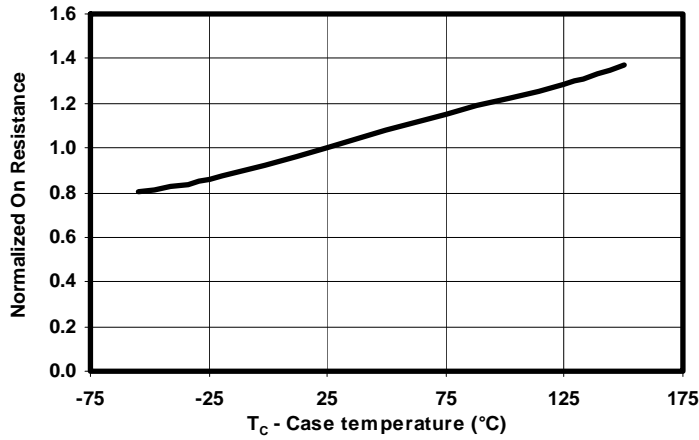

Figure 8: On Resistance vs. Temperature

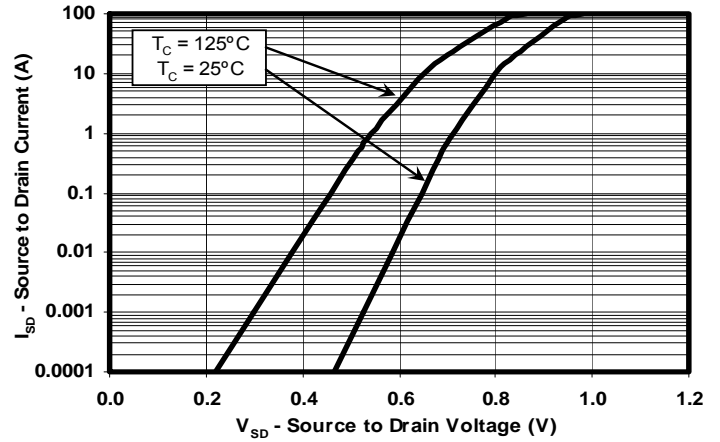

Figure 9: Typical Diode Forward Voltage

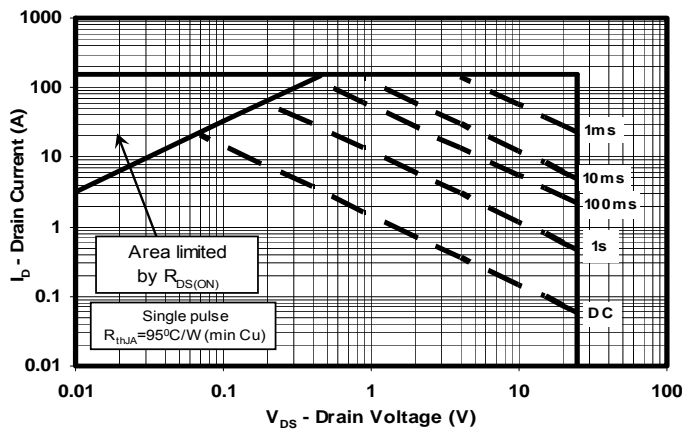

Figure 10: Maximum Safe Operating Area

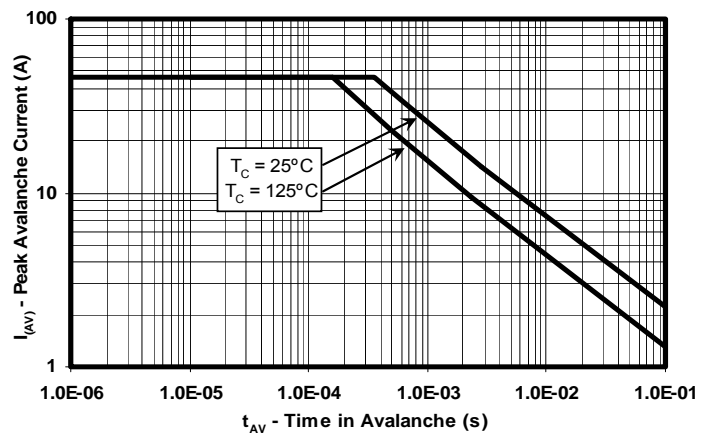

Figure 11: Single Pulse Unclamped Inductive Switching

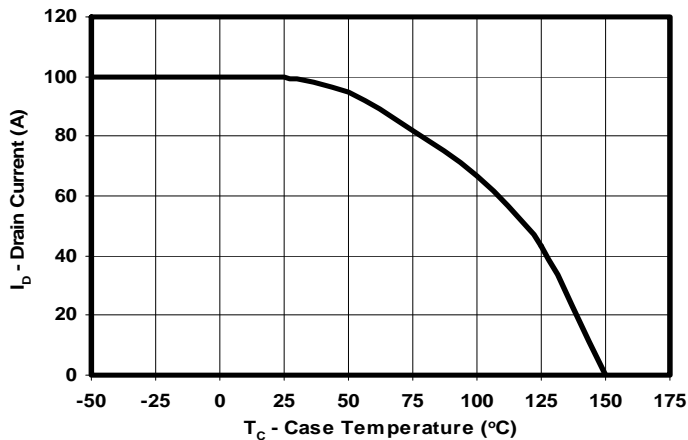
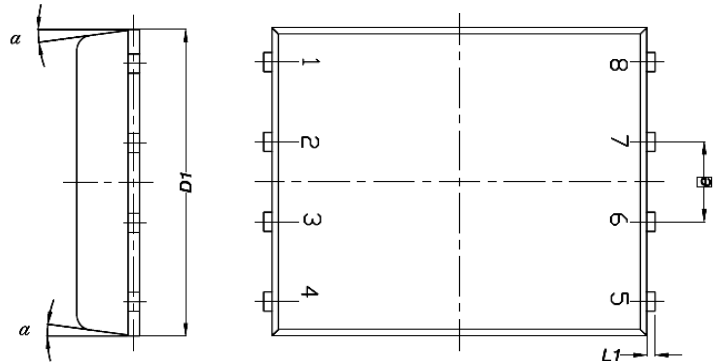
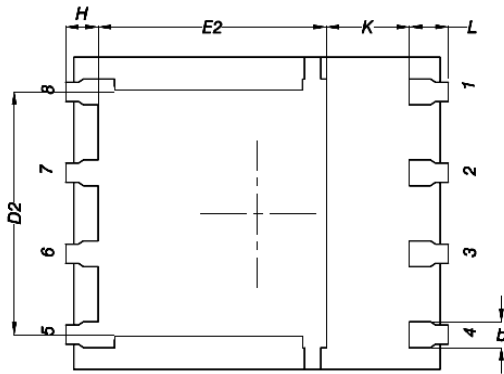

Figure 12: Maximum Drain Current vs. Temperature

N-Channel
CICLON NexFET™ Power MOSFETs
CSD16413Q5A



CSD16413Q5A Package Dimensions



RECOMMENDED PCB PATTERN

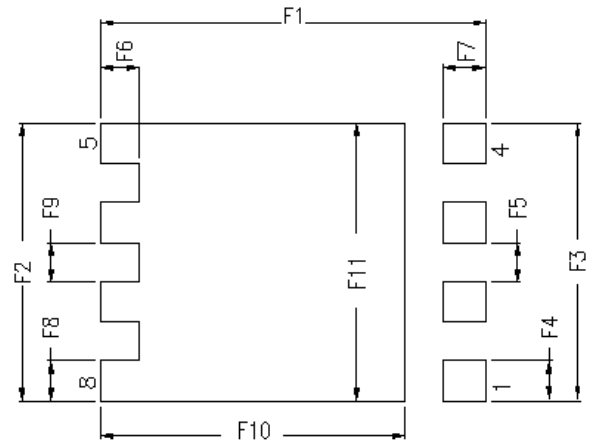

DIM	MILLIMETERS		
	MIN	NOM	MAX
A	0.90	1.00	1.10
b	0.33	0.41	0.51
c	0.20	0.25	0.30
D1	4.80	4.90	5.00
D2	3.61	3.81	3.96
E	5.90	6.00	6.10
E1	5.70	5.75	5.80
E2	3.38	3.58	3.78
e	1.27 BSC		
H	0.41	0.51	0.61
K	1.10		
L	0.51	0.61	0.71
L1	0.06	0.13	0.20
a	0°		12°

DIM	MILLIMETERS		INCHES	
	Min	Max	Min	Max
F1	6.205	6.305	0.244	0.248
F2	4.46	4.56	0.176	0.18
F3	4.46	4.56	0.176	0.18
F4	0.65	0.7	0.026	0.028
F5	0.62	0.67	0.024	0.026
F6	0.63	0.68	0.025	0.027
F7	0.7	0.8	0.028	0.031
F8	0.65	0.7	0.026	0.028
F9	0.62	0.67	0.024	0.026
F10	4.9	5	0.193	0.197
F11	4.46	4.56	0.176	0.18

N-Channel CICLON NexFET™ Power MOSFETs CSD16413Q5A



Q5A Tape and Reel Information

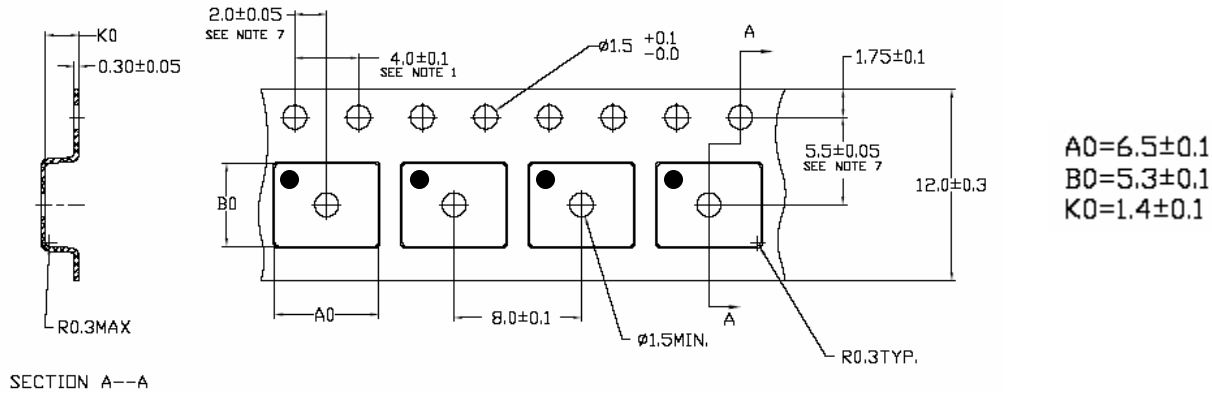

Note:

1. 10 SPROCKET HOLE PITCH CUMULATIVE TOLERANCE +/-0.2
2. CAMBER NOT TO EXCEED 1mm IN 100mm, NONCUMULATIVE OVER 250mm
3. MATERIAL:BLACK STATIC DISSIPATIVE POLYSTYRENE
4. ALL DIMENSIONS ARE IN mm (UNLESS OTHERWISE SPECIFIED)
5. A0 AND B0 MEASURED ON A PLANE 0.3mm ABOVE THE BOTTOM OF THE POCKET

Package Marking Information

Location:

1st Line

CSD = Fixed Characters

NNNN = Product Code

2nd Line (Date Code)

YY = Last 2 digits of the Year

WW = 2-digit Work Week

C = Country of Origin

> Philippines = P

> Taiwan = T

> China = C

3rd Line

LLLLL = Last 5 digits of the Wafer Lot #

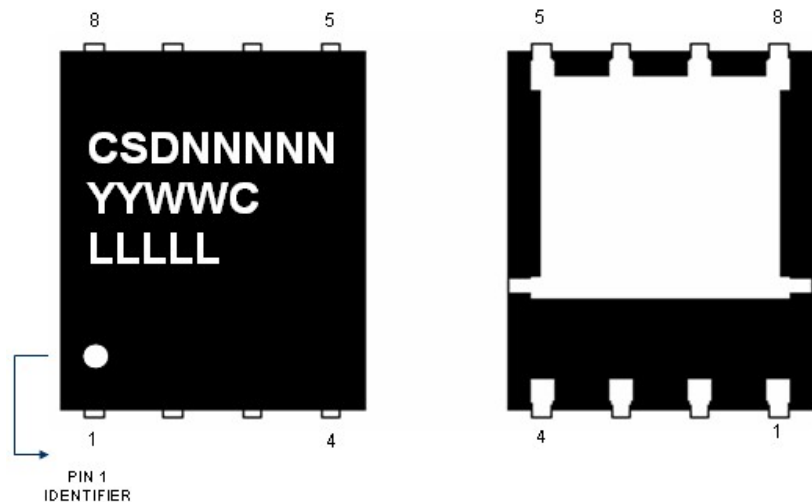

N-Channel
CICLON NexFET™ Power MOSFETs
CSD16413Q5A



Disclaimer

CICLON Semiconductor Device Corp. ("**CICLON**") reserves the right to make corrections, modifications, enhancements, improvements and other changes to its products and services at any time and to discontinue any product or service without notice. Customers should obtain the latest relevant information before placing orders and should verify that such information is current and complete. All products are sold subject to **CICLON**'s terms and conditions of sale supplied at the time of order acknowledgement.

Additional Information

For further information on technology, delivery terms and conditions, or pricing please contact your nearest **CICLON** Semiconductor representative.

CICLON Semiconductor Device Corp.
116 Research Drive, Bethlehem, PA 18015
T 610-849-5100 **F** 610-849-5101