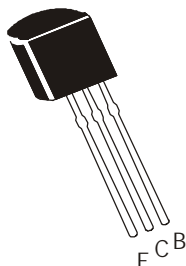

**NPN SILICON PLANAR EPITAXIAL, HIGH SPEED,
HIGH VOLTAGE SWITCHING TRANSISTOR**

CSL13003

**TO-92
Plastic Package**
**Applications**

Suitable for Lighting, Switching Regulator and Motor Control

ABSOLUTE MAXIMUM RATINGS

DESCRIPTION	SYMBOL	VALUE	UNIT
Collector Base Voltage	V_{CBO}	600	V
Collector Emitter (sus) Voltage	V_{CEO}	400	V
Emitter Base Voltage	V_{EBO}	9.0	V
Collector Current Continuous	I_C	1.5	A
Peak	** I_{CM}	3.0	A
Power Dissipation @ $T_a=25^\circ\text{C}$	P_C	1.1	W
Derate Above 25°C		8.8	mW/ $^\circ\text{C}$
Power Dissipation @ $T_{Lead}=25^\circ\text{C}$	P_D	2.0	W
Derate Above 25°C		16	mW/ $^\circ\text{C}$
Operating And Storage Junction Temperature Range	T_j, T_{stg}	- 65 to +150	$^\circ\text{C}$

THERMAL RESISTANCE

Junction to Case, $T_c=25^\circ\text{C}$	$R_{th(j-c)}$	48.0	$^\circ\text{C/W}$
Junction to Lead	$R_{th(j-L)}$	62.5	$^\circ\text{C/W}$
Junction to Ambient in free air	$R_{th(j-a)}$	113.6	$^\circ\text{C/W}$

ELECTRICAL CHARACTERISTICS ($T_a=25^\circ\text{C}$ unless specified otherwise)

DESCRIPTION	SYMBOL	TEST CONDITION	MIN	TYP	MAX	UNIT
Collector Base Voltage	V_{CBO}	$I_C=1\text{mA}, I_E=0$	600			V
Collector Emitter (sus) Voltage	* $V_{CEO(sus)}$	$I_C=10\text{mA}, I_B=0$	400			V
Collector Cut Off Current	I_{CBO}	$V_{CB}=600\text{V}, I_E=0$ $V_{CB}=600\text{V}, I_E=0, T_c=100^\circ\text{C}$			1.0 5.0	mA mA
Emitter Cut Off Current	I_{EBO}	$V_{EB}=9\text{V}, I_C=0$			1.0	mA
DC Current Gain	* h_{FE}	$I_C=0.3\text{A}, V_{CE}=2\text{V}$ (Note1) $I_C=0.5\text{A}, V_{CE}=2\text{V}$ $I_C=1\text{A}, V_{CE}=2\text{V}$	10 8.0 4.0		30 40 25	
Collector Emitter Saturation Voltage	* $V_{CE(sat)}$	$I_C=0.5\text{A}, I_B=0.1\text{A}$ $I_C=1\text{A}, I_B=0.25\text{A}$ $I_C=1.5\text{A}, I_B=0.5\text{A}$ $I_C=1\text{A}, I_B=0.25\text{A}, T_c=100^\circ\text{C}$			0.5 1.0 3.0 1.0	V V V V
Base Emitter Saturation Voltage	* $V_{BE(sat)}$	$I_C=0.5\text{A}, I_B=0.1\text{A}$ $I_C=1\text{A}, I_B=0.25\text{A}$ $I_C=1\text{A}, I_B=0.25\text{A}, T_c=100^\circ\text{C}$			1.0 1.2 1.1	V V V

* Pulse Test: PW=300ms, Duty Cycle=2%

** Pulse Test: Pulse Width=5ms, Duty Cycle=10%

CSL13003Rev261103E

**NPN SILICON PLANAR EPITAXIAL, HIGH SPEED,
HIGH VOLTAGE SWITCHING TRANSISTOR**

CSL13003

**TO-92
Plastic Package**

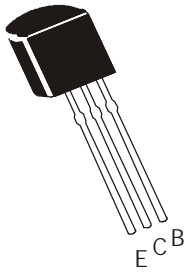

DYNAMIC CHARACTERISTICS

DESCRIPTION	SYMBOL	TEST CONDITION	MIN	TYP	MAX	UNIT
Current Gain Bandwidth Product	f_T	$I_C=100\text{mA}$, $V_{CE}=10\text{V}$, $f=1\text{MHz}$	4.0			MHz
Output Capacitance	C_{ob}	$V_{CB}=10\text{V}$, $f=0.1\text{MHz}$		21		pF

SWITCHING TIME

DESCRIPTION	SYMBOL	TEST CONDITION	MIN	TYP	MAX	UNIT
Turn On Time	t_{on}	$V_{CC}=125\text{V}$			1.1	μs
Fall Time	t_f	$I_{B1}=0.2\text{A}$, $I_{B2}=0.2\text{A}$			0.7	μs
Storage Time	t_{stg}	$I_C=1\text{A}$			4.0	μs

Note (1) h_{FE} Classifications:-	A	B	C	E	F
Note (1):- Product is pre selected in DC current gain (Groups A to F). CDIL reserves the right to ship any of the groups according to production availability.	10-16	15-19	18-22	21-25	24-30
MARKING	CSL 13003 A	CSL 13003 B	CSL 13003 C	CSL 13003 E	CSL 13003 F

CSL13003Rev261103E

TO-92 Plastic Package

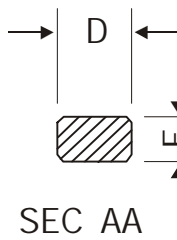
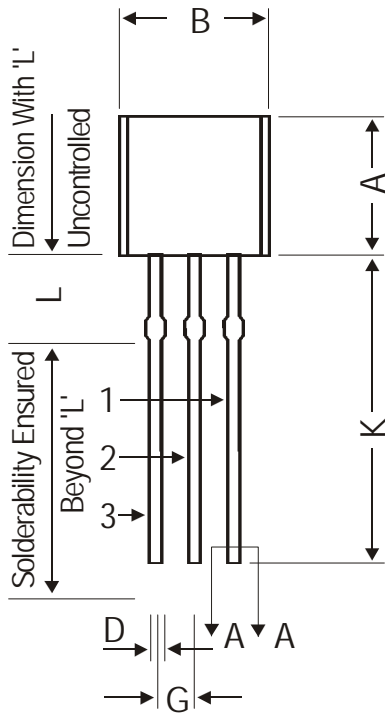

DIM	MIN.	MAX.
A	4.32	5.33
B	4.45	5.20
C	3.18	4.19
D	0.41	0.55
E	0.35	0.50
F	5 DEG	
G	1.14	1.40
H	1.20	1.40
K	12.70	—
L	1.982	2.082
M	1.03	1.20

All dimensions are in mm

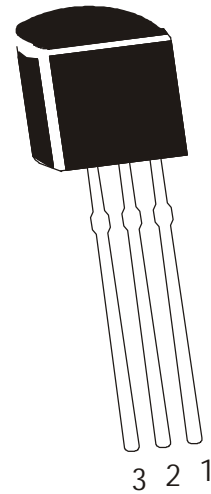
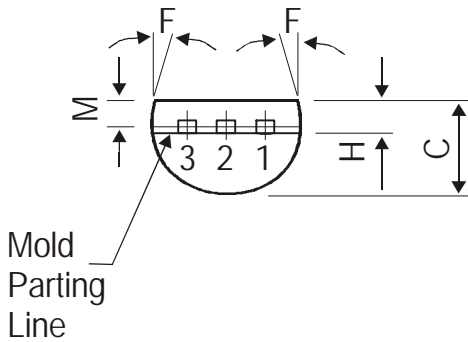

PIN CONFIGURATION

1. BASE
2. COLLECTOR
3. EMITTER

The TO-92 Package, Tape and Ammo Pack Drawings are correct as on the date of issue/revision of this Data Sheet.

The currently valid dimensions and information, may please be confirmed from the TO-92 Drawing in the Packages and Packing Section of the Product Catalogue.

Packing Details

PACKAGE	STANDARD PACK		INNER CARTON BOX		OUTER CARTON BOX		
	Details	Net Weight/Qty	Size	Qty	Size	Qty	Gr Wt
TO-92 Bulk	1K/polybag	200 gm/1K pcs	3" x 7.5" x 7.5"	5K	17" x 15" x 13.5"	80K	23 kgs
TO-92 T&A	2K/ammo box	645 gm/2K pcs	12.5" x 8" x 1.8"	2K	17" x 15" x 13.5"	32K	12.5 kgs

CSL13003Rev261103E

TO-92 Tape and Ammo Pack

Tape Mechanical Data

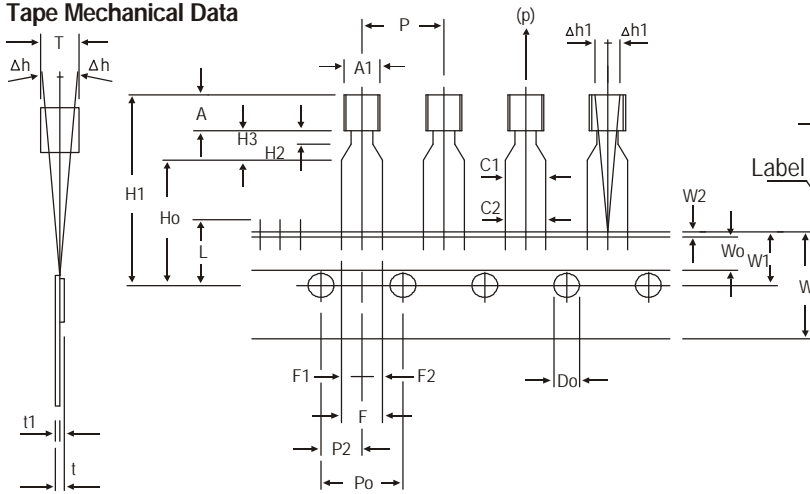

Ammo Pack Style

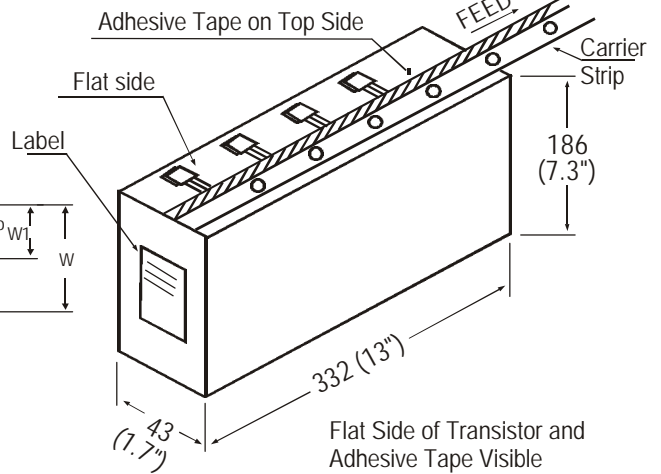

All dimensions are in mm

ITEM	SYMBOL	SPECIFICATION			
		MIN.	NOM.	MAX.	TOL.
BODY WIDTH	A1	4.0		4.8	
BODY HEIGHT	A	4.8		5.2	
BODY THICKNESS	T	3.9		4.2	
PITCH OF COMPONENT	P		12.7		± 1.0
*1 FEED HOLE PITCH	Po		12.7		± 0.3
*2 FEED HOLE CENTRE TO COMPONENT CENTRE	P2		6.35		± 0.4
DISTANCE BETWEEN OUTER LEADS	F		5.08		+ 0.6 - 0.2
*3 COMPONENT ALIGNMENT SIDE VIEW	Δh		0	1.0	
*4 COMPONENT ALIGNMENT FRONT VIEW	Δh1		0	1.3	
TAPE WIDTH	W		18		± 0.5
HOLD-DOWN TAPE WIDTH	Wo		6		± 0.2
HOLE POSITION	W1		9		+ 0.7 - 0.5
HOLD-DOWN TAPE POSITION	W2		0.5		± 0.2
LEAD WIRE CLINCH HEIGHT	Ho		16		± 0.5
COMPONENT HEIGHT	H1			23.25	
LENGTH OF SNIPPED LEADS	L			11.0	
FEED HOLE DIAMETER	Do		4		± 0.2
*5 TOTAL TAPE THICKNESS	t			1.2	
LEAD - TO - LEAD DISTANCE	F1, F2		2.54		+ 0.4 - 0.1
STAND OFF	H2	0.45		1.45	
CLINCH HEIGHT	H3			3.0	
LEAD PARALLELISM	C1 - C2			0.22	
PULL - OUT FORCE	(p)	6N			

NOTES

1. Maximum alignment deviation between leads will not to be greater than 0.2mm.
2. Maximum non-cumulative variation between tape feed holes shall not exceed 1 mm in 20 pitches.
3. Holddown tape will not exceed beyond the edge(s) of carrier tape and there shall be no exposure of adhesive.
4. There will be no more than three (3) consecutive missing components in a tape.
5. A tape trailer, having at least three feed holes are provided after the last component in a tape.
6. Splices should not interfere with the sprocket feed holes.

REMARKS

- *1 Cumulative pitch error 1.0 mm/20 pitch
- *2 To be measured at bottom of clinch
- *3 At top of body
- *4 At top of body
- *5 t1 0.3 – 0.6 mm

Disclaimer

The product information and the selection guides facilitate selection of the CDIL's Discrete Semiconductor Device(s) best suited for application in your product(s) as per your requirement. It is recommended that you completely review our Data Sheet(s) so as to confirm that the Device(s) meet functionality parameters for your application. The information furnished in the Data Sheet and on the CDIL Web Site/CD are believed to be accurate and reliable. CDIL however, does not assume responsibility for inaccuracies or incomplete information. Furthermore, CDIL does not assume liability whatsoever, arising out of the application or use of any CDIL product; neither does it convey any license under its patent rights nor rights of others. These products are not designed for use in life saving/support appliances or systems. CDIL customers selling these products (either as individual Discrete Semiconductor Devices or incorporated in their end products), in any life saving/support appliances or systems or applications do so at their own risk and CDIL will not be responsible for any damages resulting from such sale(s).

CDIL strives for continuous improvement and reserves the right to change the specifications of its products without prior notice.



CDIL is a registered Trademark of
Continental Device India Limited

C-120 Naraina Industrial Area, New Delhi 110 028, India.
Telephone + 91-11-2579 6150, 5141 1112 Fax + 91-11-2579 5290, 5141 1119
email@cdil.com www.cdilsemi.com