

### Main Product Characteristics

$I_{F(AV)}$	10A
$V_{RRM}$	45V
$T_J$	150°C
$V_{(Typ)}$	0.48V

#### ■ Features

- Low forward voltage drop.
- Excellent high temperature stability.
- Fast switching capability.
- Suffix "G" indicates Halogen-free part, ex.CSP1045SG-A.
- Lead-free parts meet environmental standards of MIL-STD-19500 /228

#### ■ Mechanical data

- Epoxy : UL94-V0 rated flame retardant.
- Case : Molded plastic, TO-277.
- Lead : Solder plated, solderable per MIL-STD-750, Method 2026.
- Polarity: Indicated by cathode band.
- Mounting Position : Any.
- Weight : Approximated 0.093 grams.

#### ■ Maximum ratings and electrical characteristics

Rating at 25°C ambient temperature unless otherwise specified. Single phase, half wave, 60Hz, resistive or inductive load. For capacitive load, derate current by 20%.

#### ■ Outline

TO-277

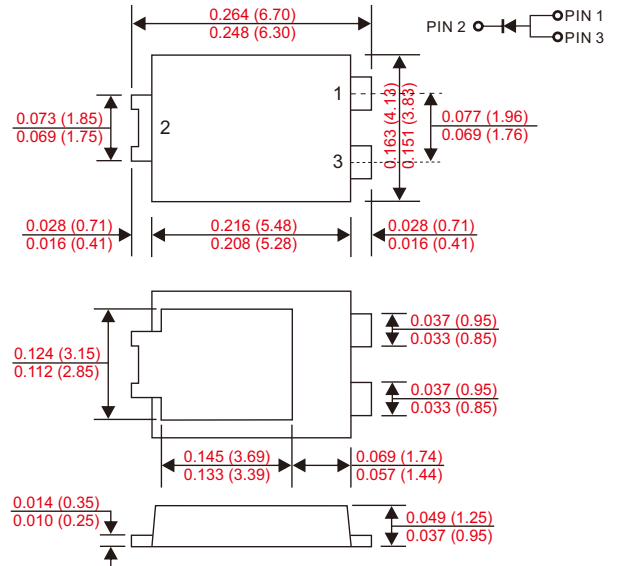

Dimensions in inches and (millimeters)

Parameter	Conditions	Symbol	CSP1045S-A	UNIT
Marking code			CSP1045S	
Peak repetitive reverse voltage		$V_{RRM}$	45	V
Working peak reverse voltage		$V_{RWM}$		
DC blocking voltage		$V_{RM}$		
RMS reverse voltage		$V_{R(RMS)}$	32	V
Forward rectified current		$I_O$	10	A
Forward surge current	8.3ms single half sine-wave superimposed on rate load (JEDEC method)	$I_{FSM}$	200	A
Thermal resistance	Junction to case	$R_{\theta JC}$	4	°C/W
Operating and Storage temperature		$T_J, T_{STG}$	-55 ~ +150	°C

Parameter	Conditions	Symbol	MIN.	TYP.	MAX.	UNIT
Reverse breakdown voltage	$I_R = 0.5mA$	$V_{(BR)R}$	45			V
Forward voltage drop	$I_F = 8A, T_J = 25^\circ C$	$V_F$			510	mV
	$I_F = 10A, T_J = 25^\circ C$				550	
	$I_F = 10A, T_J = 125^\circ C$			480	530	
Reverse current	$V_R = V_{RRM}, T_J = 25^\circ C$	$I_R$			0.45	mA
	$V_R = V_{RRM}, T_J = 100^\circ C$				18	
	$V_R = V_{RRM}, T_J = 125^\circ C$				100	

Note : 1.FR-4 PCB, 2oz.Copper.  
2.Polyimide PCB, 2oz.Copper.Cathode pad dimensions 18.8mm x 14.4mm.Anode pad dimensions 5.6mm x 14.4mm.

Rating and characteristic curves

Fig. 1 - Forward Power Dissipation

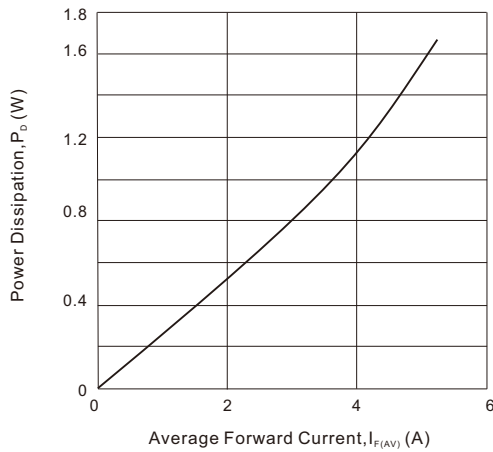

Fig. 2 - Instantaneous Forward Characteristics

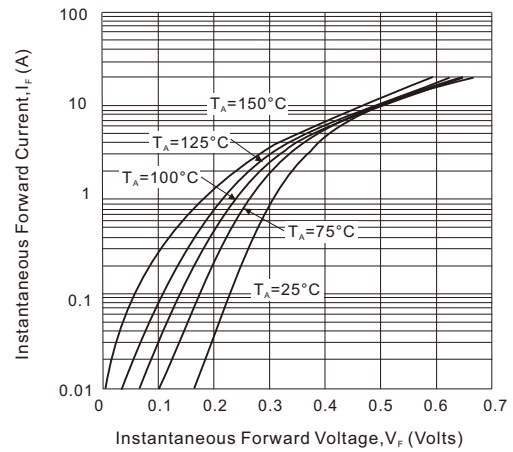

Fig. 3 - Reverse Characteristics

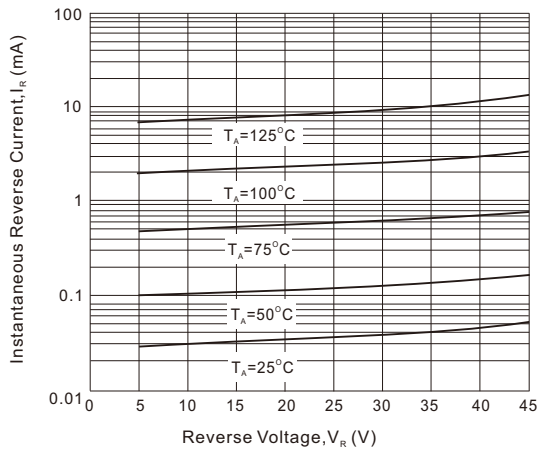

Fig. 4 - Forward Current Derating Curve

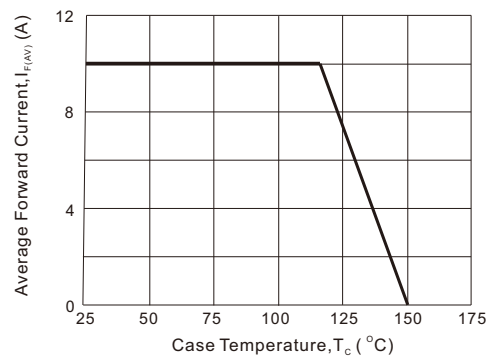

Fig. 5 - Total Capacitance VS. Reverse Voltage

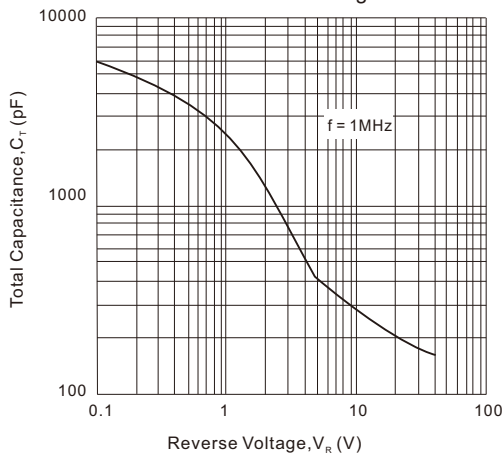
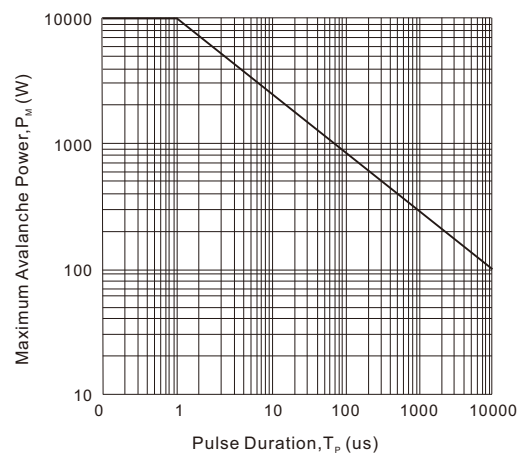
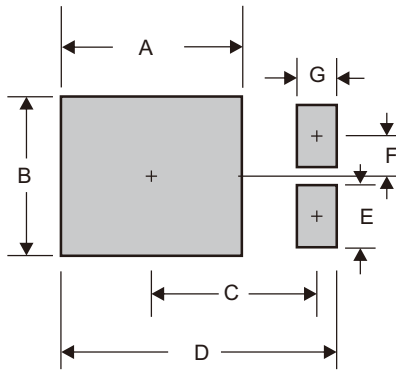

Fig. 6 - Maximum Avalanche Power Curve



■ TO-277 foot print



A	B	C	D	E	F	G
0.185 (4.70)	0.142 (3.60)	0.152 (3.87)	0.260 (6.60)	0.055 (1.40)	0.035 (0.90)	0.031 (0.80)

Dimensions in inches and (millimeters)

- CITC reserves the right to make changes to this document and its products and specifications at any time without notice.
- Customers should obtain and confirm the latest product information and specifications before final design, purchase or use.
- CITC makes no warranty, representation or guarantee regarding the suitability of its products for any particular purpose, nor does CITC assume any liability for application assistance or customer product design.
- CITC does not warrant or accept any liability with products which are purchased or used for any unintended or unauthorized application.
- No license is granted by implication or otherwise under any intellectual property rights of CITC.
- CITC products are not authorized for use as critical components in life support devices or systems without express written approval of CITC.