



<b>Spec. No.</b>	PS-ND-0710
<b>Rev.</b>	A

# PRODUCT SPECIFICATION

**Model No : CSS-2318VM9/2319VM9**

Descriptions:
<ul style="list-style-type: none"> <li>■ 2.3 Inch Single Digit Display</li> <li>■ Emitting Color : Super Bright Orange &amp; Super Bright Green</li> </ul>



CUSTOMER APPROVED SIGNATURES	APPROVED BY	CHECKED BY	PREPARED BY

**CHINA SEMICONDUCTOR CORPORATION**  
Address: 2FL. NO.909, Chung-Cheng Road,  
Chung-Ho City Taipei Hsien, Taiwan.

Tel: 886-2-2223-9696  
Fax: 886-2-2223-9377

**OPTO PLUS TECHNOLOGIES CO.,LTD**  
Address: 696 Shun jiang Rd., Ji Shan St. Shaoxing,  
ZheJiang, China

Tel: 86-0575-88623888  
Fax: 86-0575-88623112



<b>Spec. No.</b>	PS-ND-0710
<b>Rev.</b>	A

**Model No : CSS-2318VM9/2319VM9**

**■ Features -**

1. 2.3 inch (56.8mm) digit height.
2. Case mold type.
3. RoHS compliant.
4. Low power consumption.
5. Easy mounting on P.C. board or socket.

**■ Device Selection Guide -**

Part No.	Chip		Description
	Material	Emitted Color	
CSS-2318VM9	AlGaInP	Super-Bright Orange	Common Anode
	AlGaInP	Super-Bright Green	
CSS-2319VM9	AlGaInP	Super-Bright Orange	Common Cathode
	AlGaInP	Super-Bright Green	

**■ Mechanical Dimensions -**

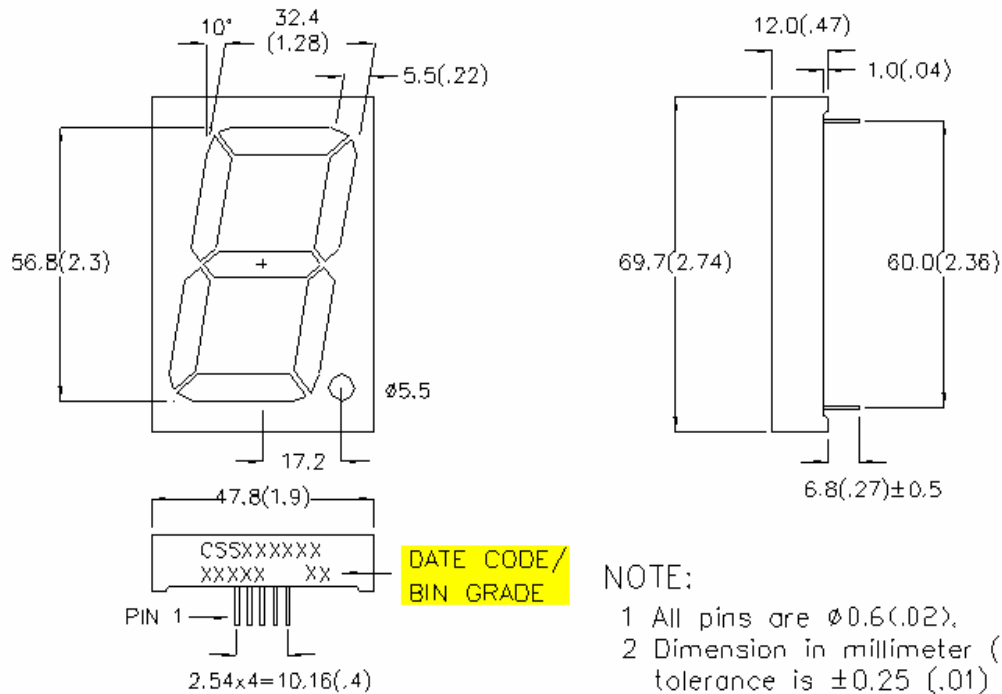

**NOTE:**  
 1 All pins are  $\phi 0.6(0.02)$ .  
 2 Dimension in millimeter (inch), and tolerance is  $\pm 0.25 (.01)$  unless otherwise noted.



<b>Spec. No.</b>	PS-ND-0710
<b>Rev.</b>	A

**Model No : CSS-2318VM9/2319VM9**

**Internal Circuit Diagrams -**

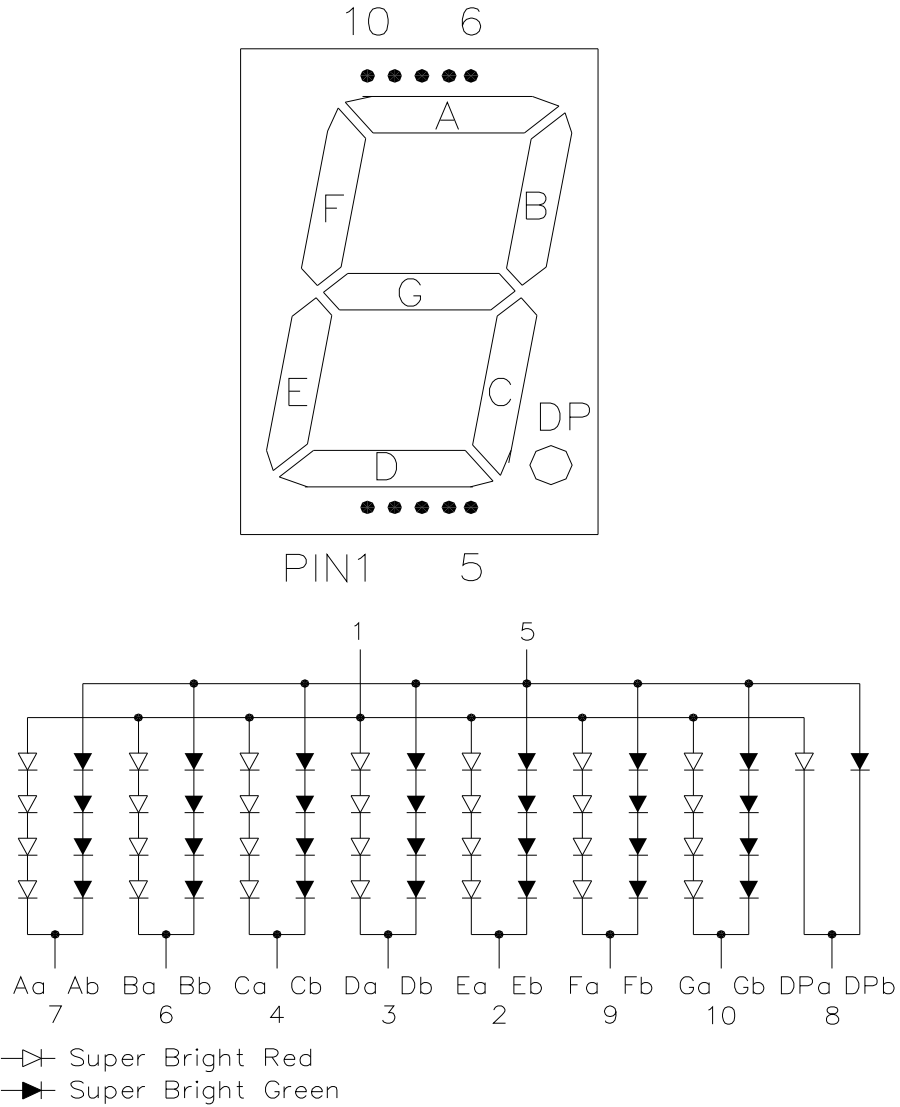

**CSS-2318 Common Anode  
(CSS-2319 Common Cathode.)**

**Model No : CSS-2318VM9/2319VM9**
**■ Absolute Maximum Rating -**

(Ta=25°C)

Parameter	Symbol	Super-Bright Orange	Unit
Power Dissipation Per Dice	Pd	70	mW
Continuous Forward Current Per Dice	IAF	25	mA
Peak Current Per Dice	IPF	90	mA
Reverse Voltage Per Dice	VR	5	V
Operating Temperature	Topr	-35 ~ +85	°C
Storage Temperature	Tstg	-35 ~ +85	°C

Solder emperature 1/16 inch below seating plane for 3 seconds at 260°C

**■ Electro-optical Characteristics -**

(Ta=25°C)

Parameter	Symbol	Min.	Typ.	Max.	Unit	Condition
Forward Voltage Per Segment (DP)	VF	-	8.0(2.0)	11.2(2.8)	V	IF=20mA
Luminous Intensity Per Dot	Iv	-	70	-	mcd	IF=10mA
Peak Emission Wavelength	$\lambda P$	-	632	-	nm	IF=20mA
Spectrum Radiation Bandwidth	$\Delta \lambda$	-	20	-	nm	IF=20mA
Reverse Current	IR	-	-	100	$\mu A$	VR=16V
Luminous Intensity Matching Ratio	IV-m	-	-	2:1		IF=20mA



<b>Spec. No.</b>	PS-ND-0710
<b>Rev.</b>	A

**Model No : CSS-2318VM9/2319VM9**

■ **Absolute Maximum Rating -**

(Ta=25°C)

Parameter	Symbol	Super-Bright Green	Unit
Power Dissipation Per Dice	Pd	70	mW
Continuous Forward Current Per Dice	IAF	25	mA
Peak Current Per Dice	IPF	90	mA
Reverse Voltage Per Dice	VR	5	V
Operating Temperature	Topr	-35 ~ +85	°C
Storage Temperature	Tstg	-35 ~ +85	°C
Solder emperature 1/16 inch below seating plane for 3 seconds at 260°C			

■ **Electro-optical Characteristics -**

(Ta=25°C)

Parameter	Symbol	Min.	Typ.	Max.	Unit	Condition
Forward Voltage Per Segment (DP)	VF	-	8.4(2.1)	11.2(2.8)	V	IF=20mA
Luminous Intensity Per Dot	Iv	-	40	-	mcd	IF=10mA
Peak Emission Wavelength	$\lambda P$	-	570	-	nm	IF=20mA
Spectrum Radiation Bandwidth	$\Delta \lambda$	-	20	-	nm	IF=20mA
Reverse Current	IR	-	-	100	$\mu A$	VR=16V
Luminous Intensity Matching Ratio	IV-m	-	-	2:1		IF=20mA



<b>Spec. No.</b>	PS-ND-0710
<b>Rev.</b>	A

**Model No : CSS-2318VM9/2319VM9**

**Typical Electrical / Optical Characteristics Curves -Orange**  
(Ta = 25°C Unless Otherwise Noted)

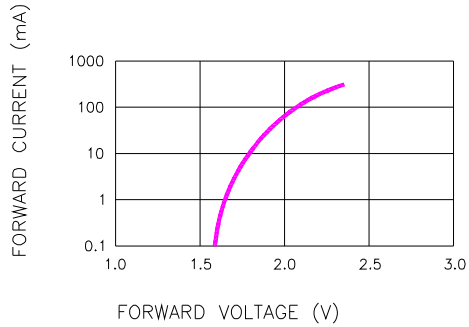

Fig.1 FORWARD CURRENT VS. FORWARD VOLTAGE

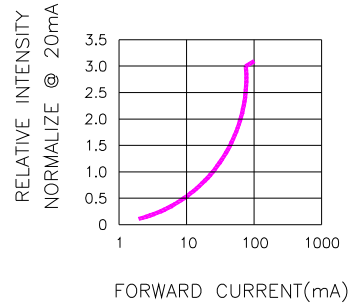

Fig.2 RELATIVE INTENSITY VS. FORWARD CURRENT

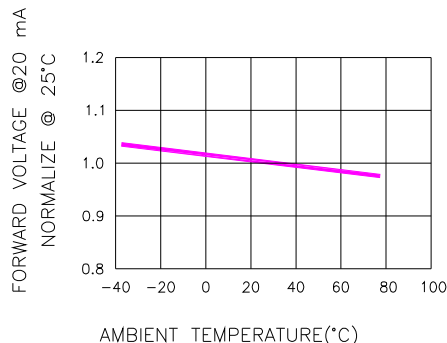

Fig.3 FORWARD VOLTAGE VS. TEMPERATURE

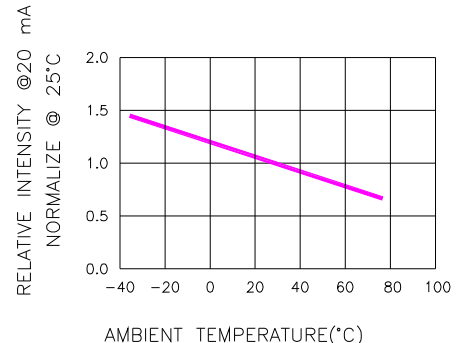

Fig.4 RELATIVE INTENSITY VS. TEMPERATURE

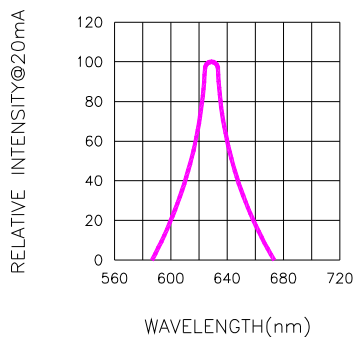

Fig.5 RELATIVE INTENSITY VS. WAVELENGTH



<b>Spec. No.</b>	PS-ND-0710
<b>Rev.</b>	A

**Model No : CSS-2318VM9/2319VM9**

**Typical Electrical / Optical Characteristics Curves -Yellow-Green  
(Ta = 25°C Unless Otherwise Noted)**

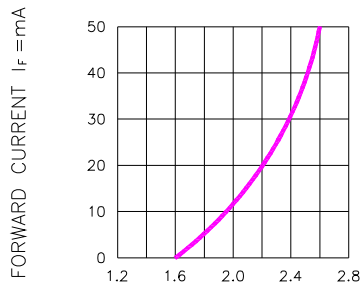

FORWARD VOLTAGE (V<sub>F</sub>)-VOLTS  
Fig.1 FORWARD CURRENT VS. FORWARD VOLTAGE

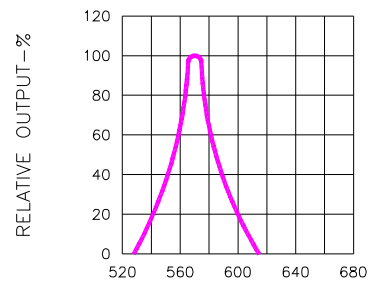

WAVELENGTH (λ)-nm  
Fig.2 SPECTRAL RESPONSE

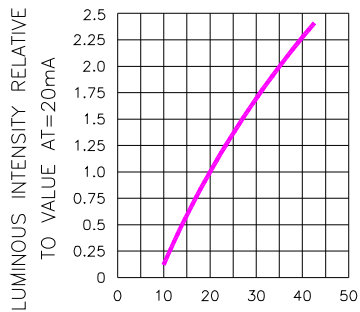

I<sub>F</sub>-FORWARD CURRENT-mA  
Fig.3 RELATIVE LUMINOUS INTENSITY VS. FORWARD CURRENT

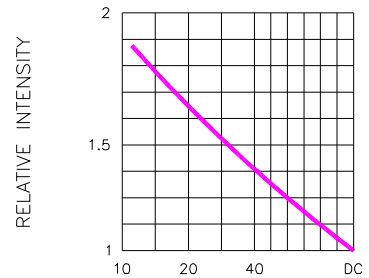

DUTY CYCLE % PER SEGMENT  
(AVERAGE I<sub>F</sub>=10mA)  
Fig.5 LUMINOUS INTENSITY VS. DUTY CYCLE

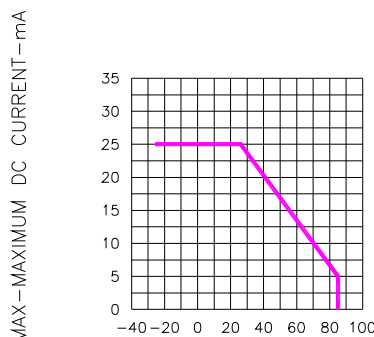

T<sub>A</sub> AMBIENT TEMPERATURE °C  
Fig.4 MAXIMUM ALLOWABLE DC CURRENT PER SEGMENT VS. A FUNCTION OF AMBIENT TEMPERATURE

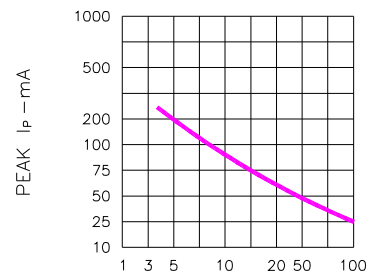

Fig.6 MAX PEAK CURRENT VS. DUTY CYCLE %  
(REFRESH RATE f=1 KHz)



<b>Spec. No.</b>	PS-ND-0710
<b>Rev.</b>	A

**Model No : CSS-2318VM9/2319VM9**

■ Package Dimensions

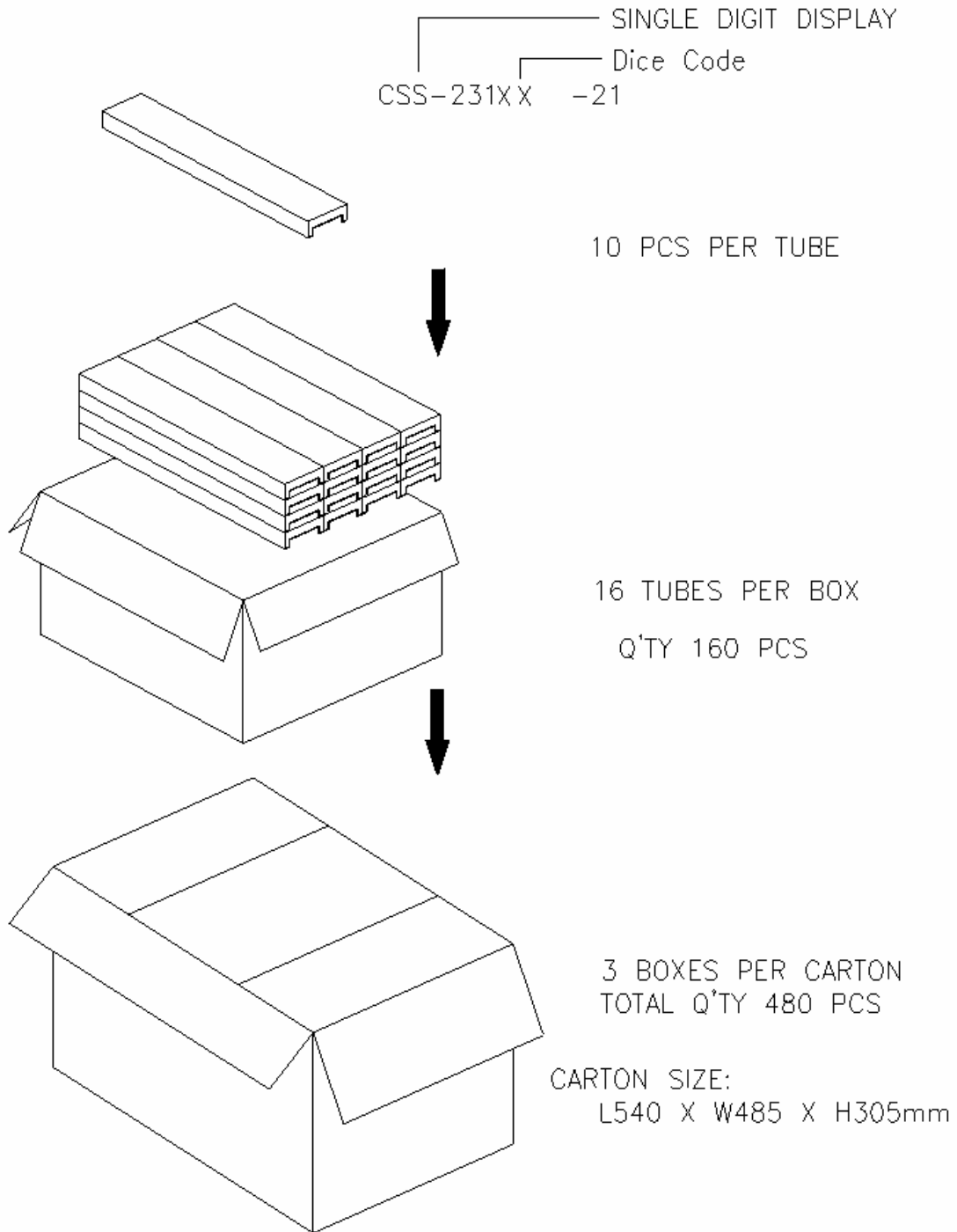

Note: The specifications are subject to change without notice. Please contact us for updated informatic