



CST3020 N-Ch and P-Ch Fast Switching MOSFETs

- ★ 100% EAS Guaranteed
- ★ Green Device Available
- ★ Super Low Gate Charge
- ★ Excellent CdV/dt effect decline
- ★ Advanced high cell density Trench technology

CST3020 Product Summary



BVDSS	RDSON	ID
30V	15 mΩ	20A
-30V	25 mΩ	-23A

CST3020 Description

The CST3020 is the high performance complementary N-ch and P-ch MOSFETs with high cell density, which provide excellent RDSON and gate charge for most of the synchronous buck converter applications. The CST3020 meet the RoHS and Green Product requirement 100% EAS guaranteed with full function reliability approved.

CST3020 TO252-4 Pin Configuration

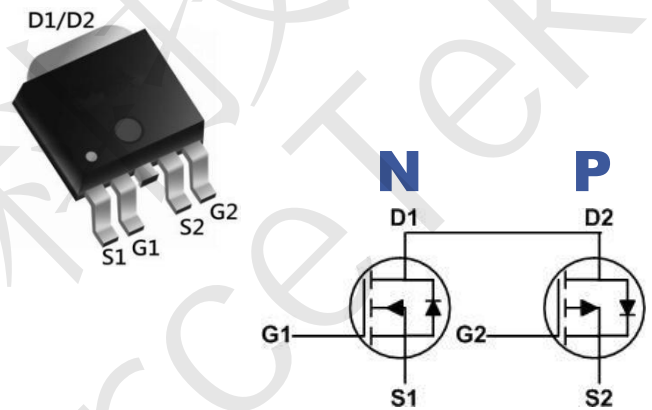

CST3020 Absolute Maximum Ratings

Symbol	Parameter	Rating		Units
		N-Ch	P-Ch	
V_{DS}	Drain-Source Voltage	30	-30	V
V_{GS}	Gate-Source Voltage	± 20	± 20	V
$I_D@T_C=25^\circ C$	Continuous Drain Current, $V_{GS} @ 10V^1$	20	- 23	A
$I_D@T_C=100^\circ C$	Continuous Drain Current, $V_{GS} @ 10V^1$	15	-14	A
I_{DM}	Pulsed Drain Current ²	60	-60	A
EAS	Single Pulse Avalanche Energy ³	26.6	38	mJ
$P_D@T_C=25^\circ C$	Total Power Dissipation ⁴	20.8	20.8	W
$P_D@T_A=25^\circ C$	Total Power Dissipation ⁴	2	2	W
T_{STG}	Storage Temperature Range	-55 to 150	-55 to 150	$^\circ C$
T_J	Operating Junction Temperature Range	-55 to 150	-55 to 150	$^\circ C$

Symbol	Parameter	Typ.	Max.	Unit
$R_{\theta JA}$	Thermal Resistance Junction-Ambient ¹	---	62	$^\circ C/W$
$R_{\theta JC}$	Thermal Resistance Junction-Case ¹	---	6	$^\circ C/W$



CST3020 N-Ch and P-Ch Fast Switching MOSFETs

CST3020 N-Channel Electrical Characteristics (T_J=25 °C, unless otherwise noted)

Symbol	Parameter	Conditions	Min.	Typ.	Max.	Unit
BV _{DSS}	Drain-Source Breakdown Voltage	V _{GS} =0V, I _D =250uA	30	---	---	V
ΔBV _{DSS} /ΔT _J	BVDSS Temperature Coefficient	Reference to 25°C, I _D =1mA	---	0.023	---	V/°C
R _{DS(ON)}	Static Drain-Source On-Resistance ²	V _{GS} =10V, I _D =10A	---	15	20	mΩ
		V _{GS} =4.5V, I _D =6A	---	20	25	
V _{GS(th)}	Gate Threshold Voltage	V _{GS} =V _{DS} , I _D =250uA	1.0	---	2.5	V
ΔV _{GS(th)}	V _{GS(th)} Temperature Coefficient		---	-4.2	---	mV/°C
I _{DSS}	Drain-Source Leakage Current	V _{DS} =24V, V _{GS} =0V, T _J =25°C	---	---	1	uA
		V _{DS} =24V, V _{GS} =0V, T _J =55°C	---	---	5	
I _{GSS}	Gate-Source Leakage Current	V _{GS} =±20V, V _{DS} =0V	---	---	±100	nA
g _{fs}	Forward Transconductance	V _{DS} =5V, I _D =10A	---	14	---	S
R _g	Gate Resistance	V _{DS} =0V, V _{GS} =0V, f=1MHz	---	2.3	---	Ω
Q _g	Total Gate Charge (4.5V)	V _{DS} =20V, V _{GS} =4.5V, I _D =10A	---	5	---	nC
Q _{gs}	Gate-Source Charge		---	1.11	---	
Q _{gd}	Gate-Drain Charge		---	2.61	---	
T _{d(on)}	Turn-On Delay Time	V _{DD} =12V, V _{GS} =10V, R _G =3.3Ω I _D =6A	---	7.7	---	ns
T _r	Rise Time		---	46	---	
T _{d(off)}	Turn-Off Delay Time		---	11	---	
T _f	Fall Time		---	3.6	---	
C _{iss}	Input Capacitance	V _{DS} =15V, V _{GS} =0V, f=1MHz	---	416	---	pF
C _{oss}	Output Capacitance		---	62	---	
C _{rss}	Reverse Transfer Capacitance		---	51	---	

CST3020 Diode Characteristics

Symbol	Parameter	Conditions	Min.	Typ.	Max.	Unit
I _S	Continuous Source Current ^{1,5}	V _G =V _D =0V, Force Current	---	---	20	A
I _{SM}	Pulsed Source Current ^{2,5}		---	---	40	A
V _{SD}	Diode Forward Voltage ²	V _{GS} =0V, I _S =1A, T _J =25°C	---	---	1.2	V

Note :

1. The data tested by surface mounted on a 1 inch² FR-4 board with 20Z copper.
2. The data tested by pulsed, pulse width ≤ 300us, duty cycle ≤ 2%
3. The EAS data shows Max. rating. The test condition is V_{DD}=25V, V_{GS}=10V, L=0.1mH, I_{AS}=12.7A
4. The power dissipation is limited by 150°C junction temperature
5. The data is theoretically the same as I_D and I_{DM}, in real applications, should be limited by total power dissipation.



CST3020 N-Ch and P-Ch Fast Switching MOSFETs

CST3020 P-Channel Electrical Characteristics (T_J=25 °C, unless otherwise noted)

Symbol	Parameter	Conditions	Min.	Typ.	Max.	Unit
BV _{DSS}	Drain-Source Breakdown Voltage	V _{GS} =0V, I _D =-250uA	-30	---	---	V
ΔBV _{DSS} /ΔT _J	BV _{DSS} Temperature Coefficient	Reference to 25°C, I _D =-1mA	---	-0.021	---	V/°C
R _{DS(ON)}	Static Drain-Source On-Resistance ²	V _{GS} =-10V, I _D =-8A	---	25	30	mΩ
		V _{GS} =-4.5V, I _D =-6A	---	30	35	
V _{GS(th)}	Gate Threshold Voltage	V _{GS} =V _{DS} , I _D =-250uA	-1.0	---	-2.5	V
ΔV _{GS(th)}	V _{GS(th)} Temperature Coefficient		---	-4.2	---	mV/°C
I _{DSS}	Drain-Source Leakage Current	V _{DS} =-24V, V _{GS} =0V, T _J =25°C	---	---	1	uA
		V _{DS} =-24V, V _{GS} =0V, T _J =55°C	---	---	5	
I _{GSS}	Gate-Source Leakage Current	V _{GS} =±20V, V _{DS} =0V	---	---	±100	nA
g _{fs}	Forward Transconductance	V _{DS} =-5V, I _D =-8A	---	12.6	---	S
R _g	Gate Resistance	V _{DS} =0V, V _{GS} =0V, f=1MHz	---	15	---	Ω
Q _g	Total Gate Charge (-4.5V)	V _{DS} =-20V, V _{GS} =-4.5V, I _D =-6A	---	9.8	---	nC
Q _{gs}	Gate-Source Charge		---	2.2	---	
Q _{gd}	Gate-Drain Charge		---	3.4	---	
T _{d(on)}	Turn-On Delay Time	V _{DD} =-24V, V _{GS} =-10V, R _G =3.3Ω, I _D =-1A	---	16.4	---	ns
T _r	Rise Time		---	20.2	---	
T _{d(off)}	Turn-Off Delay Time		---	55	---	
T _f	Fall Time		---	10	---	
C _{iss}	Input Capacitance	V _{DS} =-15V, V _{GS} =0V, f=1MHz	---	930	---	pF
C _{oss}	Output Capacitance		---	148	---	
C _{rss}	Reverse Transfer Capacitance		---	115	---	

CST3020 Diode Characteristics

Symbol	Parameter	Conditions	Min.	Typ.	Max.	Unit
I _S	Continuous Source Current ^{1,5}	V _G =V _D =0V, Force Current	---	---	-23	A
I _{SM}	Pulsed Source Current ^{2,5}		---	---	-35	A
V _{SD}	Diode Forward Voltage ²	V _{GS} =0V, I _S =-1A, T _J =25°C	---	---	-1.2	V

Note :

- The data tested by surface mounted on a 1 inch² FR-4 board with 20Z copper.
- The data tested by pulsed, pulse width ≤ 300us, duty cycle ≤ 2%
- The EAS data shows Max. rating. The test condition is V_{DD}=-25V, V_{GS}=-10V, L=0.1mH, I_{AS}=-30A
- The power dissipation is limited by 150°C junction temperature
- The data is theoretically the same as I_D and I_{DM}, in real applications, should be limited by total power dissipation.



CST3020 N-Ch and P-Ch Fast Switching MOSFETs

CST3020 N-Channel Typical Characteristics

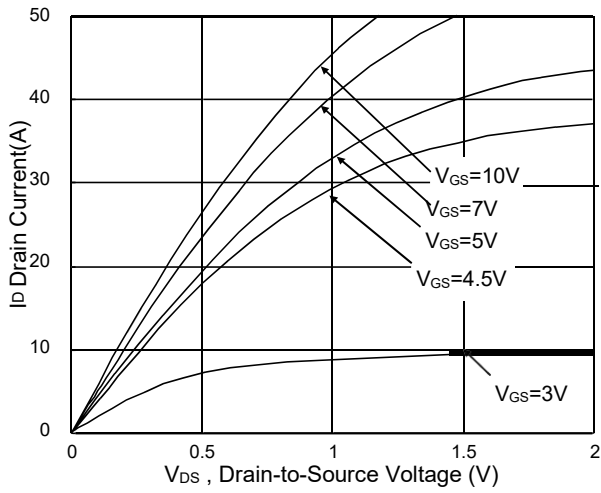

Fig.1 Typical Output Characteristics

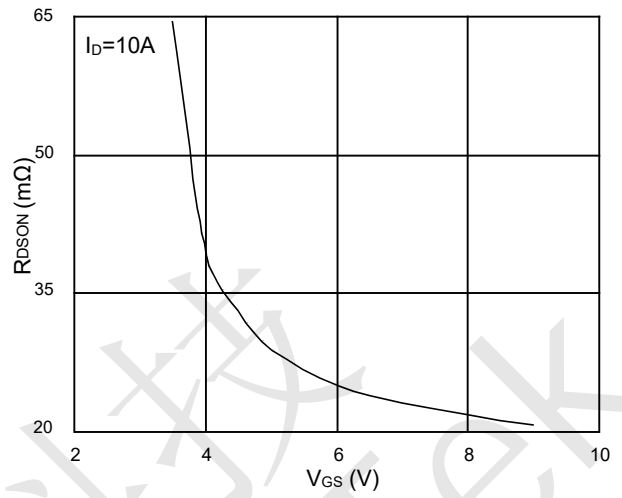

Fig.2 On-Resistance vs. Gate-Source

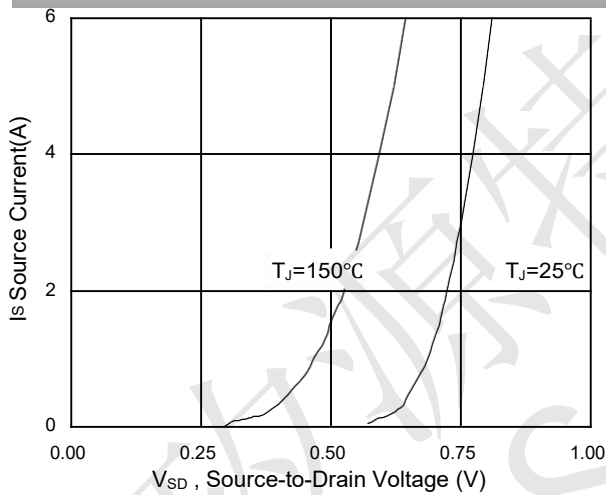

Fig.3 Forward Characteristics Of Reverse

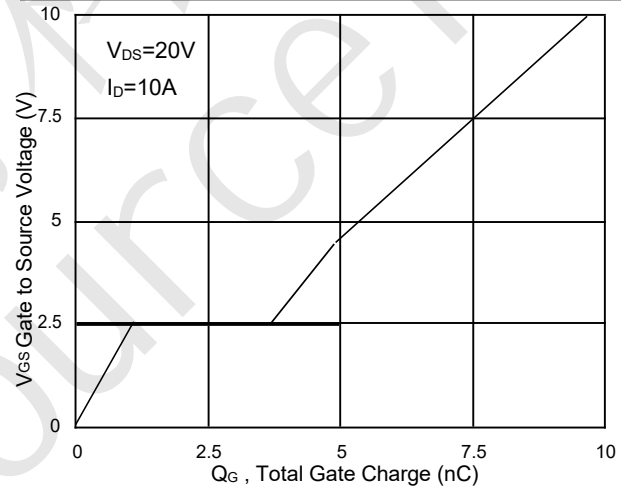

Fig.4 Gate-Charge Characteristics

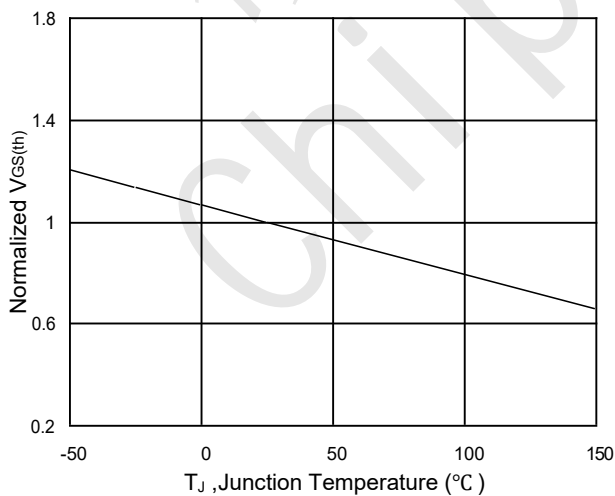

Fig.5 Normalized $V_{GS(th)}$ vs. T_J

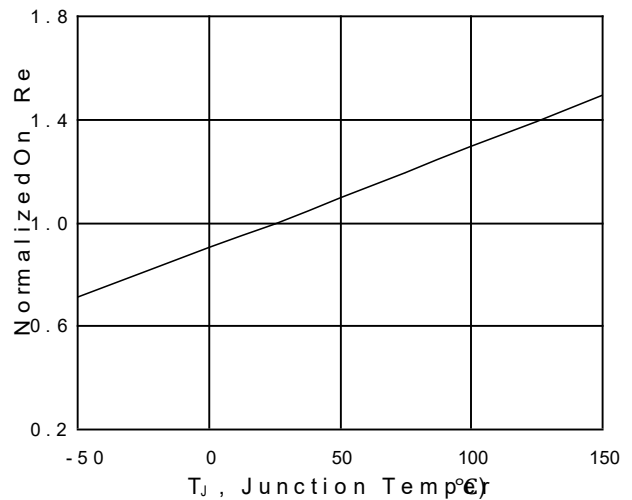

Fig.6 Normalized $R_{DS(on)}$ vs. T_J



CST3020 N-Ch and P-Ch Fast Switching MOSFETs

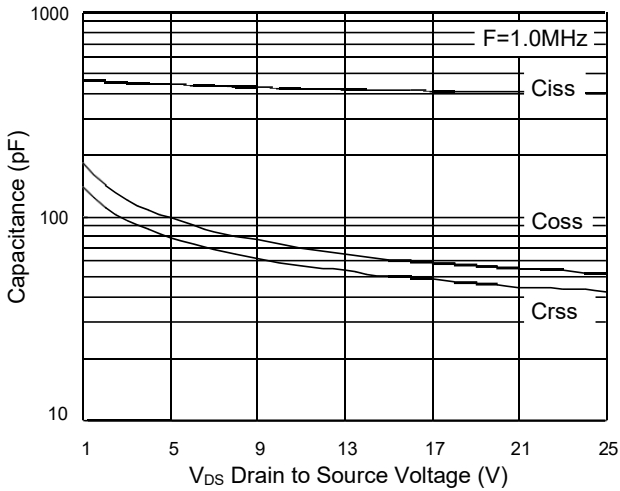

Fig.7 Capacitance

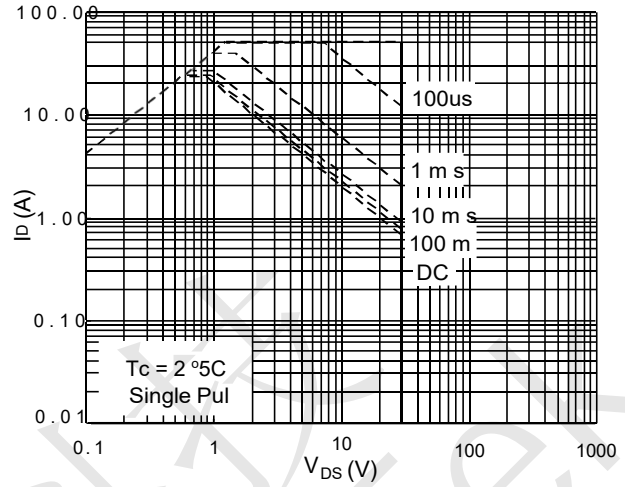

Fig.8 Safe Operating Area

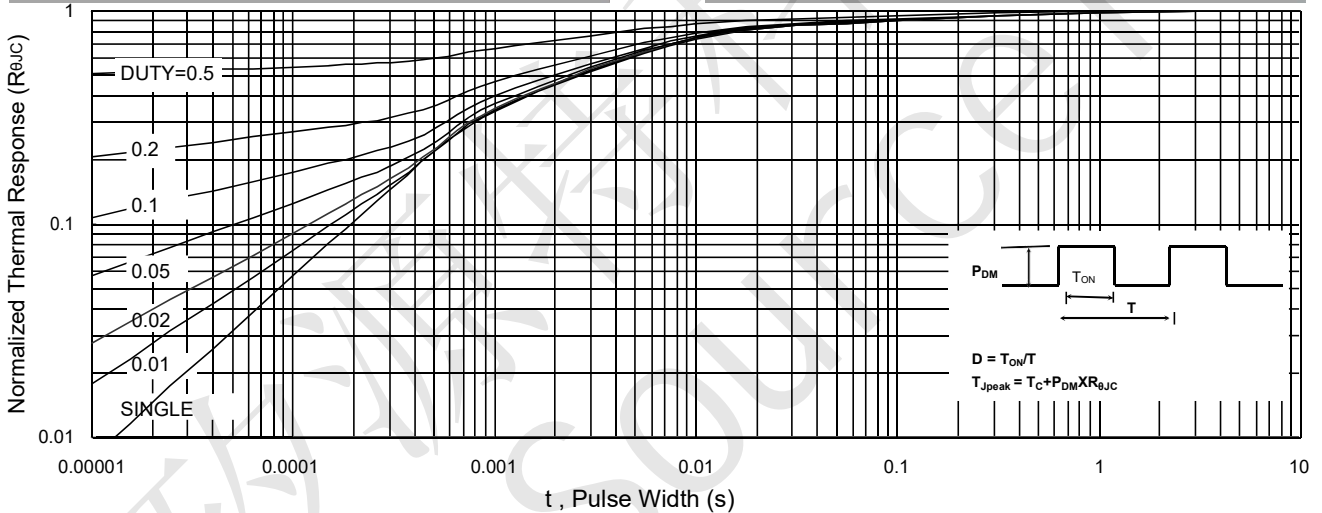
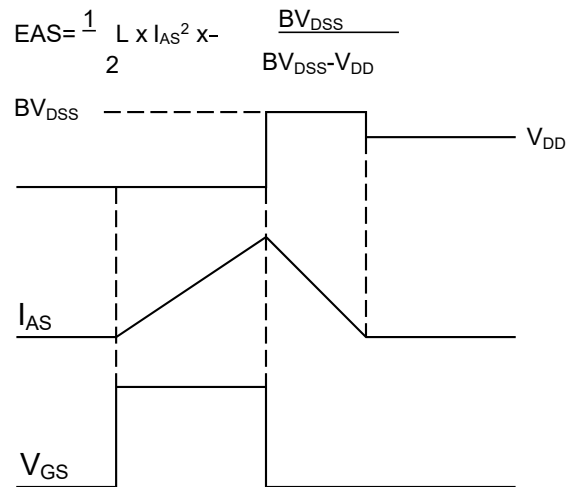
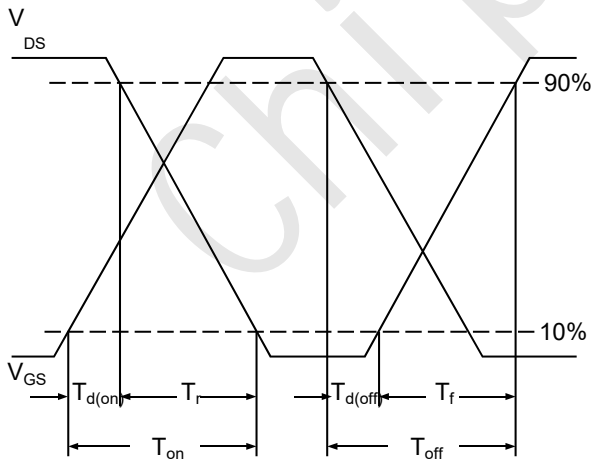

Fig.9 Normalized Maximum Transient Thermal Impedance





CST3020 N-Ch and P-Ch Fast Switching MOSFETs

CST3020 P-Channel Typical Characteristics

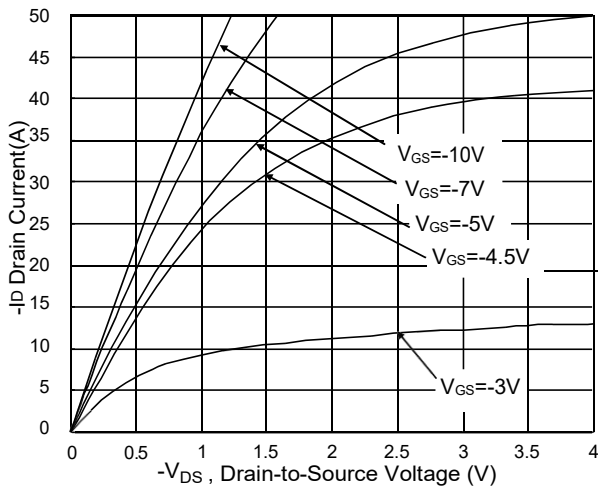

Fig.1 Typical Output Characteristics

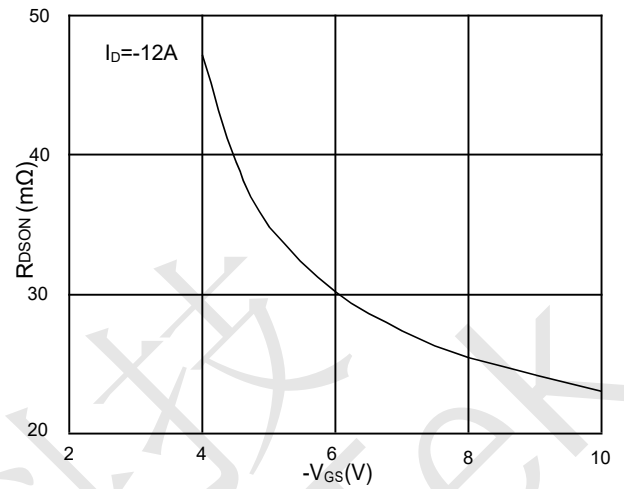

Fig.2 On-Resistance v.s Gate-Source

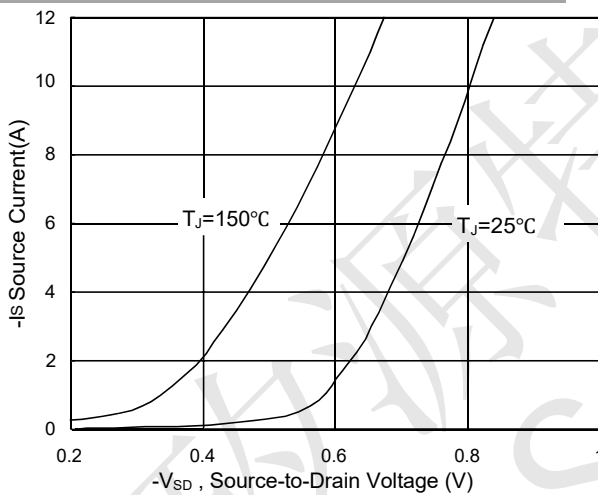

Fig.3 Forward Characteristics Of Reverse

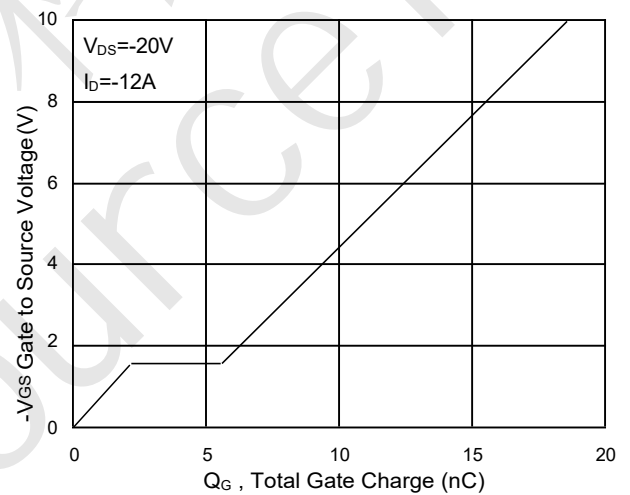

Fig.4 Gate-Charge Characteristics

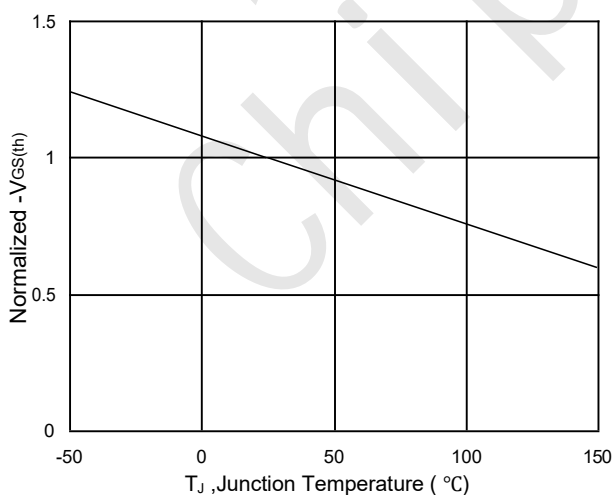

Fig.5 Normalized $V_{GS(th)}$ v.s T_J

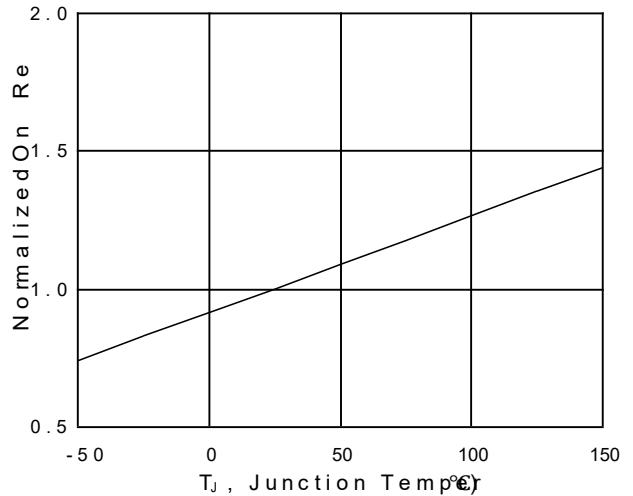

Fig.6 Normalized $R_{DS(on)}$ v.s T_J



CST3020 N-Ch and P-Ch Fast Switching MOSFETs

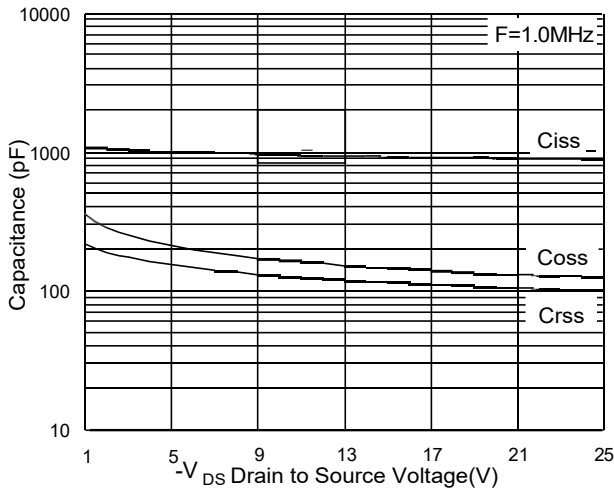

Fig.7 Capacitance

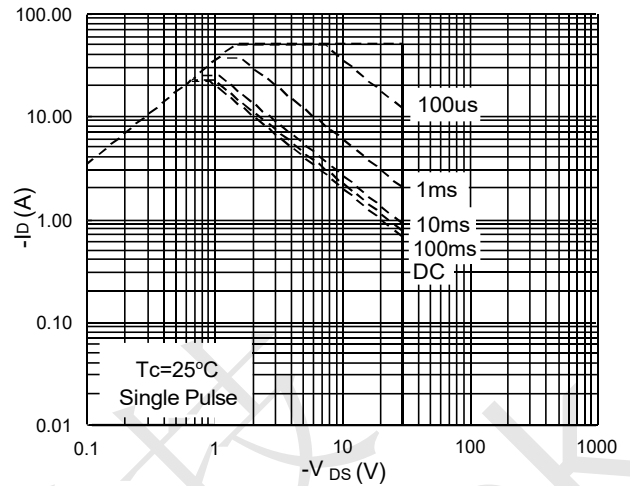

Fig.8 Safe Operating Area

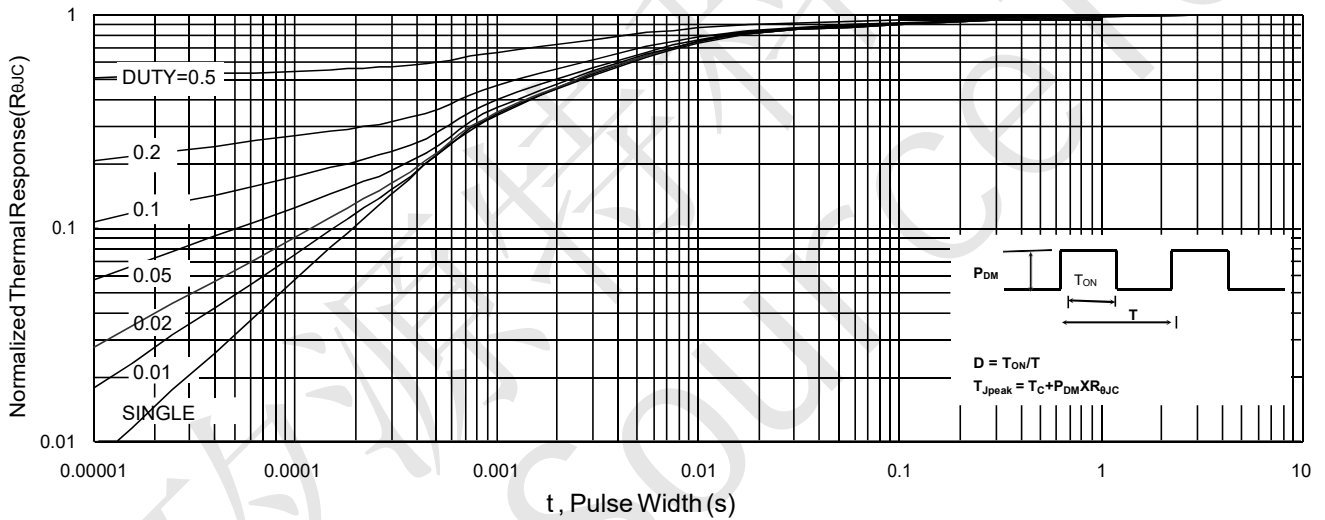

Fig.9 Normalized Maximum Transient Thermal Impedance

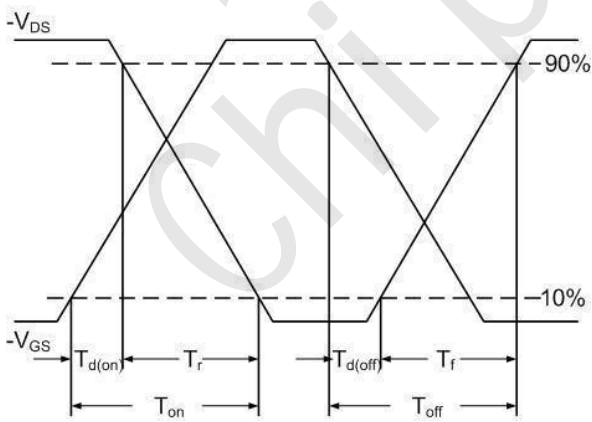

Fig.10 Switching Time Waveform

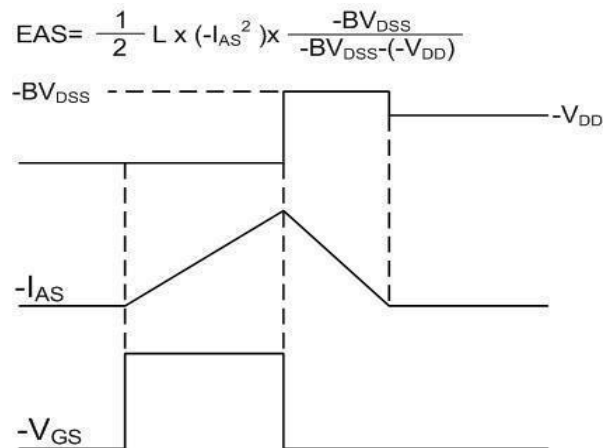

Fig.11 Unclamped Inductive Switching Waveform



CST3020 N-Ch and P-Ch Fast Switching MOSFETs

