



Features

- High isolation 5000 VRMS
- Patented coplanar structure DMC-Isolator®
- Peak Breakdown Voltage
 - 600V – CT3061-4L, CT3062-4L, CT3063-4L
 - 800V – CT3081-4L, CT3082-4L, CT3083-4L
- Operating Temperature range - 55 °C to 100 °C
- External Creepage $\geq 7.4\text{mm}$
- Distance Through Isolation $\geq 0.4\text{mm}$
- Clearance Distance $\geq 7.5\text{mm}$ (S/SL Type)
- Clearance Distance $\geq 8.0\text{mm}$ (M Type)
- RoHS and REACH Compliance
- Halogen Free Compliance (Optional)
- MSL class 1
- Regulatory Approvals
 - ✓ UL - UL1577 (E364000)
 - ✓ VDE - EN60747-5-5 (40039590)
 - ✓ CQC – GB4943.1, GB8898(14001104781)
 - ✓ IEC62368 (FI/41119)

Description

The CT3061-4L, CT3062-4L, CT3063-4L, CT3081-4L, CT3082-4L and CT3083-4L series consists of a Zero Cross Photo Triac optically coupled to an Infrared-emitting diode in a 4-lead DIP package DMC-Isolator® package with different lead forming options.

Applications

- Motor Controls
- Lamp ballasts
- Static AC Power Switch
- Solenoid/ Valve Control

Package Outline

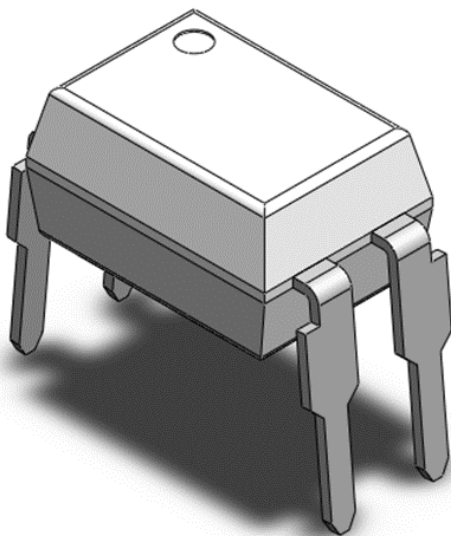

Note: Different lead forming options available. See package dimension.

Schematic

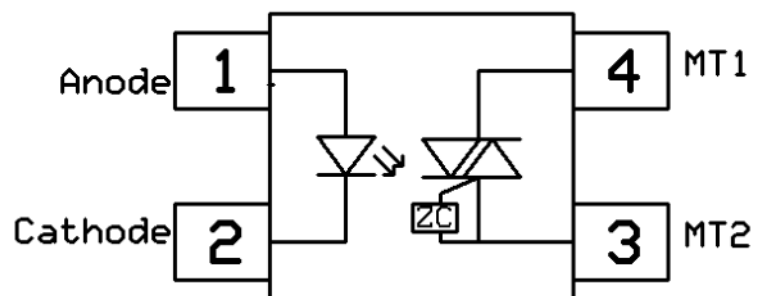



Absolute Maximum Ratings $T_A = 25^{\circ}\text{C}$, unless otherwise specified

Stresses in excess of the absolute maximum ratings can cause permanent damage to the device. Functional operation of the device is not implied at these or any other conditions in excess of those given in the operational sections of this document. In addition, extended exposure to stresses above the recommended operating conditions may affect device reliability. The absolute maximum ratings are stress ratings only.

Symbol	Parameters		Ratings	Units	Notes
V _{ISO}	Isolation voltage (AC, 1 minute, 40 ~ 60% R.H.)		5000	V _{RMS}	
T _{OPR}	Operating temperature		-55 ~ +100	°C	
T _{STG}	Storage temperature		-55 ~ +150	°C	
T _{SOL}	Soldering temperature (For 10 seconds)		260	°C	
T _J	Junction temperature		115		
Emitter					
I _F	Forward current		60	mA	
I _{F(TRANS)}	Peak transient current (≤1μs P.W,300pps)		1	A	
V _R	Reverse voltage		6	V	
P _D	Power dissipation		100	mW	
Detector					
P _D	Power dissipation		300	mW	
V _{DRM}	Off-State Output Terminal Voltage	CT3061-4L,3062-4L,3063-4L	600	V	
		CT3081-4L,3082-4L,3083-4L	800	V	
I _{TM}	RMS on-state current		100	A	
I _{TSM}	Peak Repetitive Surge Current		1		



Electrical Characteristics $T_A = 25^\circ\text{C}$, unless otherwise specified

Emitter Characteristics

Symbol	Parameters	Test Conditions	Min	Typ	Max	Units	Notes
V_F	Forward voltage	$I_F = 10\text{mA}$		1.24	1.5	V	
I_R	Reverse Current	$V_R = 6\text{V}$	-	-	5	μA	
C_{IN}	Input Capacitance	$f = 1\text{MHz}$	-	45	-	pF	

Detector Characteristics

Symbol	Parameters	Test Conditions	Min	Typ	Max	Units	Notes
I_{DRM1}	Peak Blocking Current	$I_F = 0\text{mA}$, $V_{DRM} = \text{Rated } V_{DRM}$	-	-	500	nA	
I_{DRM2}	Inhibit Leakage Current	$I_F = \text{Rated } I_{FT}$, $V_{DRM} = \text{Rated } V_{DRM}$			500	μA	
V_{INH}	Inhibit Voltage	$I_F = \text{Rated } I_{FT}$			20	V	
V_{TM}	Peak On-State Voltage	$I_F = \text{Rated } I_{FT}$, $I_{TM} = 100\text{mA}$	-	-	3	V	
dv/dt	Critical Rate of Rise off-State Voltage	CT3061-4L, CT3062-4L, CT3063-4L	$V_{PEAK} = \text{Rated } V_{DRM}$	1000	-	-	V/ μs
		CT3081-4L, CT3082-4L, CT3083-4L		600	-	-	

Transfer Characteristics

Symbol	Parameters	Test Conditions	Min	Typ	Max	Units	Notes				
I_{FT}	Input	Terminal Voltage = 3V $I_{TM} = 100\text{mA}$				mA					
	Trigger							CT3061-4L, CT3081-4L	-	-	15
	Current							CT3062-4L, CT3082-4L CT3063-4L CT3083-4L	-	-	10
I_H	Holding Current	Terminal Voltage from "ON" to "OFF" "ON" state $I_F = 0\text{mA}$	-	380	-	μA					
R_{IO}	Isolation Resistance	$V_{IO} = 500\text{V}_{DC}$, 40 ~ 60% R.H.	1×10^{11}			Ω					
C_{IO}	Isolation Capacitance	$f = 1\text{MHz}$		0.25		pF					



Typical Characteristic Curves $T_A = 25^\circ\text{C}$, unless otherwise specified

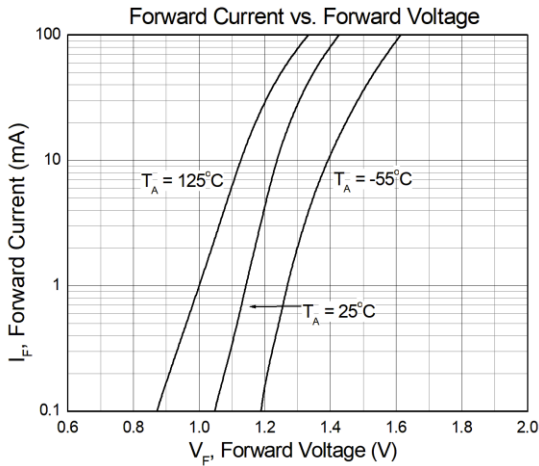

Figure 1

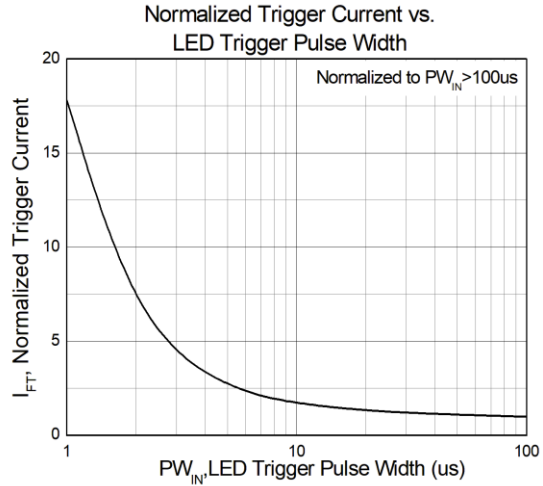

Figure 2

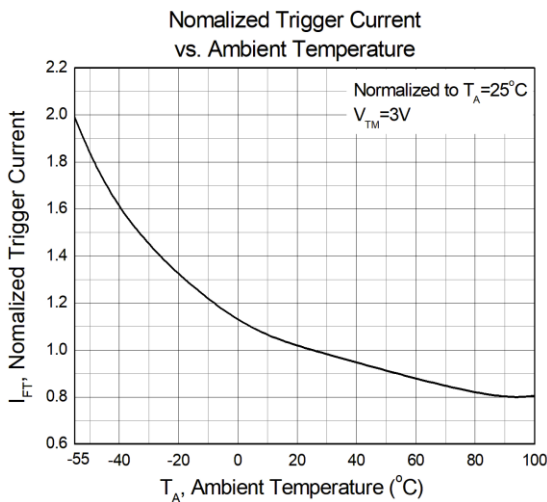

Figure 3

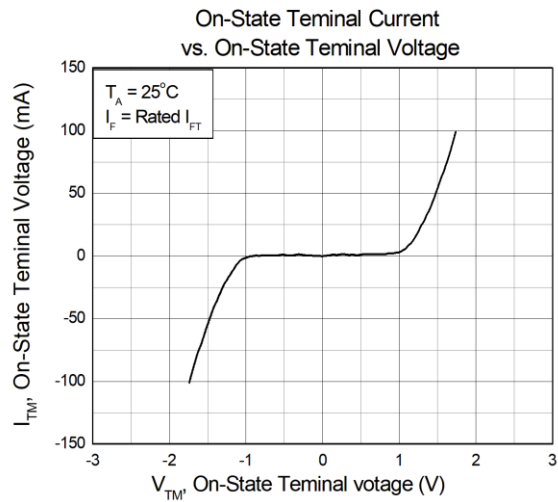

Figure 4

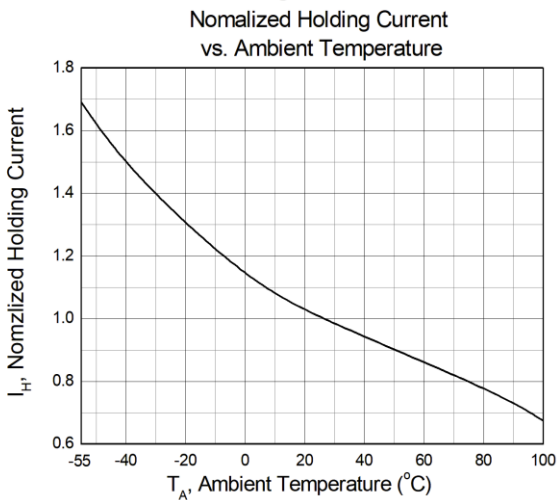

Figure 5

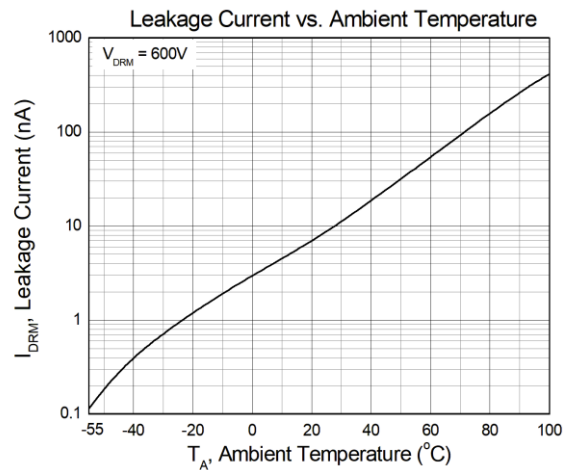

Figure 6



Typical Characteristic Curves $T_A = 25^\circ\text{C}$, unless otherwise specified (Continued)

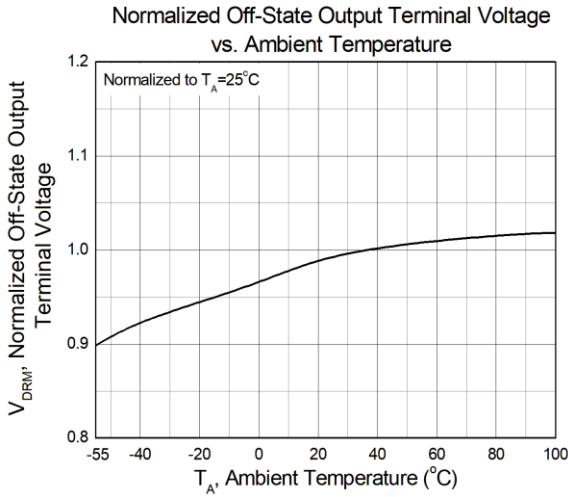

Figure 7

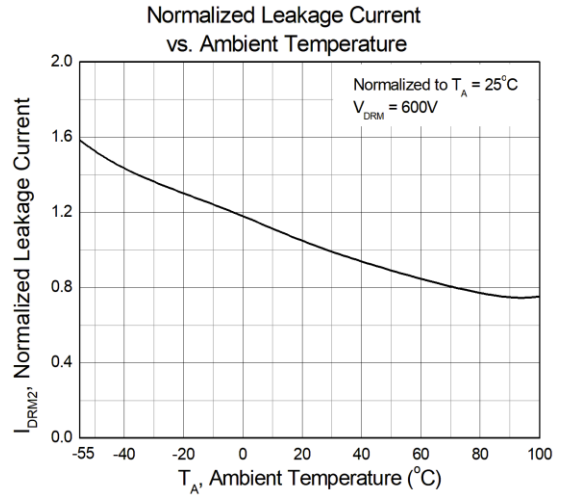

Figure 8

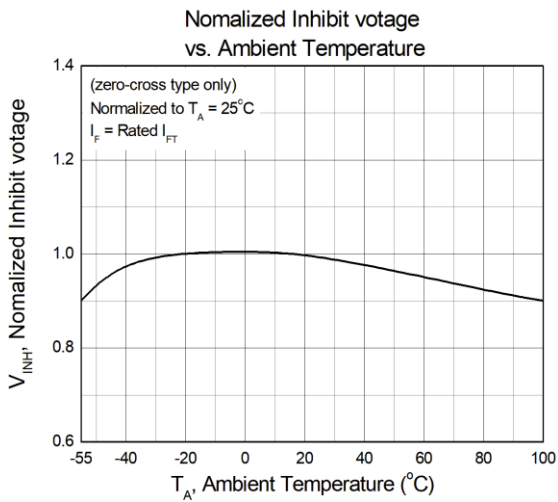
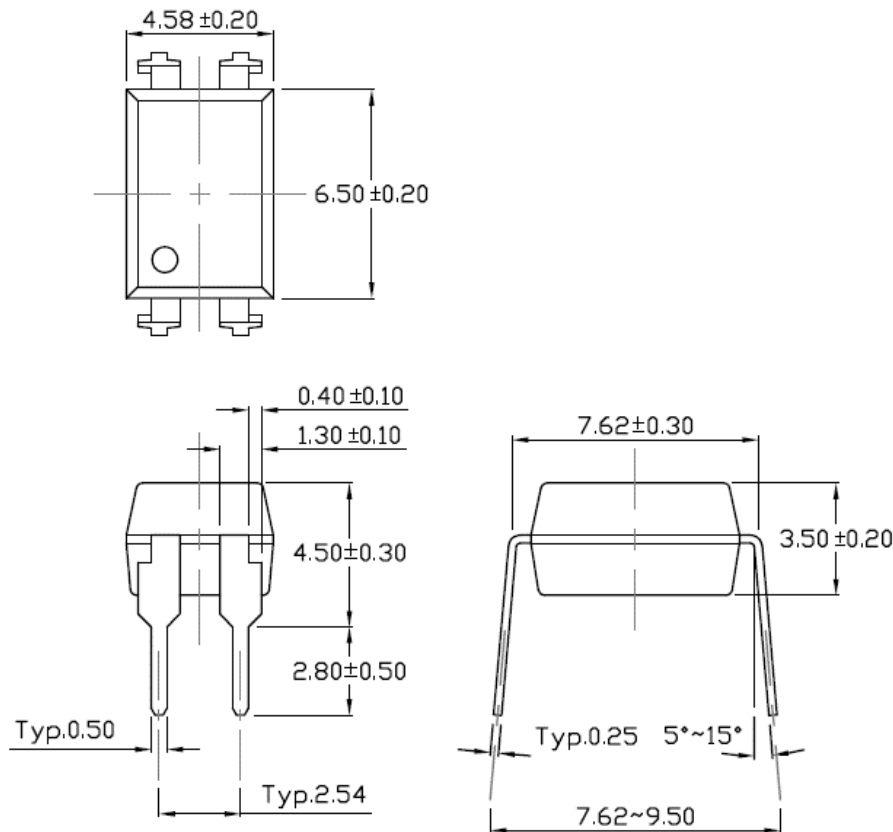

Figure 9



Package Dimension *Dimensions in mm unless otherwise stated*

Standard DIP – Through Hole



Forming Option *Dimensions in mm unless otherwise stated*

M Type

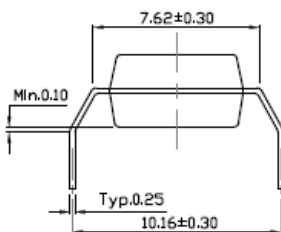

S Type

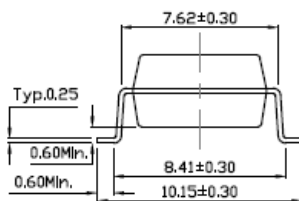

SL Type

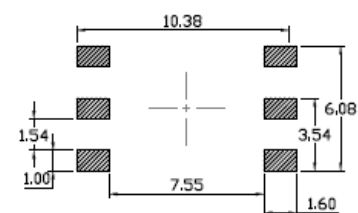
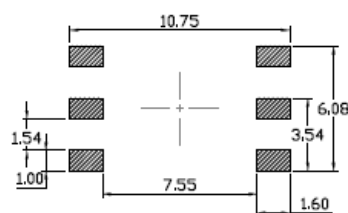
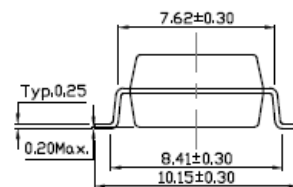



Marking Information



Note:

- CT : Denotes “CT Micro”
- 3061 : Part Number
- V : VDE Safety Mark Option (Blank or V)
- Y : One Digit Year Code
- WW : Two Digit Work Week
- K : Manufacturing Code

Ordering Information

CT306X(V)(Y)(Z)-4L-G, CT308X(V)(Y)(Z)-4L

- CT = Denotes “CT Micro”
- 306X = Part Numbers (Current Ration Option X=1, 2 or 3)
- 308X = Part Numbers (Current Ration Option X=1, 2 or 3)
- V = VDE Option (V or None)
- Y = Lead Form Option (S, SL, M or none)
- Z = Tape and Reel Option (T1 or T2)
- 4L = 4-Lead DIP Package
- G = Material Option (G: Halogen Free, None: Non-Halogen Free)

Option	Description	Quantity
None	Standard 4 Pin DIP	100 Units/Tube
M	Gullwing (400mil) Lead Forming	100 Units/Tube
S(T1)	Surface Mount Lead Forming – With Option 1 Taping	1500 Units/Reel
S(T2)	Surface Mount Lead Forming – With Option 2 Taping	1500 Units/Reel
SL(T1)	Surface Mount (Low Profile) Lead Forming– With Option 1 Taping	1500 Units/Reel
SL(T2)	Surface Mount (Low Profile) Lead Forming – With Option 2 Taping	1500 Units/Reel



www.ct-micro.com

CT3061-4L, CT3062-4L, CT3063-4L
CT3081-4L, CT3082-4L, CT3083-4L
600V/800V Zero Cross 4-Pin DMC-Isolator®
Phototriac Optocoupler

Carrier Specifications *Dimensions in mm unless otherwise stated*

Tube Option Standard DIP

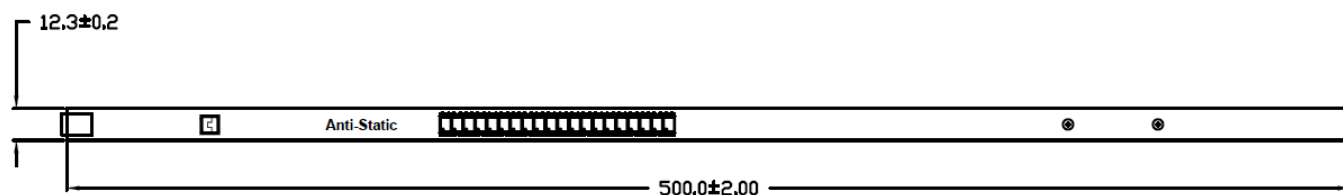

Tube Option M Type

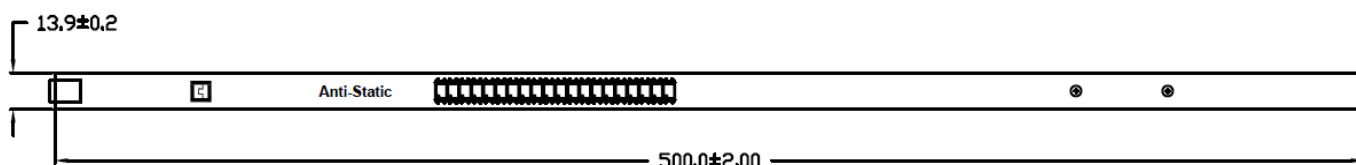

Reel Dimension *All dimensions are in mm, unless otherwise stated*

Option S(T1/T2) & SL(T1/T2)

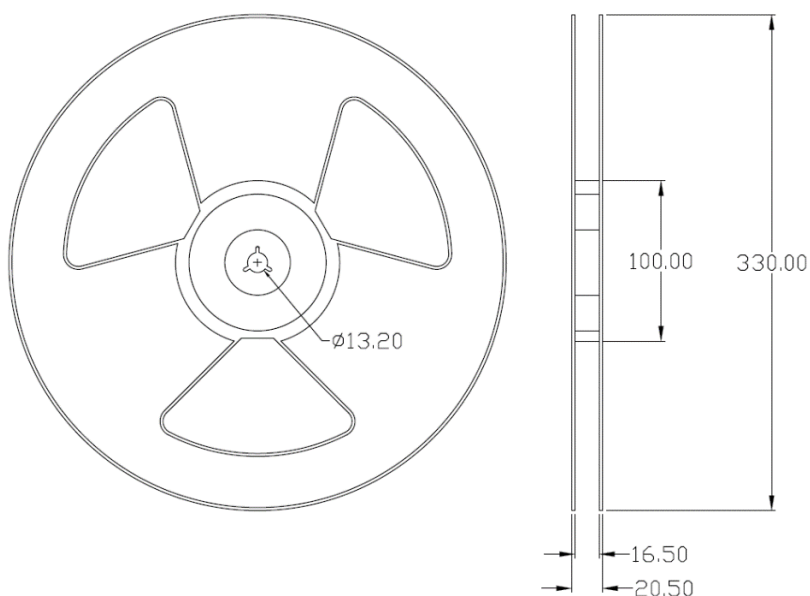



Carrier Tape Specifications *Dimensions in mm unless otherwise stated*

Option S(T1) & SL(T1)

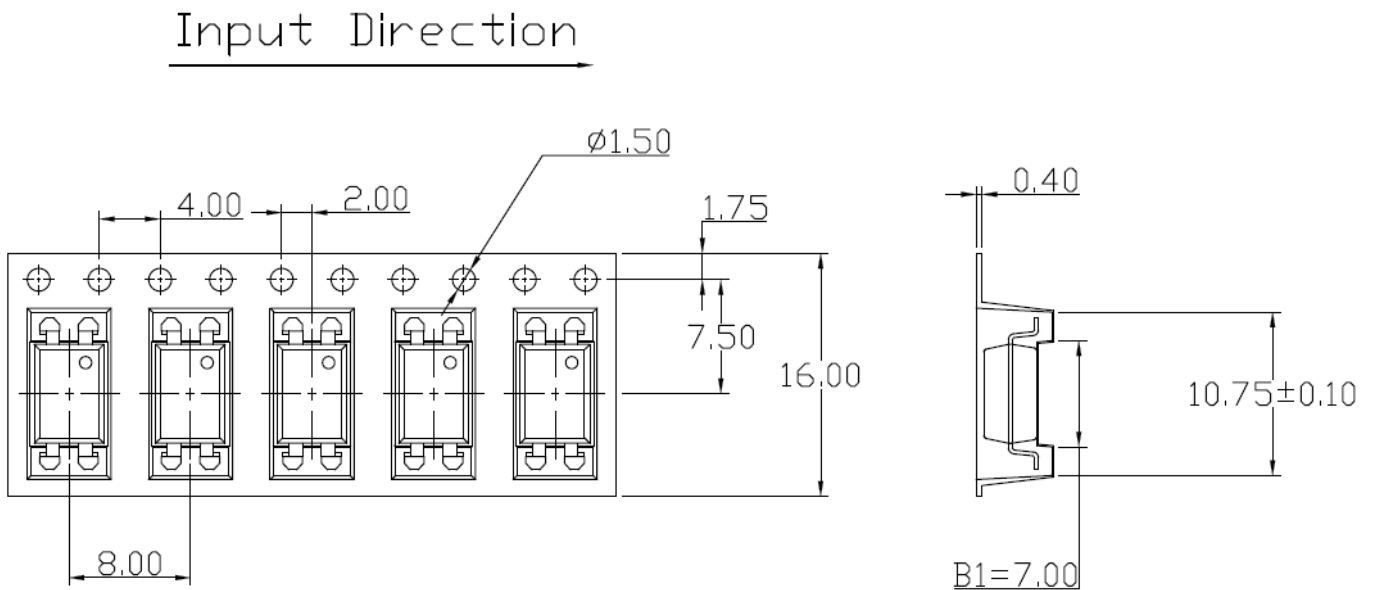

Option S(T2) & SL(T2)

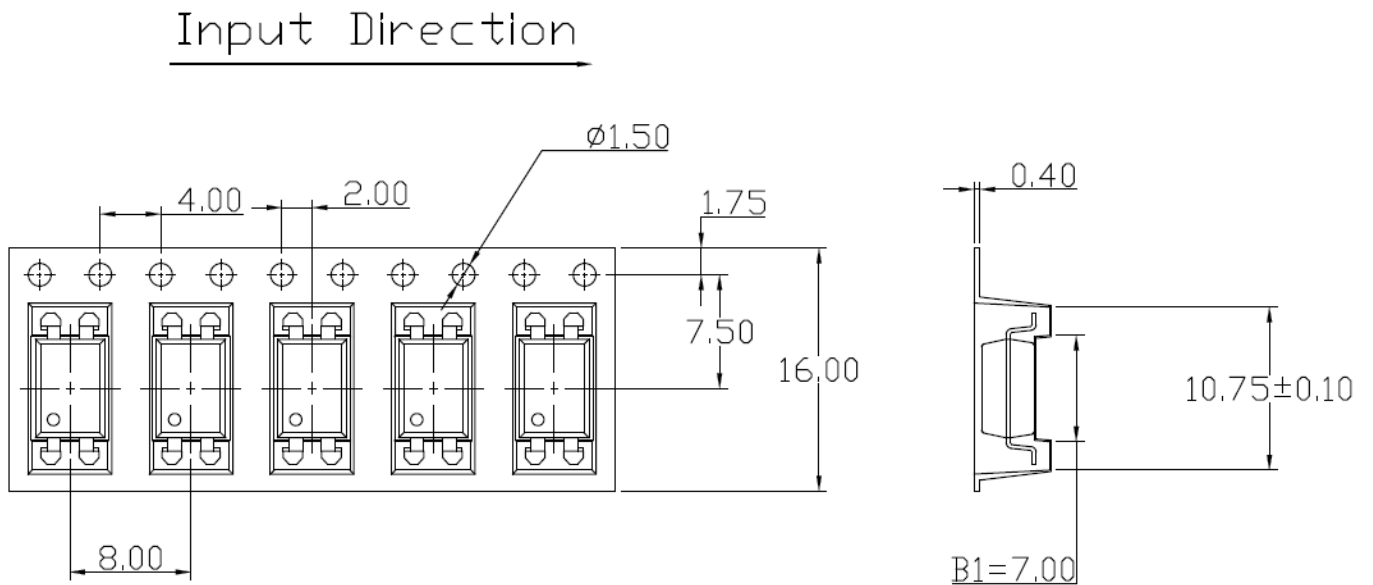



Solderability spec (Follow the JEDEC standard JESD22-B102)

Reflow Soldering: Immersed surface, other than the end of pin as cut-surface, must be covered by solder.

Solder-Bath: More than 95% of the electrode must be covered with solder.

Wave soldering (Follow the JEDEC standard JESD22-A111)

One time soldering is recommended within the condition of temperature.

Temperature: $260 \pm 0/-5^\circ\text{C}$.

Time: 10 sec.

Preheat temperature: 25 to 140°C .

Preheat time: 30 to 80 sec.

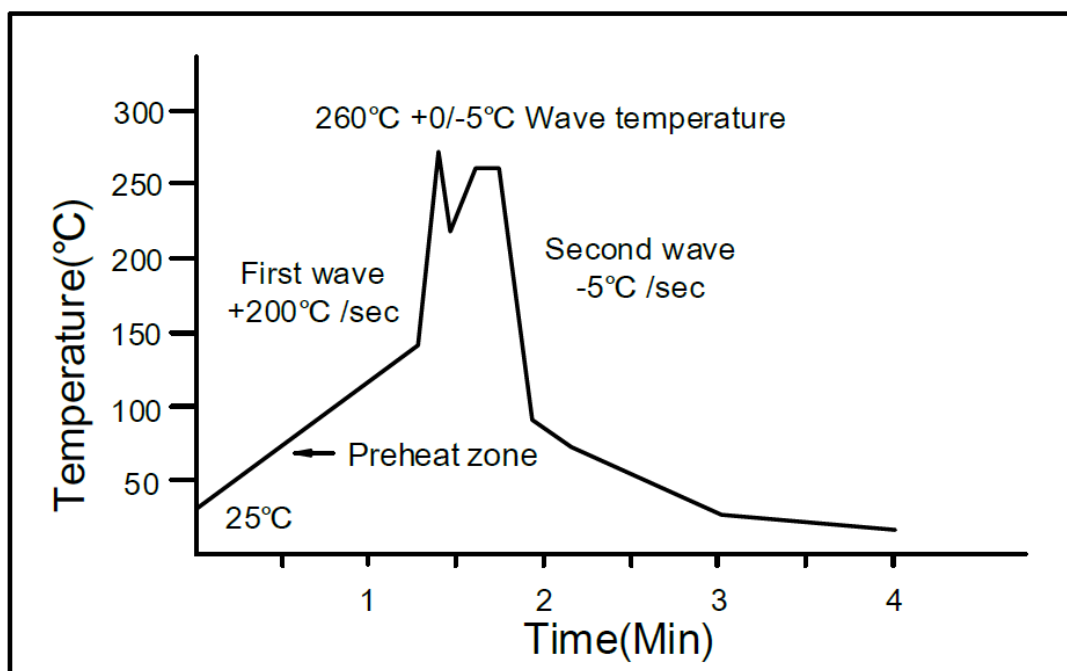

Iron soldering (Follow the standard MIL-STD 202G, Method 210F)

Allow single lead soldering in every single process.

One time soldering is recommended. Temperature: $350 \pm 10^\circ\text{C}$

Time: 5 sec max.



Reflow Profile (Follow the JEDEC standard J-STD-020)

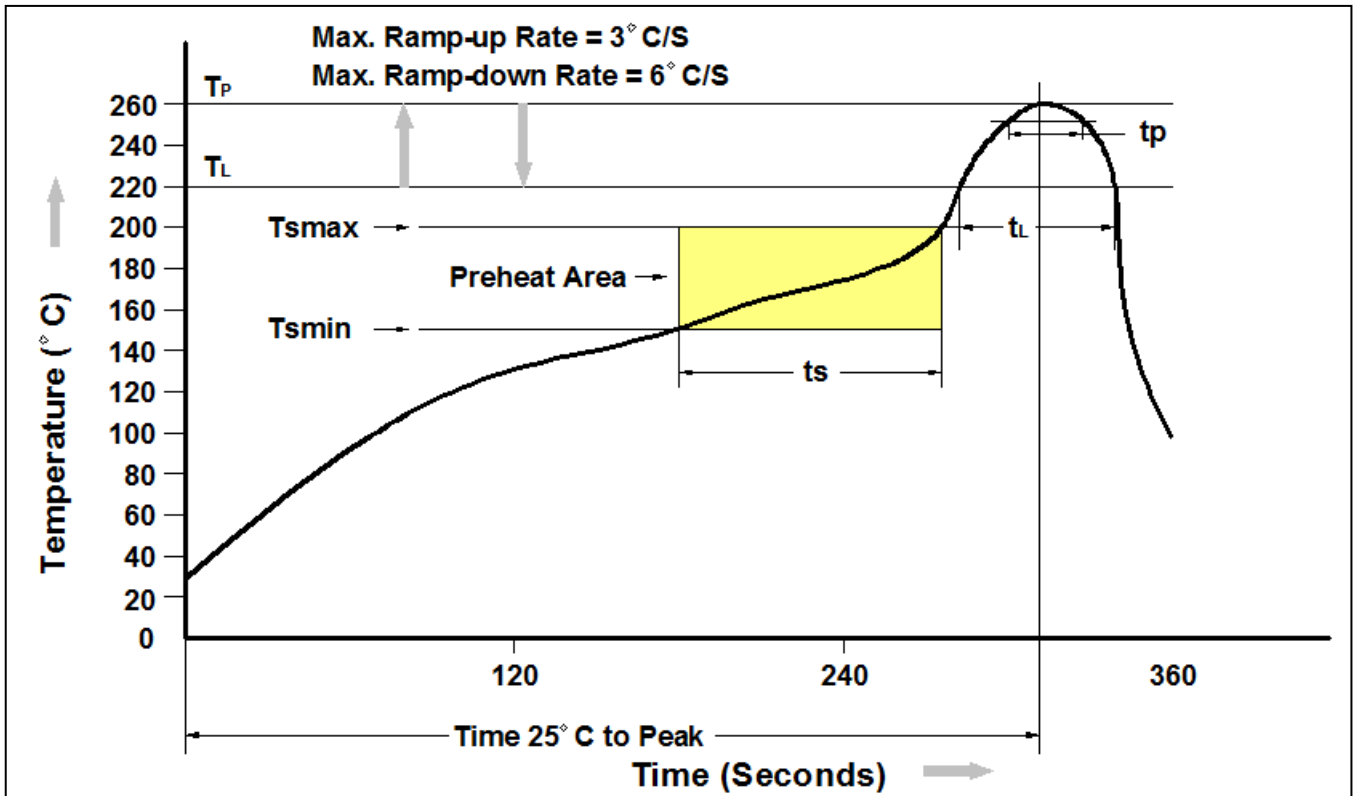

Profile Feature	Pb-Free Assembly Profile
Temperature Min. (T _{smin})	150°C
Temperature Max. (T _{smax})	200°C
Time (t _s) from (T _{smin} to T _{smax})	60-120 seconds
Ramp-up Rate (t _L to t _P)	3°C/second max.
Liquidous Temperature (T _L)	217°C
Time (t _L) Maintained Above (T _L)	60 – 150 seconds
Peak Body Package Temperature	260°C +0°C / -5°C
Time (t _P) within 5°C of 260°C	30 seconds
Ramp-down Rate (T _P to T _L)	6°C/second max
Time 25°C to Peak Temperature	8 minutes max.



DISCLAIMER

DMC-Isolator® IS A TRADEMARK OF CT MICRO INTERNATIONAL CORPORATION AND/OR ITS SUBSIDIARIES. CT MICRO OWNS THE RIGHTS TO A NUMBER OF PATENTS, TRADEMARKS, COPYRIGHTS AND OTHER INTELLECTUAL PROPERTY.

CT MICRO RESERVES THE RIGHT TO MAKE CHANGES WITHOUT FURTHER NOTICE TO ANY PRODUCTS HEREIN TO IMPROVE RELIABILITY, FUNCTION OR DESIGN. CT MICRO DOES NOT ASSUME ANY LIABILITY ARISING OUT OF THE APPLICATION OR USE OF ANY PRODUCT OR CIRCUIT DESCRIBED HEREIN; NEITHER DOES IT CONVEY ANY LICENSE UNDER ITS PATENT RIGHTS, NOR THE RIGHTS OF OTHERS.

DISCOLORATION MIGHT OCCUR ON THE PACKAGE SURFACE AFTER SOLDERING, REFLOW OR LONG TERM USE. THIS DOES NOT IMPACT THE PRODUCT PERFORMANCE NOR THE PRODUCT RELIABILITY.

CT MICRO ARE NOT AUTHORIZED FOR USE AS CRITICAL COMPONENTS IN LIFE SUPPORT DEVICES OR SYSTEMS WITHOUT EXPRESS WRITTEN APPROVAL OF CT MICRO INTERNATIONAL CORPORATION.

- 1. Life support devices or systems are devices or systems which, (a) are intended for surgical implant into the body, or (b) support or sustain life, or (c) whose failure to perform when properly used in accordance with instruction for use provided in the labelling, can be reasonably expected to result in significant injury to the user.*
- 2. A critical component is any component of a life support device or system whose failure to perform can be reasonably expected to cause the failure of the life support device or system, or to affect its safety or effectiveness.*