

MITSUBISHI INSULATED GATE BIPOLAR TRANSISTOR

CT60AM-18B

RESONANT INVERTER USE

CT60AM-18B

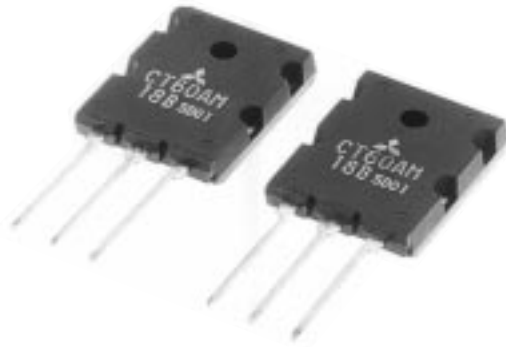

- VCES 900V
- IC 60A
- Integrated Fast Recovery Diode

OUTLINE DRAWING

Dimensions in mm

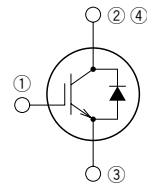
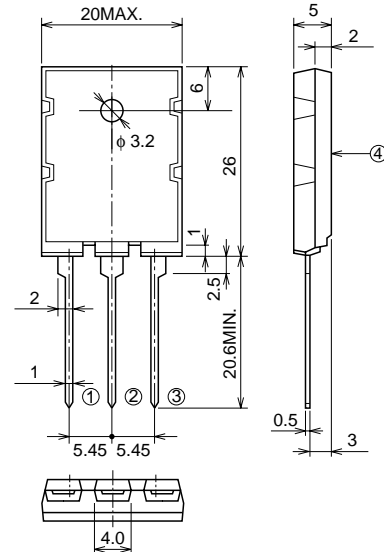

- ① GATE
- ② COLLECTOR
- ③ EMITTER
- ④ COLLECTOR

TO-3PL

APPLICATION

Microwave ovens, electromagnetic cooking devices, rice-cookers, voltage-resonant inverter circuit electric appliances.

MAXIMUM RATINGS (Tc = 25°C)

Symbol	Parameter	Conditions	Ratings	Unit
V _{CE} S	Collector-emitter voltage	V _{GE} = 0V	900	V
V _{GES}	Gate-emitter voltage	V _{CE} = 0V	±20	V
V _{GEM}	Peak gate-emitter voltage	V _{CE} = 0V	±30	V
I _C	Collector current		60	A
I _{CM}	Collector current (Pulsed)		120	A
I _E	Emitter current		40	A
P _C	Maximum power dissipation	T _C = 25°C	200	W
T _j	Junction temperature		-40 ~ +150	°C
T _{stg}	Storage temperature		-40 ~ +150	°C

ELECTRICAL CHARACTERISTICS (T_j = 25°C unless otherwise noted)

Symbol	Parameter	Test conditions	Limits			Unit
			Min.	Typ.	Max.	
V (BR) CES	Collector-emitter breakdown voltage	I _C = 1mA, V _{GE} = 0V	900	—	—	V
I _{CES}	Collector-emitter leakage current	V _{CE} = 900V, V _{GE} = 0V	—	—	1	mA
I _{GES}	Gate-emitter leakage current	V _{GE} = ±20V, V _{CE} = 0V	—	—	±0.5	μA
V _{GE(th)}	Gate-emitter threshold voltage	V _{CE} = 10V, I _C = 6mA	2.0	4.0	6.0	V
V _{CE(sat)}	Collector-emitter saturation voltage	I _C = 60A, V _{CE} = 15V	—	2.0	2.7	V
C _{ies}	Input capacitance	V _{CE} = 25V, V _{GE} = 0V, f = 1MHz	—	5000	—	pF
C _{oes}	Output capacitance		—	125	—	pF
C _{res}	Reverse transfer capacitance		—	85	—	pF
t _{d (on)}	Turn-on delay time	I _C = 60A, Resistance load, V _{CC} = 300V, V _{GE} = 15V, R _G = 10Ω	—	0.05	—	μs
t _r	Rise time		—	0.12	—	μs
t _{d (off)}	Turn-off delay time		—	0.30	—	μs
t _f	Fall time		—	0.25	—	μs
E _{tail}	Tail loss		I _{CP} = 60A, T _j = 125°C, dv/dt = 200V/μs	—	0.6	1.0
I _{Ctail}	Collector tail current	I _E = 60A, V _{GE} = 0V	—	6	12	A
V _{EC}	Emitter-collector voltage	I _E = 60A, V _{GE} = 0V	—	—	3	V
T _{rr}	Reverse recovery time	I _E = 60A, di/dt = 20A/μs	—	0.5	2	μs
R _{th (j-c)}	Thermal resistance (IGBT part)	Junction to case	—	—	0.63	°C/W
R _{th (j-c)}	Thermal resistance	Junction to case	—	—	4.0	°C/W

PERFORMANCE CURVES

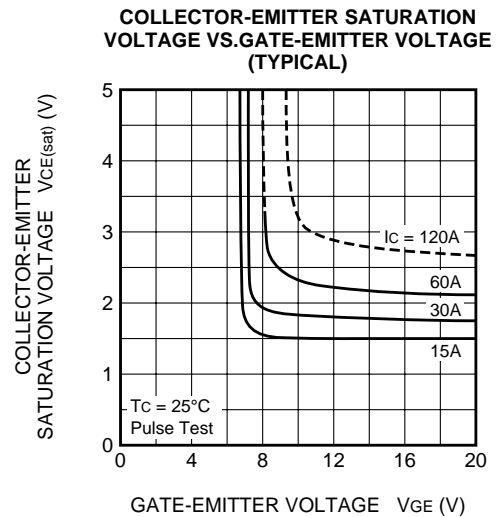
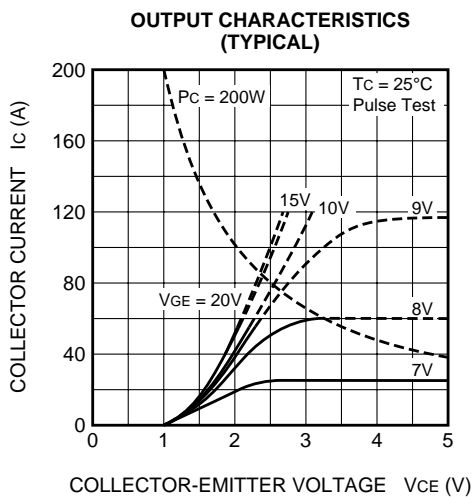

COLLECTOR CURRENT VS. GATE-EMITTER VOLTAGE (TYPICAL)

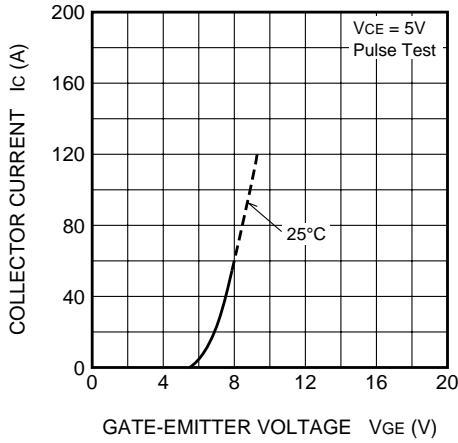

CAPACITANCE VS. COLLECTOR-EMITTER VOLTAGE (TYPICAL)

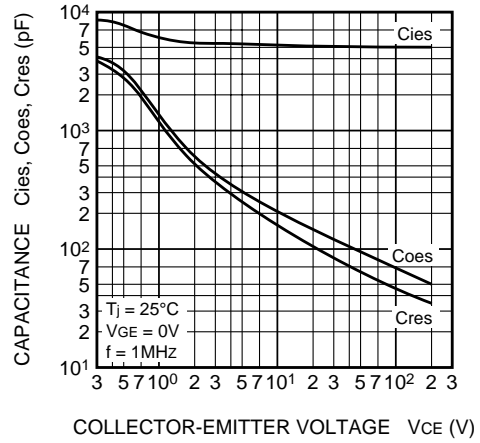

SWITCHING CHARACTERISTICS (TYPICAL)

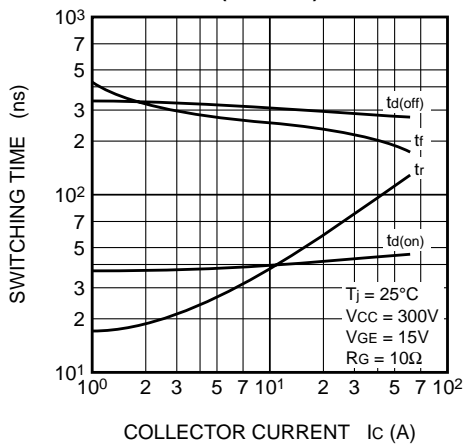

SWITCHING TIME VS. GATE RESISTANCE (TYPICAL)

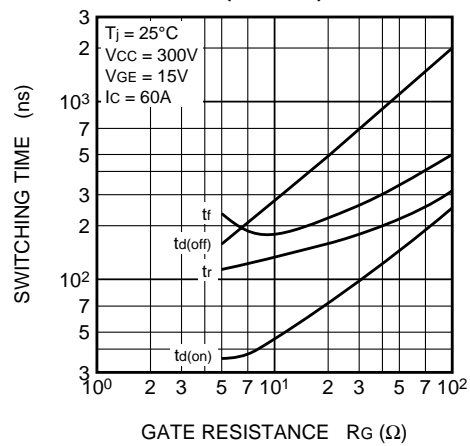

GATE-EMITTER VOLTAGE VS. GATE CHARGE CHARACTERISTIC (TYPICAL)

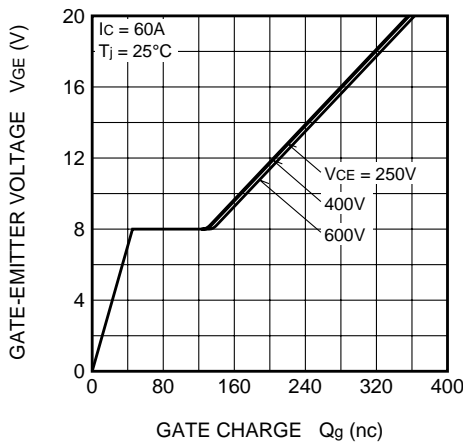

TRANSFER CHARACTERISTICS (TYPICAL)

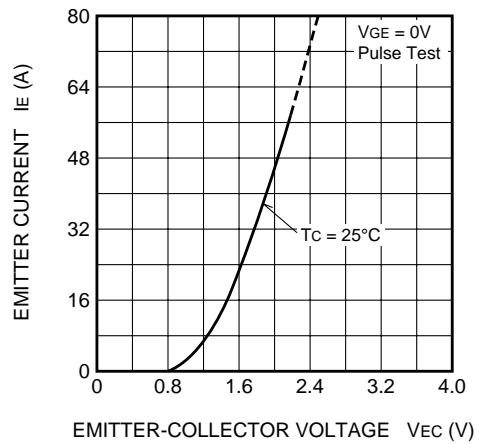

CT60AM-18B

RESONANT INVERTER USE

