



N-Channel Enhancement MOSFET

Features

- Drain-Source Breakdown Voltage V_{DS} 40 V
- Drain-Source On-Resistance
 $R_{DS(ON)}$ 32m Ω , at V_{GS} = 10V, I_D = 4.0A
 $R_{DS(ON)}$ 50m Ω , at V_{GS} = 4.5V, I_D = 3.0A
- Continuous Drain Current at $T_A=25^\circ\text{C}$ I_D =4.0A
- Advanced high cell density Trench Technology
- RoHS Compliance & Halogen Free

Description

The CTL0404NS-R3 is the N-Channel logic enhancement mode power field effect transistors are produced using high cell density, DMOS trench technology. This high density process is especially tailored to minimize on-state resistance.

Applications

- Power Management
- Portable Equipment
- DC/DC Converter
- Load Switch

Package Outline

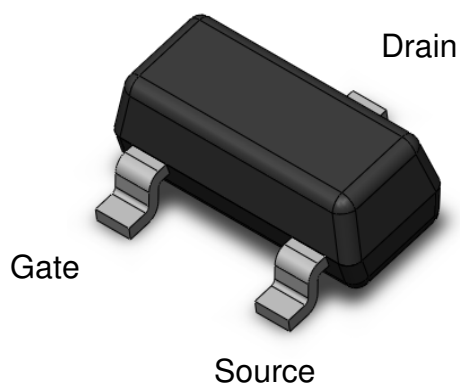

Schematic

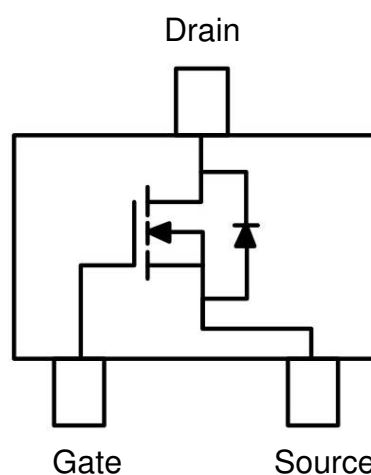



CTL0404NS-R3

N-Channel Enhancement MOSFET

Absolute Maximum Rating at 25°C

Symbol	Parameters	Test Conditions	Min	Notes
V _{DS}	Drain-Source Voltage	40	V	
V _{GS}	Gate-Source Voltage	±20	V	
I _D	Continuous Drain Current @T _A =25°C	4	A	1
I _{DM}	Pulsed Drain Current	16	A	1
P _D	Total Power Dissipation @T _A =25°C	1.4	W	2
T _{STG}	Storage Temperature Range	-55 to 150	°C	
T _J	Operating Junction Temperature Range	-55 to 150	°C	

Thermal Characteristics

Symbol	Parameters	Test Conditions	Min	Typ	Max	Units	Notes
R _{θJA4}	Thermal Resistance Junction-Ambient (t=10s)		--	120	--	°C /W	1,4



N-Channel Enhancement MOSFET

Electrical Characteristics $T_A = 25^\circ\text{C}$ (unless otherwise specified)

Static Characteristics

Symbol	Parameters	Test Conditions	Min	Typ	Max	Units	Notes
$B_{V_{DS}}$	Drain-Source Breakdown Voltage	$V_{GS} = 0V, I_D = 250\mu A$	40	-	-	V	
I_{DSS}	Drain-Source Leakage Current	$V_{DS} = 40V, V_{GS} = 0V$	-	-	1	μA	
I_{GSS}	Gate-Source Leakage Current	$V_{GS} = \pm 20V, V_{DS} = 0V$	-	-	± 100	nA	

On Characteristics

Symbol	Parameters	Test Conditions	Min	Typ	Max	Units	Notes
$R_{DS(ON)}$	Drain-Source On-Resistance	$V_{GS} = 10V, I_D = 4.0A$	-	32	40	$m\Omega$	3
		$V_{GS} = 4.5V, I_D = 3.0A$	-	50	65	$m\Omega$	
$V_{GS(th)}$	Gate-Source Threshold Voltage	$V_{GS} = V_{DS}, I_D = 250\mu A$	1.0	---	3.0	V	3

Dynamic Characteristics

Symbol	Parameters	Test Conditions	Min	Typ	Max	Units	Notes
C_{ISS}	Input Capacitance	$V_{GS} = 0V,$ $V_{DS} = 20V$ $f = 1MHz$	-	560	-	pF	
C_{OSS}	Output Capacitance		-	70	-		
C_{RSS}	Reverse Transfer Capacitance		-	22	-		

Switching Characteristics

Symbol	Parameters	Test Conditions	Min	Typ	Max	Units	Notes
$T_{D(ON)}$	Turn-On Delay Time	$V_{DS} = 20V,$ $V_{GS} = 10V,$ $R_G = 1\Omega,$ $R_L = 20\Omega,$	-	12	-	ns	
T_R	Rise Time		-	12	-		
$T_{D(OFF)}$	Turn-Off Delay Time		-	37	-		
T_F	Fall Time		-	4	-		
Q_G	Total Gate Charge	$V_{DS} = 20V,$ $V_{GS} = 4.5V,$ $I_D = 4.0A$	-	8.2	-	nC	
Q_{GS}	Gate-Source Charge		-	3.6	-		
Q_{GD}	Gate-Drain Charge		-	3.9	-		



Drain-Source Diode Characteristics

Symbol	Parameters	Test Conditions	Min	Typ	Max	Units	Notes
V _{SD}	Body Diode Forward Voltage	V _{GS} = 0V, I _D = 1A	-	0.8	1.2	V	
I _{SD}	Body Diode Continuous Current		-	-	1	A	1

Note:

- 1. The power dissipation is limited by 150°C junction temperature.
- 2. Device mounted on a glass-epoxy board

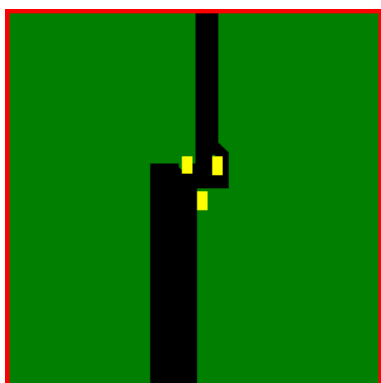

FR-4
25.4 × 25.4 mm .
2 Oz Copper

Actual Size

- 3. The data tested by pulsed , pulse width $\leq 300\mu s$, duty cycle $\leq 2\%$
- 4. Thermal Resistance follow JESD51-3.



Typical Characteristic Curves

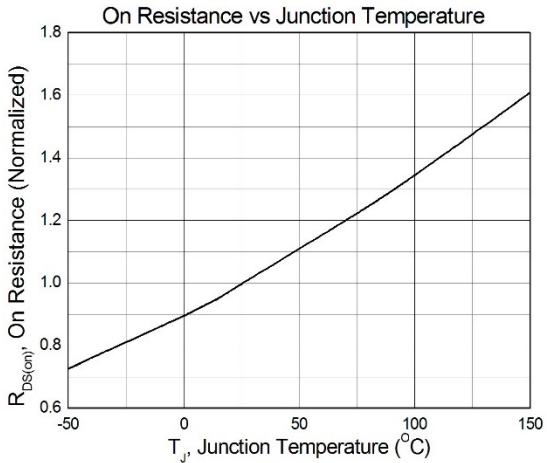

Figure 1

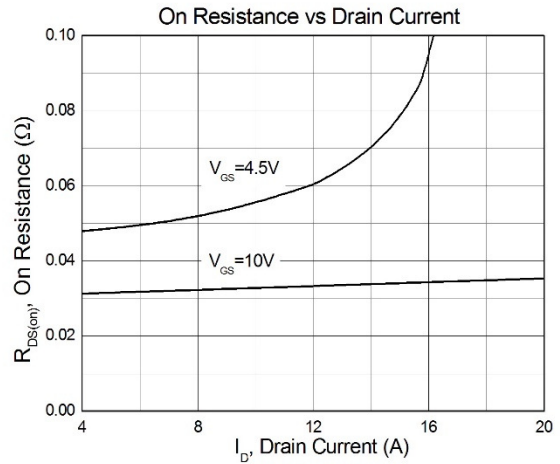

Figure 2

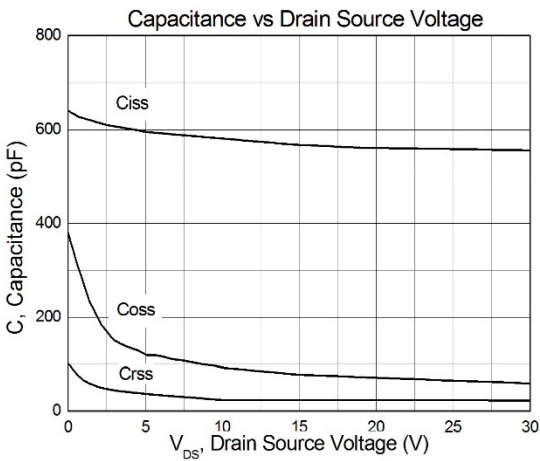

Figure 3

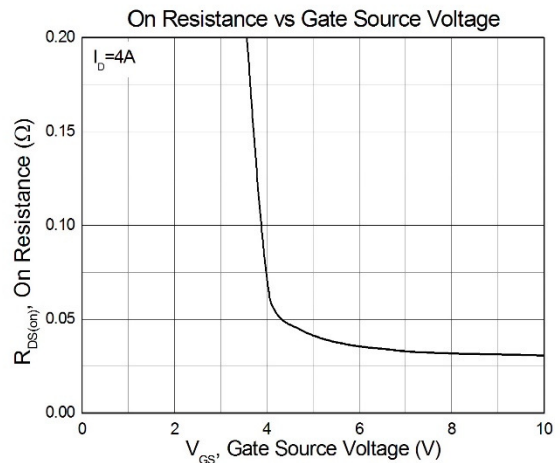

Figure 4

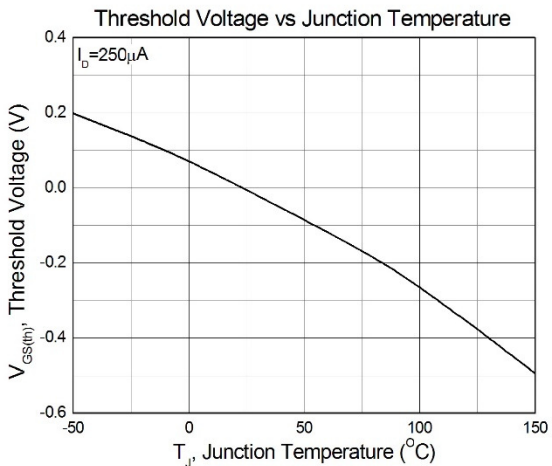

Figure 5

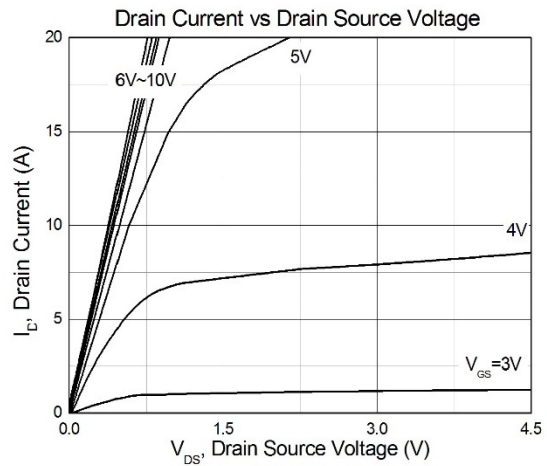
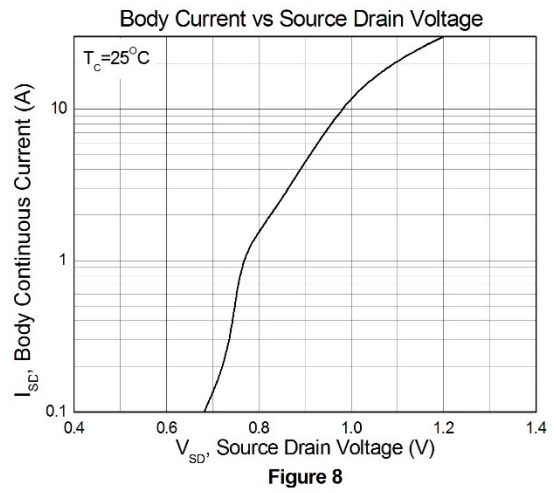
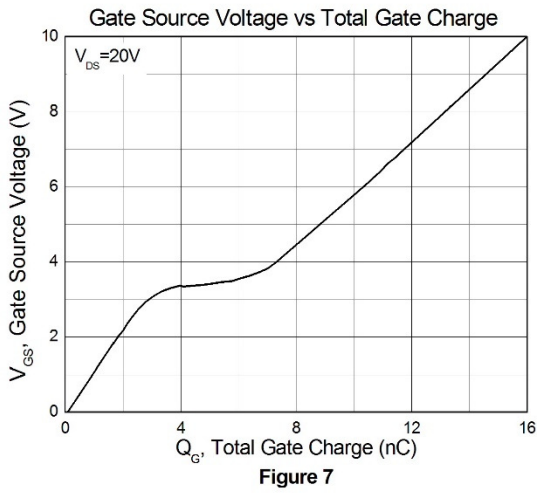

Figure 6





Test Circuits & Waveforms

Figure 9: Gate Charge Test Circuit

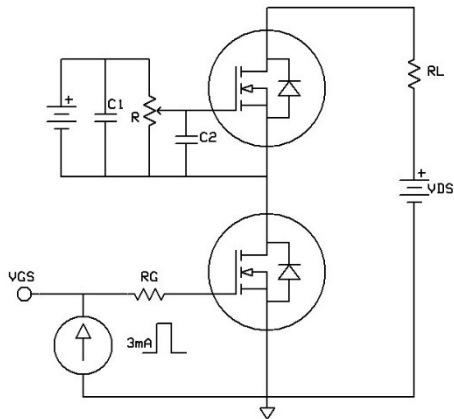

Figure 10: Gate Charge Waveform

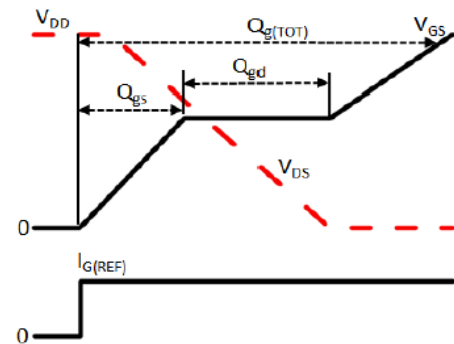

Figure 11: Switching Time Test Circuit

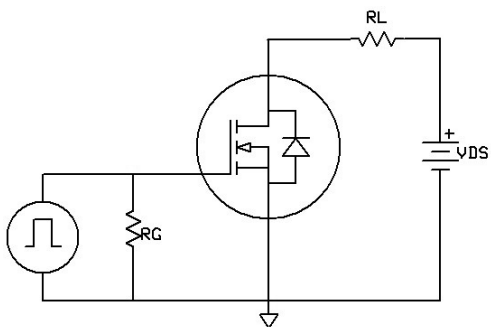
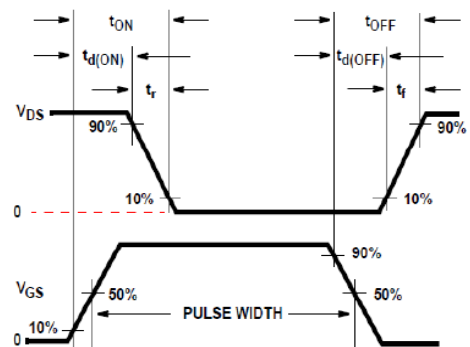
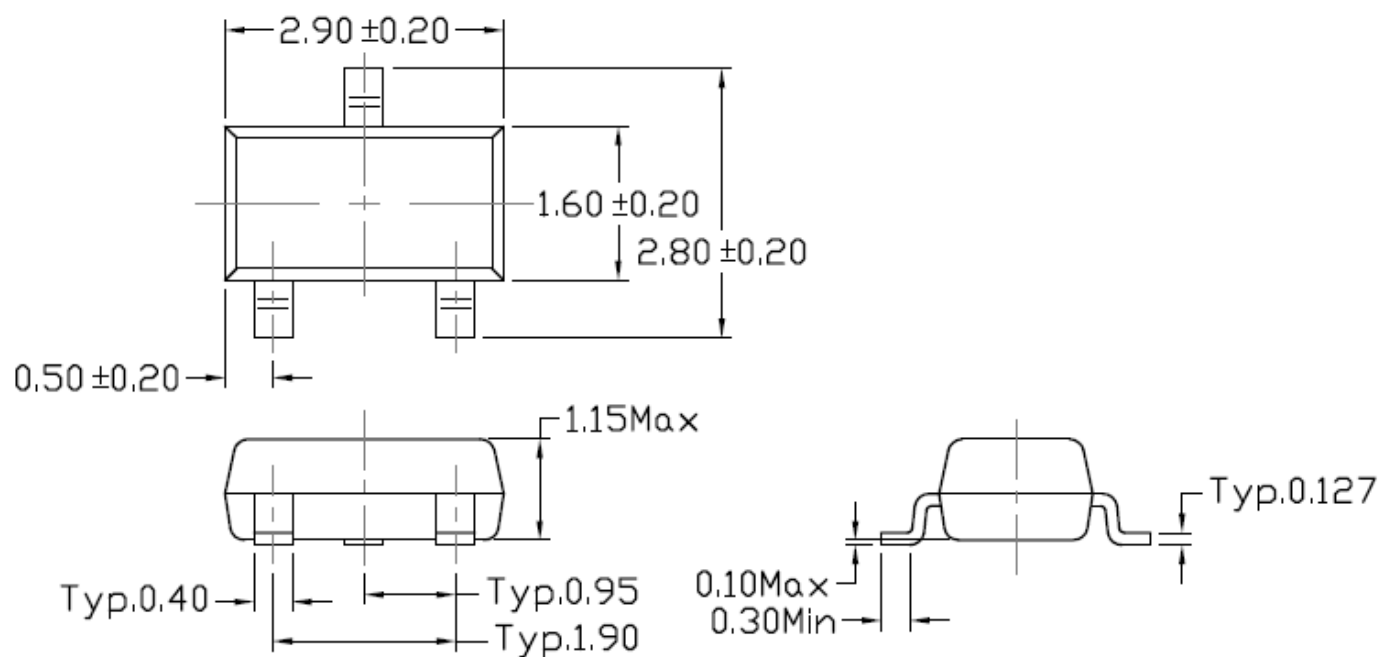

Figure 12: Switching Time Waveform





Package Dimension (SC-59)



Note: Dimensions in mm

Recommended pad layout for surface mount leadform

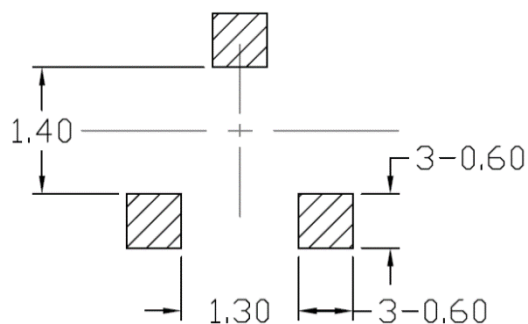

Note: Dimensions in mm



CTL0404NS-R3

N-Channel Enhancement MOSFET

Marking Information

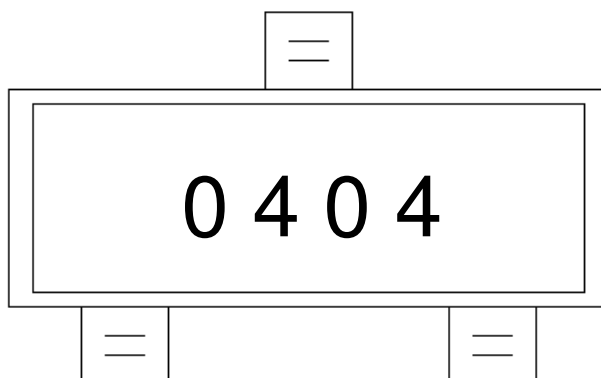

0404: Device Number

Ordering Information

Part Number	Description	Quantity
CTL0404NS-R3	SC-59 Reel	3000 pcs



Reflow Profile

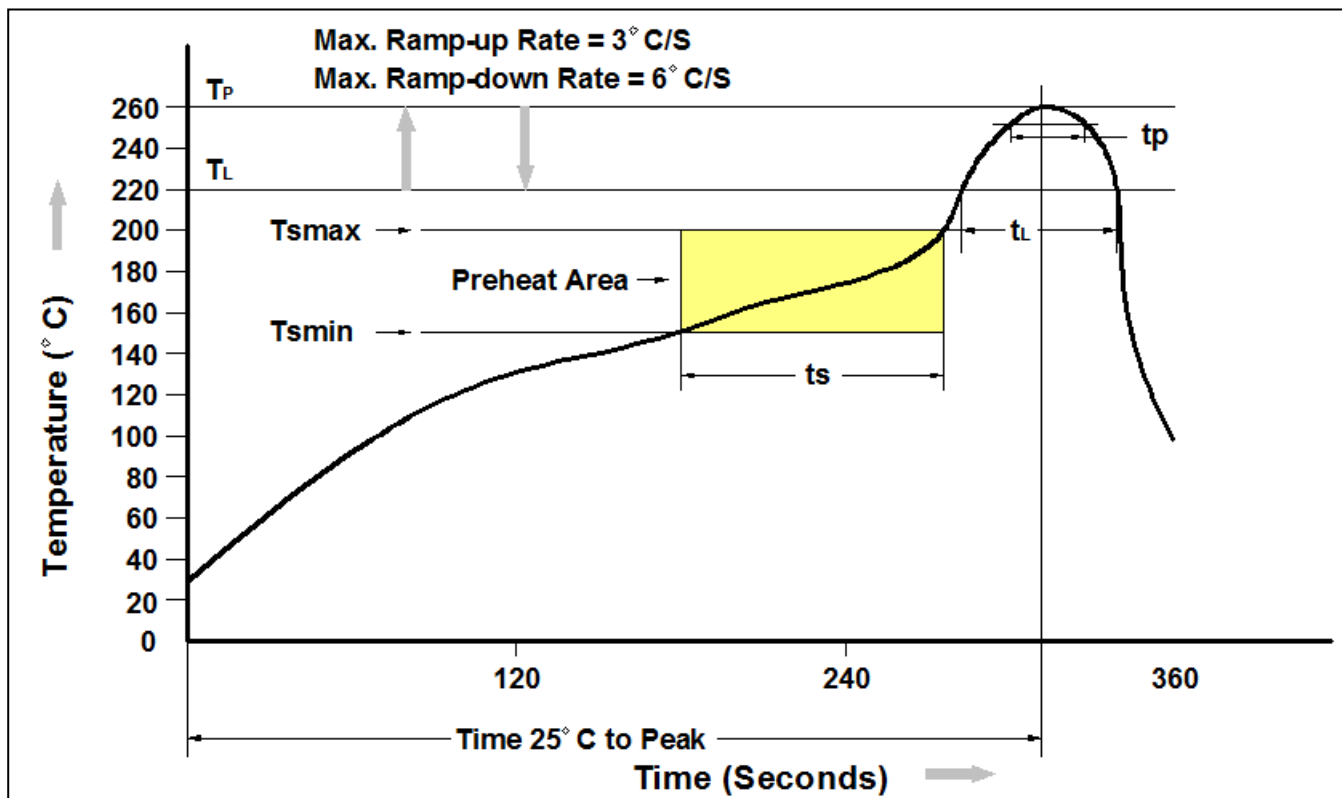

Profile Feature	Pb-Free Assembly Profile
Temperature Min. (T _{smin})	150 °C
Temperature Max. (T _{smax})	200 °C
Time (t _s) from (T _{smin} to T _{smax})	60-120 seconds
Ramp-up Rate (t _L to t _P)	3 °C/second max.
Liquidous Temperature (T _L)	217 °C
Time (t _L) Maintained Above (T _L)	60 – 150 seconds
Peak Body Package Temperature	260 °C +0 °C / -5 °C
Time (t _P) within 5 °C of 260 °C	30 seconds
Ramp-down Rate (T _P to T _L)	6 °C/second max
Time 25 °C to Peak Temperature	8 minutes max.



DISCLAIMER

CT MICRO RESERVES THE RIGHT TO MAKE CHANGES WITHOUT FURTHER NOTICE TO ANY PRODUCTS HEREIN TO IMPROVE RELIABILITY, FUNCTION OR DESIGN. CT MICRO DOES NOT ASSUME ANY LIABILITY ARISING OUT OF THE APPLICATION OR USE OF ANY PRODUCT OR CIRCUIT DESCRIBED HEREIN; NEITHER DOES IT CONVEY ANY LICENSE UNDER ITS PATENT RIGHTS, NOR THE RIGHTS OF OTHERS.

CT MICRO ARE NOT AUTHORIZED FOR USE AS CRITICAL COMPONENTS IN LIFE SUPPORT DEVICES OR SYSTEMS WITHOUT EXPRESS WRITTEN APPROVAL OF CT MICRO INTERNATIONAL CORPORATION.

- 1. Life support devices or systems are devices or systems which, (a) are intended for surgical implant into the body, or (b) support or sustain life, or (c) whose failure to perform when properly used in accordance with instruction for use provided in the labelling, can be reasonably expected to result in significant injury to the user.*
- 2. A critical component is any component of a life support device or system whose failure to perform can be reasonably expected to cause the failure of the life support device or system, or to affect its safety or effectiveness.*