

Toroidal Inductors

Medium Current

CTP4553

CTP4553 is a medium current inductor with the following data and features:

- **Core type:** 0.68" o.d., Moly-Permalloy Powder, perm 60.
 - **Power rating:** 0.86 watts for temp. rise 50°C.
 - **Typical applications:** Switching Inductors in Switch Mode Power Supplies.
- Four mounting styles are offered:**
- 1 Flying leads (1.00"), for vertical or horizontal mounting.
 - 2 4-pin header, for vertical mounting.
 - 3 Threaded center hole, flying leads (2.00").
 - 4 2-pin header, for vertical mounting.



MECHANICAL

Style 1

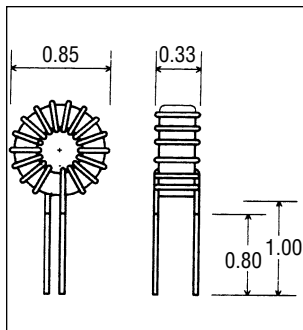

Style 2

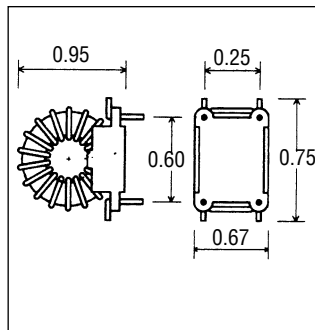

Style 3

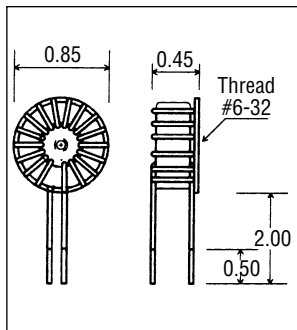

Style 4

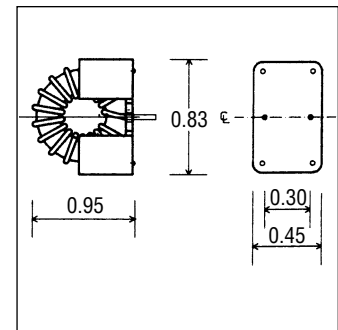

ELECTRICAL SPECIFICATION

Ordering Information: Substitute the style number for the asterisk (*). Example: CTP4553, Style 1, 56uH. Order: CTP4553 - 116

Part No. CTP4553 -	Ind. (uH)	DCR Ohms	Rated Current Amp. RMS	I (amp.) @ Lsat. 10%	I (amp.) @ Lsat. 25%	I (amp.) @ Lsat. 50%	Part No. CTP4553 -	Ind. (uH)	DCR Ohms	Rated Current Amp. RMS	I (amp.) @ Lsat. 10%	I (amp.) @ Lsat. 25%	I (amp.) @ Lsat. 50%
* 01	3.3	0.006	11.7	13.5	22.6	37.6	* 17	68	0.027	5.6	3.0	5.0	8.3
* 02	3.9	0.007	11.2	12.5	20.8	34.6	* 18	82	0.030	5.4	2.7	4.5	7.5
* 03	4.7	0.007	10.7	11.3	18.9	31.5	* 19	100	0.033	5.1	2.5	4.1	6.8
* 04	5.6	0.008	10.3	10.4	17.3	28.9	* 20	120	0.046	4.3	2.2	3.7	6.2
* 05	6.8	0.009	9.8	9.4	15.7	26.2	* 21	150	0.064	3.7	2.0	3.3	5.6
* 06	8.2	0.010	9.4	8.6	14.3	23.9	* 22	180	0.071	3.5	1.8	3.1	5.1
* 07	10	0.011	9.0	7.8	13.0	21.6	* 23	220	0.098	3.0	1.7	2.8	4.6
* 08	12	0.012	8.6	7.1	11.8	19.7	* 24	270	0.137	2.5	1.5	2.5	4.2
* 09	15	0.013	8.1	6.4	10.6	17.6	* 25	330	0.151	2.4	1.4	2.3	3.8
* 10	18	0.014	7.8	5.8	9.7	16.1	* 26	390	0.164	2.3	1.2	2.1	3.5
* 11	22	0.016	7.4	5.2	8.7	14.6	* 27	470	0.180	2.2	1.1	1.9	3.2
* 12	27	0.017	7.0	4.7	7.9	13.1	* 28	560	0.248	1.9	1.0	1.7	2.9
* 13	33	0.019	6.7	4.3	7.1	11.9							
* 14	39	0.021	6.4	3.9	6.6	10.9							
* 15	47	0.023	6.1	3.6	6.0	10.0							
* 16	56	0.025	5.9	3.3	5.5	9.1							

CTP4553