

Balanced Transformer-less DUAL Amplifier for Audio Use

**Description**

The CX20172 is a bipolar IC designed as a BTL (balanced transformer-less) amplifier or a DUAL amplifier which can drive an 8Ω load with one dry cell (1.5 V).

**Features**

- Operates with one dry cell (operable if Vcc is reduced down to 0.9 V)
- Low power consumption (standard current without signals; 5 mA, 8Ω load, BTL, Vcc=1.25V)
- Large output (BTL: 80 mW/8 Ω, EIAJ; DUAL: 21 mW/CH, 8 Ω load, EIAJ; Vcc = 1.5 V for both BTL and DUAL)
- The mode of either BTL amplifier or DUAL amplifier, as well as their gain setting, is selected by combining the IC with external components.
- Muting and power ON/OFF functions incorporated.

**Structure**

Bipolar silicon monolithic IC

**Absolute Maximum Ratings (Ta = 25°C)**

|                               |      |             |    |
|-------------------------------|------|-------------|----|
| • Supply voltage              | Vcc  | 4.5         | V  |
| • Operating temperature       | Topr | -20 to +75  | °C |
| • Storage temperature         | Tstg | -55 to +150 | °C |
| • Allowable power dissipation | Pd   | 560         | mW |

**Recommended Operating Conditions**

|                  |     |            |   |
|------------------|-----|------------|---|
| • Supply voltage | Vcc | 0.9 to 2.2 | V |
|------------------|-----|------------|---|

**Package Outline**

Unit: mm

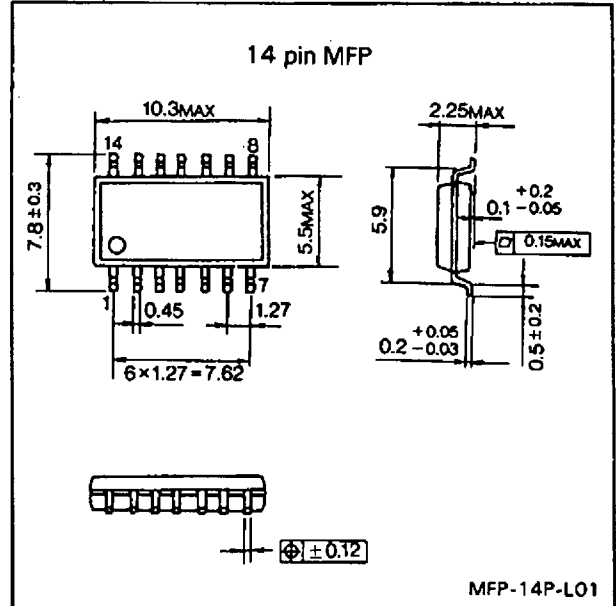

**Block Diagram**

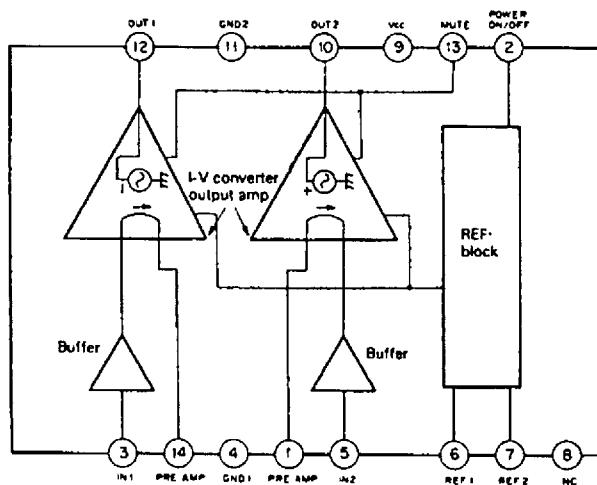

## Pin Description

(Ta = 25°C, Supply voltage: 1.25 V)

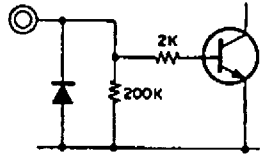
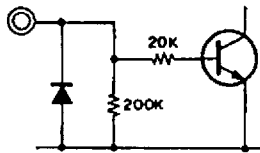
| No. | Symbol        | Description  | Standard pin voltage (V)   |
|-----|---------------|--|----------------------------|
| 1   | Pre Amp out 2 | Pin to be connected with a load resistor in the preceding-stage buffer amplifier of CH2. See the Electrical Test Circuit application circuit of BTL mode, and DUAL mode.   | 0.7                        |
| 2   | Power ON/OFF  | ON/OFF switching pin for the whole of the IC.<br>H: (power supply) IC ON<br>L: (ground) IC OFF<br>                                       | —                          |
|     |               | (standard internal equivalent circuit)   |                            |
| 3   | IN1           | Input pin for CH1. This pin is connected to the ground via a coupling capacitor, the same one as used for the input pin, when the pin is not used as an input pin in the BTL mode. <u>Standard input resistance: 10 kΩ</u> | —                          |
| 4   | GND1          | Grounding mainly for the preceding stage   | —                          |
| 5   | IN2           | Input pin for CH2. This pin is connected to the ground via a coupling capacitor, the same one as used for the input pin, when the pin is not used as an input pin in the BTL mode.<br>Standard input resistance: 10 kΩ     | 0.7                        |
| 6   | REF1          | Output pin for internal reference voltage (high impedance) for phase compensation  | 0.7                        |
| 7   | REF2          | Output pin for internal reference voltage (low impedance)  | 0.7                        |
| 8   | NC            |  | —                          |
| 9   | Vcc           | Power supply pin   | —                          |
| 10  | OUT2          | Output pin for CH2   | 0.55<br>(0.74 during MUTE) |
| 11  | GND2          | Grounding mainly for the output stage  | —                          |
| 12  | OUT1          | Output pin for CH1   | 0.55<br>(0.74 during MUTE) |
| 13  | MUTE          | Switch pin to activate the MUTE operation<br>H: (power supply) normal operation<br>L: (ground) MUTE<br>                                | —                          |
|     |               | (standard internal equivalent circuit)   |                            |
| 14  | Pre Amp out 1 | Pin to be connected with a load resistor in the preceding stage buffer amplifier of CH1. See the Electrical Test Circuit application circuit of BTL mode, and DUAL mode.   | 0.7                        |

(T<sub>a</sub> = 25°C, See the Electrical Characteristics Test Circuit)

Electrical Characteristics

| No. | Test Item                    | Symbol              | Switches to be set ON         | Power Source I/O Conditions    |  |   | Test Points  | Measurement Method and Contents | Min. | Typ. | Max. | Unit   |
|-----|------------------------------|---------------------|-------------------------------|--------------------------------|--|---|--|---------------------------------|------|------|------|--|
|     |                              |                     |                               | Supply Voltage V <sub>CC</sub> | Signal Input V <sub>IN</sub>           | Signal Output V <sub>OUT</sub>          |  |                                 |      |      |      |  |
| 1   | Current consumption 1        | I <sub>ON</sub>     | S5                            | 1.25(V)                        |  | A METER(DC)                             | Current consumption in BTL with an 8 Ω load and no signal input                        | 2.5                             | 5.0  | 11.0 | mA   |  |
| 2   | Output offset voltage        | V <sub>Δ12</sub>    | S7                            | ↓                              |  | V <sub>OUT</sub> (DC)                   | CH1 DC output voltage → (CH2 DC output voltage) is calculated in BTL with an 8 Ω load. | -30                             | 0    | +30  | mV   |  |
|     |                              |                     | S6                            | ↓                              |  | V <sub>OUT</sub> (DC)                   |  |                                 |      |      |      |  |
| 3   | Current consumption 2        | I <sub>OFF</sub>    | S3, S4, S5                    | 2.0(V)                         |  | A METER(DC)                             | Current consumptions in Power OFF, MUTE  |                                 | 0    | 10   | μA   |  |
| 4   | Gain BTL 1                   | G <sub>BTL1</sub>   | S1                            | 1.25(V)                        | Adjustment                             | V <sub>IN</sub> , V <sub>OUT</sub> (AC) | Gain for the output of -20 dBm   | 23.5                            | 25.5 | 28.0 | dB   |  |
| 5   | Gain BTL 2                   | G <sub>BTL2</sub>   | S2                            | 0.9(V)                         | ↓                                      | ↓                                       |  | 22.5                            | 24.5 | 28.0 | dB   |  |
| 6   | ΔGain BTL                    | ΔG <sub>BTL</sub>   | Arithmetic                    | —                              | —                                      | —                                       | ΔG <sub>BTL</sub> = G <sub>BTL1</sub> - G <sub>BTL2</sub>                              |                                 | 1.0  | 3.0  | dB   |  |
| 7   | THD BTL                      | T <sub>HDBTL</sub>  | S1                            | 1.25(V)                        | Adjustment                             | V <sub>OUT</sub> (AC)                   | THD (BTL) for the output of -10 dBm  |                                 | 1.5  | 2.5  | %    |  |
| 8   | EIAJ maximum output BTL      | P <sub>BTLMAX</sub> | S1                            | 1.5(V)                         | ↓                                      | V <sub>OUT</sub> (AC)                   | BTL output for the output THD of 10%   | 70                              | 82   |      | mW   |  |
| 9   | Ripple output voltage BTL    | R <sub>IPBTL</sub>  |                               | 1.0(V)                         |  | V <sub>IN</sub> , V <sub>OUT</sub> (AC) | Check the PTL output by overlaying the ripple voltage with 1 V power supply.           |                                 | -79  | -65  | dBm  |  |
|     |                              |                     |                               | 2.0(V)                         |  | V <sub>OUT</sub> (AC)                   |  |                                 |      |      |      | Noise output voltage in BTL with an 8 Ω load and no signal input |
| 10  | Noise output voltage BTL     | N <sub>BTL</sub>    |                               | 2.0(V)                         |  | V <sub>OUT</sub> (AC)                   | BTL output in the MUTE state   |                                 |      | -100 | dBm  |  |
| 12  | Gain DUAL                    | G <sub>DUAL1</sub>  | S1, S7, S8, S9, S10, S11, S12 | 1.25(V)                        | Adjustment                             | V <sub>IN</sub> , V <sub>OUT</sub> (AC) | Gain for individual outputs of -26 dBm, 8 Ω load                                       | 19.0                            | 21.0 | 24.0 | dB   |  |
|     |                              |                     |                               |                                |  |   |  |                                 |      |      |      | G <sub>DUAL2</sub>   |
| 13  | Channel balance              | ΔG <sub>D12</sub>   | Arithmetic                    | —                              | —                                      | —                                       | ΔG <sub>D12</sub> = G <sub>DUAL1</sub> - G <sub>DUAL2</sub>                            | -1.5                            | 0    | +1.5 | dB   |  |
| 14  | THD DUAL                     | T <sub>HDD1</sub>   | S1, S7, S8, S9, S10, S11, S12 | 1.25(V)                        | Adjustment                             | V <sub>OUT</sub> (AC)                   | THD for individual outputs of -16 dBm.   |                                 | 0.9  | 2.5  | %    |  |
|     |                              |                     |                               |                                |  |   |  |                                 |      |      |      | T <sub>HDD2</sub>  |
| 15  | EIAJ maximum output DUAL     | P <sub>D1 MAX</sub> | S1, S7, S8, S9, S10, S11, S12 | 1.5(V)                         | ↓                                      | ↓                                       | Output for the individual CH THD's of 10%, 8 Ω load.                                   | 16                              | 20   |      | mW   |  |
|     |                              |                     |                               |                                |  |   |  |                                 |      |      |      | P <sub>D2 MAX</sub>  |
| 16  | Cross talk between DUAL CH'S | C <sub>TAB</sub>    | S1, S6, S8, S9, S10, S11, S12 | 1.25(V)                        | Test 17 equivalent to OSC in Channel 1 | V <sub>IN</sub> , V <sub>INT</sub> (AC) | The output level at the CH opposite with the input CH                                  |                                 | -51  | -45  | dB   |  |
|     |                              |                     |                               |                                |  |   |  |                                 |      |      |      | C <sub>TBA</sub>   |

\* dBm (600 Ω) 0 dBm: 774.6m Vrms  
 \* BPF is set to 400 Hz to 30 kHz for AC measurement.

\* Both signal input V<sub>IN</sub> and ripple input V<sub>IP</sub> are 1 kHz.



Electrical Characteristics Test Circuit

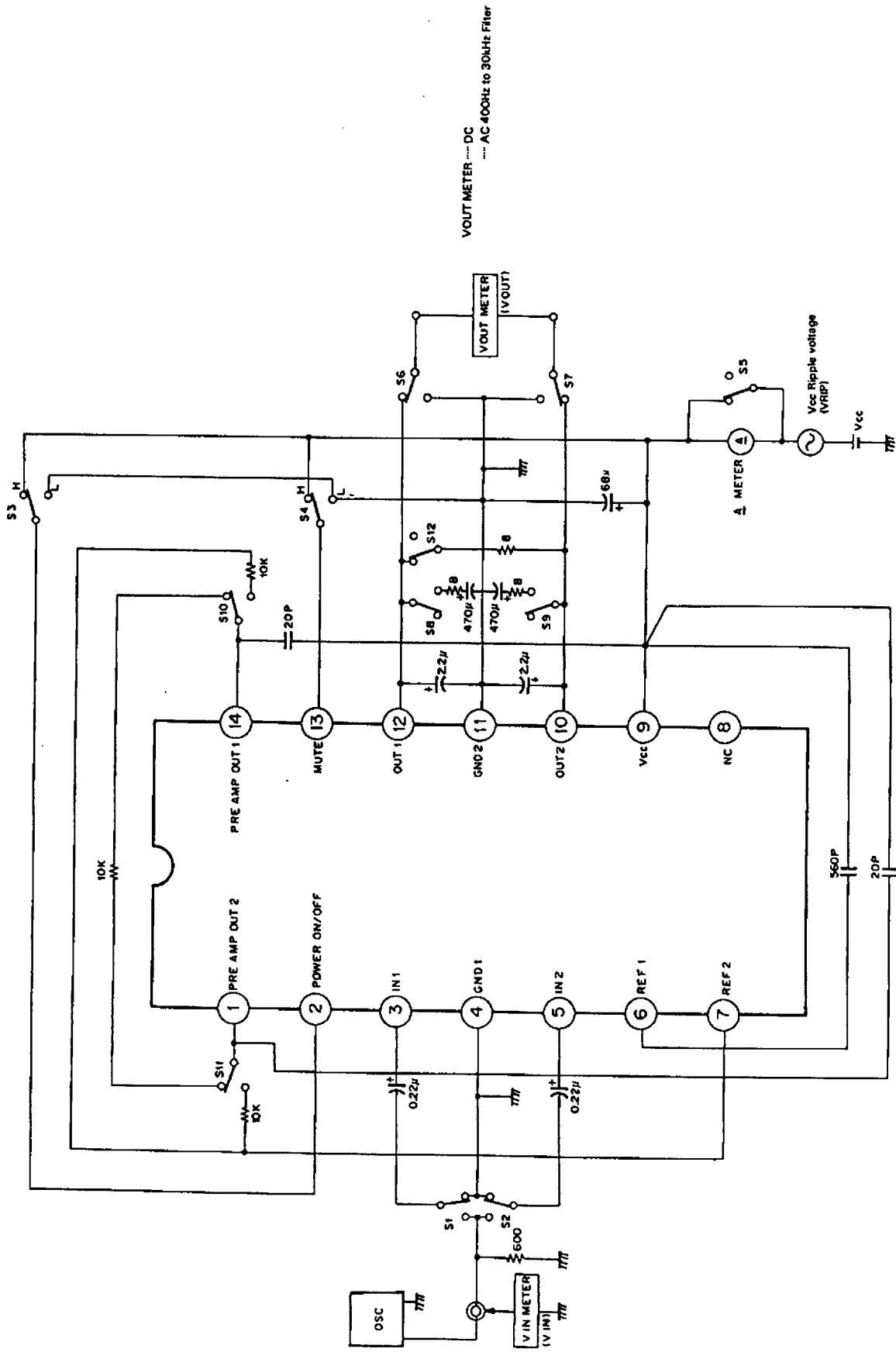

## Description of Operation

The CX20172 incorporates two buffer amplifiers in the preceding stage and two current input amplifiers in the succeeding stage. Selection between the BTL amplifier and DUAL amplifier is made by altering the method of attaching external components as shown in the Application Circuit.

### 1. BTL mode (see the BTL mode Application Circuit)

- Items 1 to 11 in the Electrical Characteristics are the characteristics for the BTL mode.
- Input through either IN1 or IN2 results in a reverse-phase output at the output side of the input channel and in the same-phase output at the other, to enable BTL driving of the load between OUT1 and OUT2.
- Ground the unused input pins via a coupling capacitor which is the same one used for the input pin.
- Gain setting can be altered by changing values of external resistors connected between Pre Amplifier out 1 and 2. Gain decreases as a resistor value between Pin 1 and Pin 14 increases. Reducing a resistor value to increase the gain results in larger output offset and current consumption. I/O characteristics, distortion factor and maximum output change according to resistor values. Specify a set value, therefore, in view of input level, output level, distortion and power consumption.
- The value of a phase-compensation capacitor can be altered considerably according to patterns on mounting substrate.

### 2. Dual mode (see the Dual mode Application Circuit)

- Items 12 to 16 in the Electrical Characteristics are the characteristics for the Dual mode.
- Simultaneous input through IN1 and IN2 results in reverse-phase outputs at both output pins to enable DUAL driving.
- Gain setting can be altered by changing values of external resistors connected between Pre Amplifier out 1 and 2 and REF2, similarly to the BTL mode. Gain decreases as resistor value increases. I/O characteristics, distortion factor and maximum output change according to resistor values. The same consideration as in the BTL mode is, therefore, required. Current consumption has, however, less dependency on the gain than in BTL.
- The value of a phase-compensation capacitor can be altered considerably according to patterns on mounting substrate.

### 3. Common functions

#### 3.1 REF block

- Circuit block to generate reference voltage.  
REF1 (Pin 6) is an output from the block (high impedance). This is reduced in its impedance through the buffer amplifier to generate REF2 (Pin 7).

#### 3.2 Mute, Power ON/OFF block

- Grounding the Mute pin (Pin 13) results in the interrupt of the signal route to generate DC voltage of approx. 700 to 765 mV at both output sides of channel (CH).
- Grounding the Power ON/OFF pin (Pin 2) results in the OFF state of the REF block and the output is grounded.

BTL Mode Application Circuit

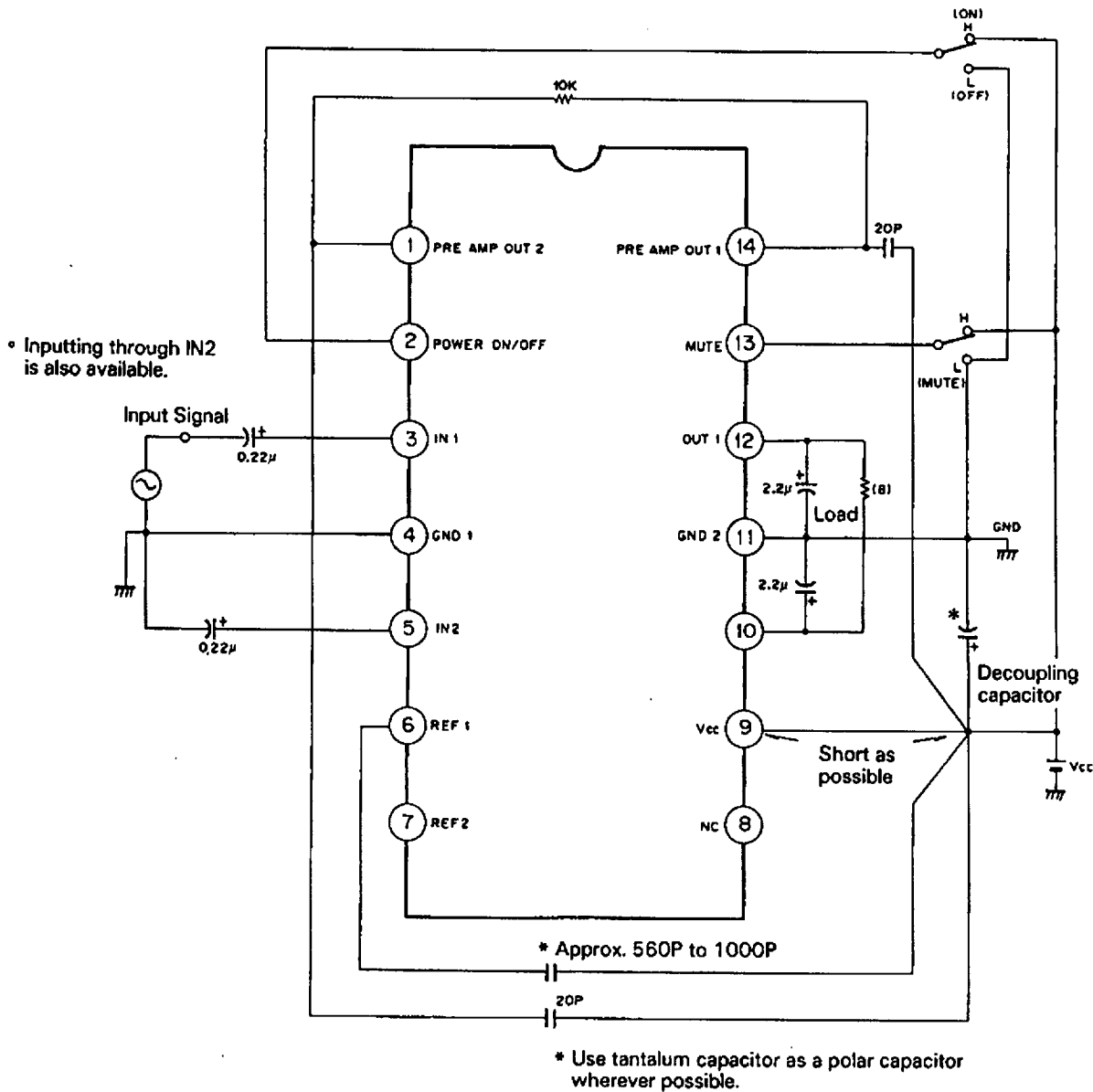

Note) Place a decoupling capacitor between Vcc and GND as close as possible to Vcc and GND2. Assuming this point as the point of power supply or grounding, place (\*)-marked components as close as possible.

Values of the decoupling capacitor can be altered according to the pattern layouts.

Dual Mode Application Circuit

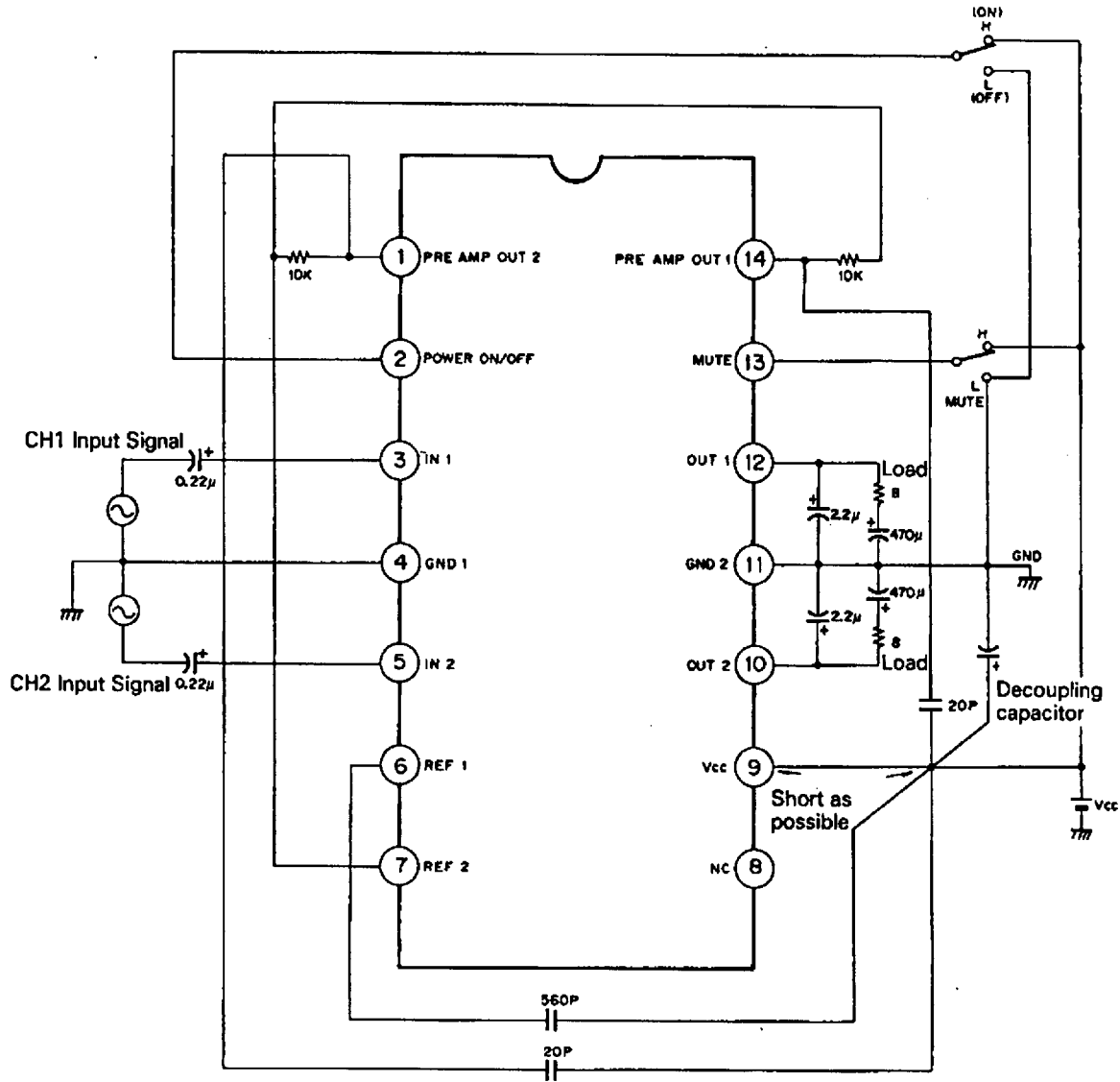

\* Use tantalum capacitor as a polar capacitor wherever possible.

Note) Notes for the above are almost same as in BTL.

**Standard Characteristics**

- See "Electrical Characteristics Test Circuit" for the test circuit.
- A resistor between Pin 1 and Pin 14 to determine the gain is of 10 kΩ, unless otherwise specified.
- Measuring temperature is 25°C, unless otherwise specified.

**Current consumption ION, IMUTE, IOFF — Vcc**

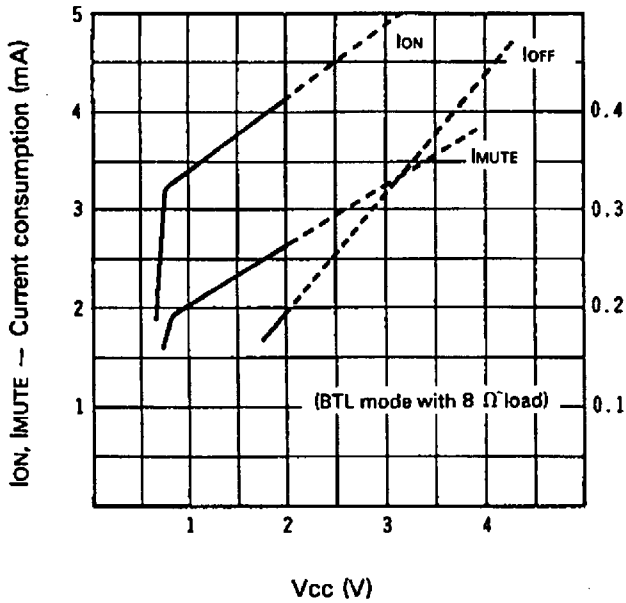

**Output DC electric potential — Vcc**

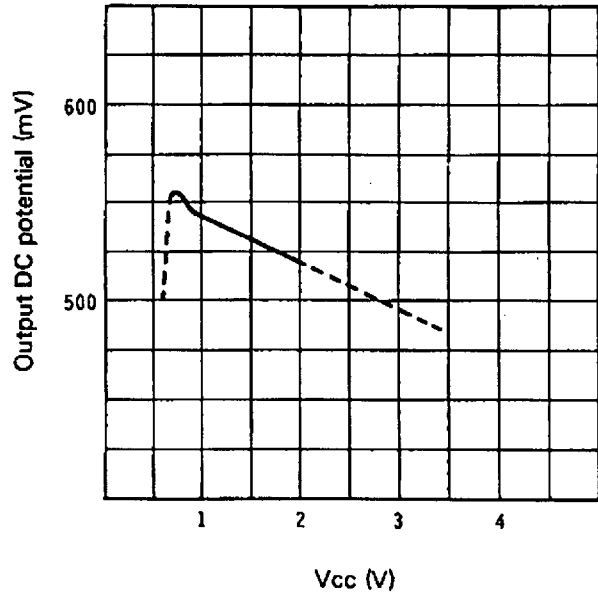

ION and IOFF are measured conforming to the methods in the measurement 1 and 3.  
 IMUTE represents the current consumption with S4 and S5 ON.

**BTL Mode, I/O characteristics (Vcc Parameter)**

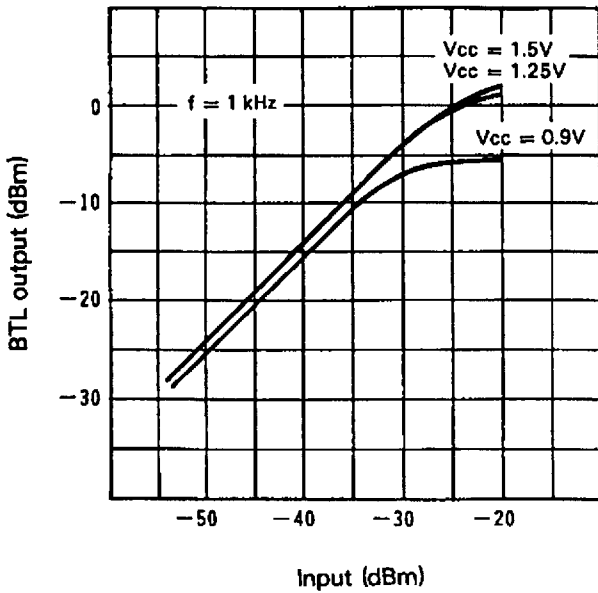

**BTL Mode distortion — input level (Vcc Parameter)**

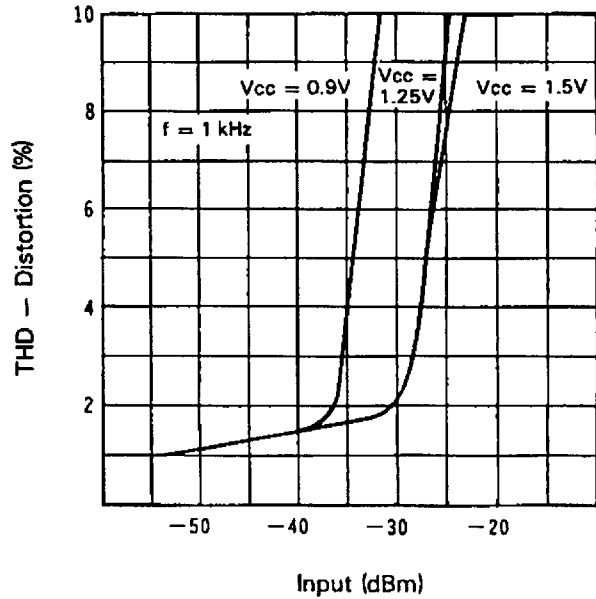



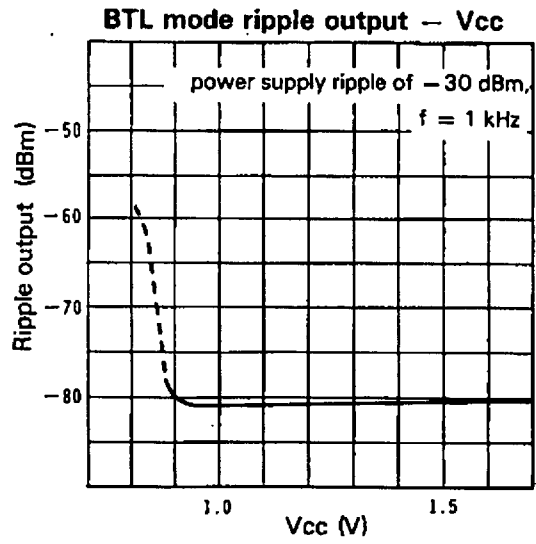
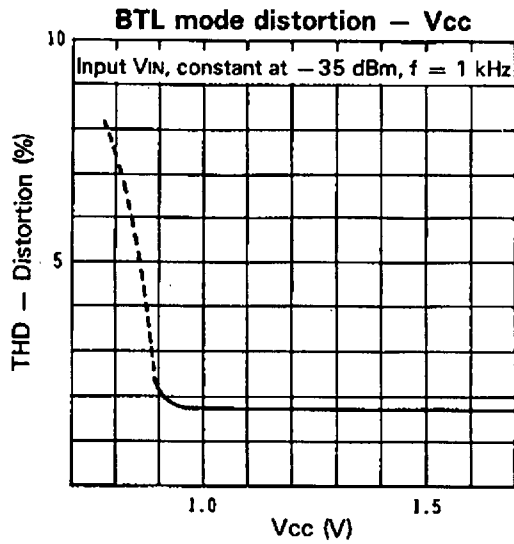

BTL mode output frequency characteristics

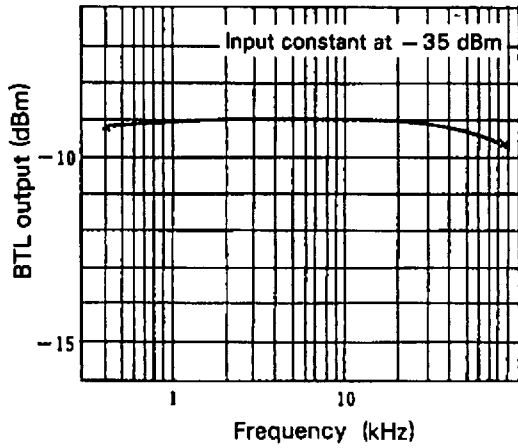

BTL mode distortion frequency characteristics

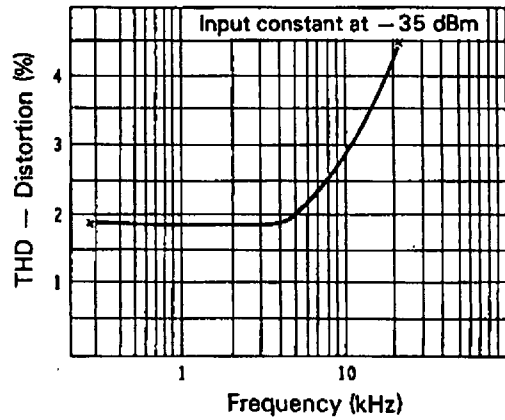

Dual mode I/O characteristics (Vcc Parameter)

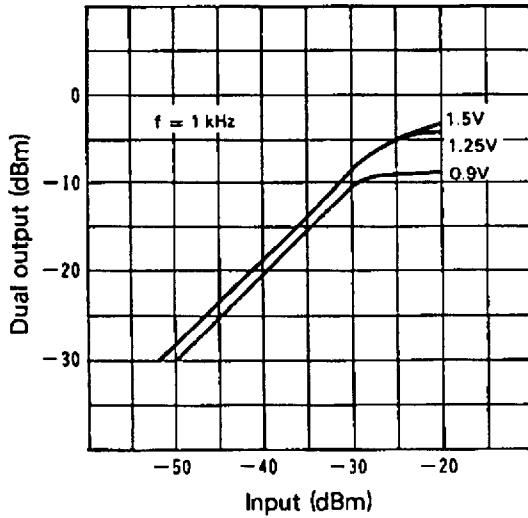

Dual mode distortion - input level (Vcc Parameter)

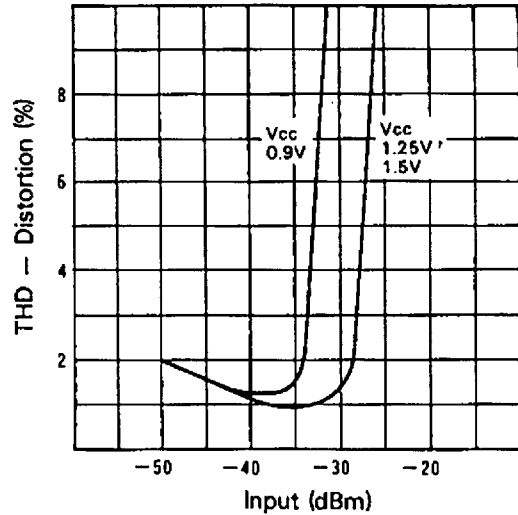

**Dual mode distortion**  
 - Vcc, Cross talk Vcc 1-2

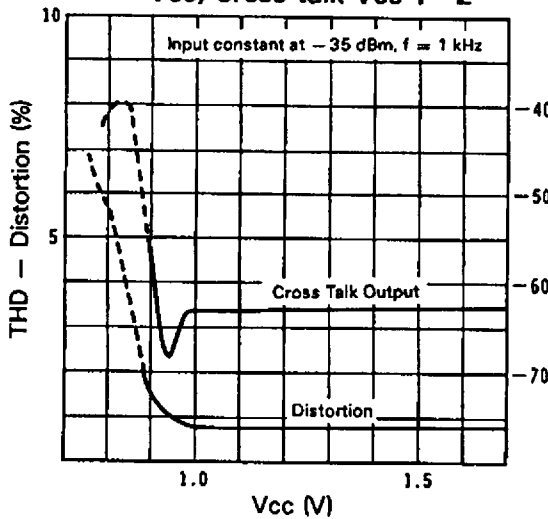

**Dual mode cross talk output frequency characteristics**

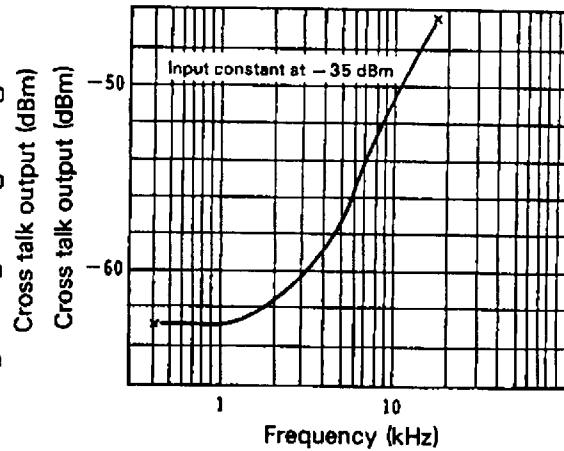

**BTL Mode output level - Vcc (Temperature characteristics)**

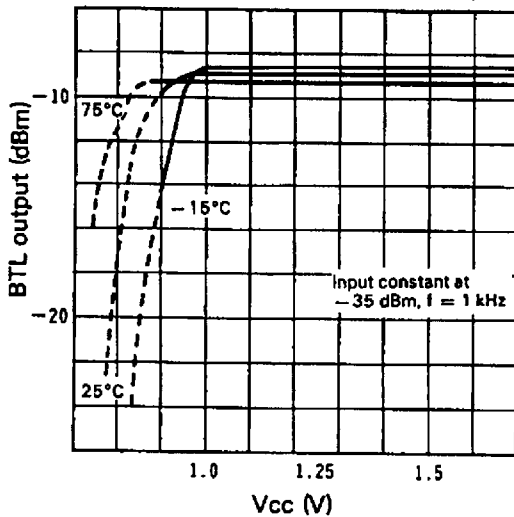

**Dual mode output level - Vcc (Temperature characteristics)**

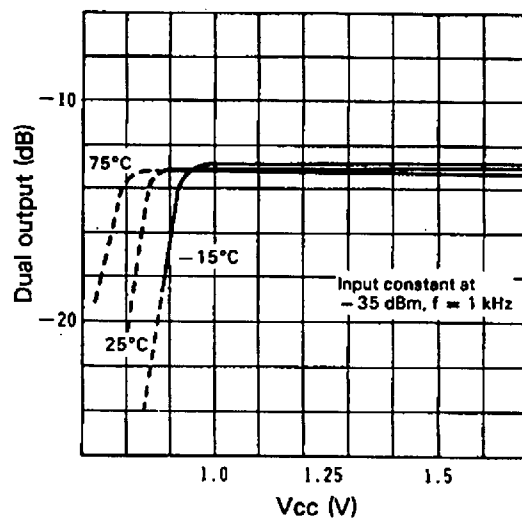

**BTL mode external resistance - gain between pin 1 and 14**

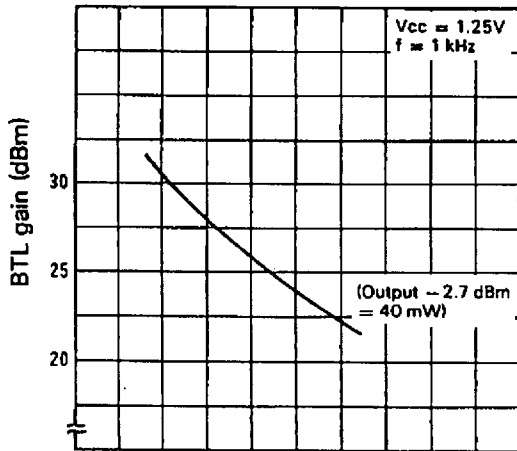

**BTL mode external resistance - distortion between pin 1 and 14**

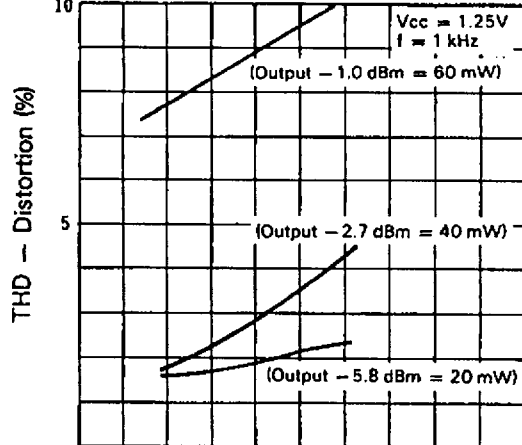

External resistor between pin 1 and 14 (kΩ)

External resistor between pin 1 and 14 (kΩ)

**BTL mode external resistance –  
maximum output between pin 1 and 14**

