

CXA1391Q/R

Processing IC for Complementary Color Mosaic CCD Camera

Description

The CXA1391Q/R is a bipolar IC developed for signal processing in complementary color mosaic CCD cameras.

Features

- Low power consumption (170mW)
- Number of delay lines used for signal processing can be selected according to the system requirements
- The LPF peripheral to 1H delay line is built in

Structure

Bipolar silicon monolithic IC

Applications

Complementary color mosaic CCD cameras

Block Diagram and Pin Configuration

(Top View)

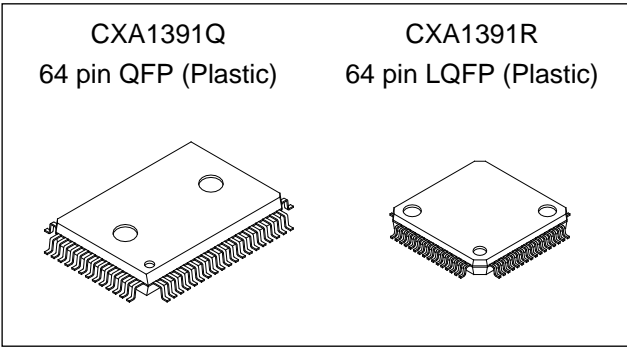
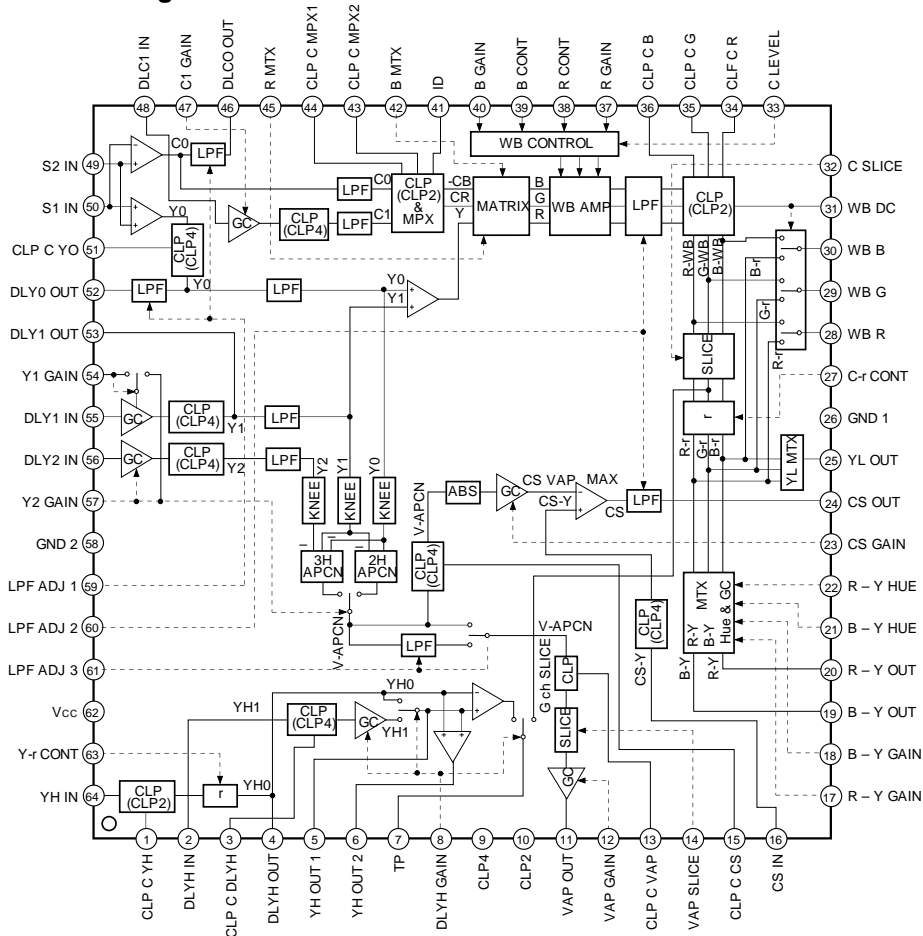

Absolute Maximum Ratings

- Supply voltage V_{CC} 7 V
 - Storage temperature T_{stg} -55 to +150 °C
 - Allowable power dissipation P_D 690 mW
- (LQFP: $T_a = 25^\circ\text{C}$, without P.C.B)

Recommended Operating Conditions

- Supply voltage V_{CC} 4.75 to 5.25 V
- Ambient temperature T_{opr} -20 to +75 °C

Sony reserves the right to change products and specifications without prior notice. This information does not convey any license by any implication or otherwise under any patents or other right. Application circuits shown, if any, are typical examples illustrating the operation of the devices. Sony cannot assume responsibility for any problems arising out of the use of these circuits.

Pin Description

Pin No.	Symbol	Pin voltage	Equivalent circuit	Description
1	CLP C Y _H	3 to 3.5V		Capacitor connecting pin for Y _H clamp (Clamp at CLP2)
2	DL Y _H IN	3.65V		DL Y _H signal input pin (Input from 1H delay line) Sig: Typ. 200mV (Positive polarity)
3	CLP C DL Y _H	2.6 to 3.8V		Capacitor connecting pin for DL Y _H clamp (Clamp at CLP4)
4	DL Y _H OUT	2.7 to 3.1V		DL Y _H signal output pin (To 1H delay line) Sig: Typ. 400mV Max. 600mV (Negative polarity)

Note) Pin voltage for input and output pins indicate black level.

Pin No.	Symbol	Pin voltage	Equivalent circuit	Description
5	Y _H OUT1	1.9 to 2.3V		<p>Y_H1 signal output pin</p> <p>Sig: Typ. 1V Max. 1.5V (Positive polarity)</p>
6	Y _H OUT2	1.9 to 2.3V		<p>Y_H2 signal output pin</p> <p>Sig: Typ. 1V Max. 1.5V (Positive polarity)</p>
7	TP	2.6 to 3.0V (Y _H) 2.5 to 2.9V (G)		<p>TP OUT (adjusting pin)</p> <p>1H mode: Outputs Y_H1–Y_H0 0H mode: Outputs G_{ch} C-slice OUT (Mode selection is executed through Pin 8)</p>
8	DL Y _H GAIN	0V (0H Mode) 1.8 to 5V (1H Mode)		<p>DL Y_H signal gain control pin (For 1H delay line gain compensation of Y_H) TP (Pin 7) mode selection 0H Mode: 0V 1H Mode: 1.8 to 5V</p>
54	Y1 GAIN	0V: Common control by Pin 57 1.8 to 5V Independent control		<p>DLY₁ signal gain control pin (1H delay line gain compensation)</p> <p>0V: DLY₁ signal gain control is executed in common with DLY₂ signal gain control. 1.8 to 5V: DLY₁ signal gain control is executed independently from DLY₂ signal gain control.</p>

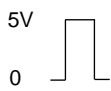
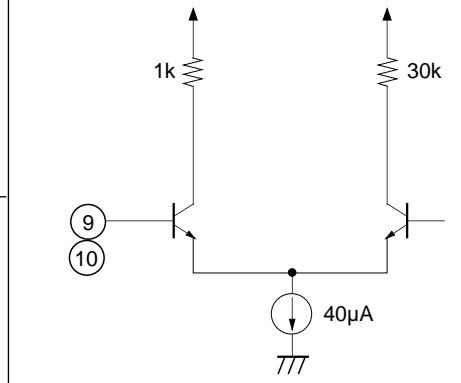
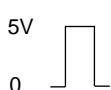
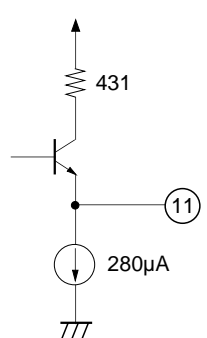
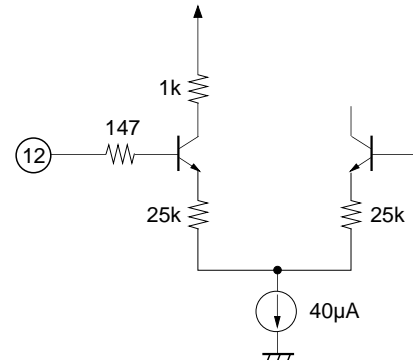
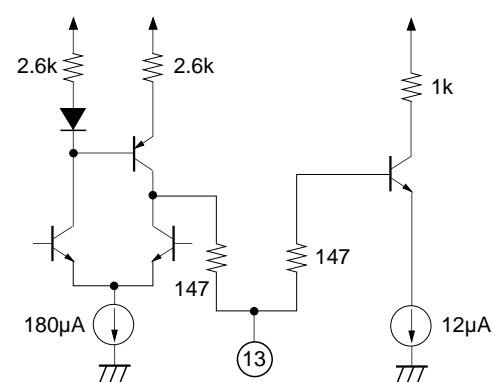
Pin No.	Symbol	Pin voltage	Equivalent circuit	Description
9	CLP4	5V 		CLP4 pulse input pin (BLK clamp) (CMOS level input, $V_{TH} = 2.5V$)
10	CLP2	5V 		CLP2 pulse input pin (OPB clamp) (CMOS level input, $V_{TH} = 2.5V$)
11	VAP OUT	2.6 to 3.0V		V-APCN signal output pin* Sig: Max. 1.2Vp-p
12	VAP GAIN	1.8 to 5V (Control)		V-APCN signal output level adjustment pin
13	CLP C VAP	3.4 to 3.8V		Capacitor connecting pin for VAP clamp (Clamp at CLP4)

* V-APCN: Vertical Aperture Compensation

Pin No.	Symbol	Pin voltage	Equivalent circuit	Description
14	VAP SLICE	1.8 to 5V (Control)		V-APCN signal dark slice volume adjustment pin
15	CLP C CS	3.5 to 3.7V		Capacitor connecting pin for CS clamp (Clamp at CLP4)
16	CS IN	C-Couple input 2.9 to 3.3V		AGC CS signal input pin Sig: Max. 1V

17	R-Y GAIN	0V: R-G output 1.8 to 5V: R-Y output		R-Y signal output level adjustment pin Pin 20 Mode select 0V: R-G output 1.8 to 5V: R-Y output
18	B-Y GAIN	0V: B-G output 1.8 to 5V: B-Y output		B-Y signal output level adjustment pin Pin 19 Mode select 0V: B-G output 1.8 to 5V: B-Y output
23	CS GAIN	1.8 to 5V (Control)		V-APCN CS signal gain control pin
19	B-Y OUT	2.75 to 3.15V (Hue OFF)		
20	R-Y OUT	2.35 to 2.75V (Hue ON)		
46	DLC ₀ OUT	1.8 to 2.2V		
52	DLY ₀ OUT	1.4 to 1.8V		
53	DLY ₁ OUT	2.8 to 3.2V		
21	B-Y Hue	0V:		B-Y hue control pin
				R-Y hue control pin

Pin No.	Symbol	Pin voltage	Equivalent circuit	Description
24	CS OUT	1.5 to 1.8V		CS signal output pin Sig: Max. 1V
25	YL OUT	1.9 to 2.3V		YL signal output pin
26	GND1			GND
27	C-γ CONT	0V: Typ. γ curve		Chroma (R.G.B) γ curve adjustment pin

Pin No.	Symbol	Pin voltage	Equivalent circuit	Description
28	WB R	1.4 to 2V		R signal output pin WB Mode: Sig: Typ. 400mV γ Mode: Sig: Typ. 500mV
29	WB G	1.4 to 2V		G signal output pin WB Mode: Sig: Typ. 400mV γ Mode: Sig: Typ. 500mV
30	WB B	1.4 to 2V		B signal output pin WB Mode: Sig: Typ. 400mV γ Mode: Sig: Typ. 500mV
31	WB DC	1.4 to 2V		When used as output pin, it is an Auto WB DC output pin. Pin 28, 29 and 30 turn to WB mode. When connected to Vcc: Pins 28, 29 and 30 turn to γ mode.
32	C SLICE	0V: Slice OFF		Chroma (R.G.B) signals dark slice level adjustment pin
33	C LEVEL	1.8 to 5V (Control)		Chroma (R.G.B) gain control pin (Chroma modulation factor control for all 3 channels)
47	C ₁ GAIN	1.8 to 5V (Control)		DL C ₁ signal gain control pin (1H delay line gain compensation)

Pin No.	Symbol	Pin voltage	Equivalent circuit	Description
34	CLP C R	3.0 to 3.6V		Capacitor connecting pin for R WB amplifier clamp (Clamp at CLP2)
35	CLP C G	3.0 to 3.6V		Capacitor connecting pin for G WB amplifier clamp (Clamp at CLP2)
36	CLP C B	3.0 to 3.6V		Capacitor connecting pin for B WB amplifier clamp (Clamp at CLP2)
37	R GAIN	1.8 to 5V (Control)		Rch WB amplifier gain control pin (Pre-WB)
40	B GAIN	1.8 to 5V (Control)		Bch WB amplifier gain control pin (Pre-WB)
38	R CONT	2.5 to 4.6V		Rch WB amplifier gain control pin
39	B CONT	2.5 to 4.6V		Bch WB amplifier gain control pin

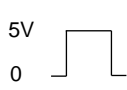
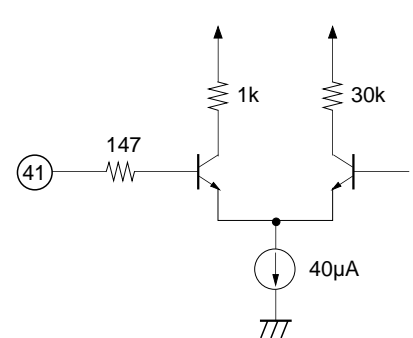
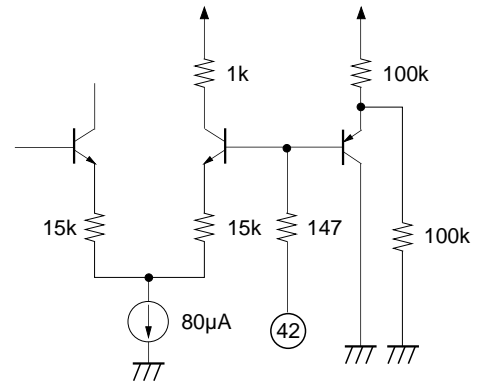
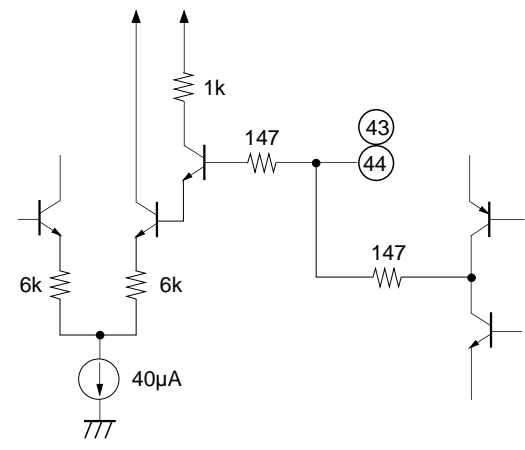
Pin No.	Symbol	Pin voltage	Equivalent circuit	Description
41	ID	 <p>5V 0</p>		<p>ID pulse (color discrimination pulse) input pin (CMOS level $V_{IH} = 2.5V$)</p> <p>ID = L $C_0 \rightarrow C_R$ $C_1 \rightarrow C_B$</p> <p>ID = H $C_0 \rightarrow C_B$ $C_1 \rightarrow C_R$</p>
42	B MTX	<p>1.8 to 5V (Control)</p> <p>0V (Preset)</p>		<p>B signal operations MTX coefficient adjustment pin (Coefficient 0.22) Refer to Note 2.</p>
43	CLP C MPX2	2.7 to 3.1V		<p>Capacitor connecting pin for MPX clamp (Clamp at CLP2)</p>
44	CLP C MPX1	2.7 to 3.1V		

Pin No.	Symbol	Pin voltage	Equivalent circuit	Description
45	R MTX	1.8 to 5V (Control) 0V (Preset)		R signal operations MTX coefficient adjustment pin (Coefficient 0.617) Refer to Note 2.
48	DLC ₁ IN	C-Couple input 3.1 to 3.5V		DL C ₁ signal input pin Sig: Typ. 150mVp-p (Negative polarity)
55	DLY ₁ IN	C-Couple input 3.6 to 4.0V		DL Y ₁ signal input pin Sig: Typ. 150mVp-p (Negative polarity)
56	DLY ₂ IN	C-Couple input 3.6 to 4.0V		DL Y ₂ signal input pin Sig: Typ. 150mVp-p (Negative polarity)
49	S2 IN	1.9V		S2 signal input pin Sig: Typ. 500mV Max. 1500mV
50	S1 IN	1.9V		S1 signal input pin Sig: Typ. 500mV Max. 1500mV

Pin No.	Symbol	Pin voltage	Equivalent circuit	Description
51	CLP C Y ₀	3.3 to 3.7V		Capacitor connecting pin for Y ₀ clamp (Clamp at CLP4)
57	Y ₂ GAIN	1.8 to 5V (3H Mode) 0V (2H Mode)		DL Y ₂ signal gain control pin (1H delay line gain compensation) V-APCON mode selection 0V: 2H Mode 1.8 to 5V: 3H Mode
58	GND2			GND
59	LPF Adj. 1	1.8 to 2.2V		Connecting pin of the external resistor that determines the characteristics of the LPF for 1H DL. (External resistor in the range of 15 to 27kΩ)
60	LPF Adj. 2	1.8 to 2.2V		Connecting pin of the external resistor that determines the characteristics of the chroma LPF (LPF for R, G, B, CS). (External resistor in the range of 15 to 62kΩ)

Pin No.	Symbol	Pin voltage	Equivalent circuit	Description
61	LPF Adj. 3	1.8 to 2.2V		<p>Connecting pin of the external resistor that determines the characteristics of the LPF for V-APCN. (External resistor in the range of 15 to 62kΩ) When connected to Vcc, the LPF for V-APCN turns OFF.</p>
62	Vcc			Power supply 5V (Typ.)
63	Y-γ CONT	<p>0V (Typ. γ curve)</p> <p>1.8 to 5V (Control)</p>		YH γ curve adjustment
64	YH IN	0.95V		<p>YH signal input</p> <p>Sig: Typ. 220mV Max. 660mV</p>

Electrical Characteristics

Item	Symbol	Conditions	Min.	Typ.	Max.	Unit
Current consumption	ID		25	34.5	43	mA
S2-S1 Amp Gain	SSG	Input: S1 IN = -62.5mV, S2 IN = 62.5mV Calculations: DLC ₀ OUT/S1 IN	-3	-1.95	-1	dB
DLC ₁ gain control	Max.	DLC ₁ H Input: DLC ₁ IN = 100mV Conditions: C ₁ Gain = 5V C-level = 5V Calculations: (WB-R/DLC ₁ IN) -CG Note2)	6	7	9	dB
	Min.	DLC ₁ L Conditions: C ₁ Gain = 0V (Others same as DLC ₁ H)	-2	-0.85	0	dB
S1+S2 Amp	SAG	Input: S1 IN = 500mV Calculations: DLY ₀ OUT/S1 IN	-15	-14	-13	dB
Chroma matrix (Gch) Note 3)	Gch Y	GY Input: S1 IN = S2 IN = 300mV Conditions: C-level = 5V Calculations: WB-G (ID = H, L average)	80	100	120	mV
	C _R /Y	GCR Input: S1 IN = S2 IN = 62.5mV Conditions: C-level = 5V Calculations: WB-G/GY (ID = L)	0.9	1	1.1	—
	-C _B /Y	GCB ID = H (Others same as GCR)	-1.1	-1	-0.9	—
Chroma matrix (Rch) Note 3)	Rch C _R	RCR Input: S1 IN = -62.5mV, S2 IN = 62.5mV Conditions: C-level = 5V Calculations: WB-R (ID = L)	70	85	100	mV
	Y (Preset)	RYP Input: S1 IN = S2 IN = 500mV Conditions: C-level = 5V Calculations: WB-R/RCR (ID = H)	0.15	0.168	0.186	—
	Y (Max.)	RYH RMTX = 5V (Others same as RYP)	0.22	0.25	0.27	—
	Y (Min.)	RYL RMTX = 1.8V (Others same as RYP)	0.11	0.125	0.14	—
Chroma matrix (Bch) Note 3)	Bch-C _B	BCB Input: S1 IN = 62.5mV, S2 IN = -62.5mV Conditions: C-level = 5V Calculations: WB-B (ID = H)	80	100	120	mV
	Y (Preset)	BYP Input: S1 IN = S2 IN = 500mV Conditions: C-level = 5V Calculations: WB-B/BCB (ID = H)	0.2	0.22	0.24	—
	Y (Max.)	BYH BMTX = 5V (Others same as BYP)	0.31	0.34	0.37	—
	Y (Min.)	BYL BMTX = 1.8V (Others same as BYP)	0.13	0.15	0.17	—

	Item	Symbol	Conditions	Min.	Typ.	Max.	Unit
WB GAIN	RCONT Max.	RCH	Input: $DLC_{1IN} = -200mV$ Conditions: C-level = 5V $RCONT = 4.6V$ (ID = H) Calculations: WB-R/WB-RTyp. Note 4) WB-R Typ. is the tested output of WB-R when RCONT is set to 4V (Other inputs, conditions same as RCH)	7.5	8.2	8.5	dB
	RCONT Min.	RCL	Test: $RCONT = 2.5V$ (Others same as RCH)	-8.4	-7.9	-7.4	dB
	BCONT Max.	BCH	Input: $DLC_{1IN} = 150mV$ Conditions: C-level = 5V $BCONT = 4.6V$ (ID = L) Calculations: WB-B/WB-BTyp. Note 4) WB-B Typ. is the tested output of WB-B when BCONT is set to 4V (Other inputs, conditions same as BCH)	7.5	8.2	8.5	dB
	BCONT Min.	BCL	Test: $BCONT = 2.5V$ (Others same as BCH)	-8.4	-7.9	-7.4	dB
	RGAIN Max.	RGH	Input: $DLC_{1IN} = -200mV$ Conditions: $RCONT = 2.5V$ $RGAIN = 5V$ C-level = 5V (ID = H) Calculations: WB-R/WB-RMin. WB-R Min. is the tested WB-R, when tested under the same conditions as RCL.	8.6	9.2	—	dB
	BGAIN Max.	BGH	Input: $DLC_{1IN} = 150mV$ Conditions: $BCONT = 2.5V$ $BGAIN = 5V$ C-level = 5V (ID = L) Calculations: WB-B/WB-BMin. WB-B Min. is the tested WB-B, when tested under the same conditions as BCL.	11.4	12.2	—	dB

	Item	Symbol	Conditions	Min.	Typ.	Max.	Unit
Bch color difference matrix Note 5)	R-G OUT/ WB-B	BMBY	Input: S1IN = 200mV S2IN = 160mV DLC1IN = 220mV Conditions: C-γ CONT = WB DC = C-Slice = C-level = 5V RCONT = 2.5V BCONT = 4.6V (ID = L) Calculations: B-Y OUT/WB-B	0.4	0.44	0.48	—
	R-Y OUT/ WB-B	BMRY	Conditions: R-Y GAIN = 1.8V Calculations: R-Y OUT/WB-B (Others same as BMBY)	-0.24	-0.21	-0.17	—
	B-Y GAIN Max.	BMG	Conditions: BCONT = 4V 1. B-Y OUT is tested when B-Y gain = 0V and taken as A. (Other conditions are the same as BMBY) 2. B-Y OUT is tested when B-Y gain = 5V and taken as B. (Other conditions are the same as BMBY) Calculations: B/A	3.0	3.3	—	—
	B-Y Hue Max.	BMHH	Conditions: B-Y HUE = 1.8V (Others same as BMBY) Calculations: R-Y OUT/B-Y Typ. B-Y Typ. is the value of the tested B-Y OUT when B-Y hue=0V (Other conditions are the same as BMBY). Note 6)	0.58	0.68	—	—
	B-Y Hue Min.	BMHL	B-Y HUE = 5V (Others same as BMHH)	—	-0.67	-0.58	—
Gch color difference matrix Note 5)	R-Y/R-G	GMR	Input: S1IN = 830mV S2IN = 660mV DLC1IN = -230mV Conditions: WB-DC = C-level = 5V RCONT = BCONT = 2.5V 1. R-Y OUT is tested when R-Y gain = 0V and taken as A. 2. R-Y OUT is tested when R-Y gain = 1.8V and taken as B. Calculations: B/A	0.81	0.85	0.89	—
	B-Y/B-G	GMB	Input: (The same as GMR) Conditions: 1. B-Y OUT is tested when B-Y gain = 0V and taken as A. 2. B-Y OUT is tested when R-Y gain = 1.8V and taken as B. (Others same as GMR) Calculations: B/A	0.63	0.66	0.7	—

	Item	Symbol	Conditions	Min.	Typ.	Max.	Unit
C-Slice	Typ.–Min.	CSLL	Input: DLY ₁ IN = –400mV Conditions: C-level = 5V Y ₁ GAIN = 1.8V C-Slice = 1.8V (ID = H) Calculations: C-Slice Typ. -TP C-Slice Typ. is the TP output of C-Slice = 0V.	0	5	15	mV
	Typ.–Max.	CSLH	Conditions: C-Slice =5V (Others same as CSLL)	95	120	145	mV
Gch γ curve	C- γ CONT=0V Gch-WB=400mV	γ Typ.	Input: DLY ₁ IN = –200mV S1IN = S2IN = 500mV Conditions: Y ₁ GAIN = 1.8V C-level is valied and adjusted to obtain 400mV at WB-G. After that C-level is fixed during test. WB-DC is set to OPEN during C-level adjusted and set to 5V during test. Calculations: WB-G is tested.	450	500	550	mV
	C- γ CONT=0V Gch-WB=800mV	γ L8	Input: DLY ₁ IN = –400mV S1IN = S2IN = 1000mV Conditions: Same as γ Typ. Calculations: WB-G/ γ Typ.	1.13	1.2	1.25	—
	C- γ CONT=0V Gch-WB=100mV	γ L1	Input: DLY ₁ IN = –50mV S1IN = S2IN = 125mV (Others same as γ L8)	0.36	0.4	0.44	—
	C- γ CONT=1.8V Gch-WB=400mV	γ M4	Input: DLY ₁ IN = –200mV S1IN = S2IN = 500mV Conditions: C γ CONT = 1.8V Calculations: WB-G/ γ Typ.	0.9	1	1.1	—
	C- γ CONT=1.8V Gch-WB=800mV	γ M8	Input: DLY ₁ IN = –400mV S1IN = S2IN = 1000mV (Others same as γ M4)	1.13	1.2	1.25	—
	C- γ CONT=1.8V Gch-WB=100mV	γ M1	Input: DLY ₁ IN = –50mV S1IN = S2IN = 125mV (Others same as γ M4)	0.45	0.5	0.55	—
	C- γ CONT=5V Gch-WB=400mV	γ H4	Input: DLY ₁ IN = –200mV S1IN = S2IN = 500mV Conditions: C γ CONT = 1.8V Calculations: WB-G/ γ Typ.	0.9	1	1.1	—
	C- γ CONT=5V Gch-WB=800mV	γ H8	Input: DLY ₁ IN = –400mV S1IN = S2IN = 1000mV (Others same as γ H4)	1.13	1.2	1.25	—
	C- γ CONT=5V Gch-WB=100mV	γ H1	Input: DLY ₁ IN = –50mV S1IN = S2IN = 125mV (Others same as γ H4)	0.26	0.3	0.35	—

	Item	Symbol	Conditions	Min.	Typ.	Max.	Unit
Y γ	Y γ 1.0 (Typ.)	Y γ T	Input: Y _{HIN} = 220mV Calculations: DLY _{HOUT}	-440	-400	-360	mV
	Y γ 2.0/Y γ 1.0	Y γ 2.0	Input: Y _{HIN} = 440mV Calculations: DLY _{HOUT} /Y γ T	1.23	1.37	1.51	—
	Y γ 0.5/Y γ 1.0	Y γ 0.5	Input: Y _{HIN} = 110mV Calculations: DLY _{HOUT} /Y γ T	0.59	0.66	0.73	—
	Y γ 0.5 (Max.)/ Y γ 1.0	Y γ H	Input: Y _{HIN} = 110mV Conditions: Y γ CONT = 1.8V Calculations: DLY _{HOUT} /Y γ T	0.64	0.71	0.78	—
	Y γ 0.5 (Min.)/ Y γ 1.0	Y γ L	Input: Y _{HIN} = 110mV Conditions: Y γ CONT = 5V Calculations: DLY _{HOUT} /Y γ T	0.54	0.6	0.66	—
TP	TP (YH)	TPY	Input: Y _{HIN} = 220mV Conditions: DLY _{HGAIN} = 1.8V Calculations: TP/DLY _{HOUT}	-5	-4	-3	dB
	TP (DLY _H)	TPDY	Input: DLY _{HIN} = Y γ T \times 0.7 Conditions: Same as TPY Calculations: TP/-DLY _{HOUT} Note 7)	-5	-4	-3	dB
	TP (GWBS)	TPG	Input: S1IN = S2IN = 500mV DLY1IN = 200mV Conditions: Y1GAIN = 1.8V Calculations: TP/WB-G	-2	0	2	dB
Y _H AMP	Min. Gain	YLG	Input: Y _{HIN} = 220mV DLY _{HIN} = - [Y γ T \times -3.5dB] Conditions: DLY _{HGAIN} = 1.8V Calculations: TP is tested to check that the signal level is below 0mV in relation to black level. Note 8)	—	—	3.5	dB
	Max. Gain	YHG	Input: Y _{HIN} = 220mV DLY _{HIN} = - [Y γ T \times -12dB] Conditions: DLY _{HGAIN} = 5V Calculations: TP _{TP} is tested to check that the signal level is over 0mV in relation to black level. Note 8)	12	—	—	dB
Chroma level Max./Min.		GCL	Input: DLC1IN = 200mV Conditions: 1. WB-G is tested when C-level = 5V and taken as GC-level Min. 2. WB-G is tested when C-level = 1.8V and taken as GC-level Max. (Both 1 and 2 test at ID-H.) Calculations: GC-level Max. / GC-level Min.	1.55	1.65	1.75	—
WB DC		WDDC	Test: WB-DC	1.4	1.6	2	V

Item		Symbol	Conditions	Min.	Typ.	Max.	Unit
YL Note 5)	Y _L OUT/ R _γ OUT	Y _L R	Input: S ₁ IN = 150mV S ₂ IN = 450mV Conditions: C-γ CONT = WB DC = C-Slice = C-level = 5V RCONT = 4.6V BCONT = 2.5V BGAIN = 1.8V (ID = L) Calculations: Y _L OUT/WB-R	0.27	0.3	0.34	—
	Y _L OUT/ B _γ OUT	Y _L B	Input: S ₁ IN = 200mV S ₂ IN = 160mV DLC ₁ IN = 220mV Conditions: C-γ CONT = WB DC = C-Slice = C-level = 5V RCONT = 2.5V BCONT = 4.6V (ID = L) Calculations: Y _L OUT/WB-B	0.08	0.1	0.12	—
	Y _L OUT/ G _γ OUT	Y _L G	Input: S ₁ IN = 830mV S ₂ IN = 660mV DLC ₁ IN = -230mV Conditions: WB-DC = C-level = 5V RCONT = BCONT = 2.5V Calculations: Y _L OUT/WB-G	0.54	0.6	0.66	—
Y _H OUT1 (OH mode)		Y _H 1Z	Input: Y _H IN = 220mV Calculations: Y _H OUT1 is tested.	900	1000	1100	mV
Y _H OUT1 1H/0H		Y _H 1O	Input: DLY _H IN = - (Y _γ T × -4dB) Conditions: DLY _H GAIN = 1.8V Calculations: Y _H OUT1/Y _H 1Z Note 8)	-1	0	1	dB
Y _H OUT2 (0H) /Y _H OUT1		Y _H 2Z	Input: Y _H IN = 220mV Calculations: Y _H OUT2/Y _H 1Z	-1	0	1	dB
Y _H OUT2 (1H) /Y _H OUT1		Y _H 2O	Input: Y _H IN = 220mV Conditions: DLY _H GAIN = 1.8V Calculations: Y _H OUT2/Y _H OUT2Typ. Y _H OUT2Typ. is Y _H OUT2 output tested at Y _H 2Z.	-6.5	-6	-5.5	dB
VAP Typ. Note 9)		VAPT	Input: S ₁ IN = S ₂ IN = 125mV Conditions: VAP GAIN = 1.8V VAP Slice = 1.8V Y ₂ GAIN = 1.8V Calculations: VAP OUT is tested.	-250	-200	-150	mV
VAP Slice Note 9)		VS	Input: S ₁ IN = S ₂ IN = 1000mV Conditions: Y ₂ GAIN = 1.8V 1. VAP OUT is tested when VAP Slice=1.8V and taken as S _{Min} . 2. VAP OUT is tested when VAP Slice=5V and taken as S _{Max} . Calculations: S _{Max} .-S _{Min} . Note 10)	256	320	384	mV

Item		Symbol	Conditions	Min.	Typ.	Max.	Unit
DLY ₁ gain Note 11)	Min.	DY ₁ L	Input: S ₁ IN = S ₂ IN = 500mV DLY ₁ IN = -200mV Conditions: VAP GAIN = VAP Slice = Y ₁ GAIN = 1.8V Calculations: VAP-OUT is tested to check that the signal level is over 0mV in relation to black level.	—	—	0	dB
	Max.	DY ₁ H	Input: S ₁ IN = S ₂ IN = 500mV DLY ₁ IN = -110mV Conditions: VAP GAIN = VAP Slice = 1.8V Y ₁ GAIN = 5V Calculations: VAP-OUT is tested to check that the signal level is below 0mV in relation to black level.	5	—	—	dB
DLY ₂ gain Note 11)	Min.	DY ₂ L	Input: S ₁ IN = S ₂ IN = -167mV DLY ₂ IN = -66.7mV Conditions: VAP GAIN = VAP Slice = Y ₁ GAIN = Y ₂ GAIN = 1.8V Calculations: VAP-OUT is tested to check that the signal level is over 0mV in relation to black level.	—	—	0	dB
	Max.	DY ₂ H	Input: S ₁ IN = S ₂ IN = -167mV DLY ₂ IN = -37.5mV Conditions: Y ₂ GAIN = 5V (Others same as DY ₂ L) Calculations: VAP-OUT is tested to check that the signal level is below 0mV in relation to black level.	5	—	—	dB
CS Note 12)	VCS Typ.	VCST	Input: S ₁ IN = S ₂ IN = 167mV Conditions: Y ₁ GAIN = Y ₂ GAIN = 1.8V CS GAIN = 5V Calculations: CS OUT is tested.	90	120	150	mV
	VCS Min.	VCSL	Conditions: CS GAIN = 0V (Others same as VCST) Calculations: CS OUT/VCST	—	0	0.05	—
	VCS Max.	VCSH	Conditions: CS GAIN = 1.8V (Others same as VCSL)	4.4	—	—	—
	VCS Typ.	CST	Input: CS-IN = 500mV	440	465	490	mV

Note 1) For pins without specific instructions regarding input, feed the DC value shown on the Test Circuit. Calculations are mentioned utilizing the pin name or the electrical characteristics symbols. Otherwise, for exceptional notations explanatory notes, are given with every case.

Note 2) In this item, the gain of DLC₁ amplifier exclusively is calculated. CG is the gain of the system from DLC₁ IN to WB-R from which DLC₁ GC amplifier gain has been excluded.

—CG calculating method—

In the actual calculation, the system on C₀ side is utilized.

Input: S₁IN = -62.5mV S₂IN = 62.5mV

Condition: Same as DLC₁H

Calculations: CG = 20log (WB-R/DLC₀OUT)

Note 3) Chroma matrix operations

$R = 2 [C_R + \alpha Y]$ α : Control with RMTX (Preset 0.167)

$G = Y - (C_R + C_B)$

$B = 2 [C_B + \beta (Y - C)]$ β : Control with BMTX (Preset 0.22)

Note 4) With the typical gain taken when R CONT is at 4V, compare with the gain during Max. and Min. The same for B CONT.

Note 5) Adjustment and testing is performed so that signals are output only for each of R, G, B channels respectively.

Note 6) Comparison with B-Y OUT when R-Y HUE = 0V (HUE OFF).

The same for B-Y HUE.

Note 7) The compensation of difference in gain of Y_{H0} and Y_{H1} is as follows.

1) At DLY_H GAIN = 1.8V, DLY_H amplifier gain is 3dB.

2) Test DLY_H OUT (tested at Y_{rT}) when Y_H IN = 220mV signal is input.

3) The difference in gain between Y_{H0} and Y_{H1} is compensated by inputting the signal as -3dB to DLY_H IN.

Note 8) The amplifier input is varied and the gain confirmed.

Note 9) VAP (Vertical Aperture Compensation)

Note 10) Dark slice variable volume. (Output level difference between the value slice volume at Max. and slice volume at Min.)

Note 11) Utilizing V-APCN 2H mode, DLY₁ amplifier exclusive gain is obtained through operations. However, as the amplifier gain cannot be tested directly, only the upper and lower limits of the gain control are checked according to the following method.

(a) Lower limit check

S₁ IN = S₂ IN = 500mV (At that time KNEE circuit input turns to 200mV)

DLY₁ IN = -200mV (For others refer to the conditions chart)

In this condition, if we have VAP OUT ≥ 0, this indicates that DLY₁ amplifier is below 0dB.

(b) Upper limit check

S₁ IN = S₂ IN = 500mV

DLY₁ IN = -110mV (in (a) the -5dB of -200mV)

In this condition, if we have VAP OUT ≤ 0, this indicates that DLY₁ amplifier is above 5dB.

Note 12) CS (Chroma Suppress)

Timing Chart for Testing

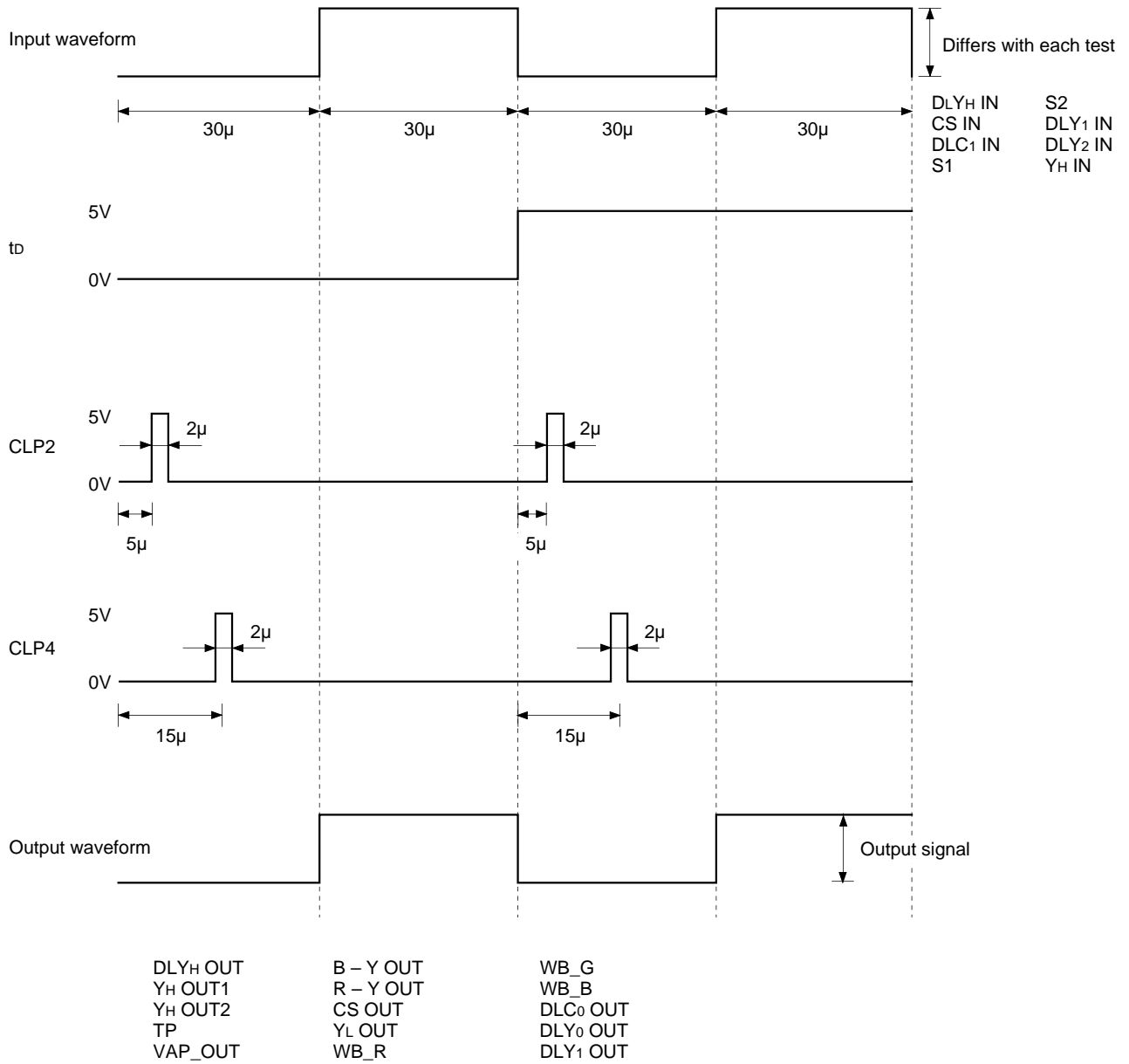

Test Circuit (Typ. setting)

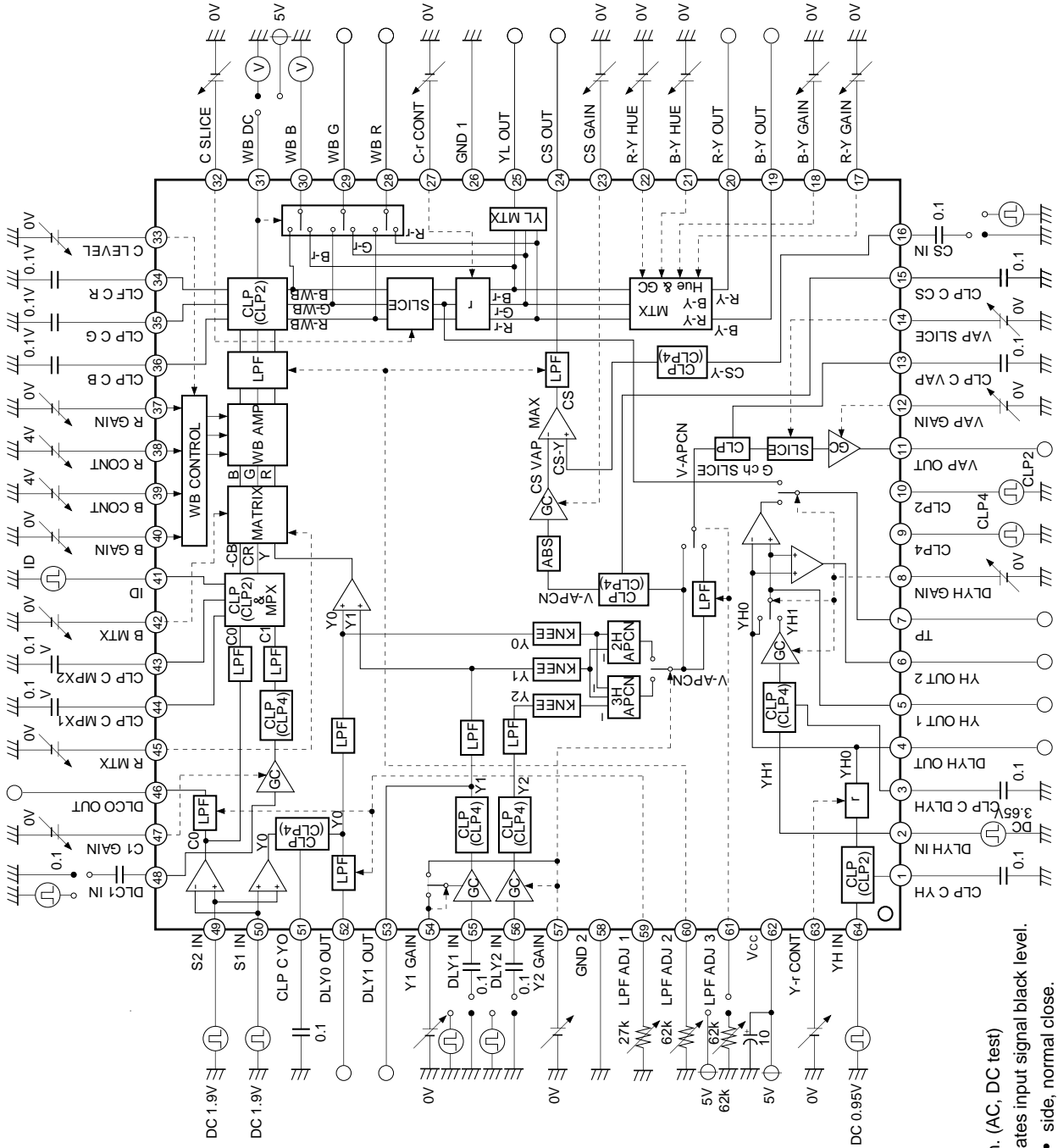

- Note 1) μF is unit of capacitor
- Note 2) $\text{---}\circ\text{---}$ indicates testing pin. (AC, DC test)
- Note 3) Input pin DC value indicates input signal black level.
- Note 4) $\text{---}\circ\text{---}$ indicate relay, \bullet side, normal close.

Standard Control Characteristics ($V_{CC} = 5V$, $T_a = 25^\circ C$)

C1 GAIN control characteristics

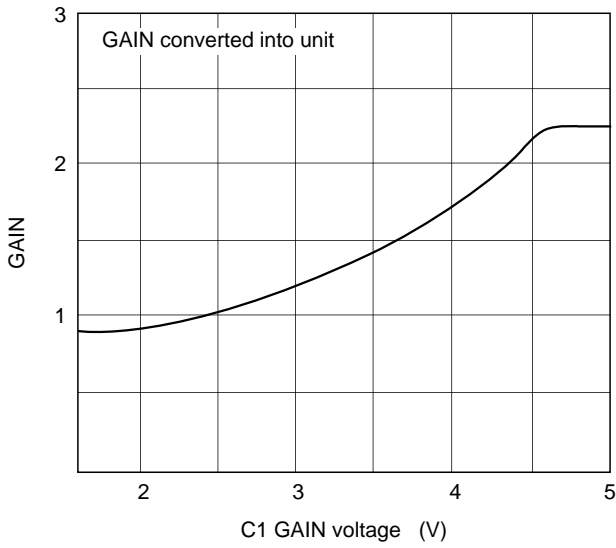

R-MTX coefficient

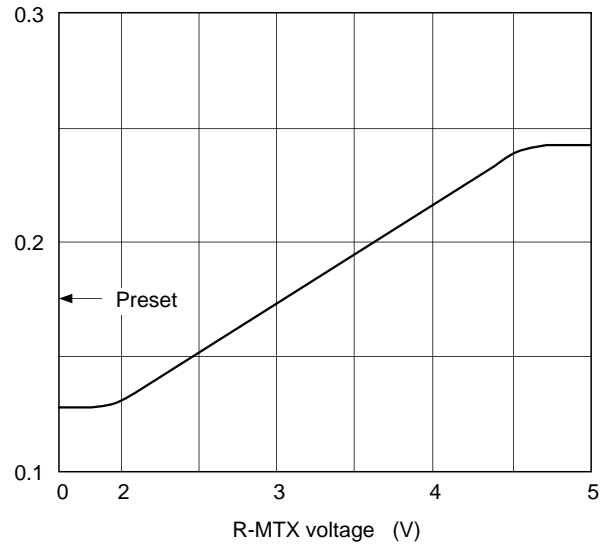

B-MTX coefficient

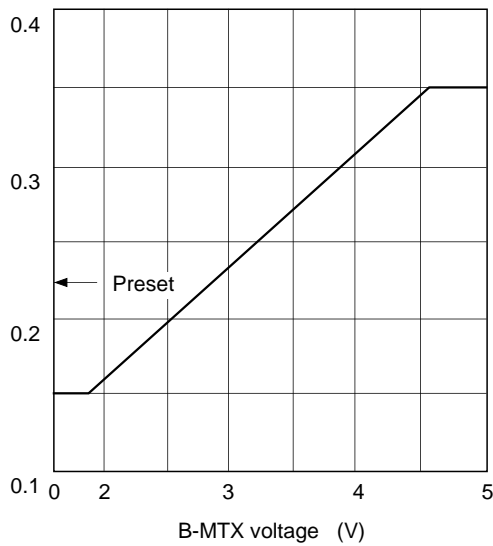

R GAIN control characteristics

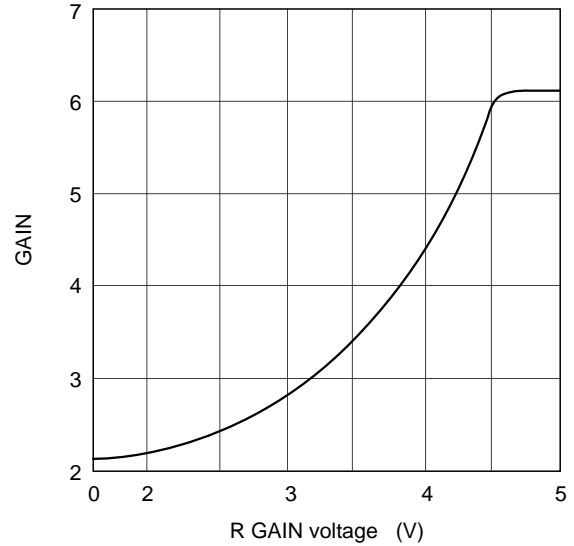

B GAIN control characteristics

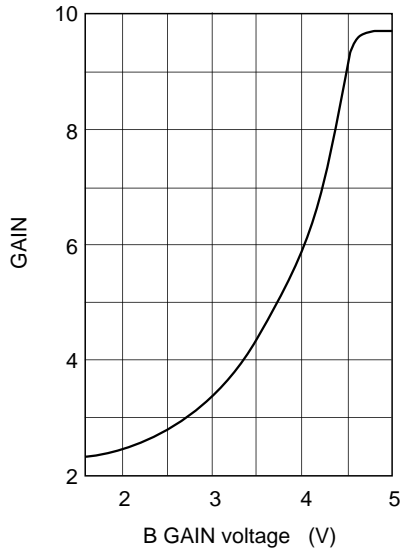

R/B CONT control characteristics

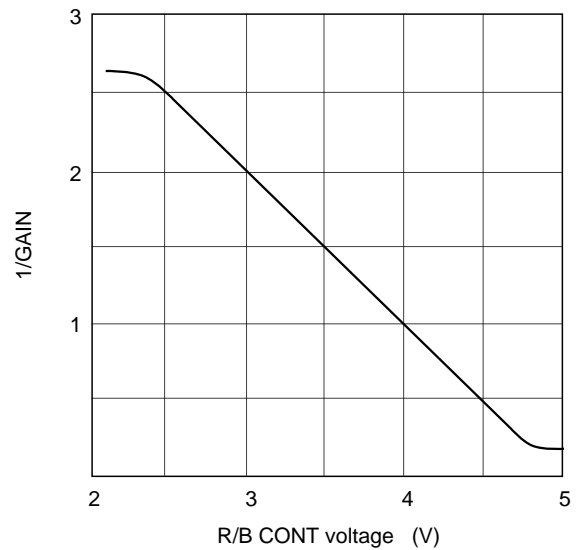

C-SLICE control characteristics

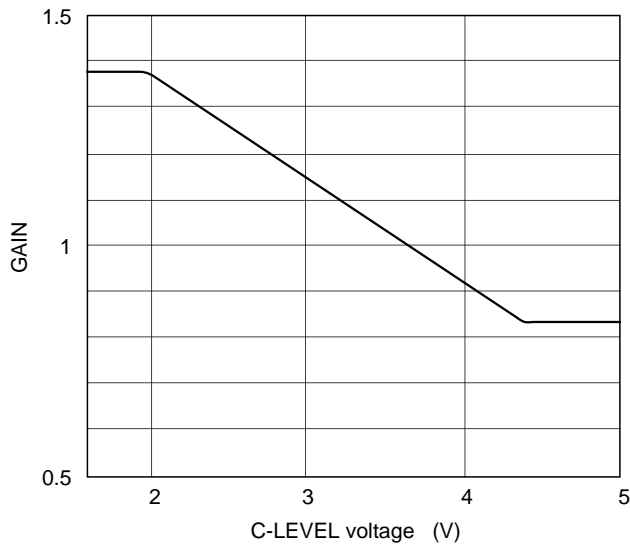

C-SLICE control characteristics

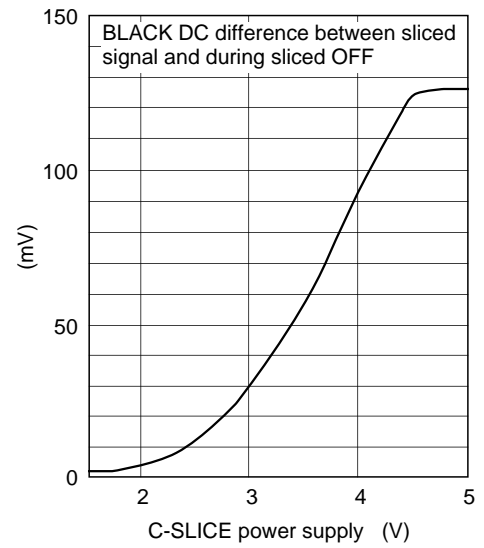

R-Y/B-Y GAIN control characteristics

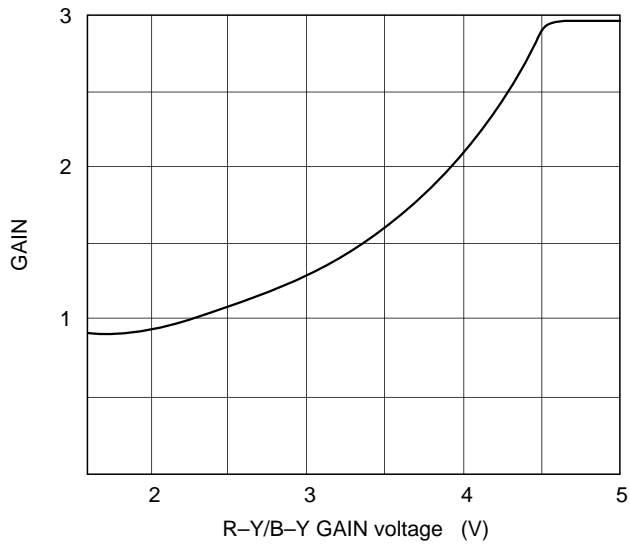

R-Y/B-Y HUE control characteristics

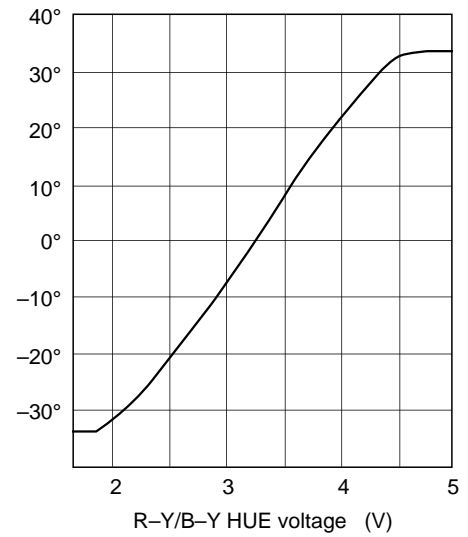

Y1/Y2 GAIN control characteristics

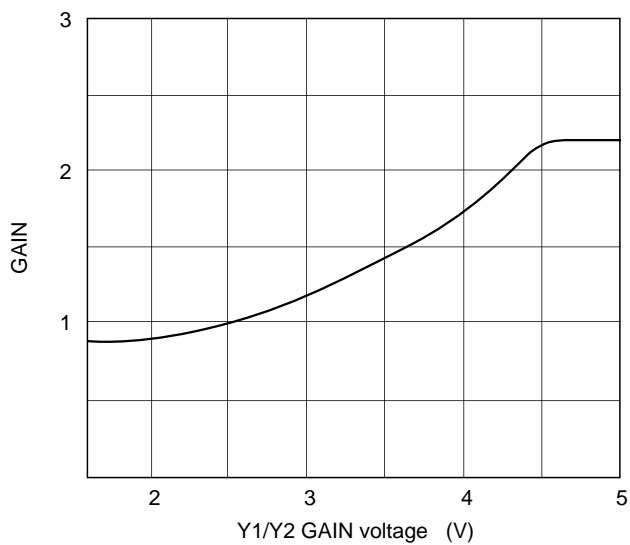

CS GAIN control characteristics

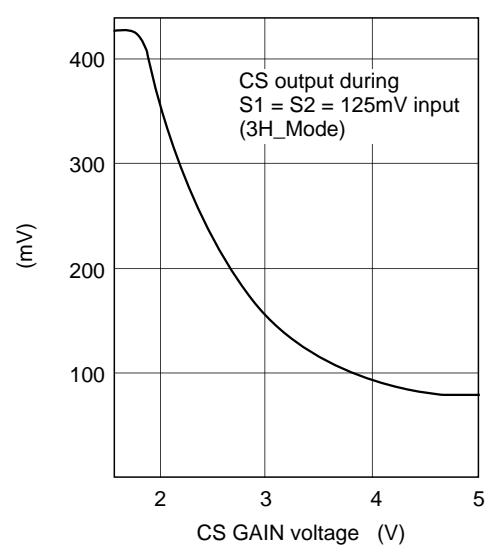

DLYH GAIN control characteristics

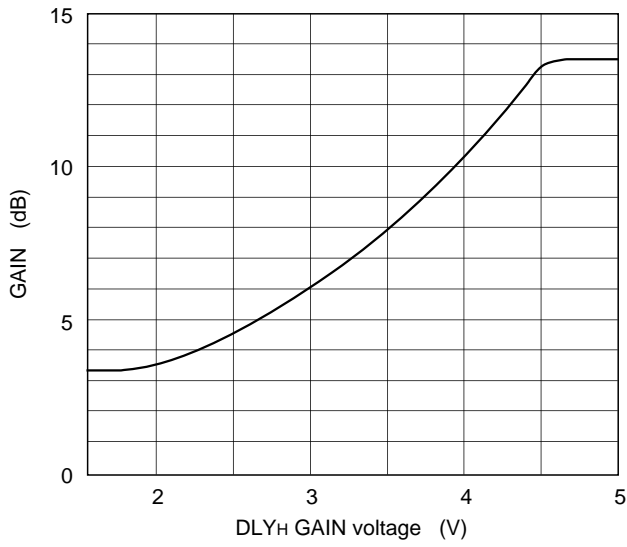

VAP control characteristics

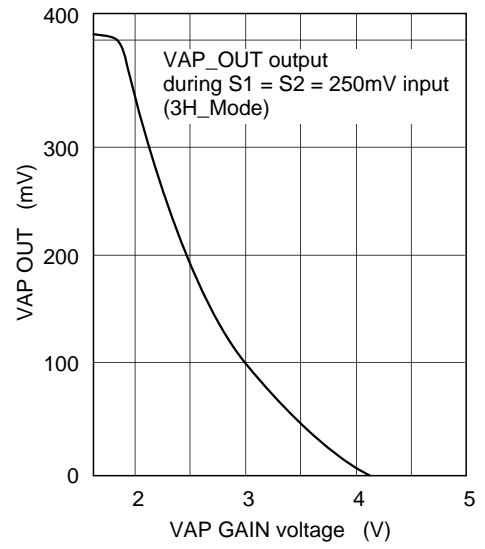

VAP SLICE control characteristics

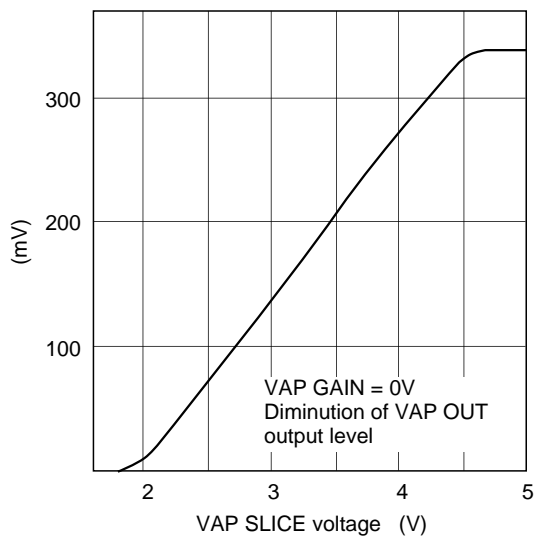

Standard Design Data

Chroma γ curve (standardize)

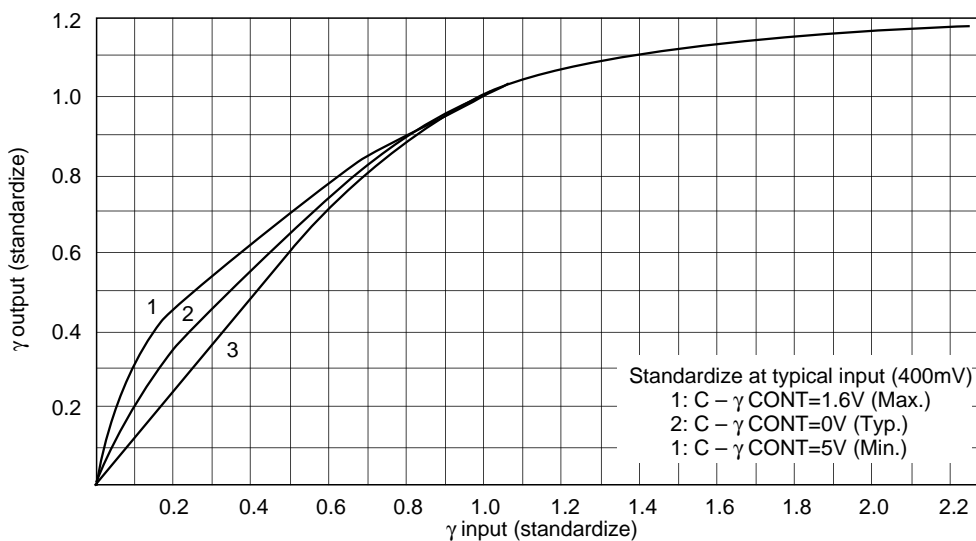

Y_H γ curve (standardize) (mV)

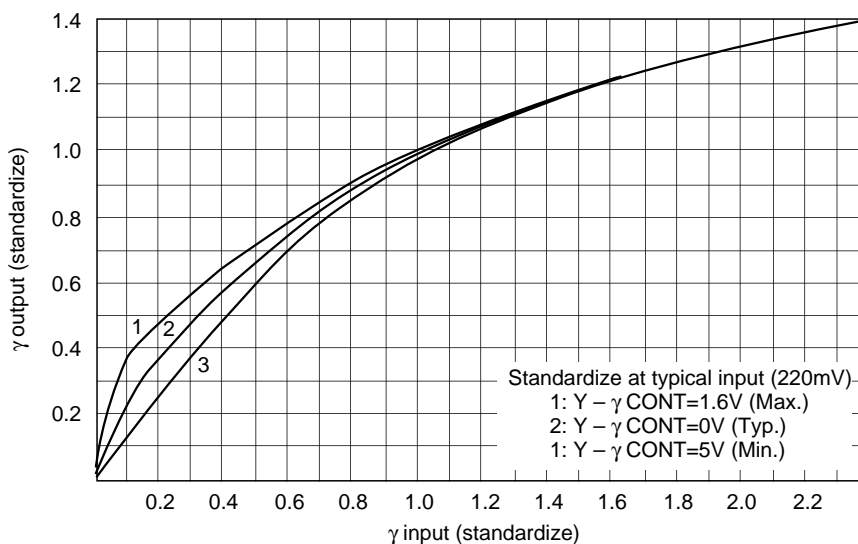

V-APCN Knee (standardize) (mV)

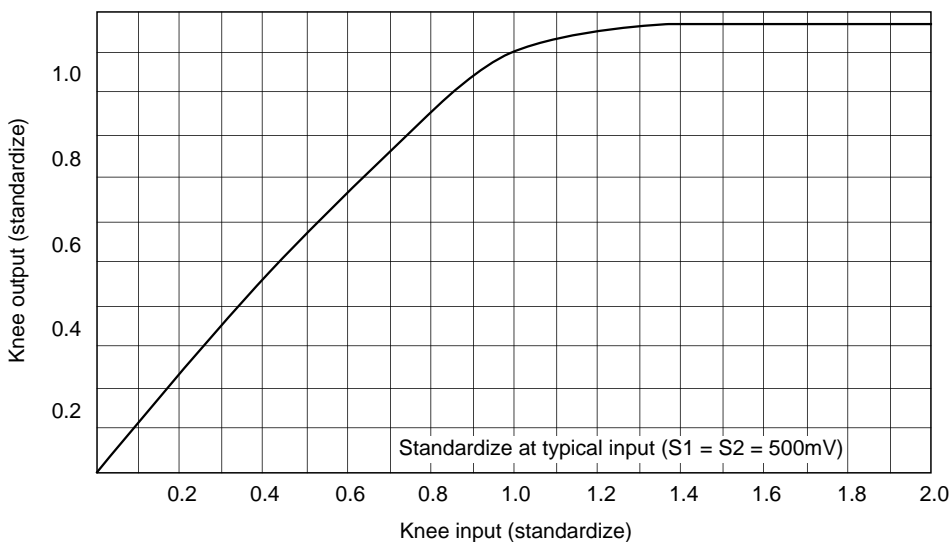

Pre-Filter Adjust characteristics

(S1, S2 → DL Y0 out
DL C0 out)

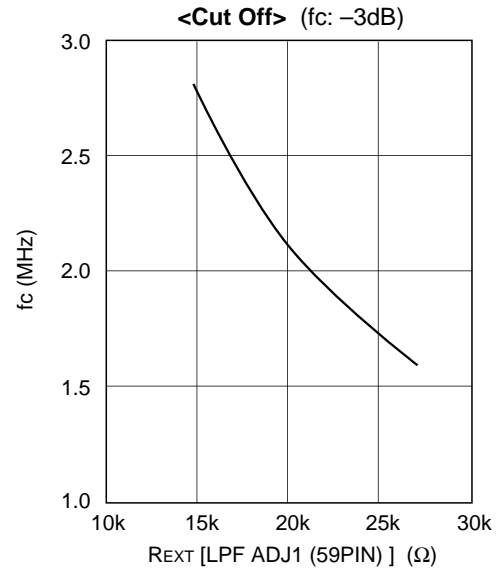
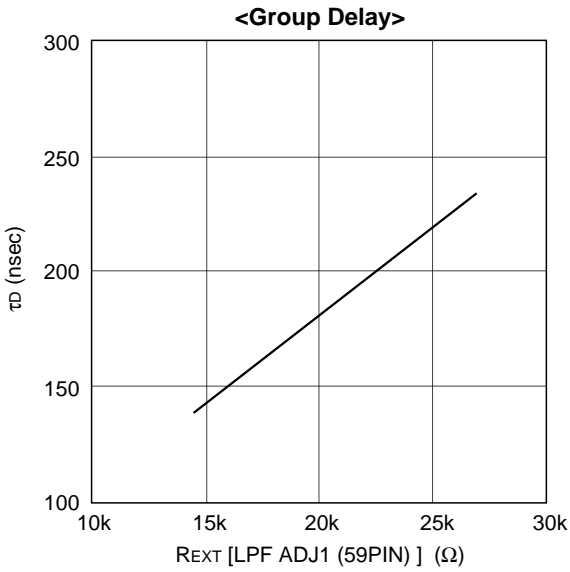

Chroma Adjust characteristics

(S1, S2 → R-Y out
B-Y out)

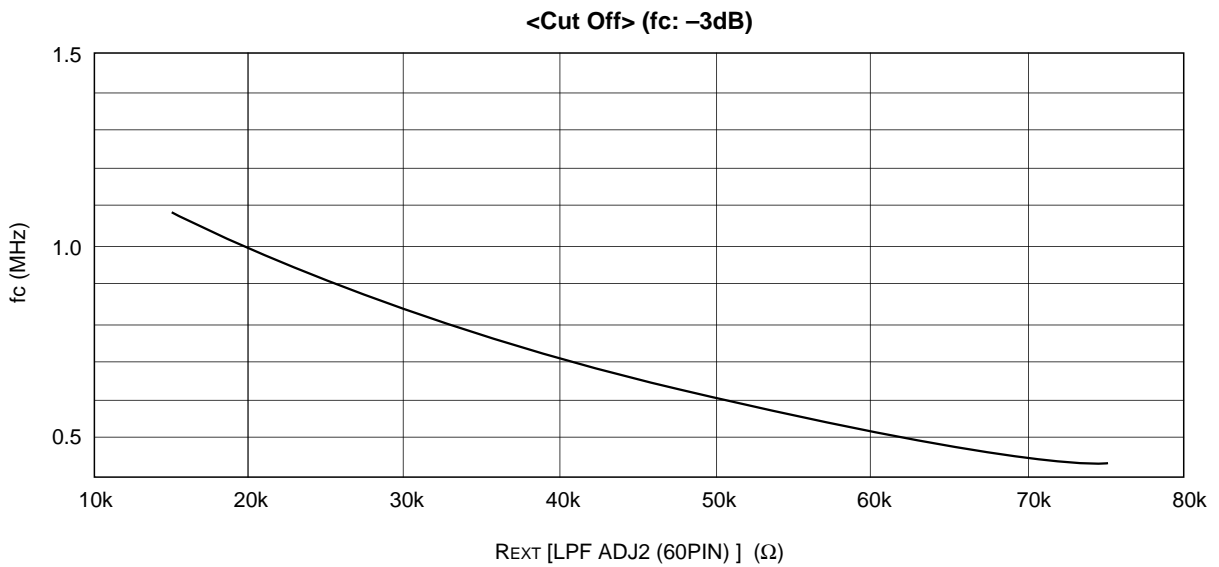
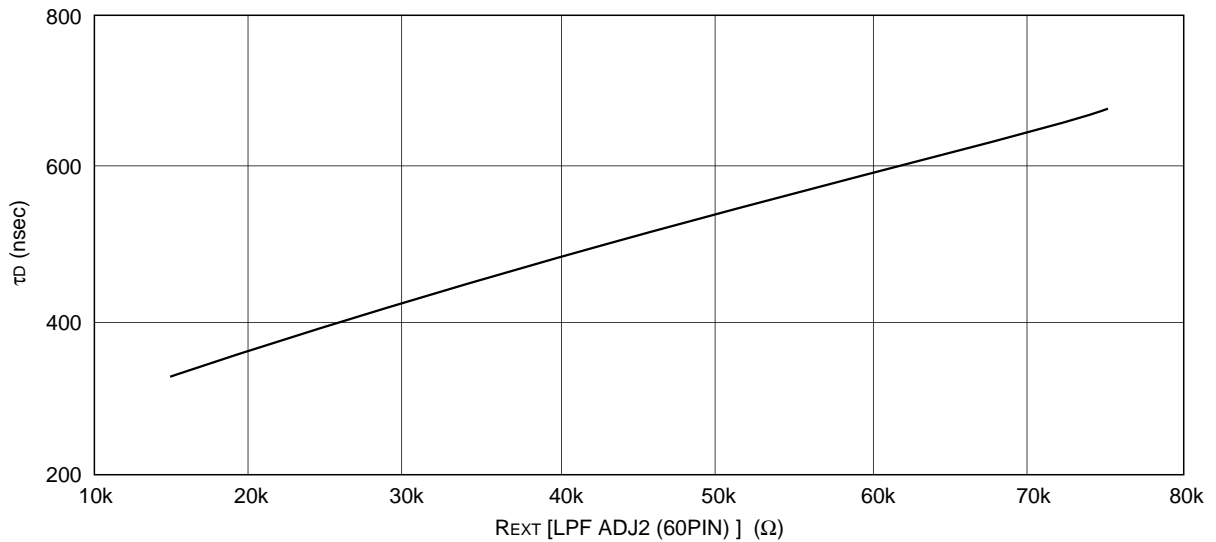

CS-VAP Adjust characteristics (S1, S2 → CS OUT)
<Group Delay>

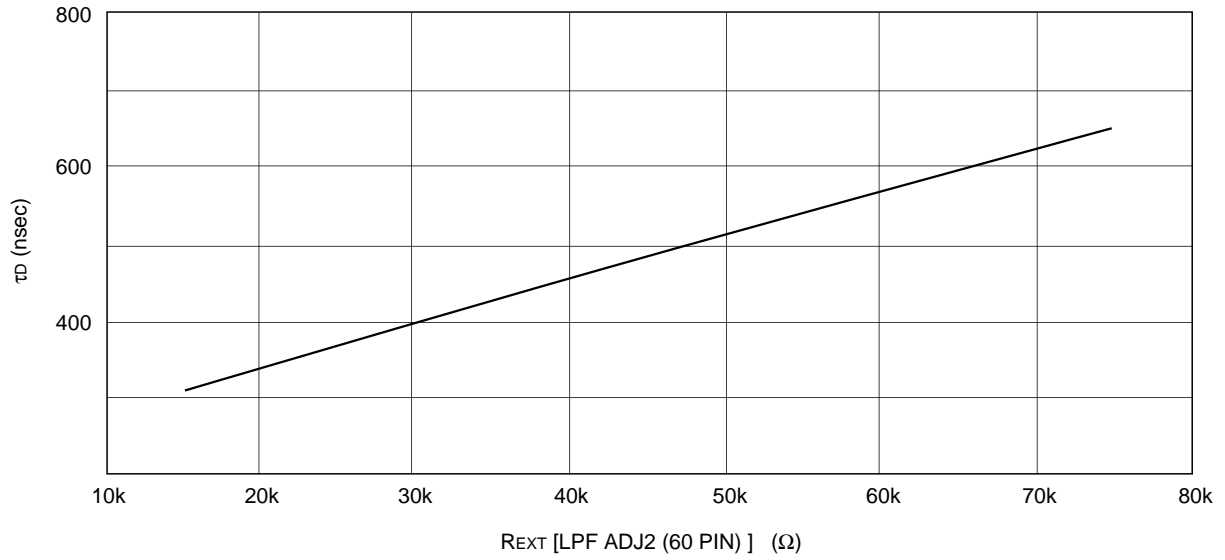

<Cut Off> (f_c : -3dB)

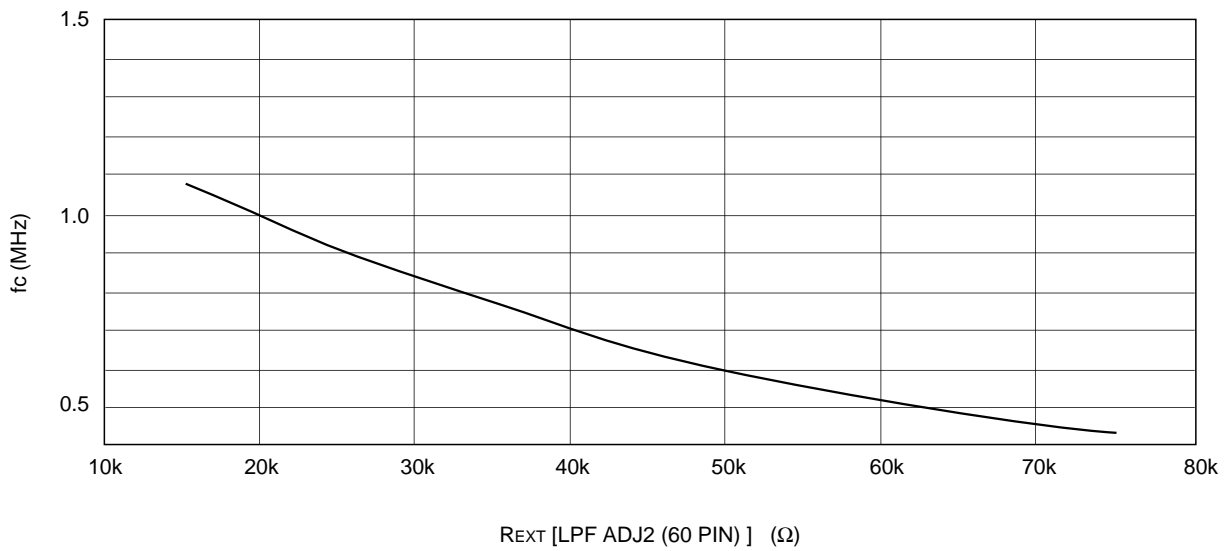

CS-Y LPF Adjust characteristics (CS IN → CS OUT)
<Group Delay>

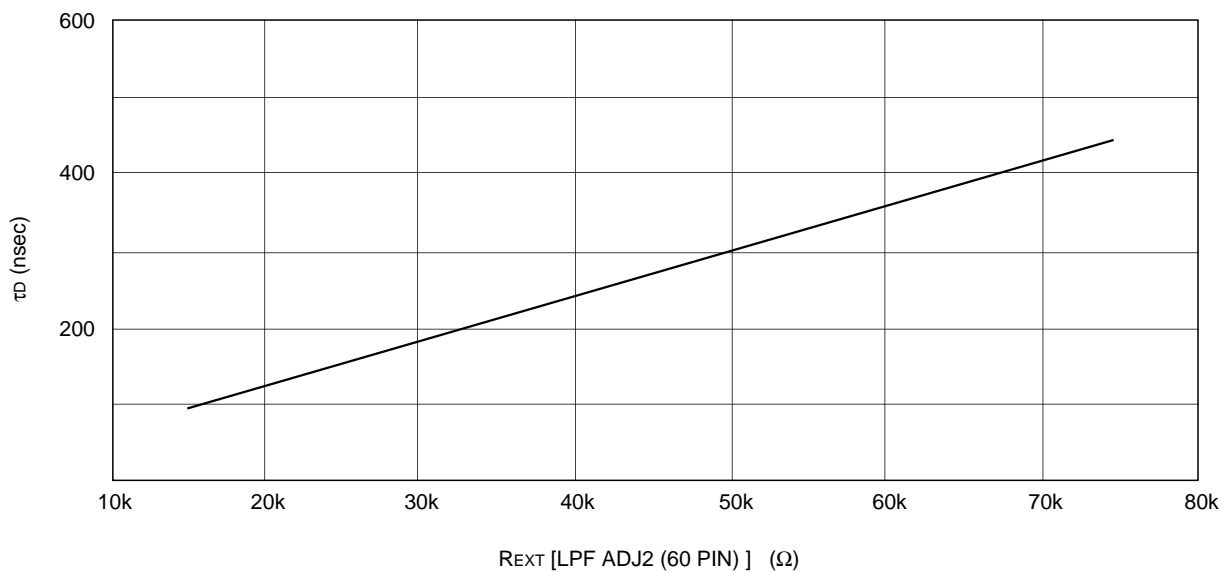

<Cut Off> (f_c: -3dB)

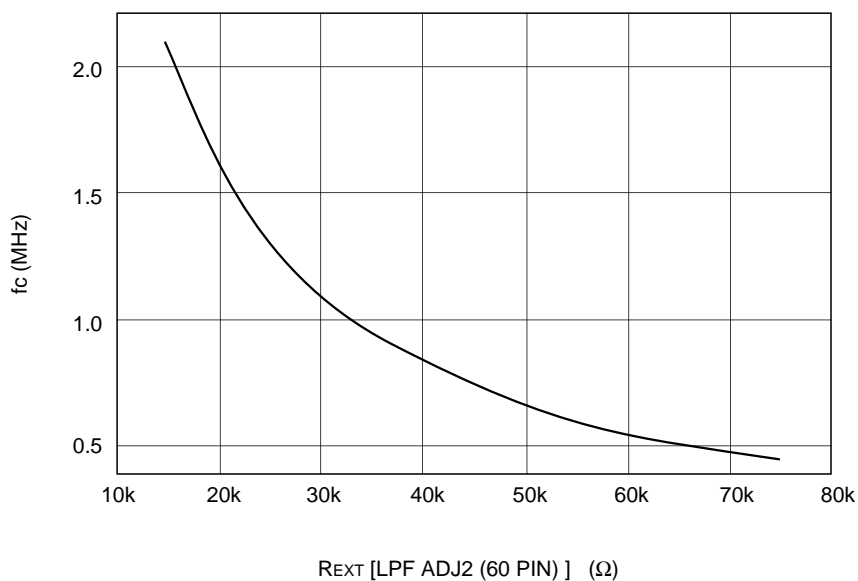

VAP LPF Adjust characteristics

VAP LPF Adjust characteristics (S1, S2 → VAP OUT)
 <Group Delay>

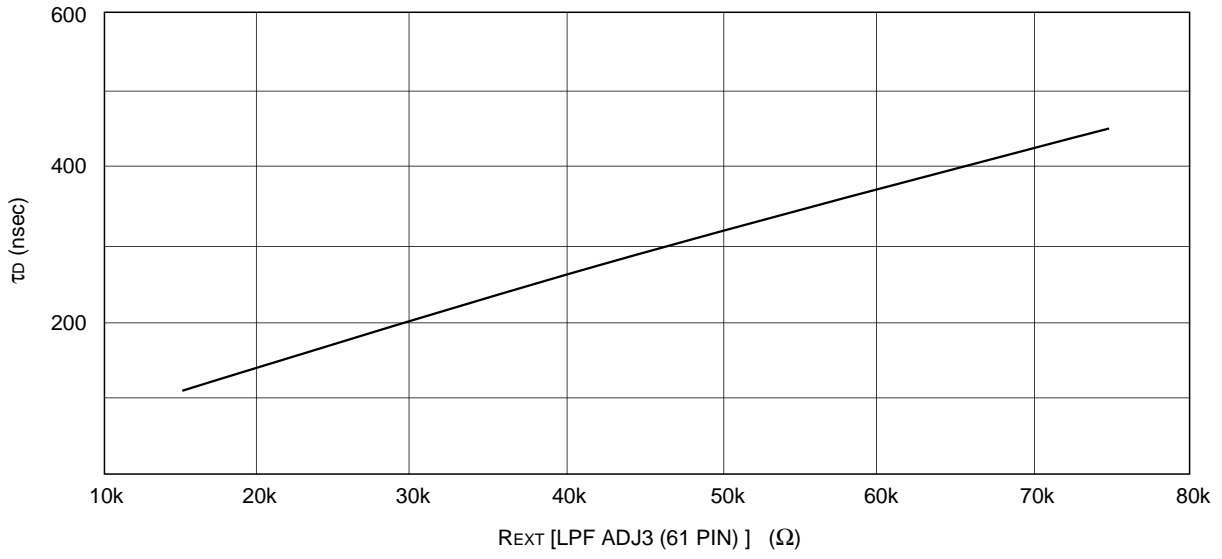

<Cut Off> (f_c : -3dB)

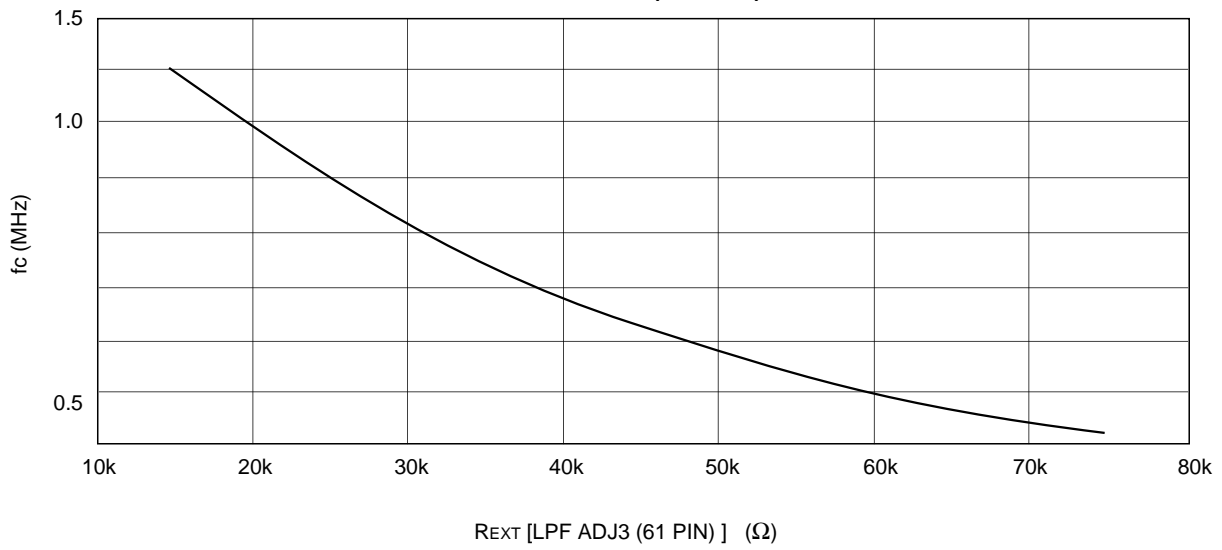

CXA Series System Diagram

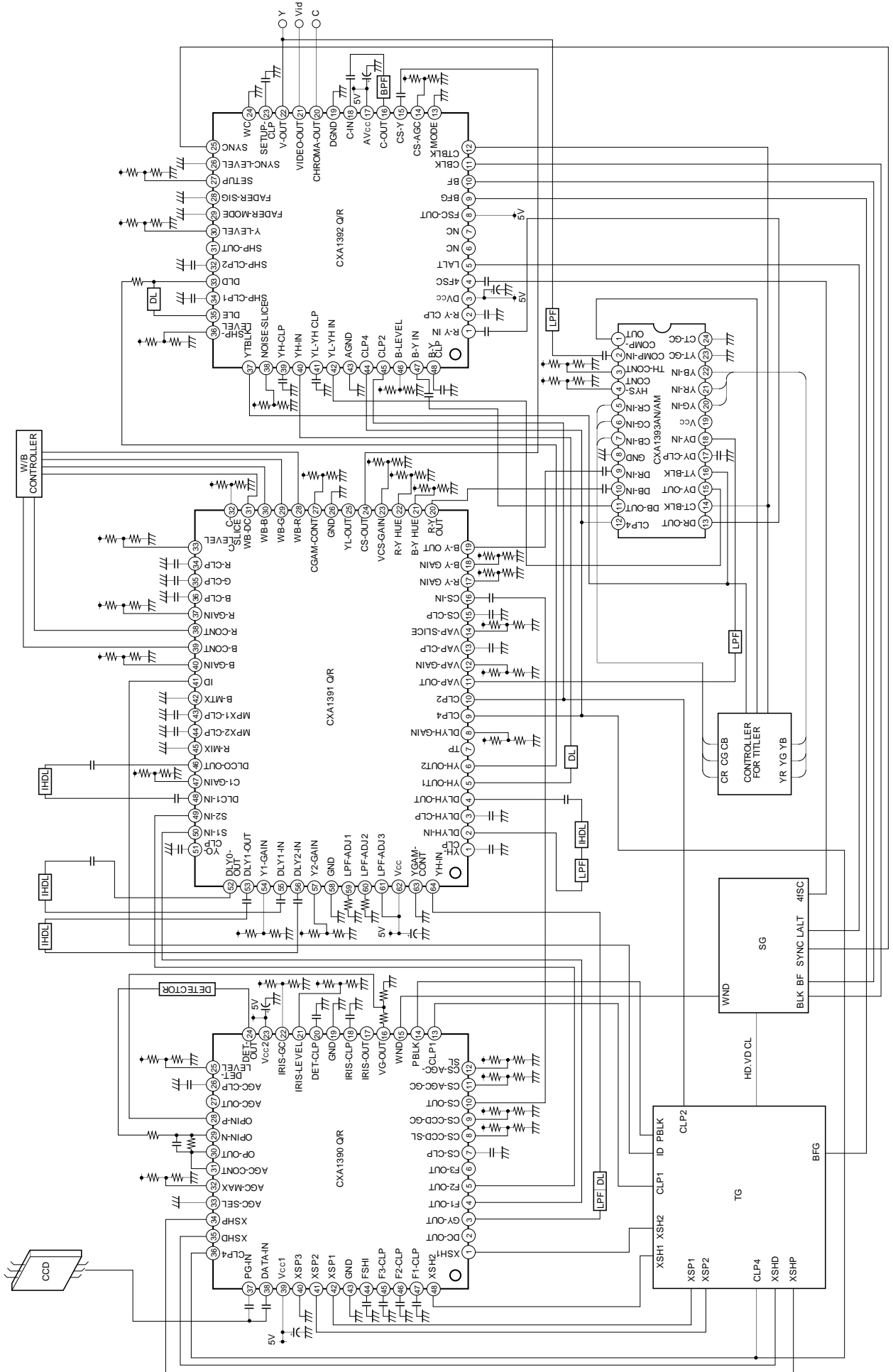

Package Outline

Unit: mm

CXA1391Q

64PIN QFP(PLASTIC)

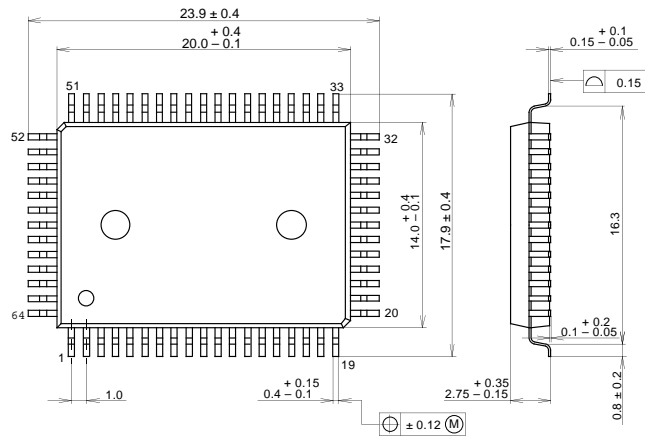

PACKAGE STRUCTURE

SONY CODE	QFP-64P-L01
EIAJ CODE	*QFP064-P-1420
JEDEC CODE	—————

PACKAGE MATERIAL	EPOXY RESIN
LEAD TREATMENT	SOLDER/PALLADIUM PLATING
LEAD MATERIAL	COPPER /42 ALLOY
PACKAGE WEIGHT	1.5g

CXA1391R

64PIN LQFP (PLASTIC)

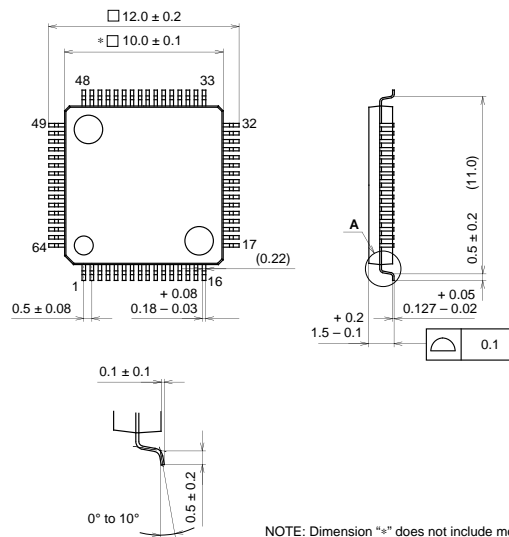

DETAIL A

NOTE: Dimension "*" does not include mold protrusion.

PACKAGE STRUCTURE

SONY CODE	LQFP-64P-L01
EIAJ CODE	*QFP064-P-1010-A
JEDEC CODE	—————

PACKAGE MATERIAL	EPOXY / PHENOL RESIN
LEAD TREATMENT	SOLDER PLATING
LEAD MATERIAL	42 ALLOY
PACKAGE WEIGHT	0.3g