

US Audio Multiplexing Decoder

Description

The CXA2104S is an IC designed as a decoder for the Zenith TV Multi-channel System and also corresponds with I²C BUS. Functions include stereo demodulation, SAP (Separate Audio Program) demodulation, dbx noise reduction. Various kinds of filters are built in while adjustment and mode control are all executed through I²C BUS.

Features

- Adjustment free of VCO and filter.
- Audio multiplexing decoder and dbx noise reduction decoder are all included in a single chip. Almost any sort of signal processing is possible through this IC.
- All adjustments are possible through I²C BUS to allow for automatic adjustment.
- Various built-in filter circuits greatly reduce external parts.
- There is an additional SAP output.

Standard I/O Level

- Input level
 COMPIN (Pin 11) 100mVrms
 245mVrms (Selected by INSW)
- Output level
 TVOUT-L/R (Pins 2 and 1) 490mVrms

Pin Configuration (Top View)

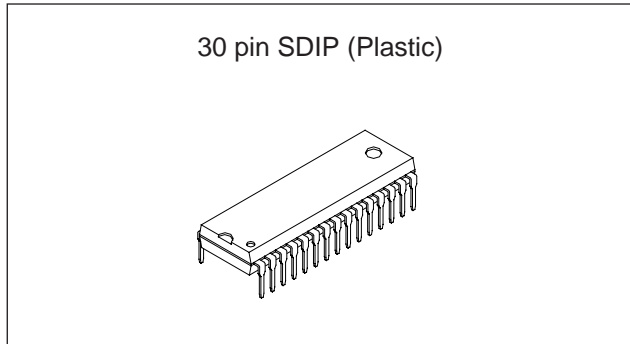
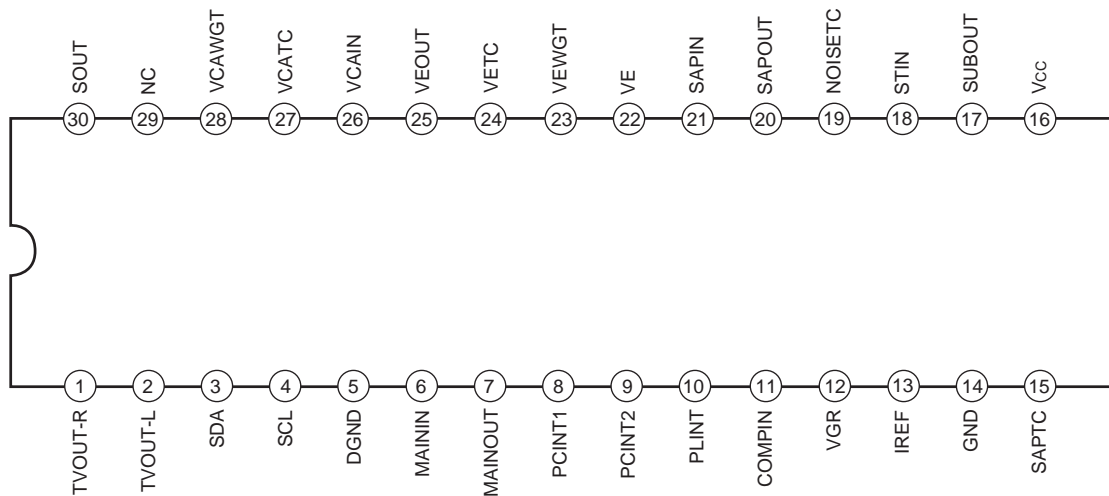

Absolute Maximum Ratings (Ta = 25°C)

• Supply voltage	V _{CC}	11	V
• Operating temperature	T _{opr}	-20 to +75	°C
• Storage temperature	T _{stg}	-65 to +150	°C
• Allowable power dissipation	P _D	1.35	W

Range of Operating Supply Voltage

9 ± 0.5 V

Applications

TV, VCR and other decoding systems for US audio multiplexing TV broadcasting

Structure

Bipolar silicon monolithic IC

* A license of the dbx-TV noise reduction system is required for the use of this device.

Sony reserves the right to change products and specifications without prior notice. This information does not convey any license by any implication or otherwise under any patents or other right. Application circuits shown, if any, are typical examples illustrating the operation of the devices. Sony cannot assume responsibility for any problems arising out of the use of these circuits.

Block Diagram

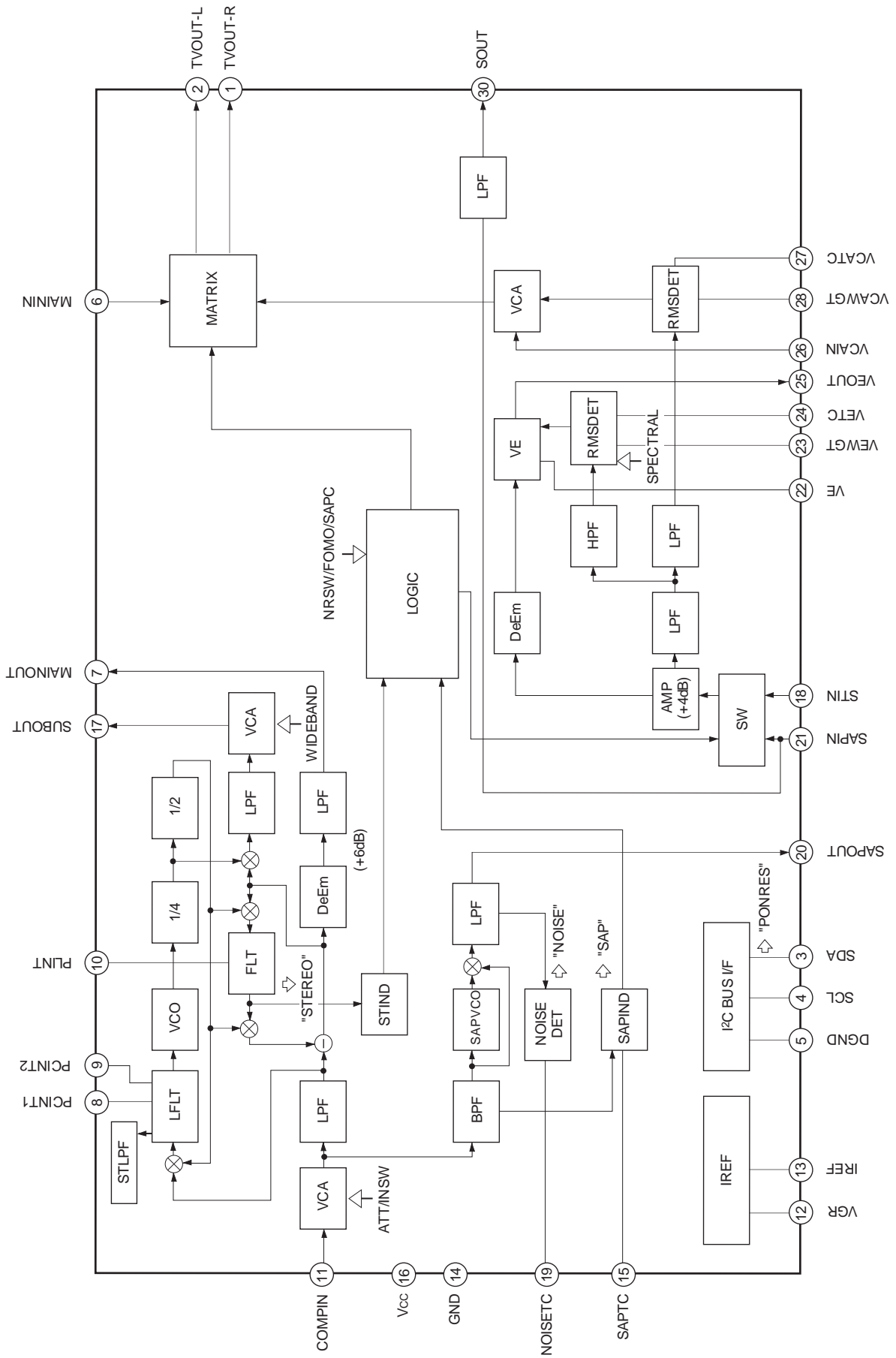

Pin Description

(Ta = 25°C, Vcc = 9V)

Pin No.	Symbol	Pin voltage	Equivalent circuit	Description
1	TVOUT-R	4.0V		TVOUT right channel output pin.
2	TVOUT-L	4.0V		TVOUT left channel output pin.
3	SDA	—		Serial data I/O pin. $V_{IH} > 3.0V$ $V_{IL} < 1.5V$
4	SCL	—		Serial clock input pin. $V_{IH} > 3.0V$ $V_{IL} < 1.5V$
5	DGND	—		Digital block GND.
6	MAININ	4.0V		Input the (L + R) signal from MAINOUT (Pin 7).

Pin No.	Symbol	Pin voltage	Equivalent circuit	Description
7	MAINOUT	4.0V		(L + R) signal output pin.
8	PCINT1	4.0V		Stereo block PLL loop filter integrating pin.
9	PCINT2	4.0V		
10	PLINT	5.1V		Pilot cancel circuit loop filter integrating pin. (Connect a 1µF capacitor between this pin and GND.)

Pin No.	Symbol	Pin voltage	Equivalent circuit	Description
11	COMPIN	4.0V		Audio multiplexing signal input pin.
12	VGR	1.3V		Band gap reference output pin. (Connect a 10 μ F capacitor between this pin and GND.)
13	IREF	1.3V		Set the filter and VCO reference current. The reference current is adjusted with the BUS DATA based on the current which flows to this pin. (Connect a 62k Ω (\pm 1%) resistor between this pin and GND.)
14	GND	—		Analog block GND.
15	SAPTC	4.5V		Set the time constant for the SAP carrier detection circuit. (Connect a 4.7 μ F capacitor between this pin and GND.)

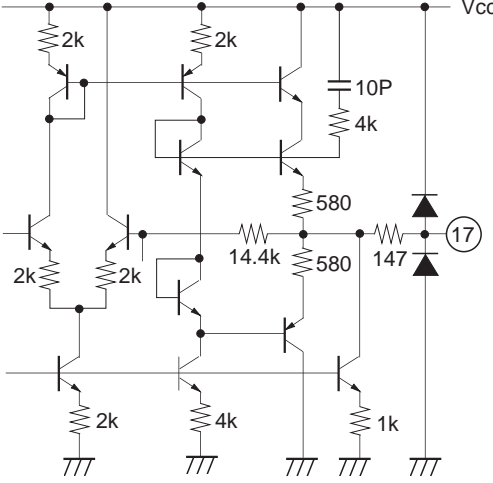
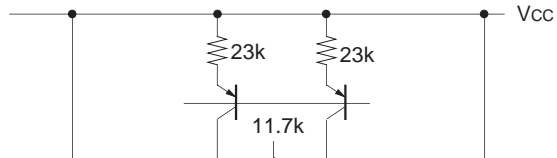
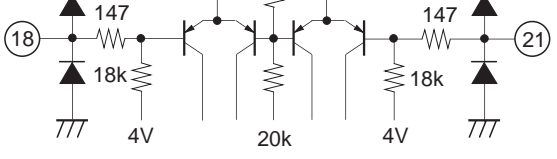
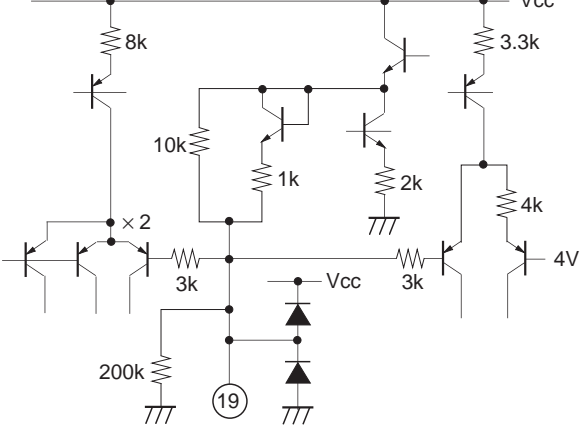
Pin No.	Symbol	Pin voltage	Equivalent circuit	Description
16	Vcc	—		Supply voltage pin.
17	SUBOUT	4.0V		(L-R) signal output pin.
18	STIN	4.0V		Input the (L-R) signal from SUBOUT (Pin 17).
21	SAPIN	4.0V		Input the (SAP) signal from SAPOUT (Pin 20).
19	NOISETC	3.0V		Set the time constant for the noise detection circuit. (Connect a 4.7µF capacitor between this pin and GND.)

Pin No.	Symbol	Pin voltage	Equivalent circuit	Description
20	SAPOUT	4.0V		SAP FM detector output pin.
22	VE	4.0V		Variable de-emphasis integrating pin. (Connect a 2700pF capacitor and a 3.3kΩ resistor in series between this pin and GND.)
23	VEWGT	4.0V		Weight the variable de-emphasis control effective value detection circuit. (Connect a 0.047µF capacitor and a 3kΩ resistor in series between this pin and GND.)
24	VETC	1.7V		Determine the restoration time constant of the variable de-emphasis control effective value detection circuit. (the specified restoration time constant can be obtained by connecting a 3.3µF capacitor between this pin and GND.)

Pin No.	Symbol	Pin voltage	Equivalent circuit	Description
25	VEOUT	4.0V		<p>Variable de-emphasis output pin. (Connect a 4.7μF non-polar capacitor between Pins 25 and 26.)</p>
26	VCAIN	4.0V		<p>VCA input pin. Input the variable de-emphasis output signal from Pin 25 via a coupling capacitor.</p>
27	VCATC	1.7V		<p>Determine the restoration time constant of the VCA control effective value detection circuit. (the specified restoration time constant can be obtained by connecting a 10μF capacitor between this pin and GND.)</p>
28	VCAWGT	4.0V		<p>Weight the VCA control effective value detection circuit. (Connect a 1μF capacitor and a 3.9kΩ resistor in series between this pin and GND.)</p>
29	NC	—		—

Pin No.	Symbol	Pin voltage	Equivalent circuit	Description
30	SOUT	4.0V		Additional SAP output pin.

Electrical Characteristics
COMPIN input level
(100% modulation level)

	INSW = 0	INSW = 1
Main (L + R) (Pre-Emphasis: OFF)	= 245mVrms	= 100mVrms
SUB (L - R) (dbx-TV: OFF)	= 490mVrms	= 200mVrms
Pilot	= 49mVrms	= 20mVrms
SAP Carrier	= 147mVrms	= 60mVrms

$f_H = 15.734\text{kHz}$

($T_a = 25^\circ\text{C}$, $V_{CC} = 9\text{V}$)

No.	Item	Signal	Mode	Input pin	Input signal	Measurement conditions	Filter	Output pin	Min.	Typ.	Max.	Unit
1	Current consumption	I _{cc}		—	No signal				22	32	42	mA
2	Main output level	V _{main}	MONO	11	Mono 1kHz 100% mod. Pre-em. ON			1/2	440	490	540	mVrms
3	Main de-emphasis frequency characteristic	FC _{deem}	MONO	11	Mono 5kHz 30% mod. Pre-em. ON	20 log (‘5k/‘1k)		1/2	-1.2	0	1.0	dB
4	Main LPF frequency characteristic	FC _{main}	MONO	11	Mono 12kHz 30% mod. Pre-em. ON	20 log (‘12k/‘1k)		1/2	-3.0	-1.0	1.0	dB
5	Main distortion	THD _m	MONO	11	Mono 1kHz 100% mod. Pre-em. ON		15kLPF	1/2	—	0.1	0.5	%
6	Main overload distortion	THD _{mmax}	MONO	11	Mono 1kHz 200% mod. Pre-em. ON		15kLPF	1/2	—	0.15	0.5	%
7	Main S/N	SN _{main}	MONO	11	Mono 1kHz, Pre-em. ON	20 log (‘100%/‘0%)	15kLPF	1/2	61	69	—	dB
8	Sub output level	V _{sub}	ST	11	SUB (L-R) 1kHz, 100% mod., NR OFF			17	150	190	230	mVrms
9	Sub LPF frequency characteristic	FC _{sub}	ST	11	SUB (L-R) 12kHz, 30% mod., NR OFF	20 log (‘12k/‘1k)		17	-3.0	-0.5	1.0	dB
10	Sub distortion	THD _{sub}	ST	11	SUB (L-R) 1kHz, 100% mod., NR OFF		15kLPF	17	—	0.1	1.0	%
11	Sub overload distortion	THD _{smax}	ST	11	SUB (L-R) 1kHz, 200% mod., NR OFF		15kLPF	17	—	0.2	2.0	%
12	Sub S/N	SN _{sub}	ST	11	SUB (L-R) 1kHz, NR OFF	20 log (‘100%/‘0%)	15kLPF	17	56	64	—	dB
13	ST → SAP Crosstalk	CT _{st}	SAP	11	SUB (L-R) 1kHz, 100% mod., NR ON, SAP Carrier (5f _H)	20 log (‘NRSW = 0/ ‘NRSW = 1)	1kLPPF	2	60	70	—	dB

No.	Item	Signal	Mode	Input pin	Input signal	Measurement conditions	Filter	Output pin	Min.	Typ.	Max.	Unit
14	Sub pilot leak	PCsub	ST	11	PILOT (fH) 0dB	0dB = 49mVrms	fH BPF	17	-	-42	-30	dB
15	Stereo ON level	THst	ST	11	Change PILOT (fH) Level	0dB = 49mVrms		BUS RETURN	-9.0	-6.0	-3.0	dB
16	Stereo ON/OFF hysteresis	HYst				20 log ('on level'/ 'off level')			2.0	6.0	10.0	dB
17	SAP output level	Vsap	SAP	11	SAP 1kHz 100% mod. NR OFF			20	150	190	230	mVrms
18	SAP LPF frequency characteristic	FCsap	SAP	11	SAP 10kHz 30% mod. NR OFF	20 log ('10k'/ '1k')		20	-3.0	0	2.5	dB
19	SAP distortion	THDsap	SAP	11	SAP 1kHz 100% mod. NR OFF		15kLPF	20	-	2.5	6.0	%
20	SAP S/N	SNsap	SAP	11	SAP 1kHz, NR OFF	20 log ('100%'/ '0%')	15kLPF	20	46	55	-	dB
21	SAP → ST Cross talk	CTsap	ST	11	SAP 1kHz 100% mod. NR ON, Pilot (fH)	20 log ('NRSW = 1'/ 'NRSW = 0')	1kBPF	2	60	70	-	dB
22	SAP ON level	THsap	SAP	11	Change SAP Carrier (5fH) Level	0dB = 147mVrms		BUS RETURN	-12.0	-9.0	-6.5	dB
23	SAP ON/OFF hysteresis	HYsap				20 log ('on level'/ 'off level')			2.0	4.0	6.0	dB
24	ST separation 1 L → R	STLsep1	ST	11	ST-L 300Hz 30% mod. NR ON		15kLPF	1/2	23	35	-	dB
25	ST separation 1 R → L	STRsep1	ST	11	ST-R 300Hz 30% mod. NR ON		15kLPF	1/2	23	35	-	dB
26	ST separation 2 L → R	STLsep2	ST	11	ST-L 3kHz 30% mod. NR ON		15kLPF	1/2	23	35	-	dB
27	ST separation 2 R → L	STRsep2	ST	11	ST-R 3kHz 30% mod. NR ON		15kLPF	1/2	23	35	-	dB

Description of Operation

The US audio multiplexing system possesses the base band spectrum shown in Fig. 1.

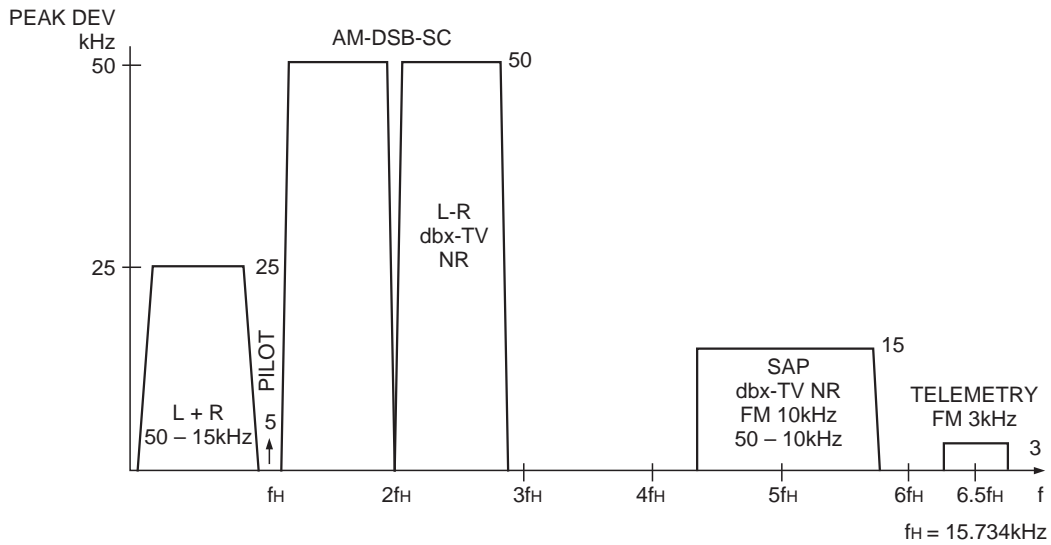

Fig. 1. Base band spectrum

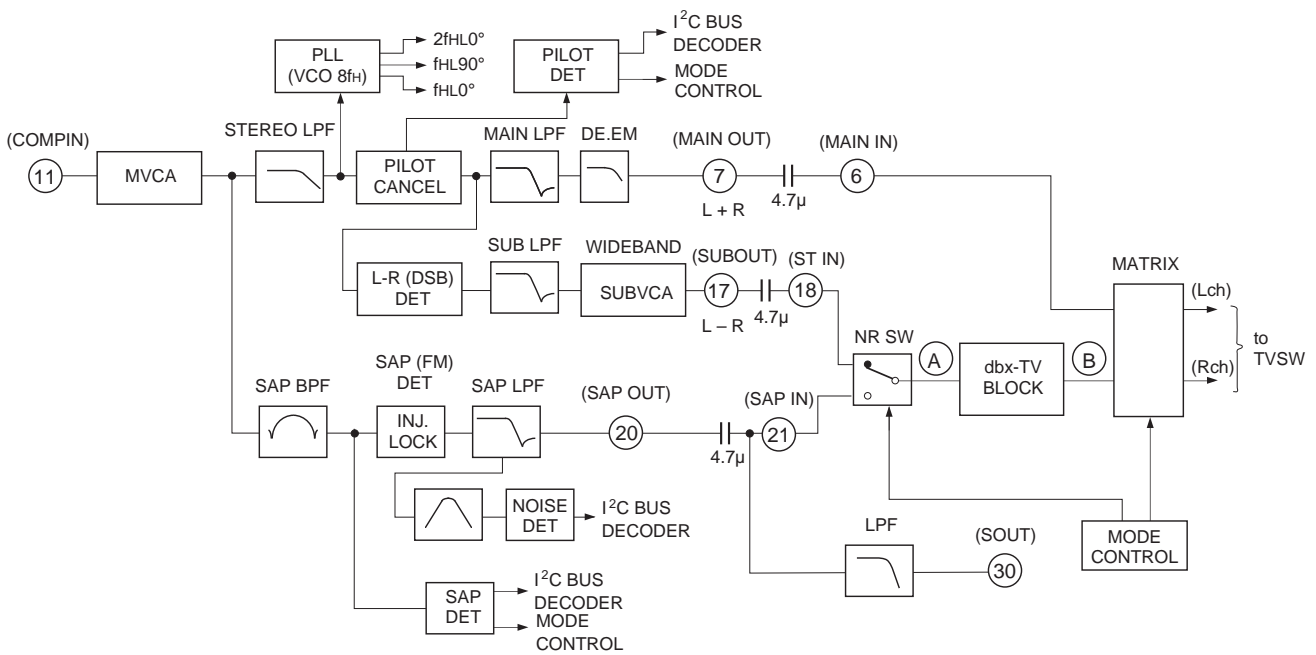

Fig. 2. Overall block diagram (See Fig. 3 for the dbx-TV block)

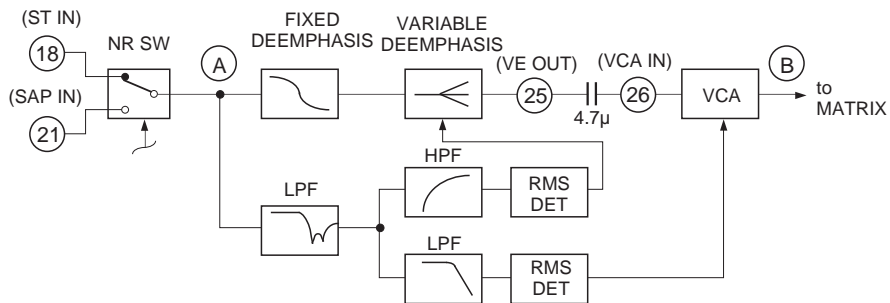

Fig 3. dbx-TV block

(1) L + R (MAIN)

After the audio multiplexing signal input from COMPIN (Pin 11) passes through MVCA, the SAP signal and telemetry signal are suppressed by STEREO LPF. Next, the pilot signals are canceled. Finally, the L – R signal and SAP signal are removed by MAIN LPF, and frequency characteristics are flattened (de-emphasized) and input to the matrix.

(2) L – R (SUB)

The L – R signal follows the same course as L + R before the pilot signal is canceled. L – R has no carrier signal, as it is a suppressed-carrier double-sideband amplitude modulated signal (DSB-AM modulated). For this reason, the pilot signal is used to regenerate the carrier signal (quasi-sine wave) to be used for the demodulation of the L – R signal. In the last stage, the residual high frequency components are removed by SUB LPF and the L – R signal is input to the dbx-TV block via the NRSW circuit after passing through SUBVCA.

(3) SAP

SAP is an FM signal using 5fH as a carrier as shown in the Fig. 1. First, the SAP signal only is extracted using SAP BPF. Then, this is subjected to FM detection. Finally, residual high frequency components are removed and frequency characteristics flattened using SAP LPF, and the SAP signal is input to the dbx-TV block via the NRSW circuit. When there is no SAP signal, the Pin 20 output is soft muted.

(4) Mode discrimination

Stereo discrimination is performed by detecting the pilot signal amplitude. SAP discrimination is performed by detecting the 5fH carrier amplitude. NOISE discrimination is performed by detecting the noise near 25kHz after FM detection of SAP signal.

(5) dbx-TV block

Either the L – R signal or SAP signal input respectively from ST IN (Pin 18) or SAP IN (Pin 21) is selected by the mode control and input to the dbx-TV block.

The input signal then passes through the fixed de-emphasis circuit and is applied to the variable de-emphasis circuit. The signal output from the variable de-emphasis circuit passes through an external capacitor and is applied to VCA (voltage control amplifier). Finally, the VCA output is converted from a current to a voltage using an operational amplifier and then input to the matrix.

The variable de-emphasis circuit transmittance and VCA gain are respectively controlled by Each of effective value detection circuits. Each of the effective value detection circuits passes the input signal through a predetermined filter for weighting before the effective value of the weighted signal is detected to provide the control signal.

(6) Matrix

The signals (L + R, L – R, SAP) input to "MATRIX" become the outputs for the ST-L, ST-R, MONO and SAP signals according to the mode control and whether there is ST / SAP discrimination.

(7) Others

"MVCA" is a VCA which adjusts the input signal level to the standard level of this IC.

"Bias" supplies the reference voltage and reference current to the other blocks. The current flowing to the resistor connecting IREF (Pin 13) with GND become the reference current.

Register Specifications

Slave address

SLAVE RECEIVER	SLAVE TRANSMITTER
84H (1000 0100)	85H (1000 0101)

Register table

SUB ADDRESS		DATA							
MSB	LSB	BIT7	BIT6	BIT5	BIT4	BIT3	BIT2	BIT1	BIT0
****0000		*		TEST-DA	TEST1	ATT (4)			
****0001		*		SPECTRAL (6)					
****0010		*		WIDEBAND (6)					
****0011		*		DATA1	DATA2	NRSW	FOMO	SAPC	M1
****0100		*		INSW	DATA5	ATT5W	FST	DATA3	DATA4

* : Don't Care

Status Registers

STA1	STA2	STA3	STA4	STA5	STA6	STA7	STA8
BIT7	BIT6	BIT5	BIT4	BIT3	BIT2	BIT1	BIT0
POWER ON RESET	STEREO	SAP	NOISE	—	—	—	—

Description of Registers

Control registers

Register	Number of bits	Classification*1	Standard setting	Contents
ATT	4	A	9	Input level adjustment
SPECTRAL	6	A	1F	Adjustment of stereo separation (3kHz)
WIDEBAND	6	A	1F	Adjustment of stereo separation (300Hz)
TEST-DA	1	T	0	Turn to DAC test mode by means of TEST-DA = 1.
TEST1	1	T	0	Turn to test mode by means of TEST = 1.
FST	1	T	0	Turn to forced stereo by means of FST = 1.
NRSW	1	U	—	Selection of the output signal (Stereo mode, SAP mode)
FOMO	1	U	—	Turn to forced MONO by means of FOMO = 1. (Left channel only is MONO during SAP output.)
M1	1	U	1	Selection of TVOUT mute ON/OFF (0: mute ON, 1: mute OFF)
ATTSW	1	S	—	Turn the input stage MVCA off when ATTSW = 1.
INSW	1	S	—	Selection of standard input level
SAPC	1	S	—	Selection of SAP mode or L + R mode according to the presence of SAP broadcasting
DATA1	1	T	0	Test mode (Normal standard setting value)
DATA2	1	T	0	
DATA3	1	T	0	
DATA4	1	T	0	
DATA5	1	T	0	

*1 Classification U: User control

A: Adjustment

S: Proper to set

T: Test

Status registers

Register	Number of bits	Contents
PONRES	1	POWER ON RESET detection; 1: RESET
STEREO	1	Stereo discrimination of the COMPIN input signal; 1: Stereo
SAP	1	SAP discrimination of the COMPIN input signal; 1: SAP
NOISE	1	Noise level discrimination of the SAP signal; 1: Noise

Description of Control Registers

ATT (4): Adjust the signal level input to COMPIN (Pin 11) to the standard input level.
Variable range of the input signal: standard input level -5.0dB to $+3.0\text{dB}$
0 = Level min.
F = Level max.

SPECTRAL (6): Perform high frequency ($f_s = 3\text{kHz}$) separation adjustment.
0 = Level max.
3F = Level min.

WIDEBAND (6): Perform low frequency ($f_s = 300\text{Hz}$) separation adjustment.
0 = Level min.
3F = Level max.

TEST-DA (1): Set DAC output test mode.
0 = Normal mode
1 = DAC output test mode
In addition, the following output are present at Pin 2.
TVOUT-L (Pin 2): DA control DC level

TEST1 (1): Monitor SAPBPF and NRBPF output
0 = Normal mode
1 = SAPBPF, NRBPF output
In addition, the following outputs are present at Pins 1 and 2.
TVOUT-L (Pin 2): SAP BPF OUT
TVOUT-R (Pin 1): NR BPF OUT

FST (1): Select forced STEREO mode
0 = Normal mode
1 = Forced stereo mode

NRSW (1): Select stereo mode or SAP mode
0 = Stereo mode
1 = SAP mode

- FOMO (1): Select forced MONO mode
0 = Normal mode
1 = Forced MONO mode
- M1 (1): Mute the TVOUT-L and TVOUT-R output.
0 = Mute ON
1 = Mute OFF
- ATTSW (1) Select BYPASS SW of MVCA
0 = Normal mode
1 = MVCA is passed
- INSW (1): Select standard input level of COMPIN (Pin 11).
0 = 245mVrms
1 = 100mVrms
- SAPC (1): Select the SAP signal output mode
When there is no SAP signal, the conditions for selecting SAP output are selected by SAPC.
0 = L + R output is selected
1 = SAP output is selected

Description of Mode Control

Mode control	SAPC = 0	SAPC = 1
NRSW	<p>“Select dbx input and TV decoder output” Conditions: FOMO = 0 NRSW = 0 (MONO or ST output)</p> <ul style="list-style-type: none"> • During ST input: left channel: L, right channel: R • During other input: left channel: L + R, right channel: L + R <p>NRSW = 1 (SAP output)</p> <ul style="list-style-type: none"> • When there is “SAP” during SAP discrimination – left channel: SAP, right channel: SAP • When there is “No SAP”, output is the same as when NRSW = 0. 	<p>“Select dbx input and TV decoder output” Conditions: FOMO = 0 NRSW = 0 (MONO or ST output)</p> <p>As on the left</p> <p>NRSW = 1 (SAP output)</p> <ul style="list-style-type: none"> • Regardless of the presence of SAP discrimination, dbx input: “SAP” left channel: SAP, right channel: SAP However, when there is no SAP, SAPOUT output is soft muted (–7dB)
FOMO	<p>“Forced MONO”</p>	
	<p>FOMO = 1</p> <ul style="list-style-type: none"> • During SAP output: left channel: L + R, right channel: SAP • During ST or MONO output: left channel: L + R, right channel: L + R 	
SAPC	<p>Change the selection conditions for “MONO or ST output” and “SAP output”.</p> <p>SAPC = 0: Switch to SAP output when there is SAP discrimination. Do not switch to SAP output when there is no SAP discrimination.</p> <p>SAPC = 1: Switch to SAP output regardless of whether there is SAP discrimination.</p>	
M1	<p>“MUTE”</p>	
	<p>M1 = 0: TVOUT output is muted.</p>	

Decoder Output and Mode Control Table 1 (SAPC = 1)

Input signal mode	Mode detection			Mode control			dbx input	Output	
	ST	SAP	NOISE	NRSW	FOMO	SAPC		Lch	Rch
MONO *1	0	0	0	0	*	1	MUTE	L + R	L + R
	0	0	0	1	0	1	SAP	SAP	SAP
	0	0	0	1	1	1	SAP	L + R	SAP
	0	*	1	0	*	1	MUTE	L + R	L + R
	0	*	1	1	0	1	(SAP)	(SAP)	(SAP)
	0	*	1	1	1	1	(SAP)	L + R	(SAP)
STEREO *1	1	0	*	0	0	1	L - R	L	R
	1	0	*	0	1	1	MUTE	L + R	L + R
	1	1	1	0	0	1	L - R	L	R
	1	1	1	0	1	1	MUTE	L + R	L + R
	1	0	0	1	0	1	SAP	SAP	SAP
	1	0	0	1	1	1	SAP	L + R	SAP
	1	*	1	1	0	1	(SAP)	(SAP)	(SAP)
	1	*	1	1	1	1	(SAP)	L + R	(SAP)
MONO & SAP	0	1	*	0	0	1	MUTE	L + R	L + R
	0	1	*	0	1	1	MUTE	L + R	L + R
	0	1	0	1	0	1	SAP	SAP	SAP
	0	1	0	1	1	1	SAP	L + R	SAP
	0	1	1	1	0	1	(SAP)	(SAP)	(SAP)
	0	1	1	1	1	1	(SAP)	L + R	(SAP)
STEREO & SAP	1	1	*	0	0	1	L - R	L	R
	1	1	*	0	1	1	MUTE	L + R	L + R
	1	1	0	1	0	1	SAP	SAP	SAP
	1	1	0	1	1	1	SAP	L + R	SAP
	1	1	1	1	0	1	(SAP)	(SAP)	(SAP)
	1	1	1	1	1	1	(SAP)	L + R	(SAP)

Note

(SAP) : The SAPOUT output signal is soft muted (approximately -7dB).

The signal is soft muted when NOISE = 1.

* : Don't care.

*1 SAP or NOISE discrimination may be made during MONO or STEREO input when the noise is inputted in the weak electric field.

Then microcomputer reads "NOISE" status from IC and decides whether SAP is outputted.

"NOISE" status rises earlier than "SAP" status when the amount of noise is increased to COMPIN.

Decoder Output and Mode Control Table 2 (SAPC = 0)

Input signal mode	Mode detection			Mode control			dbx input	Output	
	ST	SAP	NOISE	NRSW	FOMO	SAPC		Lch	Rch
MONO *1	0	0	*	*	*	0	MUTE	L + R	L + R
	0	1	1	0	0	0	MUTE	L + R	L + R
	0	1	1	0	1	0	MUTE	L + R	L + R
	0	1	1	1	0	0	(SAP)	(SAP)	(SAP)
	0	1	1	1	1	0	(SAP)	L + R	(SAP)
STEREO *1	1	0	*	0	0	0	L - R	L	R
	1	0	*	0	1	0	MUTE	L + R	L + R
	1	0	*	1	0	0	L - R	L	R
	1	0	*	1	1	0	MUTE	L + R	L + R
	1	1	1	0	0	0	L - R	L	R
	1	1	1	0	1	0	MUTE	L + R	L + R
	1	1	1	1	0	0	(SAP)	(SAP)	(SAP)
MONO & SAP	0	1	0	0	0	0	MUTE	L + R	L + R
	0	1	0	0	1	0	MUTE	L + R	L + R
	0	1	0	1	0	0	SAP	SAP	SAP
	0	1	0	1	1	0	SAP	L + R	SAP
	0	1	1	0	0	0	MUTE	L + R	L + R
	0	1	1	0	1	0	MUTE	L + R	L + R
	0	1	1	1	0	0	(SAP)	(SAP)	(SAP)
	0	1	1	1	1	0	(SAP)	L + R	(SAP)
STEREO & SAP	1	1	0	0	0	0	L - R	L	R
	1	1	0	0	1	0	MUTE	L + R	L + R
	1	1	0	1	0	0	SAP	SAP	SAP
	1	1	0	1	1	0	SAP	L + R	SAP
	1	1	1	0	0	0	L - R	L	R
	1	1	1	0	1	0	MUTE	L + R	L + R
	1	1	1	1	0	0	(SAP)	(SAP)	(SAP)
	1	1	1	1	1	0	(SAP)	L + R	(SAP)

Note

(SAP) : The SAPOUT output signal is soft muted (approximately -7dB).

The signal is soft muted when NOISE = 1.

* : Don't care.

*1 SAP or NOISE discrimination may be made during MONO or STEREO input when the noise is inputted in the weak electric field.

Then microcomputer reads "NOISE" status from IC and decides whether SAP is outputted.

"NOISE" status rises earlier than "SAP" status when the amount of noise is increased to COMPIN.

I²C BUS block items (SDA, SCL)

No.	Item	Symbol	Min.	Typ.	Max.	Unit
1	High level input voltage	V _{IH}	3.0	—	5.0	V
2	Low level input voltage	V _{IL}	0	—	1.5	
3	High level input current	I _{IH}	—	—	10	μA
4	Low level input current	I _{IL}	—	—	10	
5	Low level output voltage SDA (Pin 3) during 3mA inflow	V _{OL}	0	—	0.4	V
6	Maximum inflow current	I _{OL}	3	—	—	mA
7	Input capacitance	C _I	—	—	10	pF
8	Maximum clock frequency	f _{SCL}	0	—	100	kHz
9	Minimum waiting time for data change	t _{BUF}	4.7	—	—	μs
10	Minimum waiting time for start of data transfer	t _{HD: STA}	4.0	—	—	
11	Low level clock pulse width	t _{LOW}	4.7	—	—	
12	High level clock pulse width	t _{HIGH}	4.0	—	—	
13	Minimum waiting time for start preparation	t _{SU: STA}	4.7	—	—	
14	Minimum data hold time	t _{HD: DAT}	0	—	—	ns
15	Minimum data preparation time	t _{SU: DAT}	250	—	—	
16	Rise time	t _R	—	—	1	μs
17	Fall time	t _F	—	—	300	ns
18	Minimum waiting time for stop preparation	t _{SU: STO}	4.7	—	—	μs

I²C BUS load conditions: Pull-up resistor 4kΩ (Connect to +5V)
 Load capacity 200pF (Connect to GND)

I²C BUS Control Signal

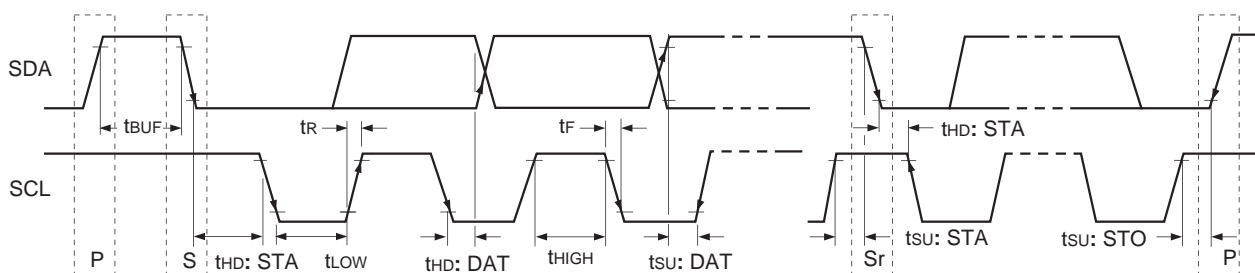

I²C BUS Signal

There are two I²C signals, SDA (Serial DATA) and SCL (Serial CLOCK) signals. SDA is a bidirectional signal.

- Accordingly there are 3 values outputs, H, L and HIZ.

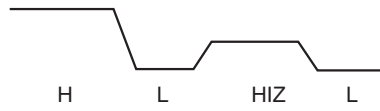

- I²C transfer begins with Start Condition and ends with Stop Condition.

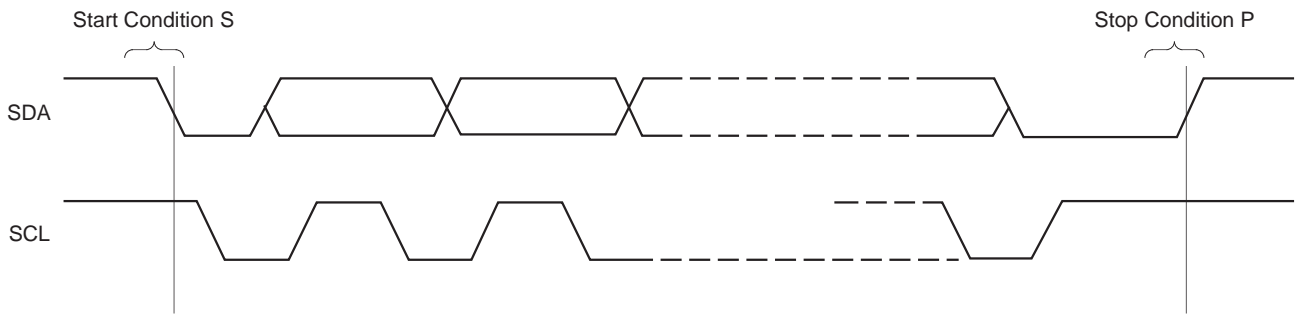

• I²C data Write (Write from I²C controller to the IC)

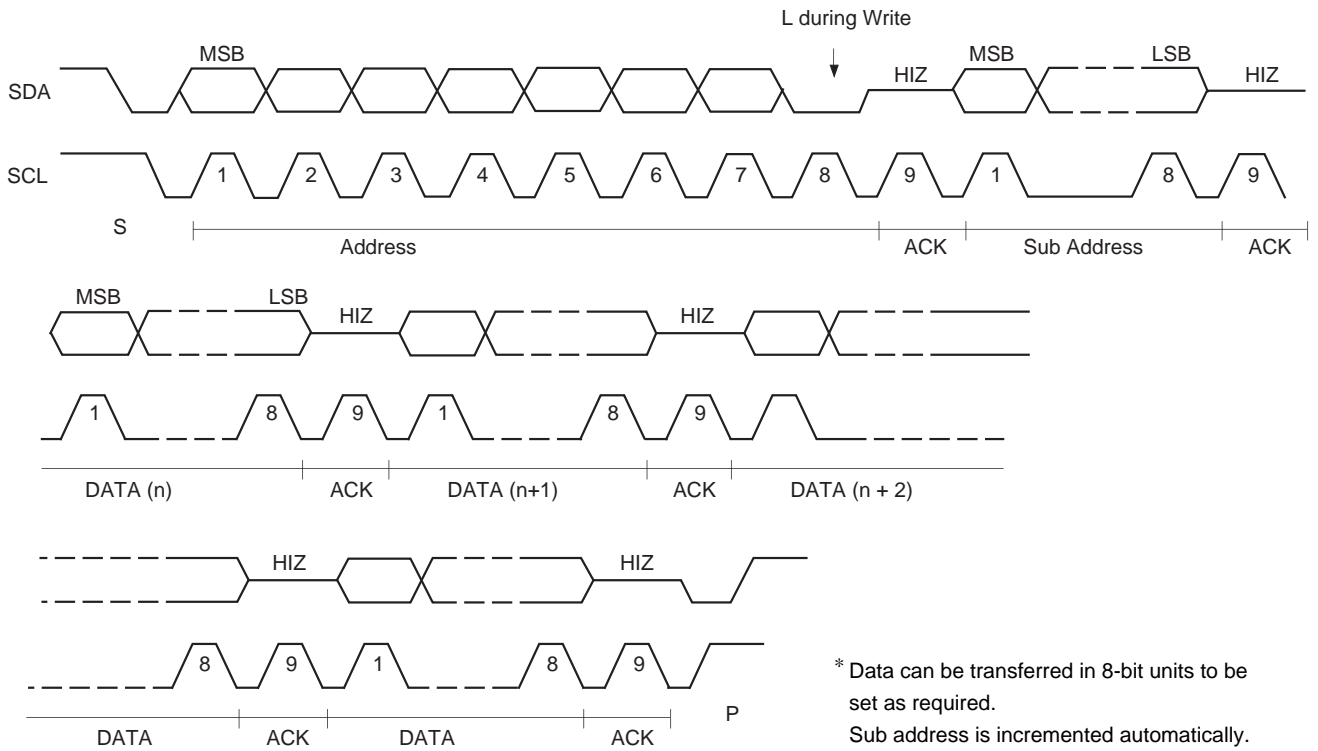

• I²C data Read (Read from the IC to I²C controller)

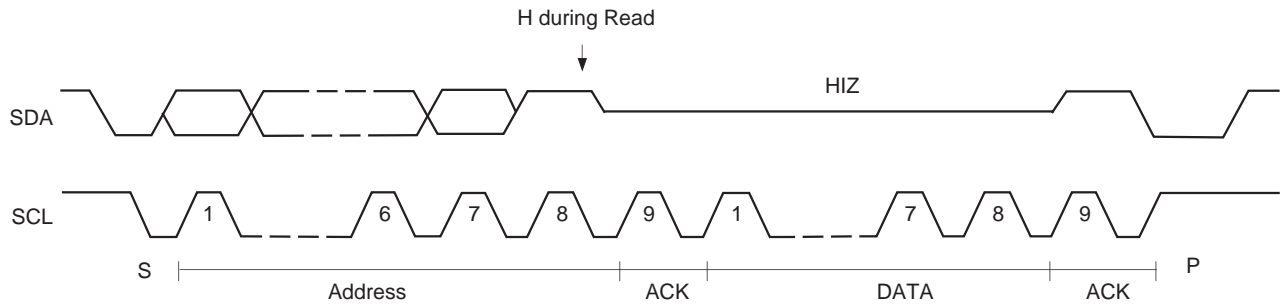

• Read timing

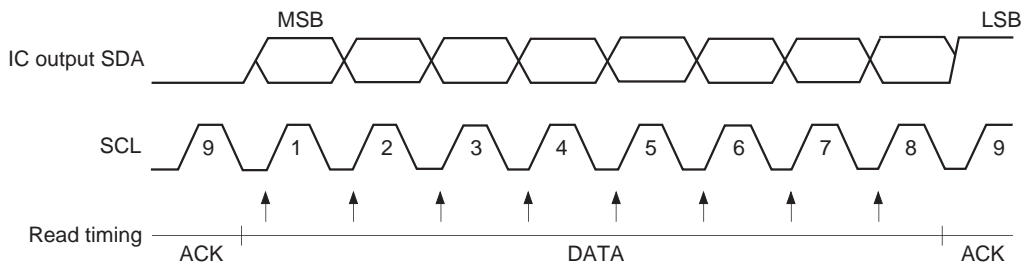

* Data Read is performed during SCL rise.

Input level vs. Distortion characteristics 1 (MONO)

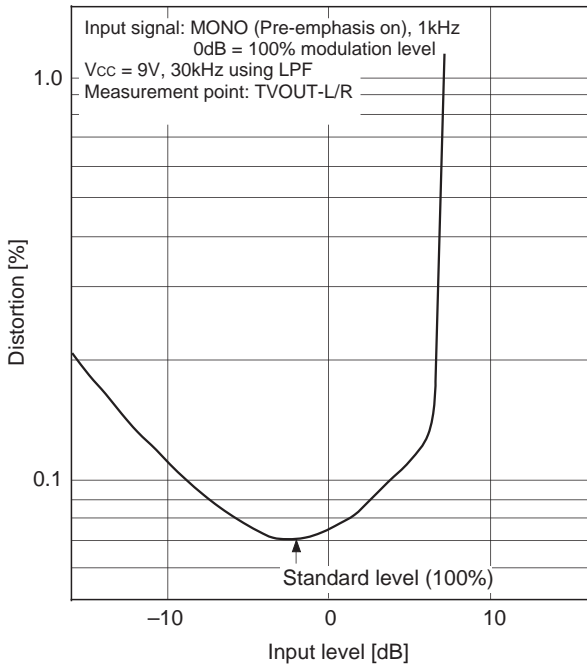

Input level vs. Distortion characteristics 2 (Stereo)

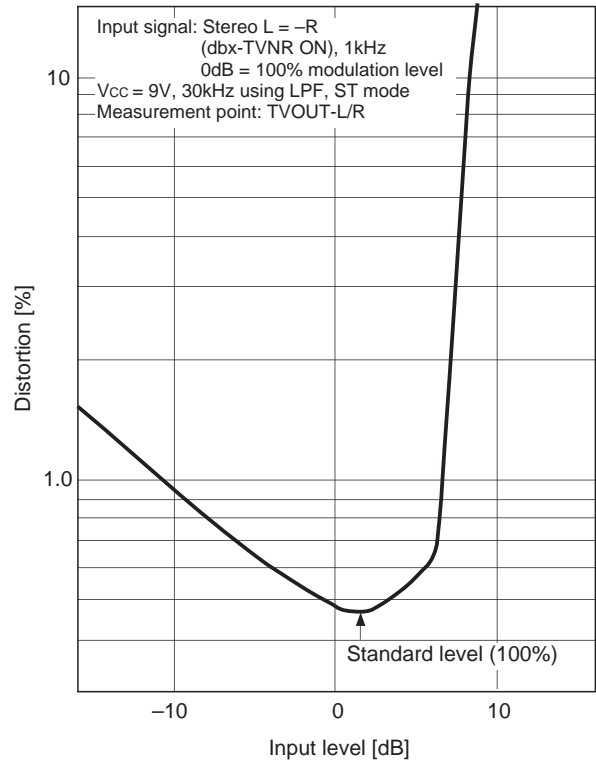

Input level vs. Distortion characteristics 3 (SAP)

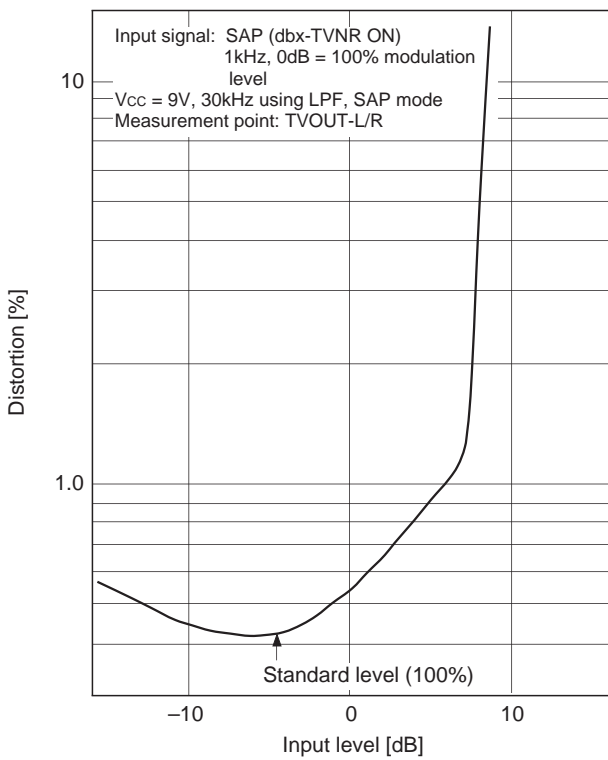

Stereo LPF frequency characteristics

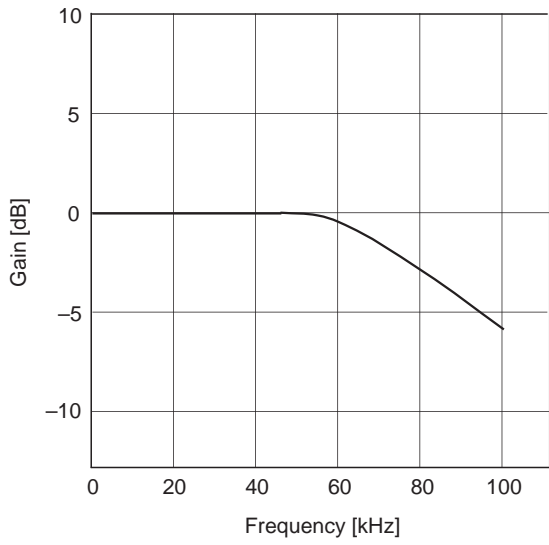

Main LPF and Sub LPF frequency characteristics

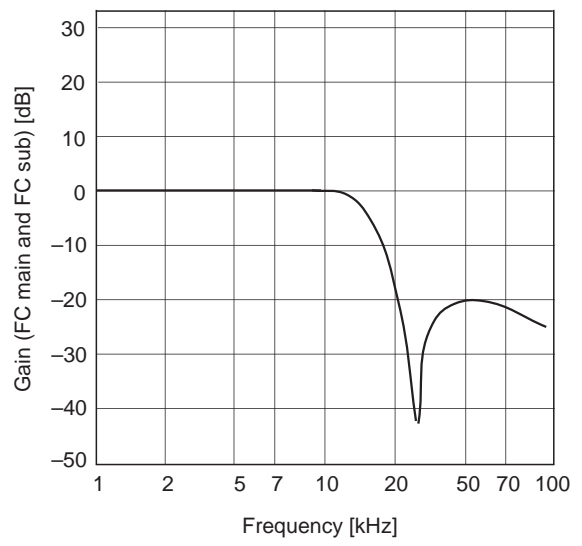

SAP frequency characteristics and group delay

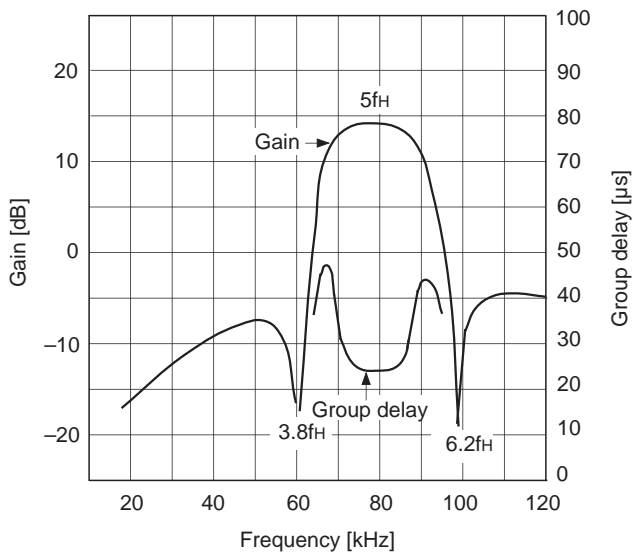

Additional SAP frequency characteristics

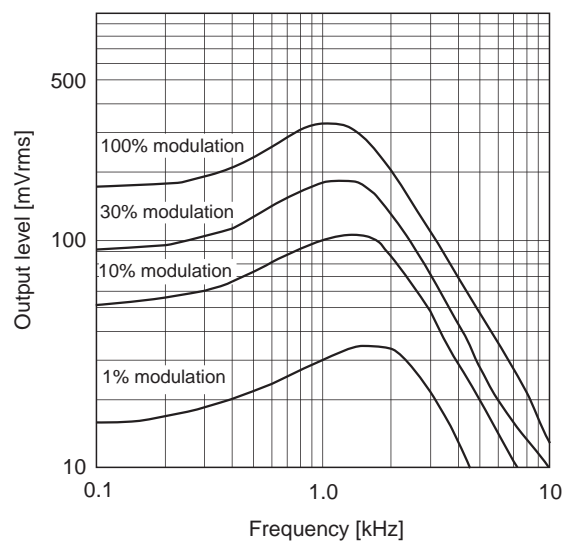

Package Outline Unit: mm

30PIN SDIP (PLASTIC)

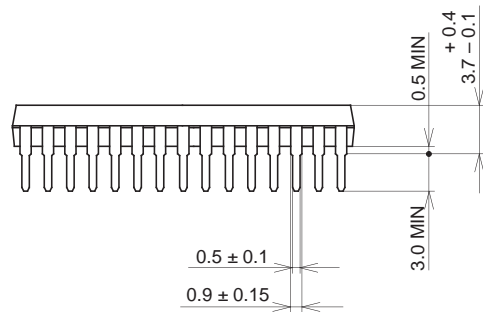
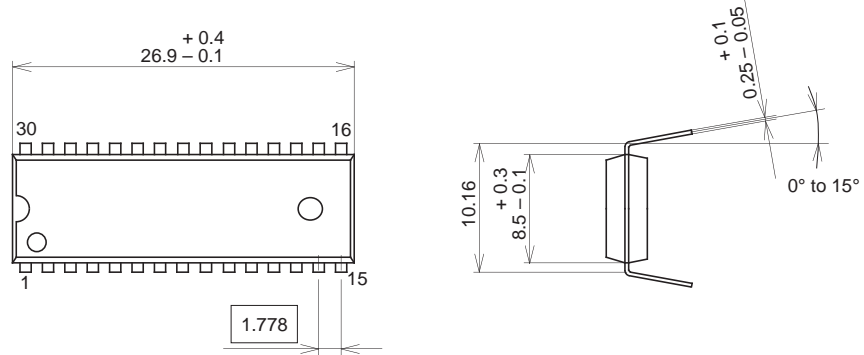

Two kinds of package surface:
 1. All mat surface type.
 2. All mirror surface type.

PACKAGE STRUCTURE

SONY CODE	SDIP-30P-01
EIAJ CODE	SDIP030-P-0400
JEDEC CODE	—

MOLDING COMPOUND	EPOXY RESIN
LEAD TREATMENT	SOLDER/PALLADIUM PLATING
LEAD MATERIAL	COPPER ALLOY
PACKAGE MASS	1.8g

NOTE : PALLADIUM PLATING
 This product uses S-PdPPF (Sony Spec.-Palladium Pre-Plated Lead Frame).